

D

OWNER'S MANUAL



Delphia 33

Copyright law

©2008 Delphia Yachts technical data. All rights reserved. This manual was written in accordance with the standards of International Standard Organisation (ISO) 10240:2004. This manual and none of its components including text, illustrations and tables cannot be reproduced in any other form without written permission from Delphia Yachts under the threat of violation of copyright law. The use of information included in this manual is not restricted by patent laws.

Delphia 33 - Owner's manual

First edition - January 2008

Printed in Poland.

Reservations regarding legal responsibility

The substantive content of this owner's manual was checked and approved. This means that the instructions and Delphia yachts descriptions included in it were up to date during their production. The next versions of boats and manuals may change without former notification. Delphia Yachts Company is not responsible for any disservice resulting directly or indirectly from the mistakes, omissions and discrepancies existing between the real boat and information included in this manual.

Trademarks

Delphia is a reserved trademark of Delphia Yachts Sp. Jawna. In the manual may also appear another trademarks and registered trademarks not mentioned above.

Serial number:.....



YOUR BOAT

VERSION
NAME OF THE BOAT
NAME OF THE OWNER
ADDRESS
.....
.....
HIN NUMBER
REGISTRATION NUMBER
DELIVERY DATE
KEY NUMBER
ENGINE
ENGINE SERIAL NUMBER
ENGINE KEY NUMBER

Your agent



DELPHIA YACHTS KOT sp.j. ul. Kościuszki 63 19-400 Olecko -POLAND
Tel. 087 520 30 37 Fax 087 520 21 77
internet : <http://www.delphiayachts.pl>

TABLE OF CONTENT

Delphia 33
update 01.03.2008r

Total number of pages: 99

INTRODUCTION

Chapter 1.....page 2

SPECIFICATION

Chapter 2.....page 6

SAFETY

Chapter 3.....page 8

DECK AND HULL

Chapter 4.....page 12

RIGGING AND SAILS

Chapter 5.....page 21

CABINS

Chapter 6.....page 30

INSTALLATIONS

Chapter 7.....page 33

ENGINE

Chapter 8.....page 49

ELECTRIC SYSTEM

Chapter 9.....page 61

LAUNCHING

Chapter 10.....page 90

WINTER STORAGE

Chapter 11.....page 91

ENVIRONMENT PROTECTION

Chapter 12.....page 93

WARRANTY

Chapter 13.....page 94

PERSONAL NOTES

At the end of the manual

EXTRAS

CD ROM including owner's manual and detailed electric system schemes in PDF format.



INTRODUCTION

You have just been delivered a brand new Delphia 33. First of all we would like to thank You for your trust and the choice of one of our products. Each our yacht is the subject of our particular care in the smallest detail, beginning from the project, until the moment of shipment and launching of the yacht. All of these is done in order to give you joy and delight for many years.

We share the common passion for the sea: we, Delphia Yachts as a shipbuilders and You, who want to live your passion on the Seven Seas.

We are delighted to welcome You to the great family of Delphia Yachts boat owners.

This manual was meant to help You to enjoy your boat comortably and safely. It includes the boat specifications, the equipment, the systems and tips on her operation and maintenance. Some of the equipment elements may be optional.

We keep improving our boats as we want You to benefit from the technological developments, new equipment or materials and our own experience. This is the reason why the specifications and information given are not contractual, they may be modified without prior notification or update.

Our network of Delphia Yachts authorized dealers will be at your disposal to help You to get acquainted with your boat and will be the most qualified to take care of her maintenance.

Even if your boat has been appropriately assigned to a category, the sea conditions and the wind relating to a category A, B and C are changeable and depend on the hazards of unusually strong waves or gusty winds. In such conditions only an experienced, very fit and well equipped crew can sail satisfactory.

ADVICE

Please make sure that the sea and wind conditions will correspond to the category of your boat and you and your crew are able to handle the boat in these conditions.

This manual is not the course in safety sailing or sailing in general. If it is your first boat or if you change to a new type of boat, which you are not used to, get some training in boat control and sailing to ensure your safety and comfort. Your dealer, your international sailing association or your yacht club will be very happy to recommend you local sailing schools or professional instructor.

This manual is not a detailed instruction maintenance or repair. In case of any problems do not hesitate to contact the producer of the boat or one of his dealers.

The users of the boat are informed of the following:

- The entire crew must be trained properly.
- In some countries a licence or a training course is requested. Make sure you have this before you use the boat.
- You should always keep the boat in good conditions and take into account that it wears out with time and inappropriate use.
- Any boat, however solid it may be, may be severely damaged if badly used. This is not compatible with a secure navigation. Always adjust the speed and direction of the boat to the conditions of the sea.
- If your boat is equipped with a liferaft, read the instruction carefully. The crew should be familiar with the use of all safety equipment (harness, flares, liferaft, etc.) and the emergency safety procedures (MOB, towing, etc.). Sailing schools and yacht clubs organize such courses regularly.
- You are not allowed to sail at the maximum speed in busy areas or in case of low visibility, strong wind or vast waves. Then you should reduce the speed and change the direction of the boat taking into account your own and others' safety.
- You should obey the 'COLREG', the steering and course regulation rules as it is described and published by International Maritime Organization. These are the international regulations in order to prevent collision at sea.
- Make sure if there is enough place for stopping the boat or manoeuvre in order to prevent the collision.

Always use an experienced technician for the maintenance of your boat and introducing any modification.

All the changes which may affect the safety of the boat should be evaluated and carried out by competent people. The shipbuilder cannot be responsible for the changes which were not approved.

ATTENTION !

All the changes of the deck load (eg. Adding a lifted platform for fishing, a radar, mast drop system, changing the engine, etc.) may affect the stability of the boat.



The information regarding the maintenance included in this manual works as a tips for a boat owner during the normal exploitation of the boat in typical conditions.

Climate and the methods of use may change and may need additional or special maintenance. Contact your local Delphia Yachts dealer in order to get the information regarding the appropriate maintenance and safety precautions advised for your type of use and climate.

The appropriate maintenance of your boat may give you a lot of satisfaction during during sailing activities. Regular control is the best preservation. It helps to secure the boat and maintain it in good condition during the exploitation and comforts you when you cannot take care of the yacht.

KEEP THIS MANUAL IN A SAFE PLACE AND HAND IT OVER TO THE NEW OWNER IF YOU SELL YOUR BOAT

SPECIFICATION

| | |
|--|--|
| Length of hull {m}..... | 10,40 |
| Width of hull {m}..... | 3,47 |
| Length KLW {m}..... | 9,06 |
| Width KLW {m}..... | 2,73 |
| Draft to KLW {m}..... | 1,77 |
| Height over KLW {m}..... | 15,40 |
| Boat weight {kg}..... | 5200 |
| Maximum load {kg}..... | 995 |
| Ballast {kg}..... | 1330 |
| Additional engine power max (KW/HP)..... | 22/45 |
| Fuel tank (litres)..... | 125 |
| Water tank (litres)..... | 210 |
| Waste water tank (litres)..... | 45 |
| Batteries capacity (Amph)..... | 2x105 +1x75 (12V) |
| Maximum number of people..... | 6 |
| Architect..... | Andrzej Skrzat Delphia Yachts Designer |

Sails

| | |
|---|-------|
| Full battened mainsail with two reefs {m ² } | 29,00 |
| Furling genoa {m ² }..... | 32,00 |
| Spinnaker {m ² }..... | 60,00 |
| P {m}..... | 12,90 |
| E {m}..... | 4,10 |
| I {m}..... | 13,00 |
| J {m}..... | 3,68 |

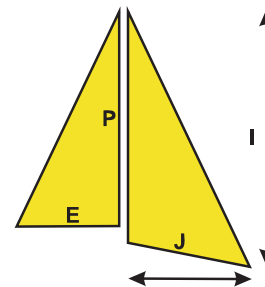

Certificates and Project Category

DELPHIA 33 was certified (CE) in Polish Ship Registry (PRS) and Germanischer Lloyd. The procedures for module Aa according to directive 94/25/WE. The inspection of the unit was in accordance with the norm PN-EN ISO 12217-2 in the sphere:

- Stability and freeboard
- Displacement and buoyancy

The hull identification number placed on the transom starboard.

DELPHIA 33 has a project category A for 6 people.

Category A - „oceanic”: A unit designed for long cruises, during which can appear such conditions when the wind force exceeds 8 degrees in Beaufort scale and the significant height of waves is more than 4 metres. It refers to self-sufficient units.

ATTENTION !

Do not exceed the advised maximum number of people. Regardless the number of people on the boat, The maximum weight of people and the equipment cannot exceed the maximum load capacity recommended by the boatbuilder. Always use the seats.



ATTENTION !

When loading a boat, never exceed the maximum load capacity. Do it carefully and distribute the load properly in order to get a level draft. Avoid placing the heavy objects in high positions.



SAFETY

WARNING !

- before you sail, list the compulsory safety equipment
- do not exceed the maximum number of persons indicated in the chapter SPECIFICATIONS;
- when you do not take into account the maximum number of people, the total weight of the people and the equipment you may exceed maximum load recommended by the manufacturer which cause a great danger



RECOMMENDATION

Close the deck hatches and fore escape hatch before each sailing trip. In case of heavy weather close companion hatch.

LOCATION OF THE FIRE EXTINGUISHERS AND EMERGENCY EXITS

ATTENTION!

The fire extinguishers are part of the compulsory equipment.



There are two dry powder extinguishers on D-33, automatic and manual:

- automatic (1 kg, A26/40)
- manual (2 kg, 13A 89B)



- FIRE EXTINGUISHERS

1. Automatic - under the stairs,
on the engine compartment cover.
2. Manual - in the messroom under the seat.



- EMERGENCY EXITS

- A. Deck hatch of the fore cabin.
- B. Companionway.

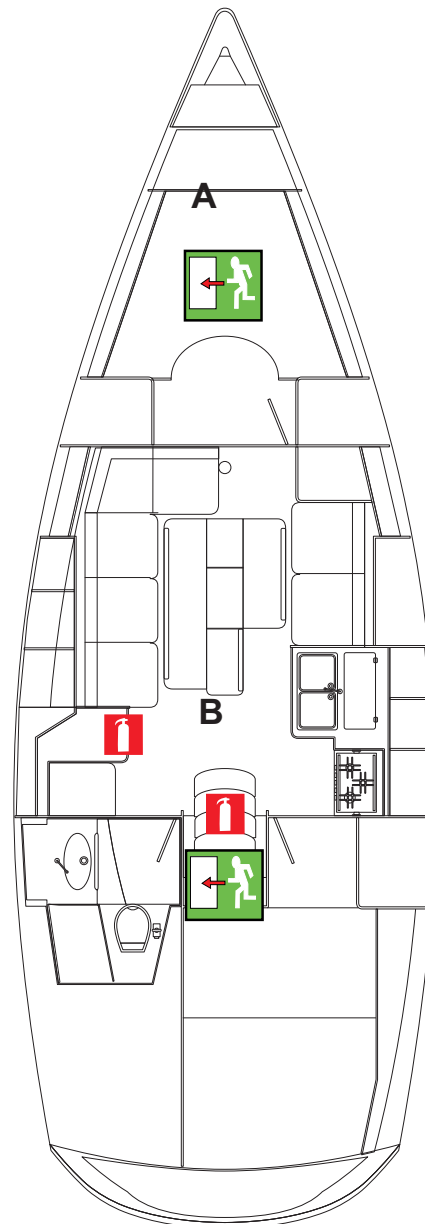

The owner's or skipper's duty is:

- to check the extinguisher according to the information included in the manual;
- to replace the extinguisher, which is empty or expired;
- to inform the crew where the extinguishers is and how to use it;
- to tell the crew how to behave in case of a fire;

ATTENTION !

NEVER:

- obstruct the way to emergency exits;
- obstruct the access to safety controls (fuel valve, gas valve, power switches)
- obstruct the access to the fire extinguishers;
- leave a boat unattended when gas appliances are working;
- use gas lamps in the boat;
- modify the boat systems (electricity, gas or fuel);
- change a gas cylinder when an engine is running;
- smoke while handling fuel or gas



ATTENTION!

When sailing always wear a life jacket. In heavy weather conditions use safety belts and life lines.



EMERGENCY TILLER

The emergency tiller is in one of a stern lockers. Make sure that there is an easy access to the tiller.

How to use the tiller:

1. Unscrew the cover of rudder bearing situated under the seat at the back of the cockpit using a winch handle (photo 1).
2. Insert the tiller into a rudder stock.
3. Make sure that it is properly mounted.

1. Winch handle



2. Emergency tiller



Advice

The emergency tiller should be used only in case of a steering wheel failure. It was designed only for this purpose that is why the speed should be reduced when using the tiller.

DECK AND HULL

The construction of the yacht is based on fiber-glass reinforced plastic shell technology. It consists of three main shells, the deck shell, the hull shell and the construction frame shell. In addition there is counter ceiling shell, two sanitary cabin shells and small equipment shells. All of them are monolithic constructions and partly stacking core constructions. The stacking core is a foam Airex type. All the hull elements are permanently joined together with a glue and fiber glass reinforced plastic. In places which carry a heavy load the construction was reinforced with duraluminium plates. All elements made of wood were protected with a varnish. All elements made of fiber-glass plastic were protected from water on influence outside with a special polyester resin called gelcoat, and from inside with polyester resin called topcoat.

DECK

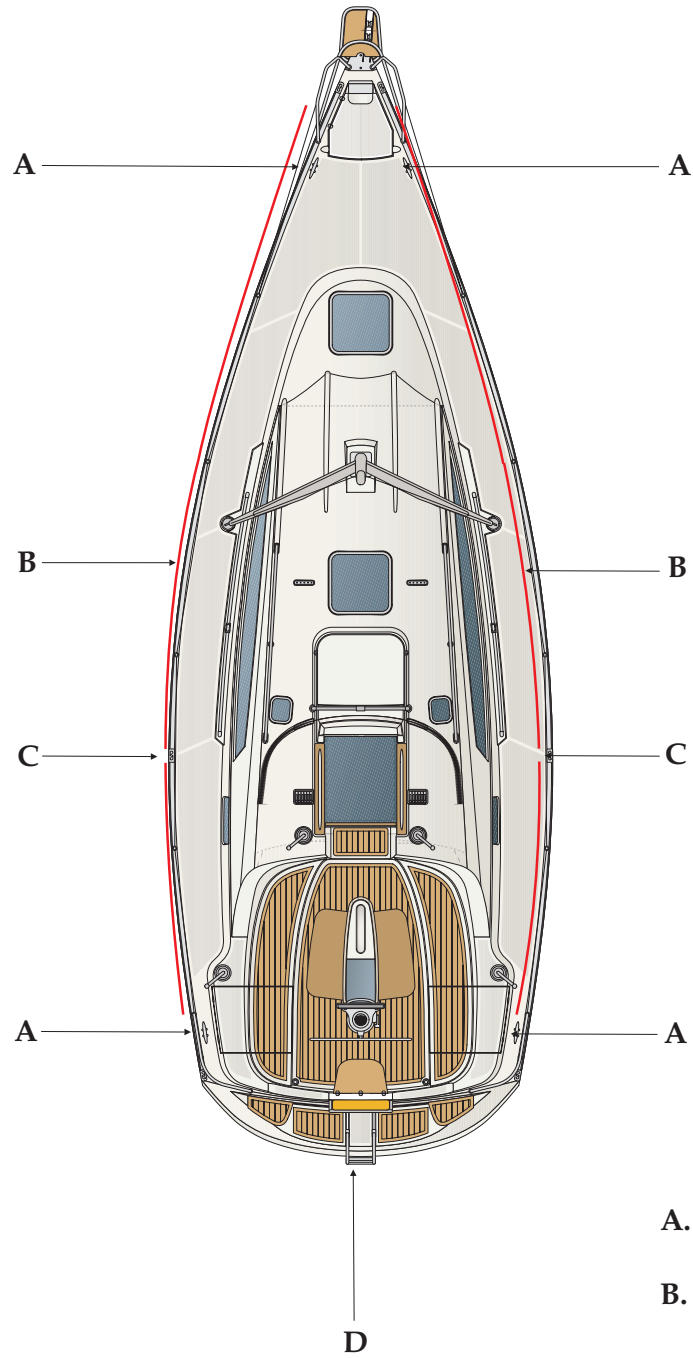

- A. Cleats
- B. Life lines
- C. Chocks
- D. Ladder

MOORING

The proper number of accurate mooring ropes suitably sized and suitable for the environment shall be on board for mooring the boat.

When mooring you should:

- always manoeuvre your boat using the engine;
- take into account the current wind and tide;
- handle your boat carefully at a reduced speed.

Always keep the mooring lines in clean and dry place.

DANGER !

Do not try to stop your boat by your foot or hand when mooring!



TOWING

Towing another boat:

- pay particular attention when you throw or catch the towing rope;
- tow another boat at a reduced speed and as smoothly as you can.

When you are towed:

- handle your boat gently and try to stay in the wake of the towing boat.

ANCHORING SYSTEM

- D- 33 is equipped with anchoring system consisting of:
- 15 kgs Delta anchor;
 - windlass;
 - 50 metres anchor chain.

ATTENTION !

There should be two crew members during the lowering of the anchor:

- one operating the engine control panel;
- one operating the windlass joystick.



WARNING !

Before anchoring check the depth of water, the power of the current and the structure of the sea bed.



WARNING !

Do not stop the engine when anchoring in order to avoid discharging of the batteries.



Lowering the anchor

Stop the boat and stand aline the wind. Going back slowly start lowering the anchor using the windlass.

In order to start the windlass you should turn on **house** master switch + main windlass securing. After turning them on you should go to the bow part of the boat and lower the anchor using the joystick.

Lifting the anchor

Make sure that the chain is properly placed on the lift. Start the engine and moving slowly lift the anchor up. After lifting it up you can turn off the windlass securing. If you know that you will not use the anchor for a long time you can place it in the anchor chamber.

MAINTENANCE OF THE DECK

First of all, the boat should be washed on shore in order not to contaminate the water.

Do not use aggressive detergents to wash your boat.

Wash the deck regularly using the water with addition of degreasing cleaning agents which you can buy in a marine store. Use as few cleaning agents as possible.

DECK FITTINGS

Clean all the deck equipment with fresh water. Periodically lubricate blocks, travellers, etc. with a water-repellent grease. Clean and polish the stainless steel parts.

TEAK

Regularly clean the woodworks with fresh water and sponge.

ATTENTION!

Do not use a pressure washer for cleaning the teak parts.



PLEXIGLASS

Rinse plexiglas with fresh water.

Brighten up with a soft rag soaked with liquid parafin.

Use polish paste to remove scratches.

ATTENTION !

Never use solvent, alcohol, acetone and any other liquids based on these substances to rinse plexiglas.



STEERING SYSTEM

The boat is equipped with either steering pedestal or steering tiller. The rudder is placed under the bottom of the boat and is handled from the cockpit. The rudder blade is made of fiber-glass reinforced plastic.

STEERING WHEEL VERSION

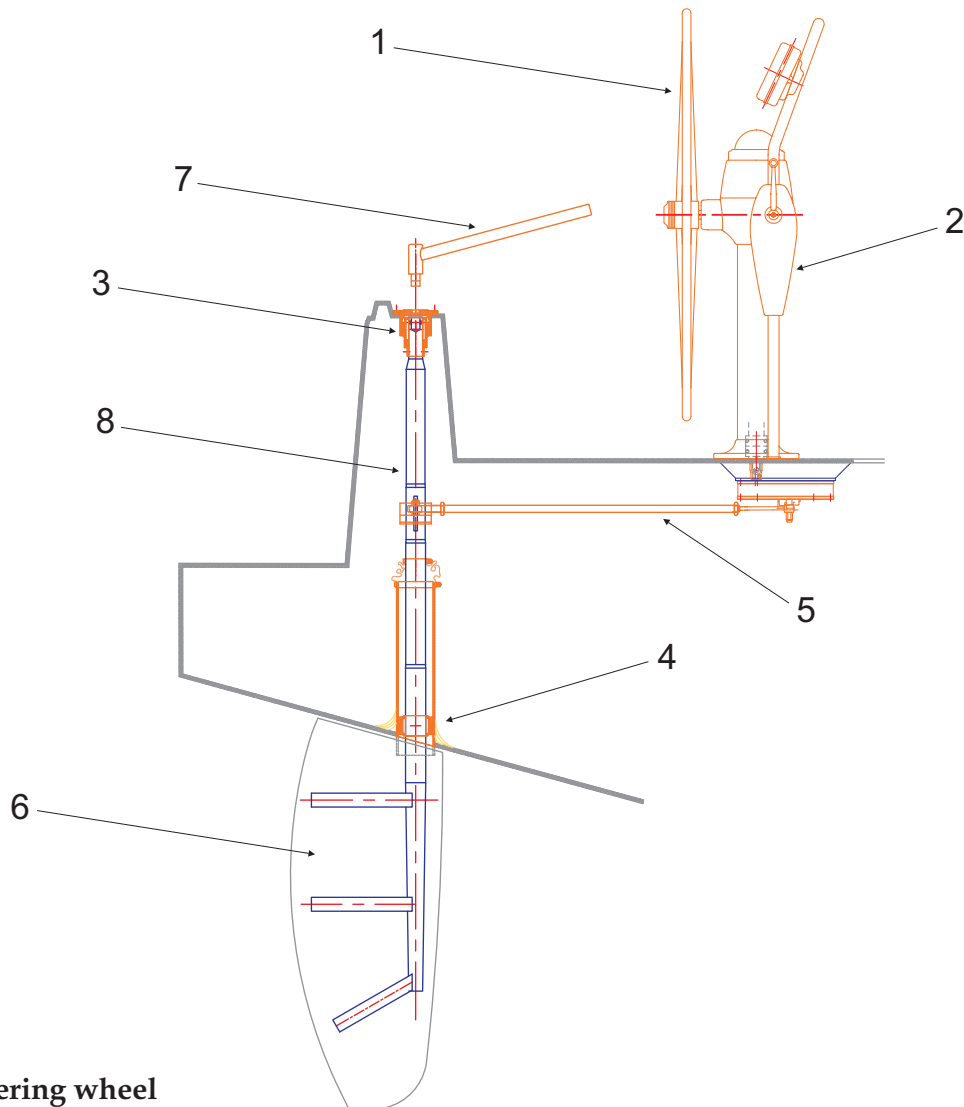

1. Steering wheel
2. Steering pedestal
3. Rudder stock upper bearing (emergency tiller mounting place)
4. Rudder stock lower bearing
5. Crow-bar
6. Rudder blade
7. Emergency tiller
8. Rudder stock

TILLER VERSION

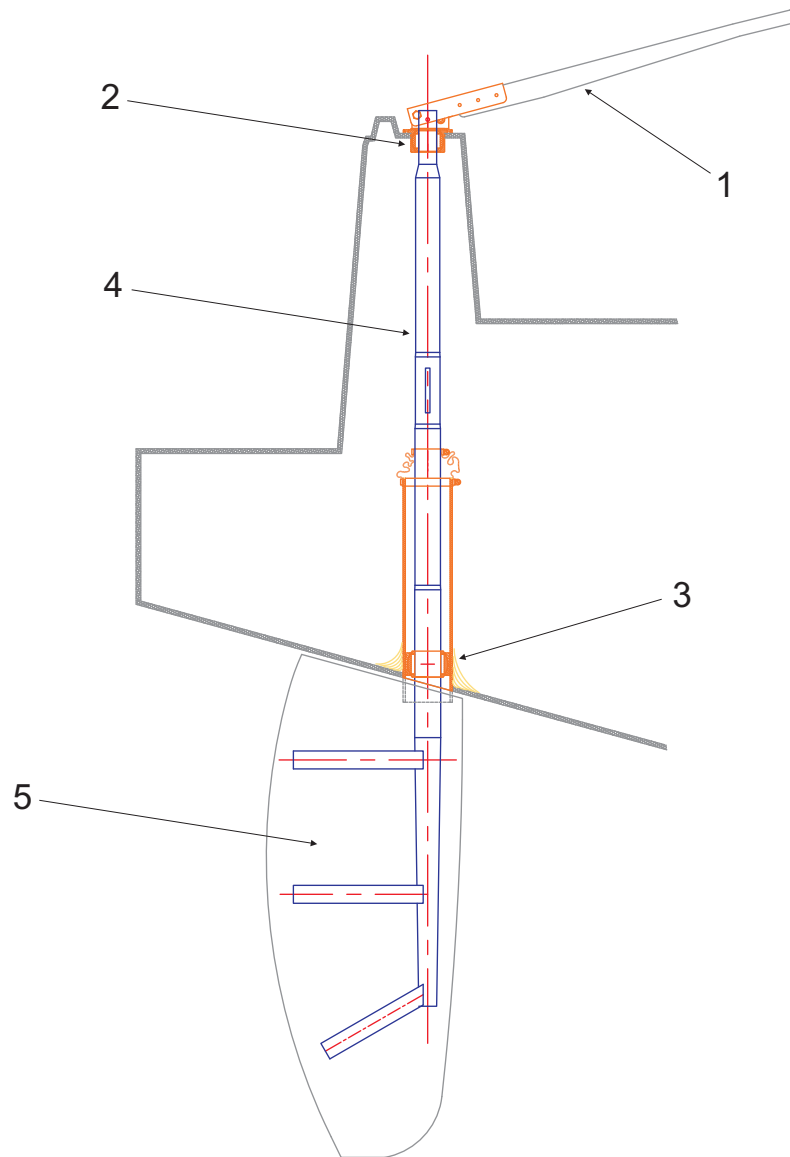

1. Tiller
2. Rudder stock upper bearing
3. Rudder stock lower bearing
4. Rudder stock
5. Rudder blade

A dark red L-shaped line in the top-left corner of the page.

HULL

MAINTENANCE OF THE HULL

The materials and the equipment of your boat are of the best quality in order to be the most functional and easy to maintain. They have been chosen to protect the outer layer of the hull from outside attacks (salt, sun, electrolysis, etc.). This means that the minimum maintenance is enough to keep the hull in perfect condition.

If it is possible, wash your boat on shore.

Use as few cleaning agents as possible.

Do not use aggressive detergent agents or solvents.

Do not discharge your cleaning products into the water.

ANTIFOULING

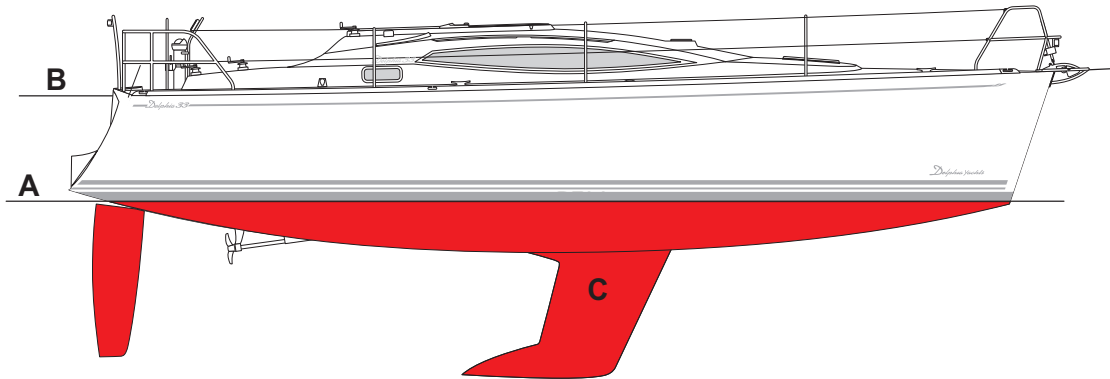

- A- water line
- B- deck line
- C- antifouling (red colour)

The underwater part of each boat should be protected with antifouling paint because straggling of the boat reduces its speed. Nowadays there is a wide choice of protection paints and the purpose of their use is adjusted to the different types of water. After the year of exploitation of the boat, the bottom of the hull must be painted with a antifouling paint.

It is advised to conserve the hull at least once a year (covering the hull surface under the water line with a preservation paint). An epoxy coat is recommended for this purpose.

Remember that any excessive sanding before the antifouling paint attacks your gel coat and impairs its reliability.

Your boat may regain its shine as new if reglarly polished.

RIGGING AND SAILS

The main drive of the boat are triangular sails consisting of genoa and mainsail. Additionally, the boat may be equipped with two jibs and spinnaker. The sails are mounted on the mast made of duraluminium profile reinforced with wire ropes. The mast is situated on the deck over the pillar.

STANDING RIGGING

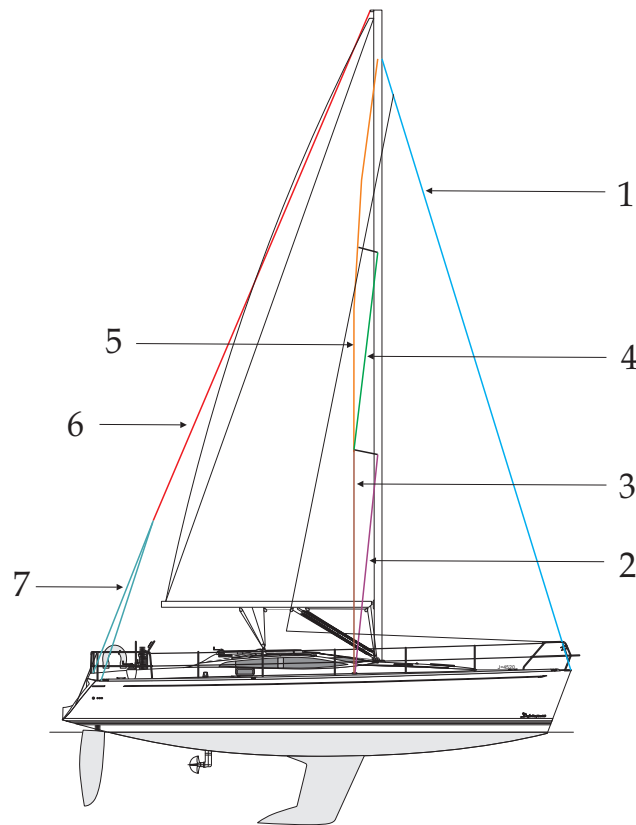

| | | |
|---|-----------------|--------|
| 1 | Forestay | Ø 7 mm |
| 2 | D1 | Ø 7 mm |
| 3 | V1 | Ø 7 mm |
| 4 | Spreader shroud | Ø 5 mm |
| 5 | Top mast shroud | Ø 7 mm |
| 6 | Backstay | Ø 6 mm |
| 7 | Bridle | Ø 6 mm |

MAST INSTALLATION

Before mast installation:

- protect the mast against possible damage during unloading;
- tie down the shrouds and all the rigging to the base of the mast.

ATTENTION!

Before you lift the mast, make sure that there is enough space and it is clear (no electric cables, etc.)



During mast installation:

- take all the necessary steps to avoid damaging the mast equipment;
- put the mast on the mast support;
- make sure that the base of the mast integrally bears on its base plate;
- lift the mast using a mast drop system;

After mast installation:

- install the standing rigging (check the tightening and position);
- check the tightening of the fastening pins on the rigging screws;
- mount the boom;
- mount the topping lift and tighten it until the boom is perpendicular to the mast;
- reconnect the electric cables;
- adjust the mast after a few trips.

MAINTENANCE OF THE MAST

Before each trip carefully inspect the mast from the top to the bottom. Periodically check the rigging tightening and the rest of the mast elements (you should check it for the first time after a few days of sailing in different types of weather). From time to time you should lubricate the rigging screws with graphite grease and inspect them for possible wear. Change any shroud or stay with severed wires.

DANGER !

In order to repair or inspect the mast during sailing, you can lift one of your crew member to the top of the mast. Remember not to use connected halyards for this purpose and not to do it in heavy weather conditions.



RUNNING RIGGING

1. Mainsheet traveler adjustment- \varnothing 8 mm
2. Mainsail furlex- \varnothing 10 mm
3. Spinnaker boom kicking strap- \varnothing 12 mm
4. Mainsail halyard- \varnothing 12 mm
5. Mainsail sheets - \varnothing 12 mm
6. Spinnaker boom halyard- \varnothing 10 mm
7. Spinnaker halyard - \varnothing 12 mm
8. Genoa halyard- \varnothing 12 mm
9. Fore sail sheets - \varnothing 14 mm
10. Spinnaker sheets- \varnothing 12 mm
11. Genoa furlex- \varnothing 10 mm

RUNNING RIGGING MAINTENANCE

- regularly lubricate the sheaves;
- change any distorted or dented sheaves;
- regularly check the jaw cleats condition;
- replace the ropes which are worn out;
- regularly clean the blocks (waste grease, corrosion);
- check the winches regularly.

WARNING!

Refer to the manufacturer's instruction to remove the winches and put them back. Improper refitting may result in accidents.



SAILS

1. Genoa - 29,00 m²- red colour
2. Mainsail - 32,00 m²- green colour
3. Spinnaker * - 60,00 m²- blue colour

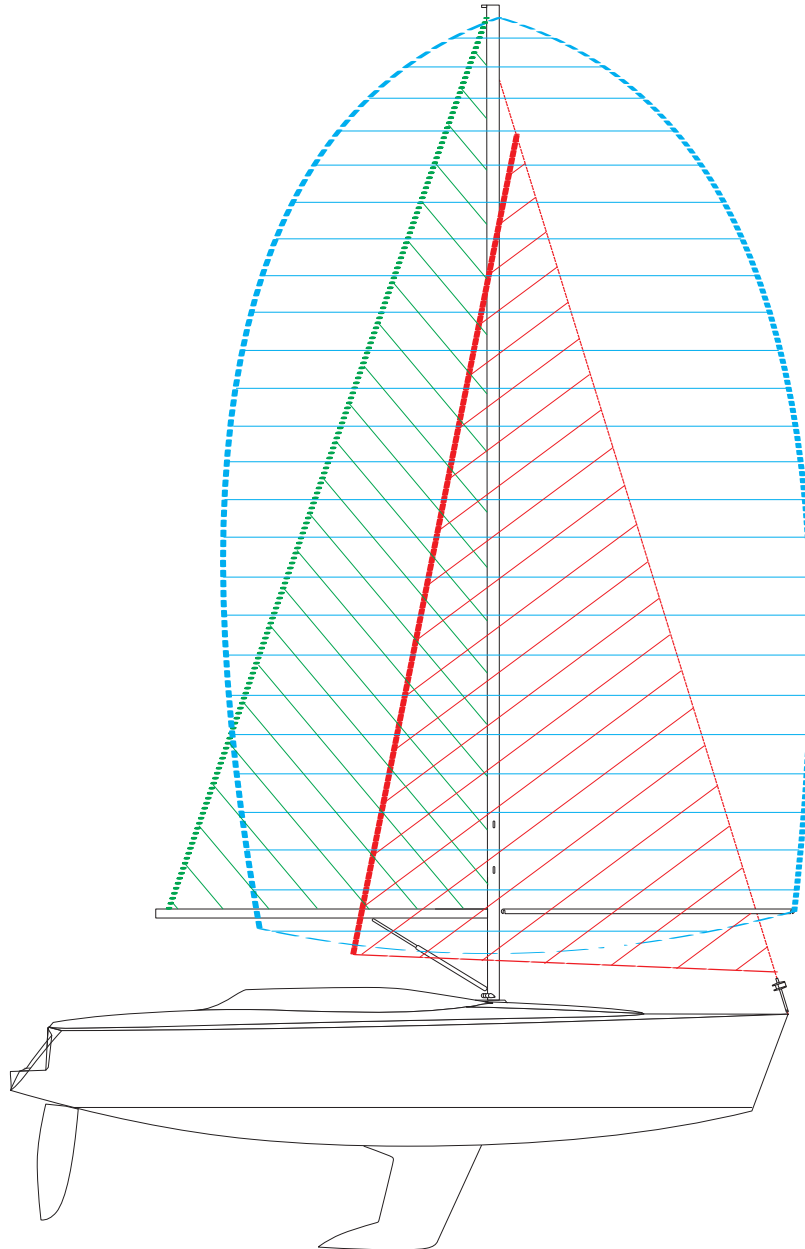

*-Additional option

ATTENTION !

Regularly check the condition of the sails

**ADVICE**

After the end of a sailing season leave your sails to a specialist to carry out accurate maintenance and repairs.

During the first trips trim the sails properly in order to reduce the harmful strains on them. napięcia na ich strukturze. In order to avoid tears and wear you should secure the elements with rough surface. Between the trips, slack away the halyards and the mainsail foot tuning line.

CLEANING AND MAINTENANCE

Rinse your sails from time to time with fresh water without any detergents and dry them quickly in order to avoid mildew. Avoid drying the sails on the mast because you can make the seams worn and the sails may be torn by the rigging. To remove grease stains use special substances for this purpose which you can buy in marine store.

SAIL STORAGE

Store the sails in a special bag that you received together with the sails. Remember that the sails must be dry in order to prevent mildew from apperaing.

PROTECTION

If the sails remain on the mast for about 24 hours protect them from UV rays with a cover placed on the leech and foot of the furled sails. UV rays are harmful to polyester and nylon.

RUNNING RIGGING FOR CLASSIC MAINSAIL

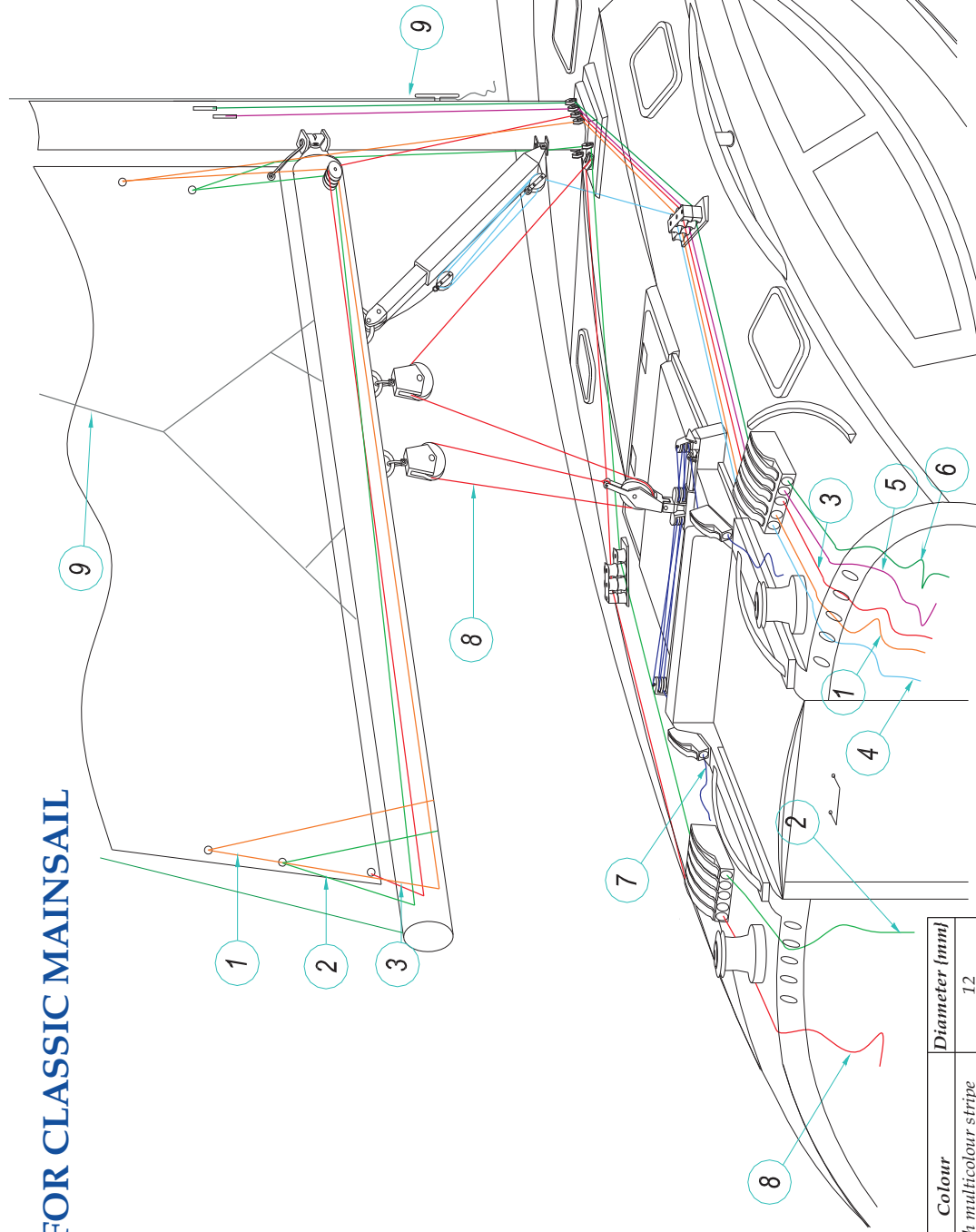

| Running rigging description | Colour | Diameter (mm) |
|-----------------------------|-------------------------------|---------------|
| 1 Reef 1 | white with multicolour stripe | 12 |
| 2 Reef 2 | white with multicolour stripe | 12 |
| 3 Mainsail foot tuning line | white with multicolour stripe | 14 |
| 4 Gas kicking strap halyard | red | 10 |
| 5 Mainsail halyard | white with blue-yellow stripe | 12 |
| 6 Topping lift | white with blue-yellow stripe | 10 |
| 7 Mainsail traveler halyard | white | 8 |
| 8 Mainsail sheets | red | 12 |
| 9 Lazy jack | white | 8 |

RUNNING RIGGING FOR FURLING MAINSAIL*

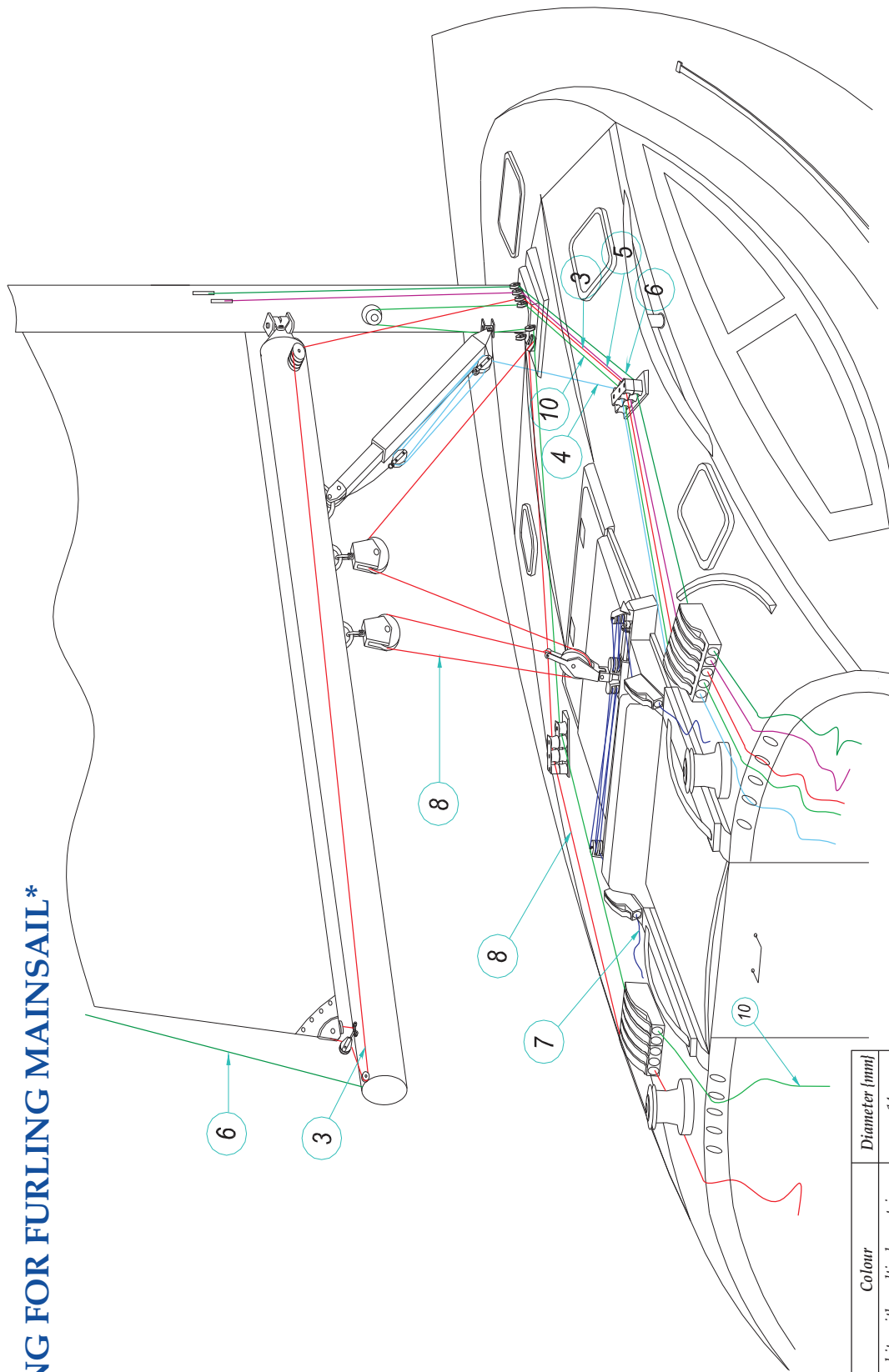

| Running rigging description | Colour | Diameter (mm) |
|------------------------------|-------------------------------|---------------|
| 3 Mainsail foot tuning line | white with multicolour stripe | 14 |
| 4 Gas kicking strap halyard | red | 10 |
| 5 Mainsail halyard | white with blue-yellow stripe | 12 |
| 6 Topping lift | White with blue-yellow stripe | 10 |
| 7 Mainsail traveler halyard | White | 8 |
| 8 Mainsail sheets | Red | 12 |
| 10 Mainsail furler halyard * | Green | 10 |

RUNNING RIGGING FOR GENOA

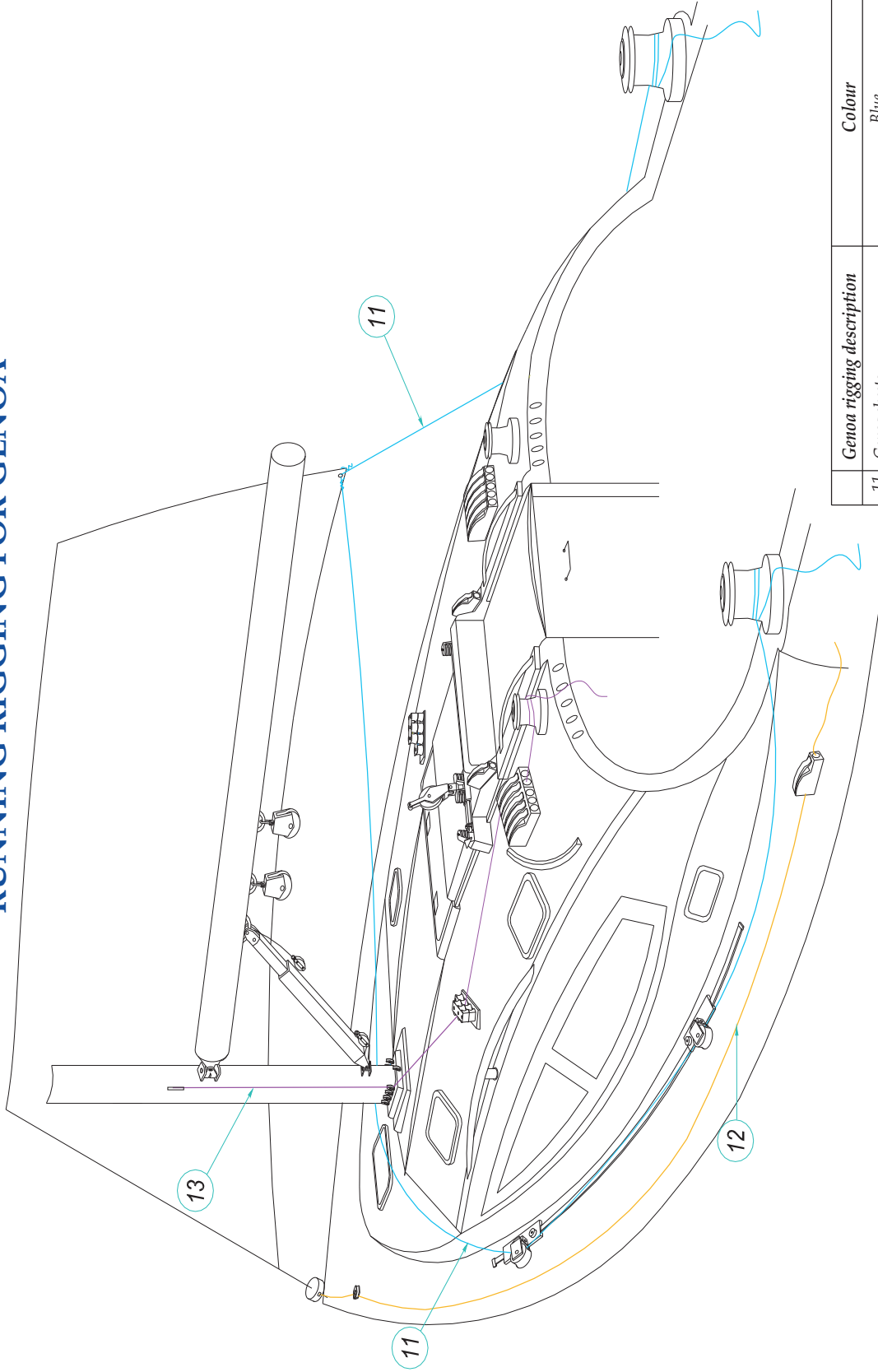

| Genoa rigging description | Colour | Diameter (mm) |
|---------------------------|-------------|---------------|
| 11 Genoa sheets | Blue | 14 |
| 12 Genoa furler halyard | White-black | 10 |
| 13 Genoa halyard | White-blue | 12 |

RUNNING RIGGING FOR SPINNAKER

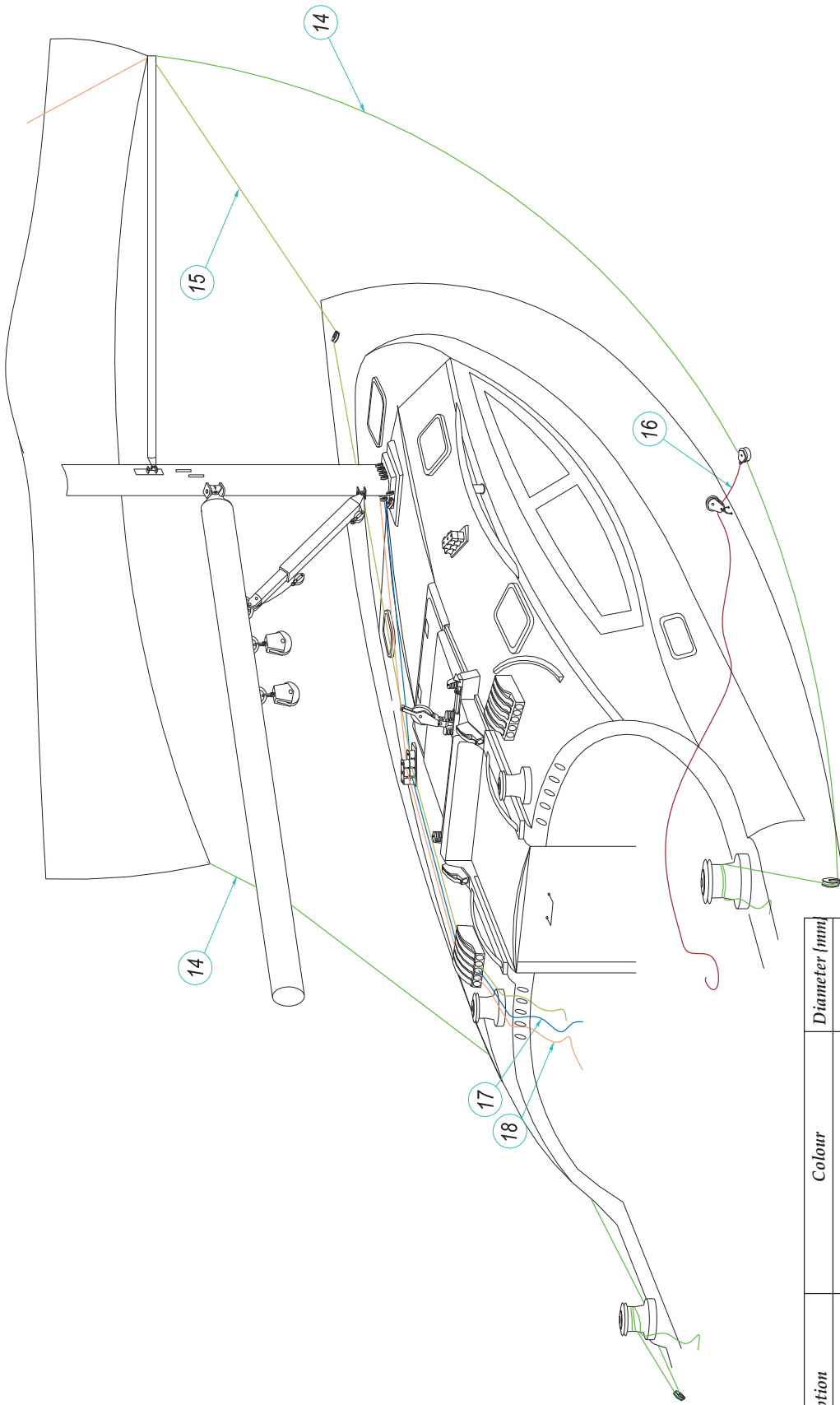

| Spinnaker rigging description | Colour | Diameter (mm) |
|---------------------------------|--------------|---------------|
| 14 Spinnaker sheets | green | 12 |
| 15 Spinnaker boom kicking strap | White-red | 12 |
| 16 Baberholer | blue | 10 |
| 17 Spinnaker hallyard | White-red | 12 |
| 18 Spinnaker boom hallyard | White-yellow | 10 |

CABINS

D- 33 2 CABINS

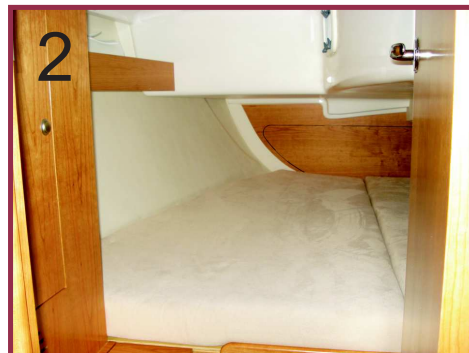
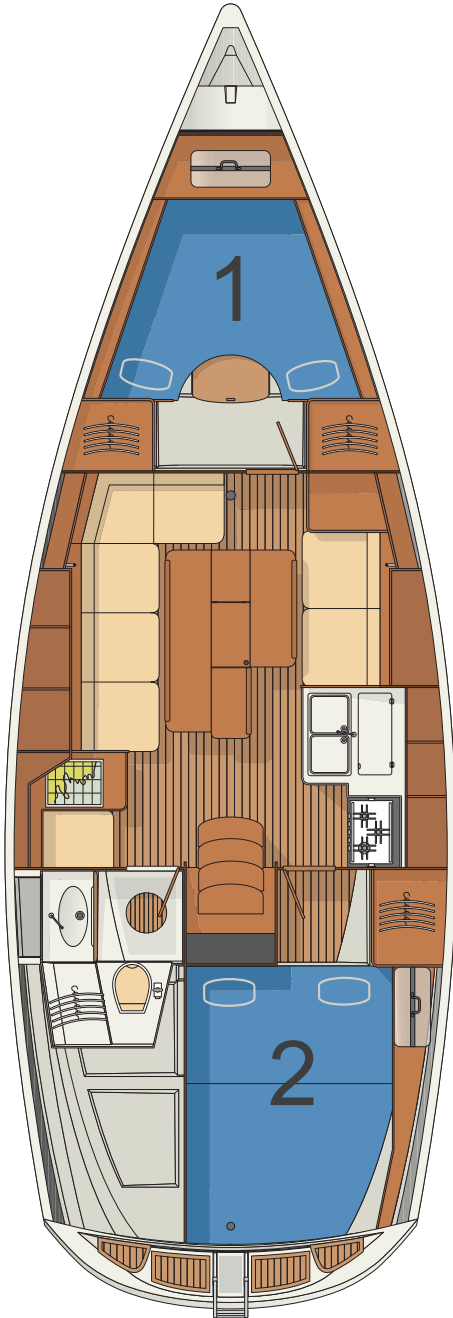

CABINS- blue colour

D- 33 3 CABINS

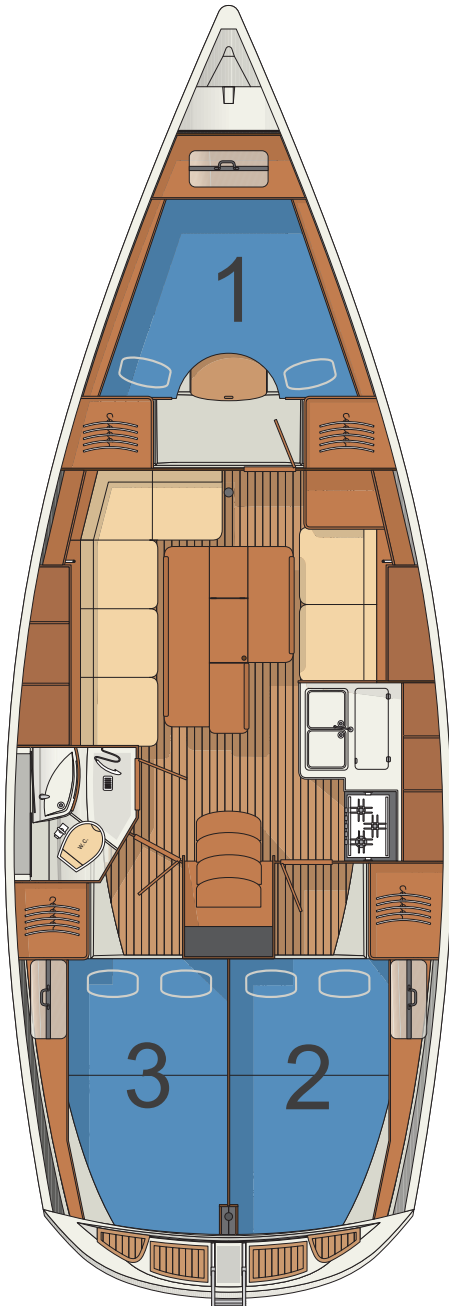

CABINS- blue colour

MAINTENANCE

INTERIOR

- Take the advantage of fine weather to take the settee and berth cushions out.
- Use blinds to protect the inside of the boat against UV rays.
- Be careful during vacuuming in order not to damage anything.

INSIDE VARNISH

- Rinse the inside varnish with fresh water mixed with spot remover and shampoo.
- It is advised to polish the inside varnish with shammy leather.

FABRICS (stain removal)

- Remove as much stain as you can with a knife blade.
- Dab with a clean rag.
- To remove the stain completely, use solvent on a clean rag. Never pour the solvent directly on the stain.
- Then rub with a clean and dry rag.
- Brush the fabric against the grain.
- Use the vacuum cleaner when the fabric is dry.

LEATHER

- Use a leather cream for ordinary care of leather fabrics.
- Do not use detergents.
- Do not use silicon based products.
- Clean with a sponge and water with soap.
- Remove the grease stains with appropriate products (e.g. talcum powder).

BILGE SYSTEM

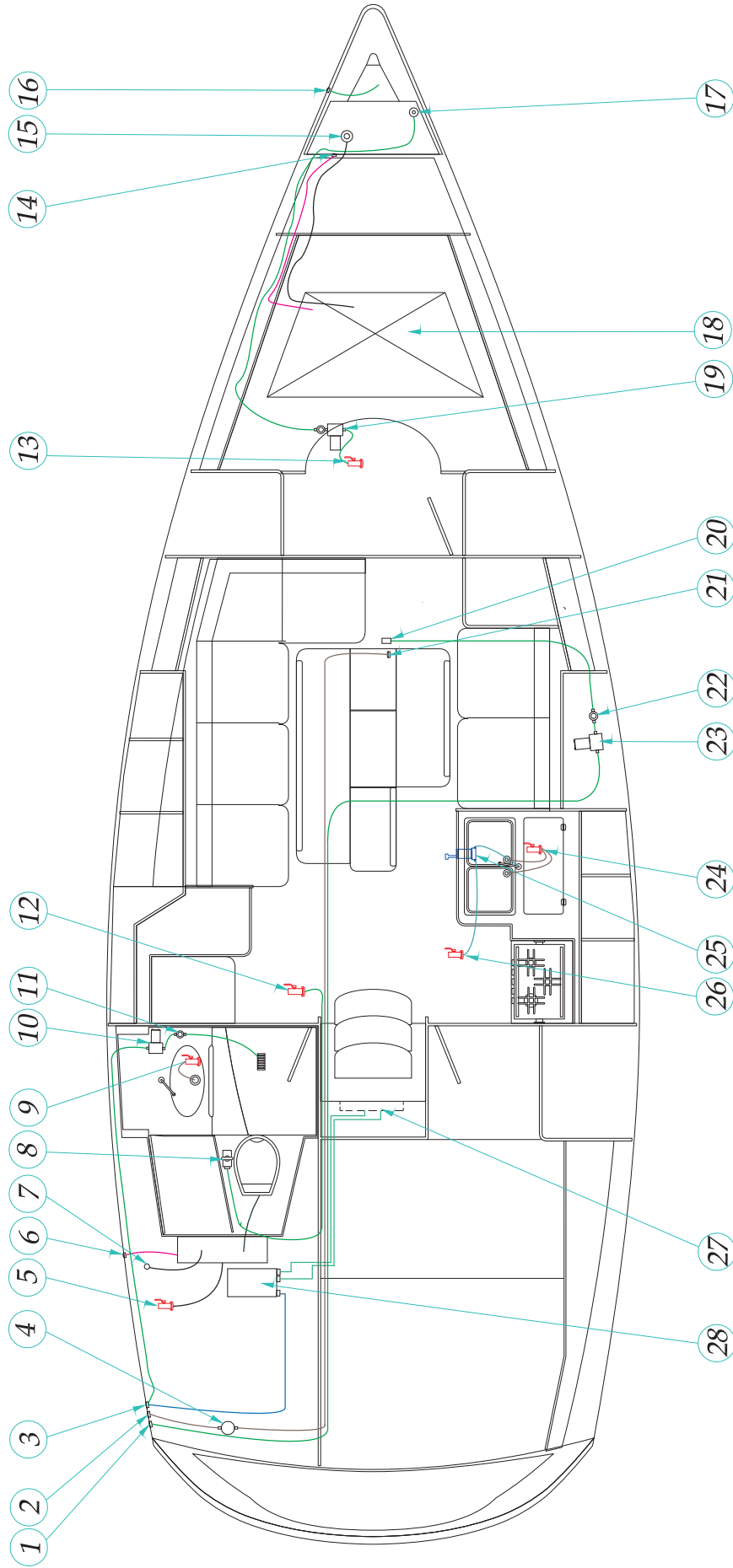

- Ø 10
- Ø 13
- Ø 16
- Ø 19
- Ø 25
- Ø 38

| Nr: | Bilge system scheme description |
|-----|--|
| 1 | Discharge of water from auto-manual bilge pump |
| 2 | Discharge of water from manual bilge pump |
| 3 | Discharge of water from the boiler and shower pump |
| 4 | Manual bilge pump |
| 5 | Waste water tank outlet valve |
| 6 | Waste water tank vent |
| 7 | Waste water tank intake |
| 8 | Toilet manual pump |
| 9 | Toilet sink outlet valve |
| 10 | Shower pump |
| 11 | Shower pump filter |
| 12 | Toilet water intake valve |
| 13 | Deck wash inlet valve* |
| 14 | Fresh water tank vent |
| 15 | Fresh water tank intlet |
| 16 | Discharge of water from anchor chamber |
| 17 | Connector* |
| 18 | Fresh water tank |
| 19 | Deck wash pump* |
| 20 | Auto-manual bilge pump suction pipe |
| 21 | Manual bilge pump suction pipe |
| 22 | Bilge pump filter |
| 23 | Auto-manual bilge pump |
| 24 | Kitchen sink outlet valve |
| 25 | Salt water foot pump* |
| 26 | Salt water inlet valve* |
| 27 | Engine |
| 28 | Boiler |

BILGE PUMP SYSTEM

In bilge pump system for D-29.2 there are two bilge pumps:

- auto-manual bilge pump (electric);
- manual bilge pump (manual).

AUTO-MANUAL BILGE PUMP

Pump model: JABSCO 37202-2 10A (120W).

Auto-manual bilge pump, as the name indicates, has two functions: automatic and manual. When you want to use the automatic pump you should turn on on the switchboard panel **bilge auto-manual** fuse, and then on the pump panel (photo 1) turn the switch to **auto** position. In order to use the manual option you should turn the switch on the pump panel to **manual** position.



1. Bilge pump panel



2. Auto-manual bilge pump



3. Bilge pump suction pipe and sensor

MANUAL BILGE PUMP



Manual bilge pump with the output of 50 l/min. Is located on cockpit starboard. Bilge suction pipe is located under the floor in the messroom. Remember to always have an easy access to the pump lever.

The distribution of particular elements of bilge pump system on the boat-refer to bilge system scheme on page 33.

OUTLET VALVES IN THE TOILET



Waste water tank discharge valve



Sink outlet valve



Opened valve



Closed valve

SANITARY APPLIANCES

TOILET

- Before using the toilet check if the water inlet valve is opened.
- In order to avoid clogging the toilet use absorbent paper only.
- Rinse the toilet regularly with fresh water.
- Close the valve after each use.

SINK AND SHOWER

- Close the valves and turn of the taps after each use.
- Remove the water from the shower cabin using the shower pump.

Regularly check the level of waste water in the tank using DCT/LM indicator.

The distribution of particular elements of sanitary appliances - refer to the bilge system scheme from page 33.

TOILET INSTALLATION SCHEME

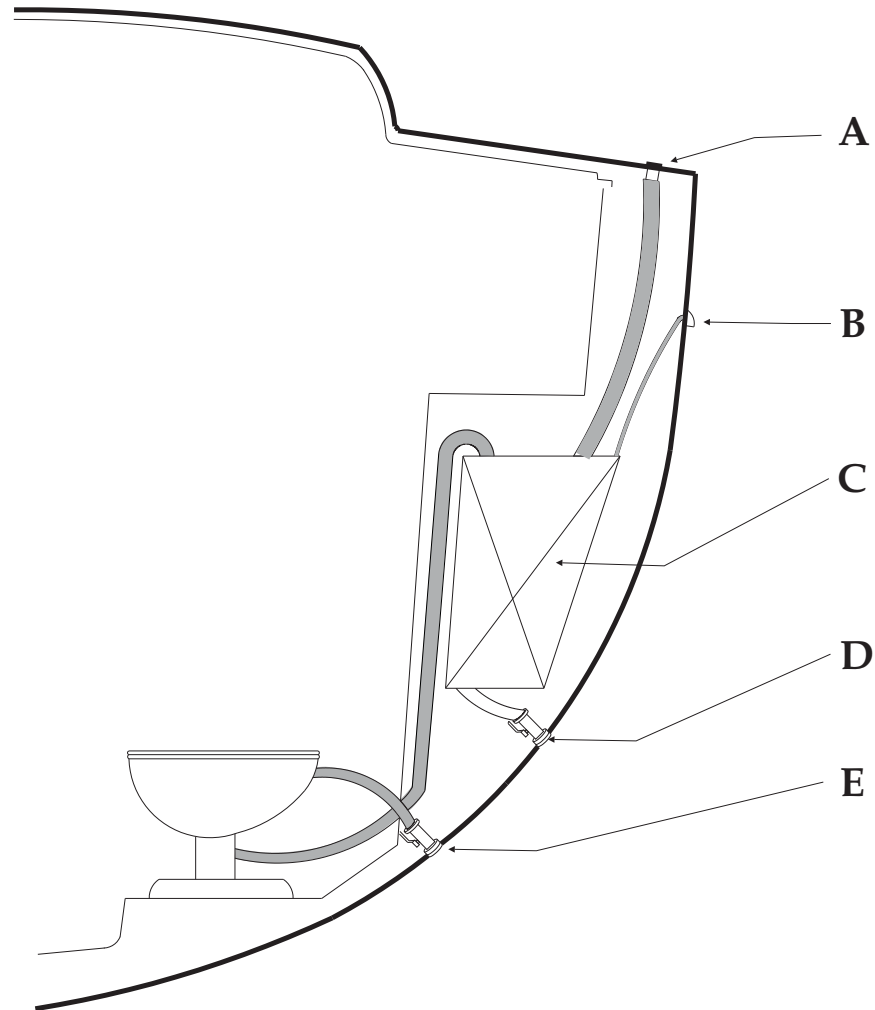

- A. Waste water tank outlet (use to empty the tank in a marina)**
- B. Tank vent hole**
- C. Waste water tank**
- D. Waste water draining valve (use to empty the tank in open sea)**
- E. Outboard water intake**

The distribution of particular elements of toilet installation - refer to the bilge system scheme from page 33.

FRESH WATER INSTALLATION SCHEME

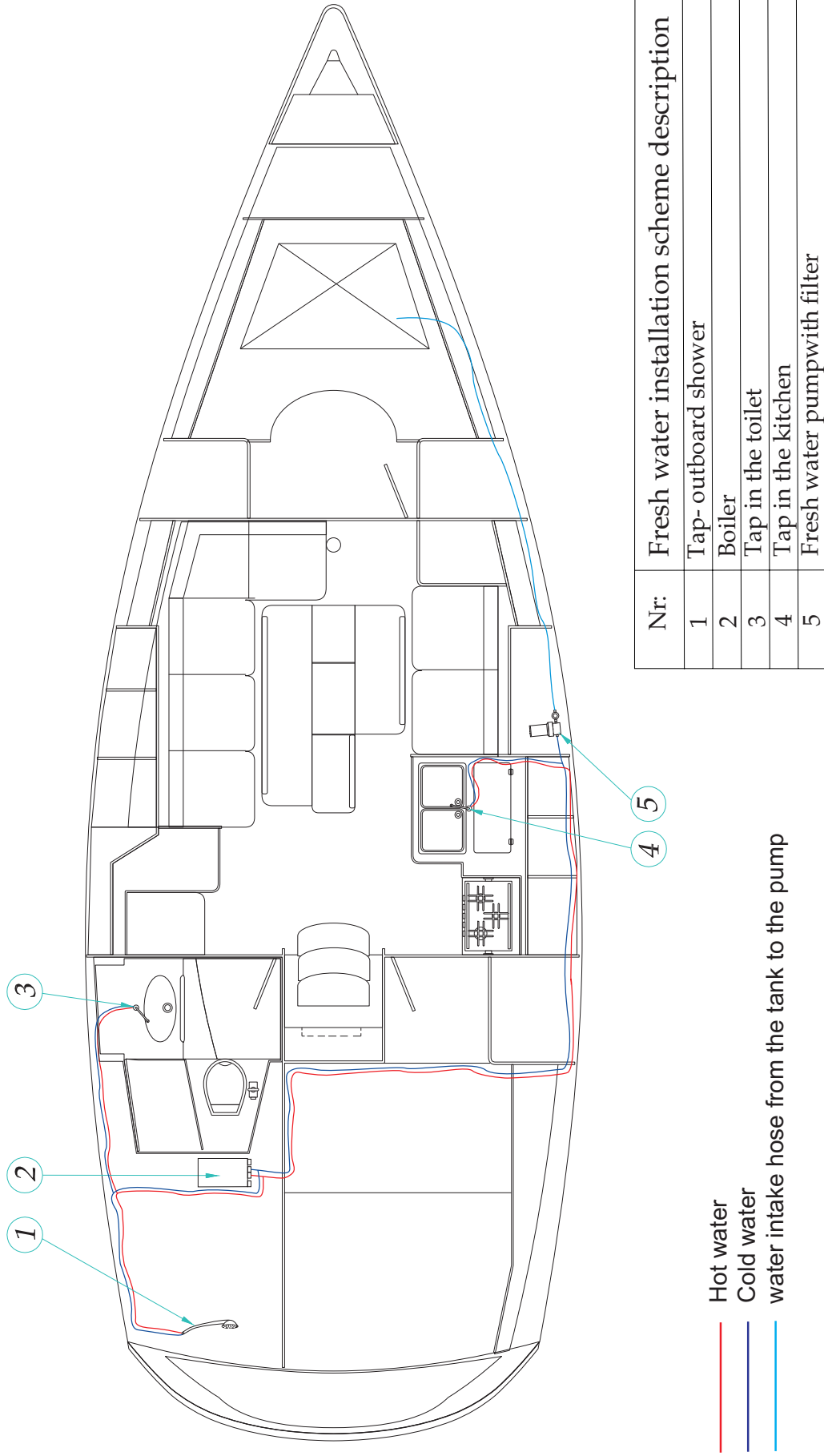

FRESH WATER TANK

- Fresh water tank is made of stainless steel and has the capacity of 215 litres
- Do not fill up the water and fuel tank at the same time.
- Regularly check the tightness of water tank inlet plug.

The water filler is located in the bow part under the anchor chamber cover



MAINTENANCE

- Pay attention to the quality of the water for filling up, Check if it is drinking water.
- Sterilize the tank periodically. Use only special products for this purpose, which you can buy at the Chemist's.
- If the boat has not been used for long, you should purify the tanks and pipes with acetic acid or white vinegar.
- Do not use chlorine-based liquids because they may weaken the material that the tanks are made of (stainless steel)

Advice

- Do not use the water system appliances when the valve is closed or the tank is empty.
- Regularly check the water filter condition.
- Close the valves when the tank is completely empty.

SEA WATER INTAKE AND DISCHARGE INSTALLATION IN THE MESS *

1. Sink outlet valve.

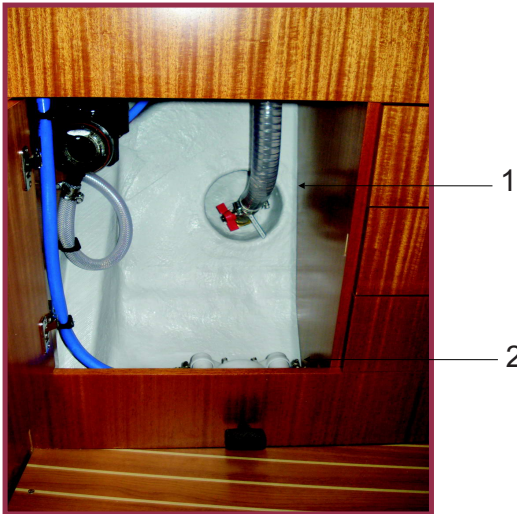

Opened valve

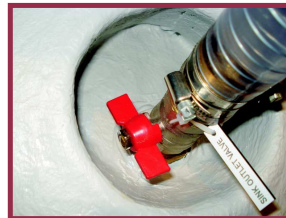

Closed valve

2. Sea water foot pump.



*-Additional option

3. Sea water intake valve placement.

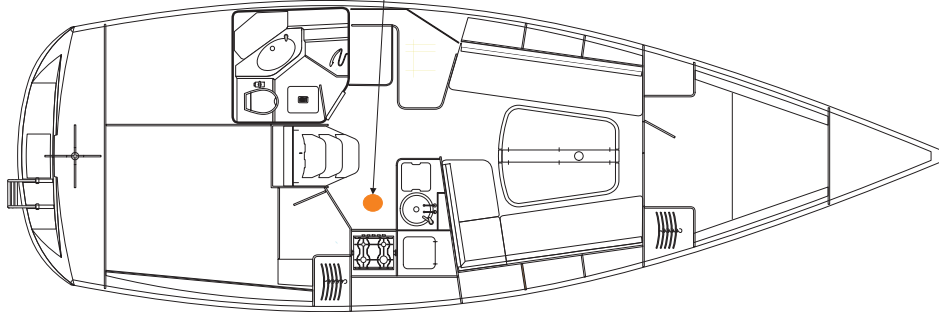
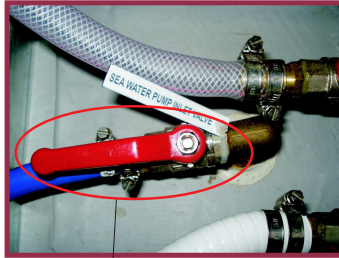

The distribution of particular elements of sea water intake and discharge installation-
- refer to the bilge system scheme on page 33.

DECK SHOWER*



In order to use the deck shower you should turn on **shower pump** securing on the switchboard panel and then turn on the pump with a switch (photo 1) located in the bow locker (anchor chamber). Just next to the switch there is a connector pipe (photo 2) to which you should connect a wash-deck hose. Before turning the pump on remember to check if the water intake valve is opened.



The distribution of particular elements of deck shower is shown on the bilge system scheme on page 33.

*-Additional option

GAS INSTALLATION SCHEME

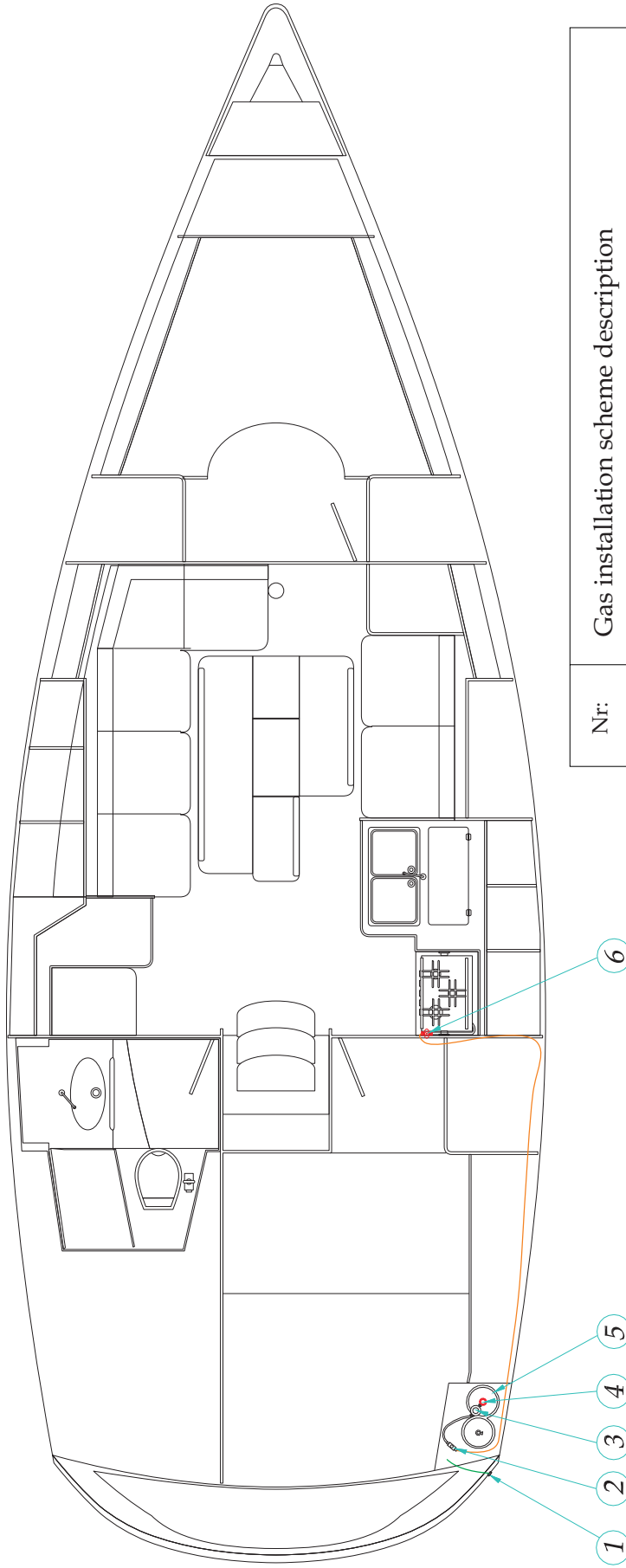

| Nr: | Gas installation scheme description |
|-----|-------------------------------------|
| 1 | Gas outlet |
| 2 | Gas tester |
| 3 | Reducer |
| 4 | Valve |
| 5 | Gas cylinder |
| 6 | Valve on gas installation |

— Gas copper pipe

GAS VALVE

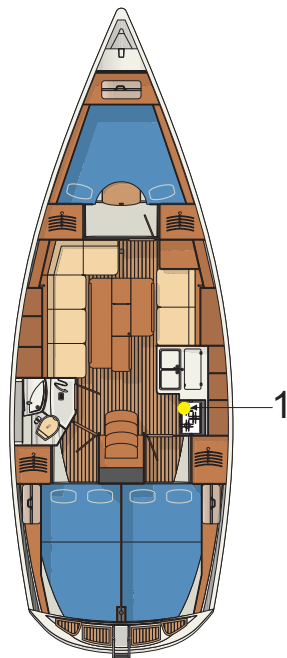

1. Installation valve under the cooker

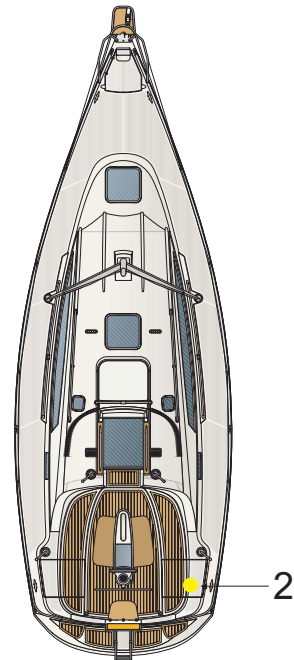

2. Gas cylinder valve

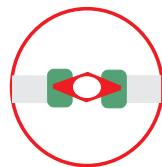
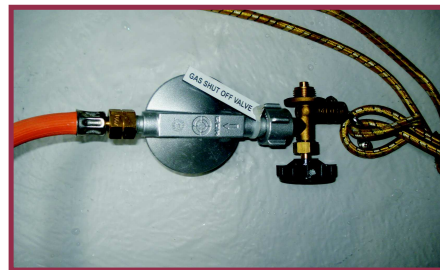

Opened valve

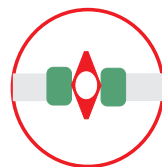

Closed valve

The distribution of particular elements of gas system - refer to gas installation scheme on page 43.

GAS CYLINDER LOCKER

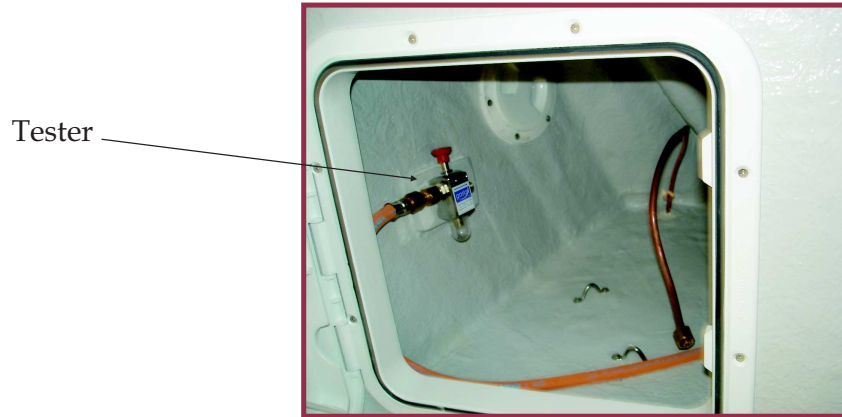

TESTER

Tester is used to check the hermeticity of gas installation.

In order to check the hermeticity you should:

1. Open all the gas valves (with connected gas cylinder).
2. Push the red button on the tester and hold for several seconds (there should be glicole in the small tank).

If the air bubbles does not appear in the tank at that time, this means that the installation is hermetic.

GAS SYSTEM SAFETY INSTRUCTION

If you do not use gas appliance, close the gas valves. When changing the cylinder the valves should also be closed.

In case of a gas leak, close the cylinder valve and repair the system before you use it again. The repair must be carried out by a qualified person.

Never obstruct the fast access to the components of gas system.

The valve of empty gas cylinders should always be closed and disconnected. Keep the protection, lids, covers and taps in their places. Store the spare cylinders on the deck or in a locker with a ventilation to the open air.

Do not the gas cylinder storage place to store any other equipment.

Regularly check (at least once a year) the rubber hoses and replace them if needed.

Do not use the cooker when there is possibility of big rolling angle or the constant inclination angles (if the unit is not fitted with a cooker with cardan hanging).

ATTENTION !

- Do not use liquids containing ammonia;
- Do not use a flame to detect leaks;
- Do not smoke, do not use a naked flame when you change the gas cylinder.



WARNING !

The appliances that burn gas in naked fire use oxygen of the cabin and release combustible gases to the inside of the unit. Ventilate the cabin when using appliances. When using appliances open the air vents.

Do not use the stove or the oven as heaters.



WARNING !

Never use an appliance unattended when it is working.



STATIONARY HEATING INSTALLATION SCHEME

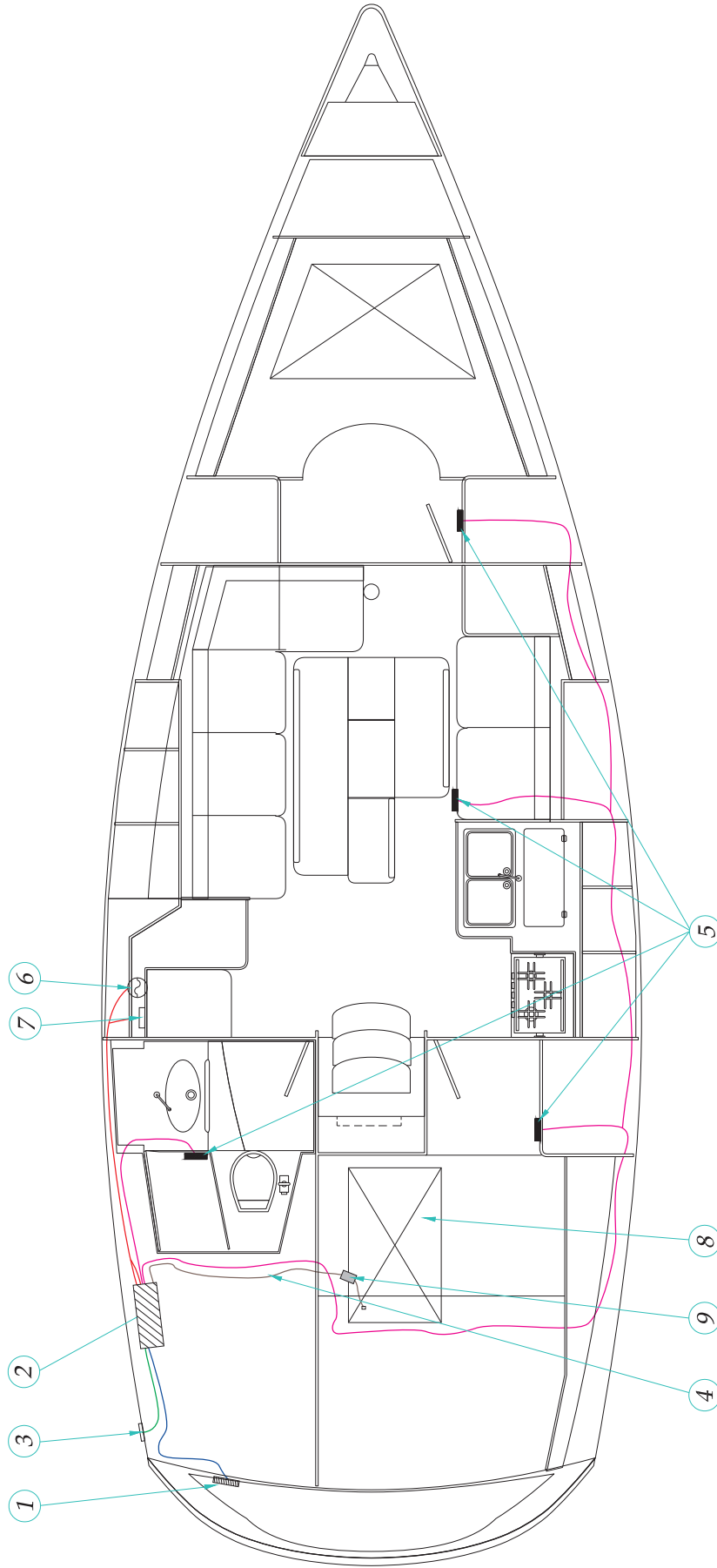



STATIONARY HEATING SYSTEM (WEBASTO)*

| <i>nr.</i> | Webasto heating system description |
|------------|--|
| 1 | Air intake |
| 2 | Webasto |
| 3 | Combustion gas outlet |
| 4 | Webasto fuel tube |
| 5 | Hot or cold air outlets |
| 6 | Webasto power supply fuse (in the switchboard) |
| 7 | Control panel and webasto temperature sensor |
| 8 | Fuel tank |
| 9 | Fuel pump |

1. Webasto control device.

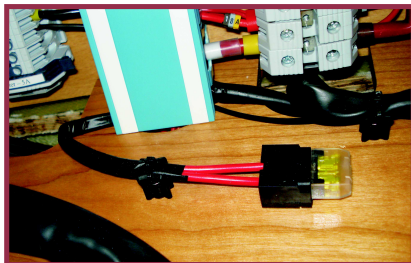

2. Stationary heating system power supply fuse located in switchboard locker.

*-Additional option

ENGINE

D-33, depending on the customer needs, may be equipped with one of the two types of engine:

1. Stationary engine S-drive;
2. Stationary propeller shaft engine;

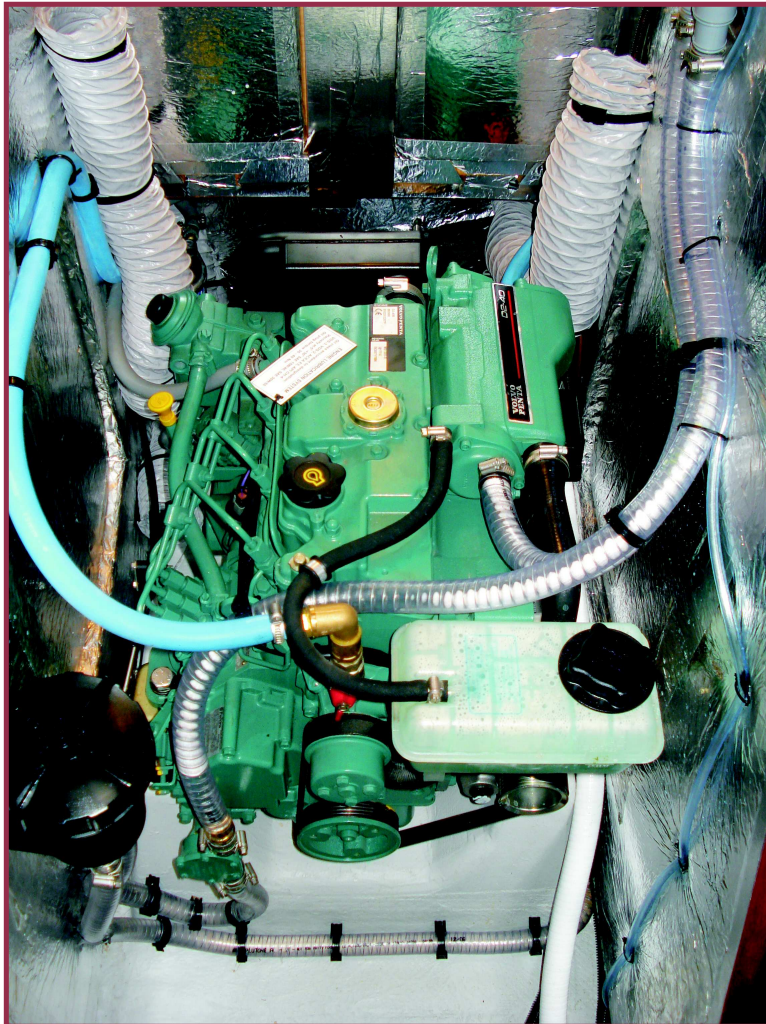

ATTENTION !

Read the engine manual before starting it for the first time.

ENGINE INSTALLATION SCHEME

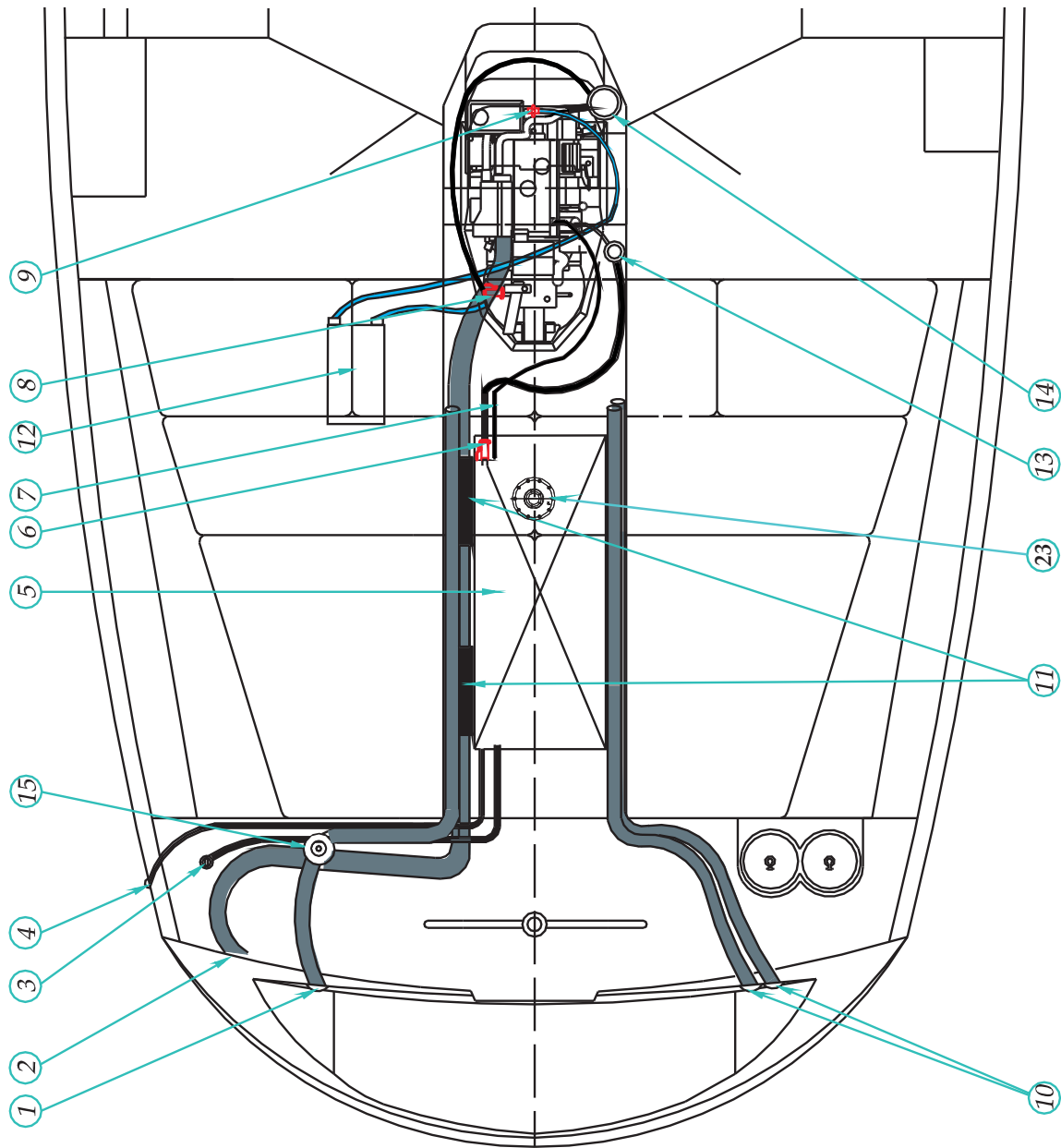

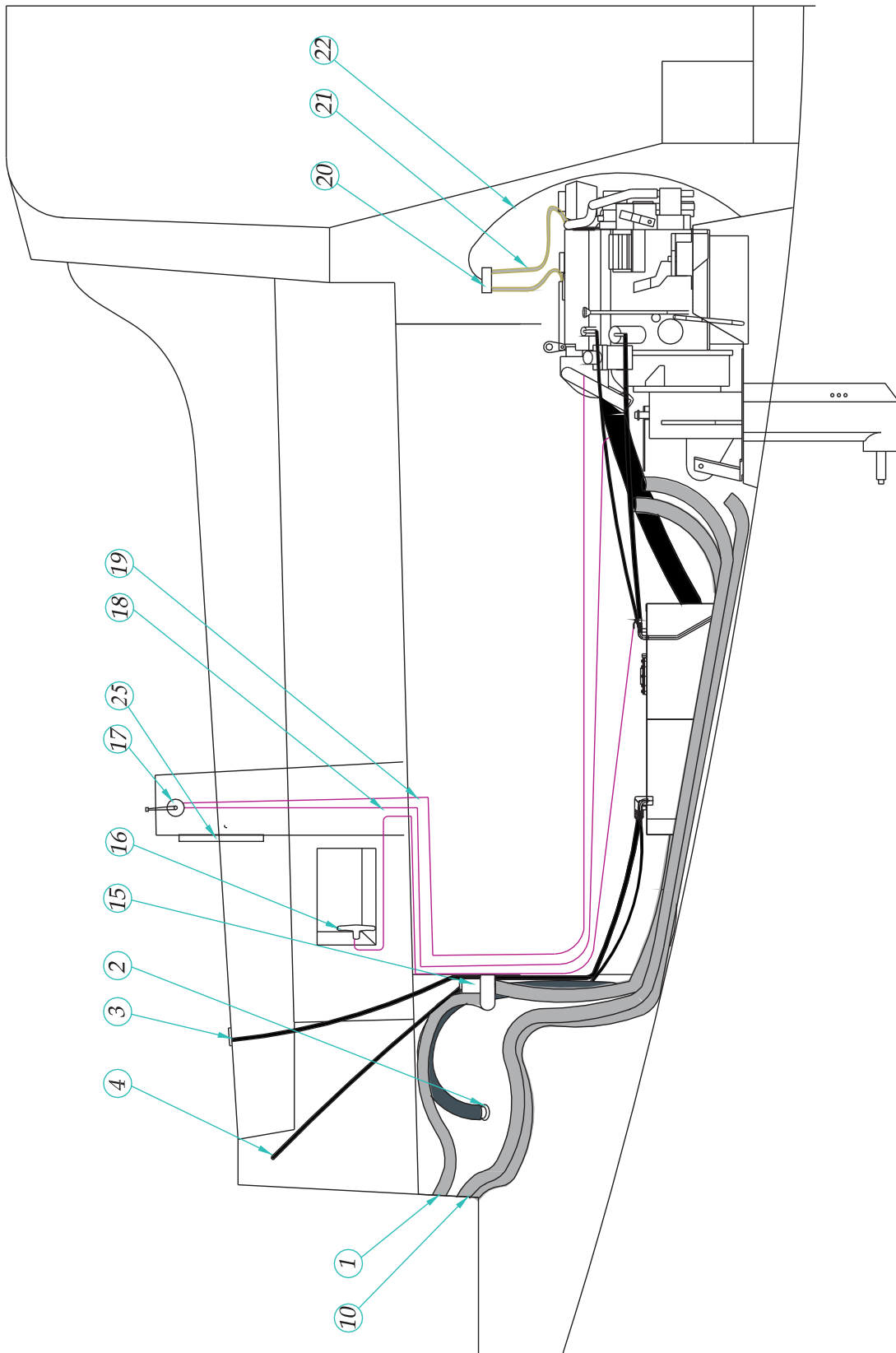

| <i>nr:</i> | Engine installation scheme description |
|------------|--|
| <i>1</i> | Engine compartment ventilation outlet |
| <i>2</i> | Engine combustion and water outlet |
| <i>3</i> | Fuel tank inlet |
| <i>4</i> | Tank vent hole |
| <i>5</i> | Fuel tank |
| <i>6</i> | Closing valve of the fuel system |
| <i>7</i> | Fuel excess pipe |
| <i>8</i> | Sea cooling water engine inlet valve |
| <i>9</i> | Boiler water circuit valve |
| <i>10</i> | Engine compartment ventilation inlet |
| <i>11</i> | Silencer |
| <i>12</i> | Water heater |
| <i>13</i> | Fuel filter |
| <i>14</i> | Sea water filter |
| <i>15</i> | Engine compartment fan |
| <i>16</i> | Emergency fuel cut off |
| <i>17</i> | Shifter |
| <i>18</i> | Revolution level string |
| <i>19</i> | Gear level string |
| <i>20</i> | Engine cooling system vent hole |
| <i>21</i> | Engine cooling system water vent inlet |
| <i>22</i> | Engine vent water outlet to bilge |
| <i>23</i> | Tank check hole and fuel sensor |
| <i>24</i> | Level tank of cooling liquid |
| <i>25</i> | Engine control panel |

ACCESS TO THE ENGINE

The engine is installed under the stairs. The stairs have been designed to enable the access to the engine after their deinstallation. Additionally in stern cabins there is back and side control hatch. After unmounting of all the hatches and the stairs you will get full access to the engine.

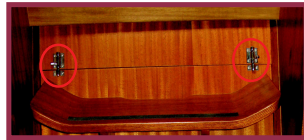

The stairs are secured with two locks

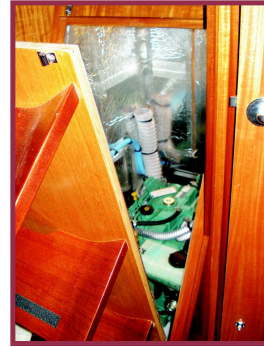

The stairs



Side hatch

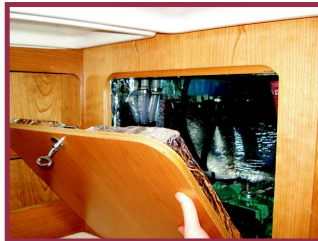

Back hatch



The control hatches open with a key.

BE CAREFUL !

Stop the engine before you open any of the hatches

When you need to inspect the engine while it is running you should:

- do not get close to wedge belts and other moving parts;
- be extremely careful if you wear loose clothes, long hair, jewelry;
- wear protection clothes (e.g. Gloves).



COOLING THE ENGINE WITH SEA WATER

In case of S-drive engine sea water is taken through the wholes placed on the gearbox (photo 1.1), whereas in case of propeller shaft engine goes through the whole in the hull of the boat (photo 1.2). Then the water goes through the valve (photo 2) and is directed to water filter (photo 3). From the filter it goes to water pump (integrated with the engine), and from there going through the vent hole (photo 4) the water finally gets to the cooling system inside the engine.



1.1. S-drive engine sea water inlets..



1.2. Propeller shaft engine water inlet hole with valve.

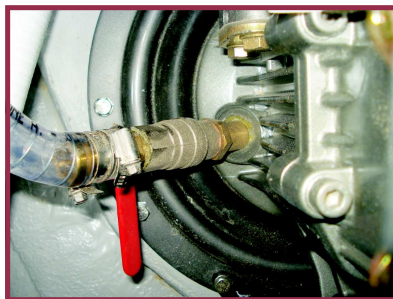

2. S- drive sea water inlet valve.



4. Vent hole



3. Water filter

USE OF ENGINE

TECHNICAL CONTROL BEFORE STARTING THE ENGINE:

- check oil levels;
- check cooling liquid level;
- open the fuel valve;
- turn on the power;
- check if the warning systems work;
- start the engine;
- check if the control instruments show the right values;
- check if there are any leaks on the engine or any of its parts;
- check the control instrument values;
- check if the engine achieves the nominal revolve speed.

ATTENTION !

Never turn off the power when the engine is running.



MAINTENANCE

ATTENTION !

All the information concerning the maintenance are presented in the engine manual.



OWNER'S DUTY

All the activities concerning maintenance such as oil and filters change should be noted. The recordings concerning maintenance are necessary to describe the warranty cover and should be handed to next owners of the boat.

FUEL TANK

REFUELLING

When refuelling the fuel try not to spill the fuel over the deck because it may cause the permanent decolorizations on the deck structure. In order to avoid that cover the area around the filler with a rag (piece of clothing). Doing that you will prevent the fuel from getting to the water, which is very important for environment protection.

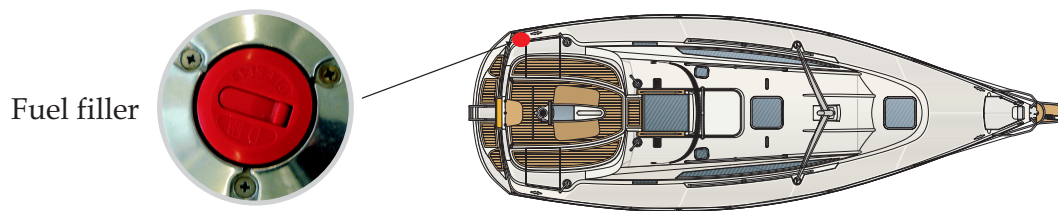

DANGER !

Do not fill the fuel when the engine is running!



MAINTENANCE

ADVICE

- Regularly check the tightness of the fuel filler to prevent the water from getting to the fuel tank.
- Do not cut off the fuel inlet to the engine when it is not used (only in the case when the boat is not used for a long time).
- After the end of sailing season clean the tank to get rid of dirt, deposit and the rest of the fuel.
- Do not clean the fuel tank with chlorine based liquids because it may badly affect the stainless steel, which the tank is made of.
- At least once a year conduct a detailed inspection of fuel system (tubes, valves).

ANTICORROSION PROTECTION

One of the main problems which boat owners face is electrochemical corrosion. There are countries where there are many motor and sailing boats docking in marinas at the same time using the shore power. The result of this may be a giant link. Among the factors which helps in development of corrosion process there are wandering currents from DC (12V) i AC (230V) installations and the fact that not all installations on the boats or in marinas work properly.

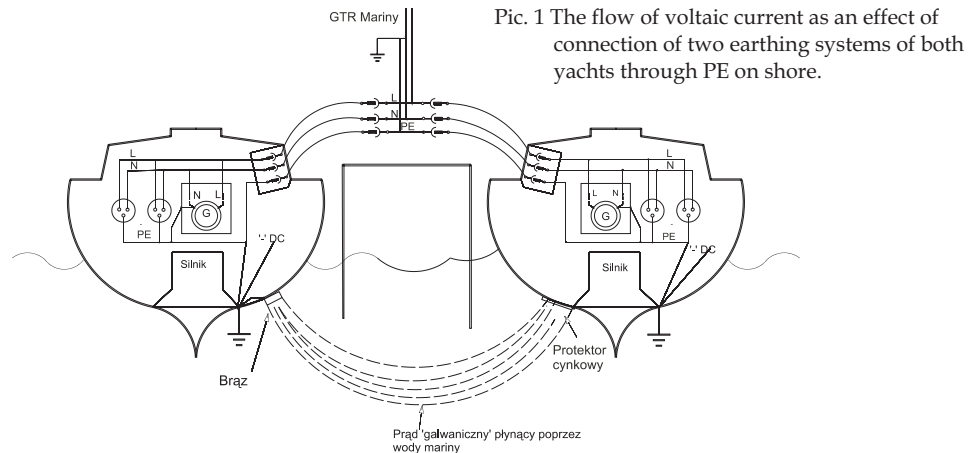

Pic. 1 The flow of voltaic current as an effect of connection of two earthing systems of both yachts through PE on shore.

It may be claimed that even properly installed and not modified simple 115/230 V AC installation after connection to shore power supply becomes an invitation for complicated corrosion processes which may be harmful to the boat. Finding a solution preventing the corrosion process and at the same time not reducing the effectiveness of anti electric shock crew protection is a real challenge.

The simplest solution which is practiced on some boats is disconnection of the PE cable (protection cable) from the earthing DC system. Doing that you cut off the connection of one element of the link with earthing PE cable on the shore, and the way for voltaic current cut off as well. After mooring to the quay and connecting to the shore power, the protection cable of the boat installation is connected to its equivalent on the shore and provides effective anti electric shock protection.

The rules of the biggest sailing tycoon, the USA, demand the PE cable to be connected to the main earthing DC installation minus pole (see pic.1 p. 108). In Europe, according to the current standards for boats concerning the low voltage electric installations (PN-EN ISO 10133) and alternating current (PN-EN ISO 10297), this is not necessary. It is enough to install a differential circuit breaker or separating transformer in the main AC installation circuit. Then, AC and DC installation do not have to be connected to the earthing system together. The PRS rules concerning the classification and building of yachts and motor boats in the chapter describing the requirements for installations and electric appliances of higher than safe voltage, say at the same time about the necessity of permanent connection of each metal elements (which may be under voltage) to earthing system. In case of commonly used on yachts and boats the energy division system TN-S, it is realized by the means of PE cable which is connected to each power socket.

We do not need to say how important is efficient cathode protection to maintain a good technical condition of propeller. Regular control of protectors (anode) is necessary before the start of sailing season and in the middle of it. It is also advised to check the efficiency of cathode protection by doing electric measurements (refer to control processes below). In case when the volume of protectors is reduced by half, they should be replaced with new ones. If the consumption is not significant, you can leave the same protectors for the next season. In order to get more detailed information concerning the replacement of the anode you should refer to manual which is attached to the engine.

ATTENTION !

On salt waters you should use zinc anodes and on fresh waters you should use magnesium anodes.



ANTI CORROSION SECURINGS CONTROL PROCESSES:

- check if there is no electric passage in S-drive engine, this means: with 12V master switches turned off touch the engine column with one tester pin and the gearbox with the second pin (photo 1). If the tester shows any value (different from the the one on the photo) this means that there is electric passage between the column and the gearbox. This problem should be immediately reported to the dealer or the engine manufacturer.



the second pin (photo 1). If the tester shows any value (different from the the one on the photo) this means that there is electric passage between the column and the gearbox. This problem should be immediately reported to the dealer or the engine manufacturer.



In both situations the switch of the tester should be positioned as presented on the photo (0- 200).

- check the galvanic insulator which is installed in the right stern locker (photo 2), in 115/230V circuit protection cable between the power dock and differential circuit breaker. If the tester shows the value as on the photo, this means that the insulator works properly. In case when the result is different, this means that the galvanic insulator does not work properly.

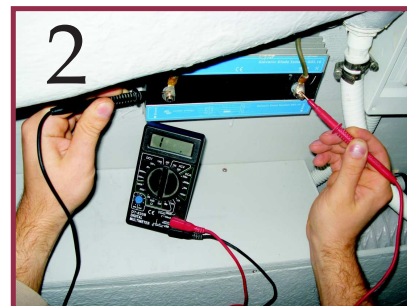

FIGHT AGAINST FIRE

What should you do in case of a fire in the engine compartment:

- Stop the engine.
- Switch off power and stop fuel supply.
- Use the extinguisher to fight the fire.
- Wait a moment because there is a risk of starting another fire.
- Start the repair if it is possible.

In case when you cannot stop the engine with a control panel, you should use the emergency fuel cut off (pic. 2).

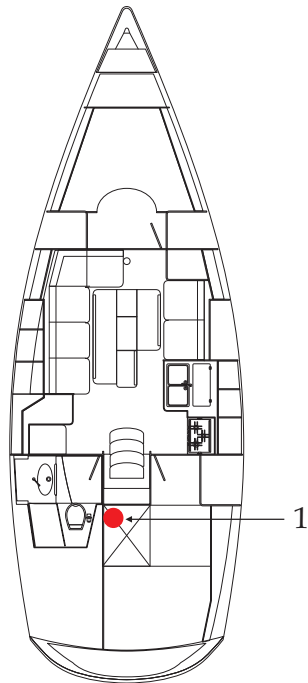

1. The fuel cut off valve

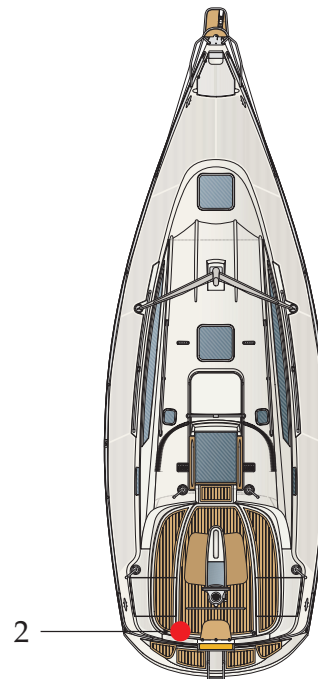



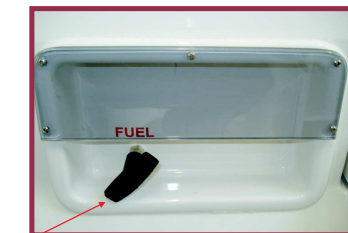



























2. Emergency fuel cut off handle



A detailed scheme and description of engine installation is shown on pages: 50, 51.

ELECTRIC SYSTEM

RECEIVERS DESCRIPTION

| | |
|---|------------------------------|
|  | Master switch |
|  | Cabin lamp |
|  | Red navigation lamp |
|  | Green navigation lamp |
|  | Pump engine |
|  | 12V socket |
|  | Automatic circuit breaker |
|  | Switch |
|  | Distribution bus |
|  | Radio stereo CD |
|  | Speaker |
|  | 230V socket |
|  | Differential circuit breaker |
|  | Charger |
|  | Boiler |
|  | Aft navigation lamp |
|  | Fan |
|  | Fuse |
|  | Shunt |
|  | Windlass electric engine |
|  | Thruster electric engine |
|  | Transmitter |
|  | Battery |
|  | Fridge |
|  | Antenna |
|  | Sensor |
|  | VHF radio |
|  | Switchboard |
|  | Webasto |
|  | Additional option |

CABLES DESCRIPTION

| | |
|------------------|------------------|
| r- | Red |
| n- | Black |
| b- | Blue |
| j/v- | Green-Yellow |
| m...- | Brown |
| r35 ² | — Cable diameter |
| _____ | — Cable colour |

SWITCHBOARD PANEL D-33

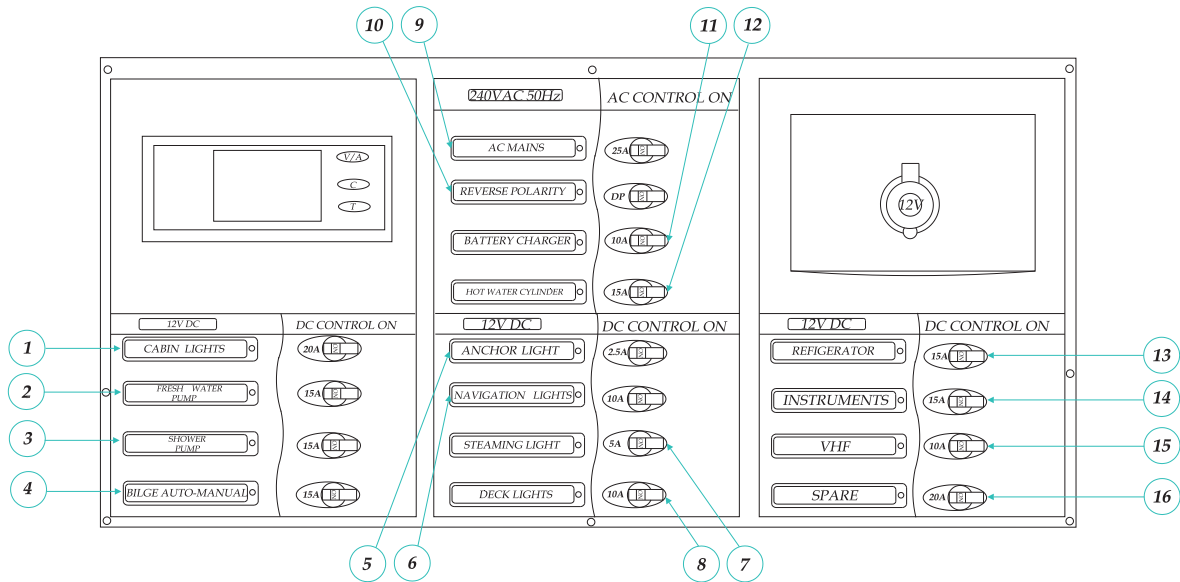

| Switchboard description | | |
|-------------------------|------------------------|------|
| 1 | Cabin lights fuse | 20A |
| 2 | Fresh water pump fuse | 15A |
| 3 | Shower pump fuse | 15A |
| 4 | Bilge auto-manual fuse | 15A |
| 5 | Anchor light fuse | 2.5A |
| 6 | Navigation lights fuse | 10A |
| 7 | Steaming light fuse | 5A |
| 8 | Deck light fuse | 10A |
| 9 | 230V instalation fuse | 25A |
| 10 | Reverse polarity lamp | |
| 11 | Battery charger fuse | 10A |
| 12 | Boiler fuse | 15A |
| 13 | Fridges fuse | 15A |
| 14 | Instruments fuse | 15A |
| 15 | Radio VFH fuse | 10A |
| 16 | Free | 20A |

| | Electric installation scheme description | |
|----------------|--|------|
| A | Navigation light fuse | 10A |
| 1A | Red navigation lamp | 25W |
| 1B | Green navigation lamp | 25W |
| 1C | Stern navigation lamp | 10W |
| 28B | Compass Olimpic 135 | 10W |
| B | Top lamp fuse | 5A |
| 6 | Top lamp | 10W |
| C | Running engine lamp fuse | 5A |
| 5 | Running engine lamp | 25W |
| D | Deck light fuse | 10A |
| 43 | Deck lamp | 35W |
| E | Deck wash down pump and shower pump fuse | 10A |
| 12 | Shower Jabsco 37202-2 pump | 120W |
| 12C | Johnson pump WPS 5.0 | 150W |
| F | Windlass pilot fuse | 5A |
| 20 | Windlass pilot | |
| 20A,20B | The windlass chain counter (additional option) | |
| G | Electric toilet pump fuse | 20A |
| 15 | Electric toilet pump Jabsco | 200W |
| 15A | Electric toilet pump Jabsco | 120W |
| H | Fresh water pump fuse | 15A |
| 10 | Fresh water pump Johnson WPS 5.0 | 150W |
| I | Fridge fuse | 15A |
| 17 | Messroom fridge | 7,5A |
| 17A | The fridge TC-07 in cockpit | 36W |
| J | Fan fuse | 5A |
| 53 | Fan | 4.3A |
| K | 12V socket fuse | 15A |
| 16 | Socket 12V | |
| L | Navigation instrument fuse | 15A |
| 80 | Smart pilot S1 system | 6W |
| 80A | C-80 | 10W |
| M | VHF fuse | 10A |
| 86 | Ray54E Marine VHF radio | 2W |
| N | Cabin light fuse | 20A |
| 13I | Cabin lamp | 20W |
| 13I1 | Cabin lamp | 20W |
| 13I2 | Cabin lamp | 20W |
| 13I3 | Neon lamp | 8W |
| 13K | Cabin lamp | 20W |
| 13K1 | Cabin lamp | 20W |
| 13K2 | Cabin lamp | 20W |

| | | |
|------------|---|--------|
| 13A | Cabin lamp | 10W |
| 13D | Cabin lamp | 10W |
| 13E | Cabin lamp | 10W |
| 13F | Cabin lamp | 10W |
| 13G | Cabin lamp | 10W |
| 13G | Cabin lamp | 10W |
| 13H | Cabin lamp | 10W |
| O | Stereo radio fuse | 10A |
| 88 | Radio stereo CD | 4x50W |
| P | Electric cooker fuse (option) | 10A |
| 82 | Electric cooker (option) | |
| R | Auto-manual bilge pump fuse | |
| 7 | Bilge pump floating switch | |
| 30A | Auto-manual bilge pump | 120W |
| S | Webasto fuse | 20A |
| 66 | Webasto Air Top 3500 | 36W |
| 100 | Bowthruster battery 12V 105Ah | |
| 101 | Start battery 12V 75Ah | |
| 102 | House battery 12V 105Ah | |
| 103 | House battery 12V 105Ah | |
| 104 | Battery charger Quick 12V 45A | 25A |
| 105 | Shunt | |
| 106 | Windlass | |
| 107 | Minus ditribution bus | |
| 108 | Windlass automatic switch | |
| 109 | Windlass relay | |
| 110 | Starter | 2.0 kW |
| 111 | Alternator | 115A |
| 112 | Engine control panel | |
| 113 | Engine | |
| 114 | Bowthruster | 2.2 kW |
| 115 | Float switch | |
| 116 | Bowthruster fuse | 200A |
| 117 | Bowthruster isolator | |
| 118 | Engine battery isolator | |
| 119 | Emergency isolator | |
| 120 | House battery isolator | |
| 121 | Relay VSR 125A | 125A |
| 122 | Relay VSR 125A | 125A |
| 123 | House battery test panel bep marine 600-DCT/LM | |
| 124 | Switchboard fuse | 40A |
| 125 | Automatic or manual bilge pump operation switch | |

PICTORIAL DIAGRAM OF ELECTRIC INSTALLATION MASTER POWER SUPPLY D-33

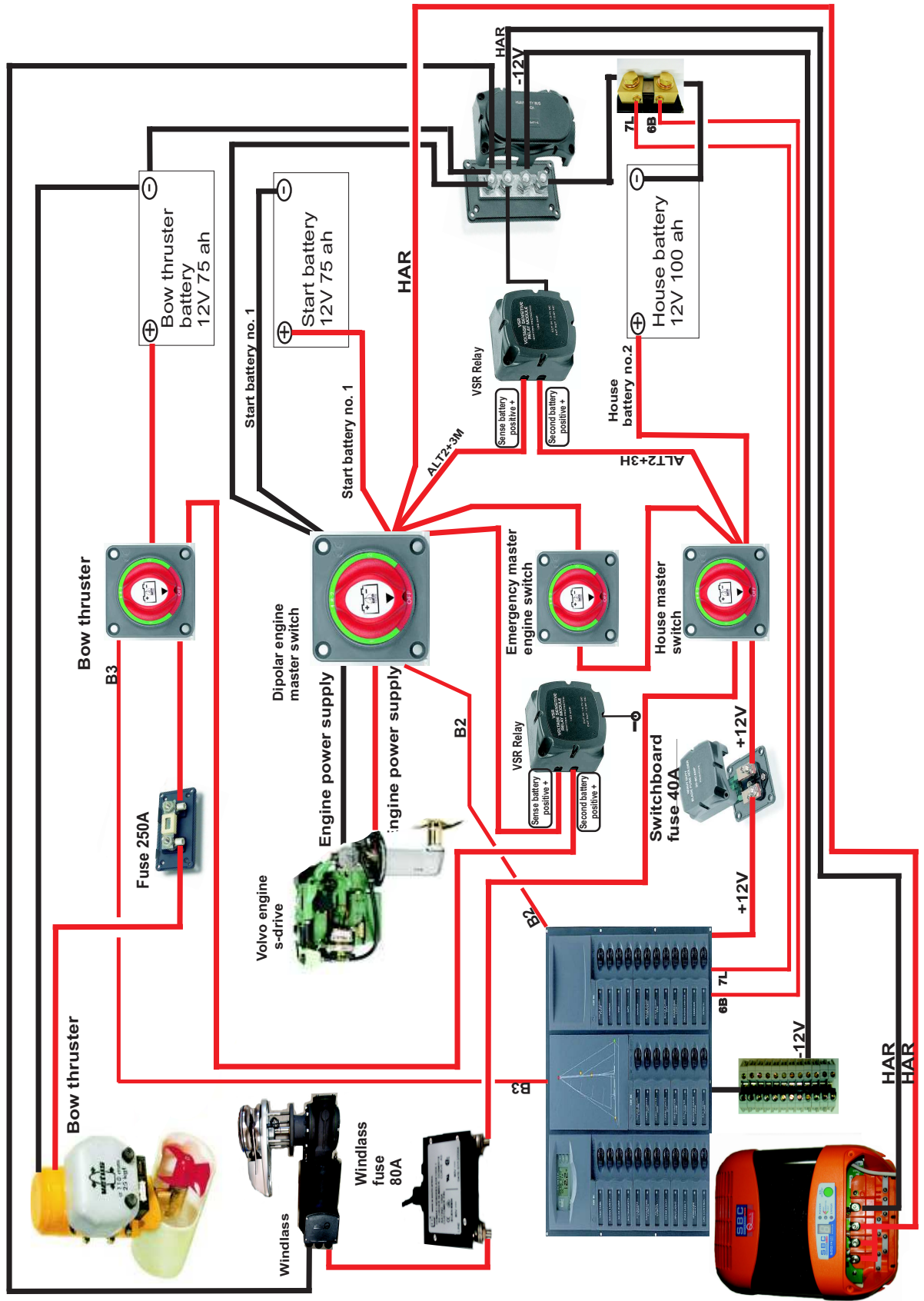

SENSORS CONNECTION

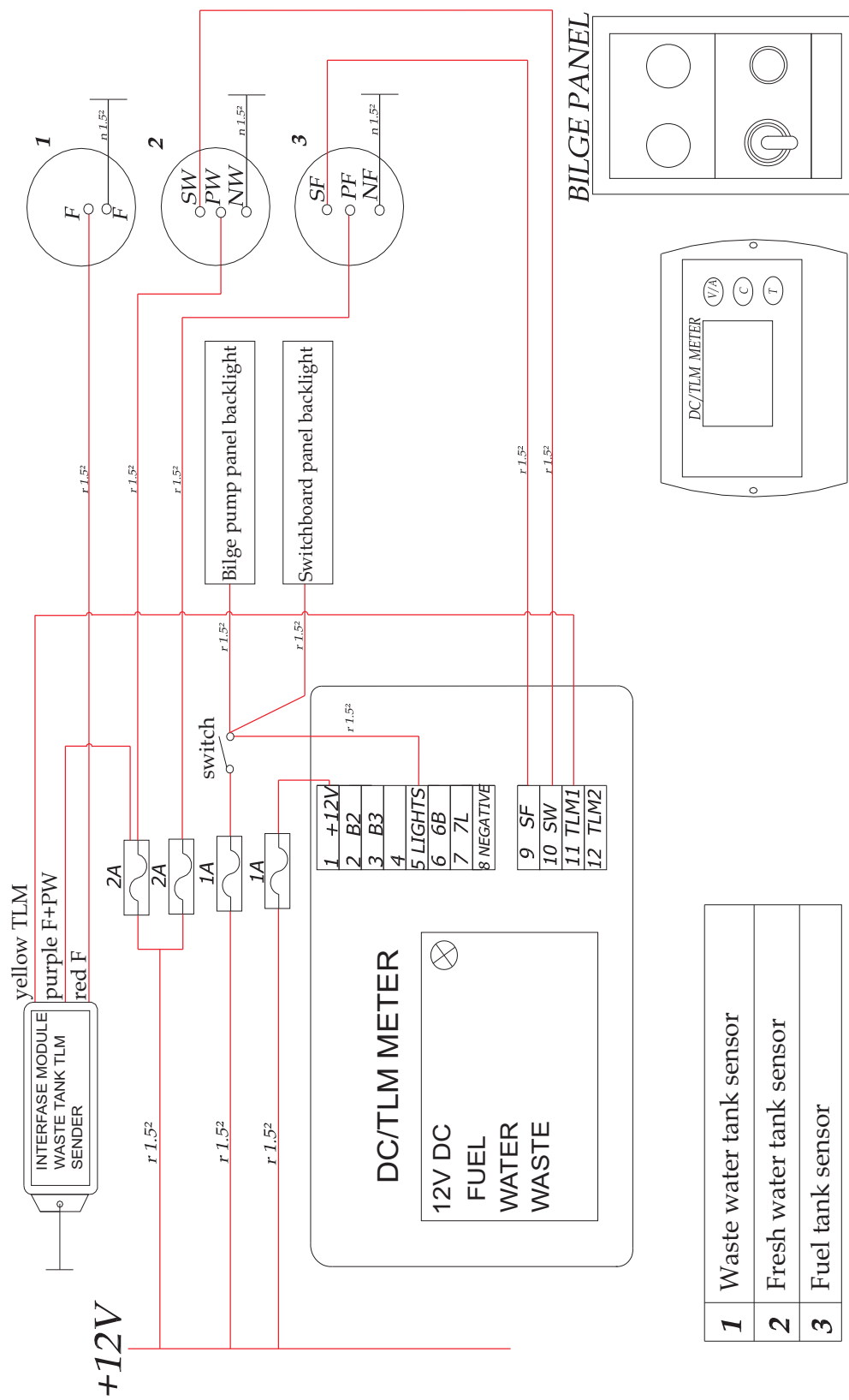

| | |
|----------|-------------------------|
| 1 | Waste water tank sensor |
| 2 | Fresh water tank sensor |
| 3 | Fuel tank sensor |

| | Electric installation scheme description | |
|-------------|--|-------------|
| <i>1</i> | Switchboard | |
| <i>1A</i> | Red navigation lamp | <i>25W</i> |
| <i>1B</i> | Green navigation lamp | <i>25W</i> |
| <i>1C</i> | Stern navigation lamp | <i>10W</i> |
| <i>6</i> | Top lamp | <i>10W</i> |
| <i>5</i> | Running engine signaling lamp | <i>25W</i> |
| <i>43</i> | Deck lamp | <i>35W</i> |
| <i>12</i> | Shower pump Jabsco 37202-2 | <i>120W</i> |
| <i>12C</i> | Johnson pump | <i>150W</i> |
| <i>7</i> | Bilge pump floating switch | |
| <i>30A</i> | Auto-manual bilge pump | <i>3,2A</i> |
| <i>15</i> | Electric toilet pump Jabsco | <i>200W</i> |
| <i>15A</i> | Electric toilet pump Jabsco | <i>120W</i> |
| <i>16</i> | 12V socket | |
| <i>10</i> | Fresh water pump Johnson WPS 5.0 | <i>150W</i> |
| <i>17</i> | Fridge | <i>7,5A</i> |
| <i>53</i> | Engine compartment fan Jabsco 35515-0010 | <i>4,3A</i> |
| <i>80</i> | Raymarine ST60+Wind St60+ tridata instrument | <i>1A</i> |
| <i>80B</i> | Smart pilot S1 systems | <i>6W</i> |
| <i>80A</i> | C-80 | <i>10W</i> |
| <i>28B</i> | Compass Olympic 135 | <i>10W</i> |
| <i>86</i> | Ray54E Marine VHF radio | <i>2W</i> |
| <i>13A</i> | Cabin lamp | <i>10W</i> |
| <i>13B*</i> | Cabin lamp | <i>10W</i> |
| <i>13C*</i> | Cabin lamp | <i>10W</i> |
| <i>13D</i> | Cabin lamp | <i>10W</i> |
| <i>13E</i> | Cabin lamp | <i>10W</i> |
| <i>13F</i> | Cabin lamp | <i>10W</i> |
| <i>13G</i> | Cabin lamp | <i>10W</i> |
| <i>13G</i> | Cabin lamp | <i>10W</i> |
| <i>13H</i> | Cabin lamp | <i>10W</i> |
| <i>13I</i> | Cabin lamp | <i>20W</i> |
| <i>13I1</i> | Cabin lamp | <i>20W</i> |
| <i>13I2</i> | Cabin lamp | <i>20W</i> |
| <i>13I3</i> | Neon lamp | <i>8W</i> |
| <i>13K</i> | Cabin lamp | <i>20W</i> |
| <i>13K1</i> | Cabin lamp | <i>20W</i> |
| <i>13K2</i> | Cabin lamp | <i>20W</i> |

| | | |
|-----------------|--|--------------|
| <i>PF</i> | Fuel tank sensor | |
| <i>F</i> | Waste water tank sensor | |
| <i>PW,SW,NW</i> | Fresh water tank sensor | |
| <i>87</i> | Radio stereo CD | <i>4x50W</i> |
| <i>82</i> | Electric cooker(option) | |
| <i>66</i> | Webasto Air Top 3500(option) | <i>36W</i> |
| <i>100</i> | Bowthruster battery 12V 105Ah | |
| <i>101</i> | Start battery 12V 75Ah | |
| <i>102</i> | House battery 12V 105Ah | |
| <i>103</i> | House battery 12V 105Ah | |
| <i>106</i> | Windlass | |
| <i>108</i> | Windlass automatic switch | |
| <i>109</i> | Windlass relay | |
| <i>114</i> | Bowthruster 2kW | |
| <i>118</i> | Engine battery isolator | |
| <i>119</i> | Emergency isolator | |
| <i>120</i> | House battery isolator | |
| <i>126</i> | Stereo radio/VHF radio switch on the steering pedestal | |
| <i>127</i> | Stereo radio speaker | |
| <i>127*</i> | Stereo radio/VHF radio speaker | |

LIGHTING INSTALLATION SCHEME

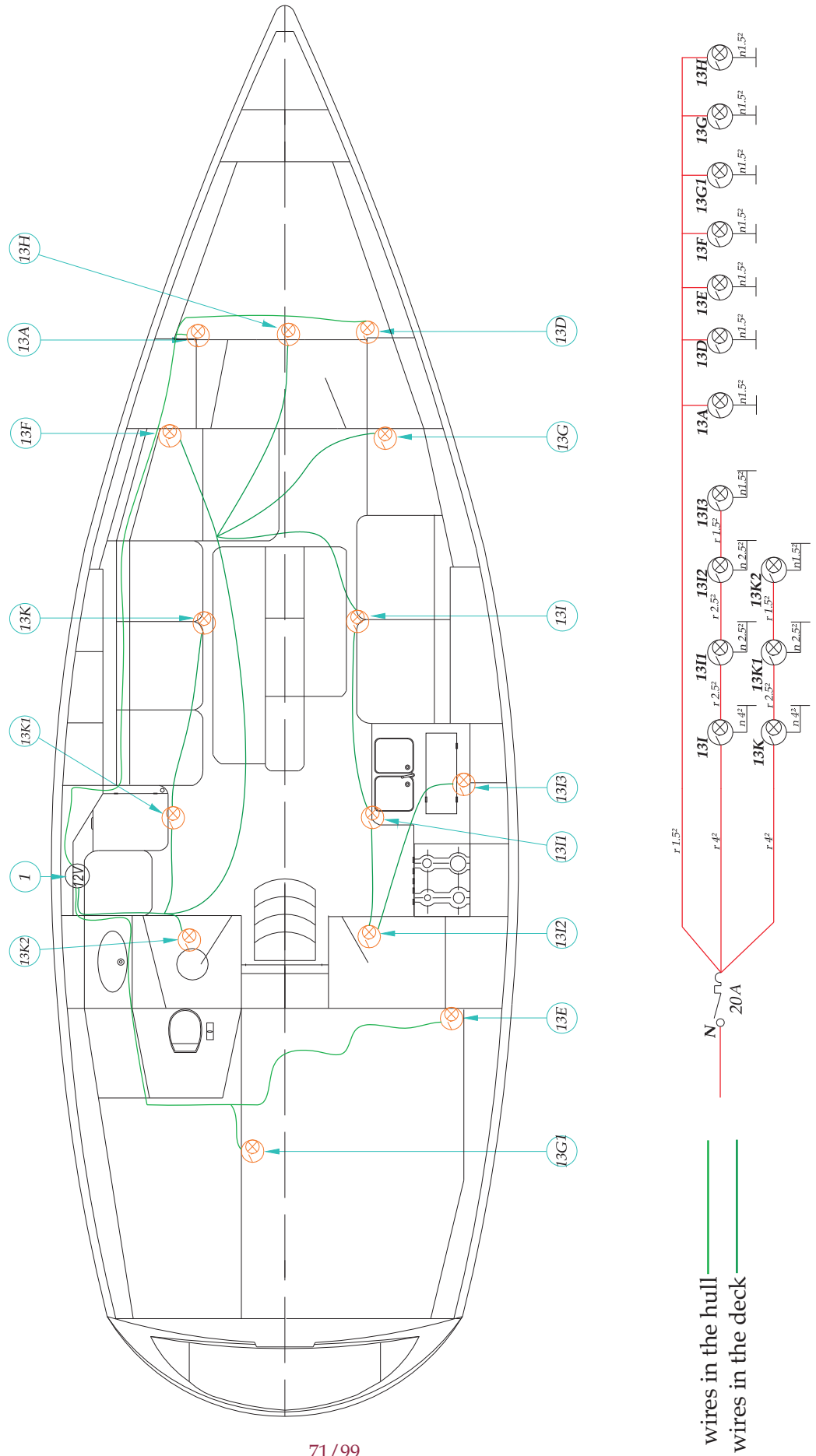

| | | |
|-------------|-----------------|-----|
| N | Cabin lamp fuse | 20A |
| 13A | Cabin lamp | 10W |
| 13D | Cabin lamp | 10W |
| 13E | Cabin lamp | 10W |
| 13F | Cabin lamp | 10W |
| 13G | Cabin lamp | 10W |
| 13G1 | Cabin lamp | 10W |
| 13H | Cabin lamp | 10W |
| 13I | Cabin lamp | 20W |
| 13I1 | Cabin lamp | 20W |
| 13I2 | Cabin lamp | 20W |
| 13I3 | Neon lamp | 20W |
| 13K | Cabin lamp | 20W |
| 13K1 | Cabin lamp | 20W |
| 13K2 | Cabin lamp | 20W |

LIGHTING INSTALLATION SCHEME (LED lamps version)

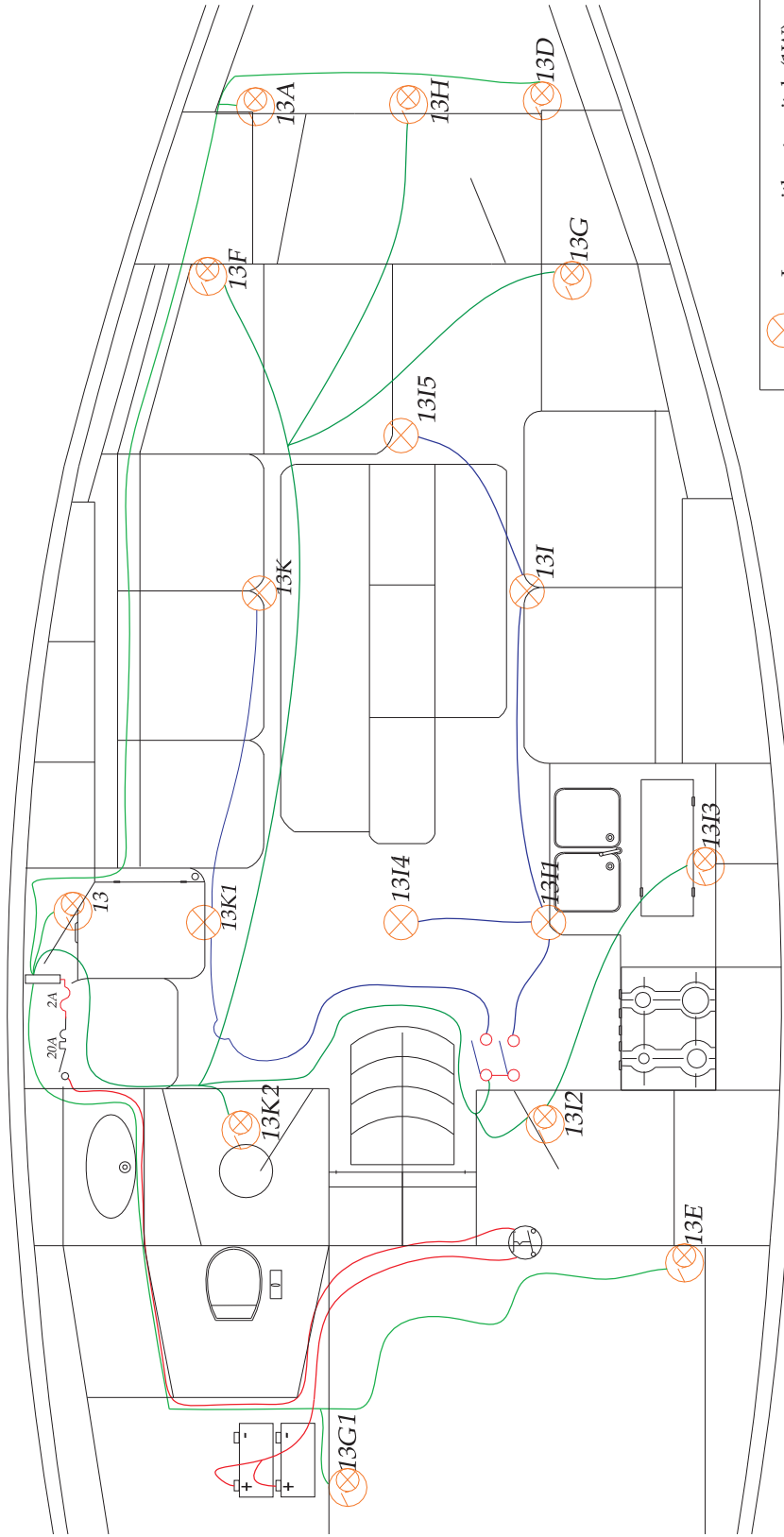

Lamps in the messroom can be turned on and turned off with a switch place next to the stairs. It works only if the house master switch and switchboard(cabin light) switch is turned on

| | | | |
|--|-------------------------------------|--|--|
| | wires in the hull | | Lamp without switch (1W) |
| | wires in the deck | | Lamp with integral switch(1W) |
| | wires in the deck | | Switch (on the switchboard panel) |
| | Distribution bus in the switchboard | | Switch of lamps in the messroom (0-off, 1-left, 2-right, 3-both) |
| | Master isolator (switch) | | Fuse in the switchboard |

115V/230V INSTALLATION

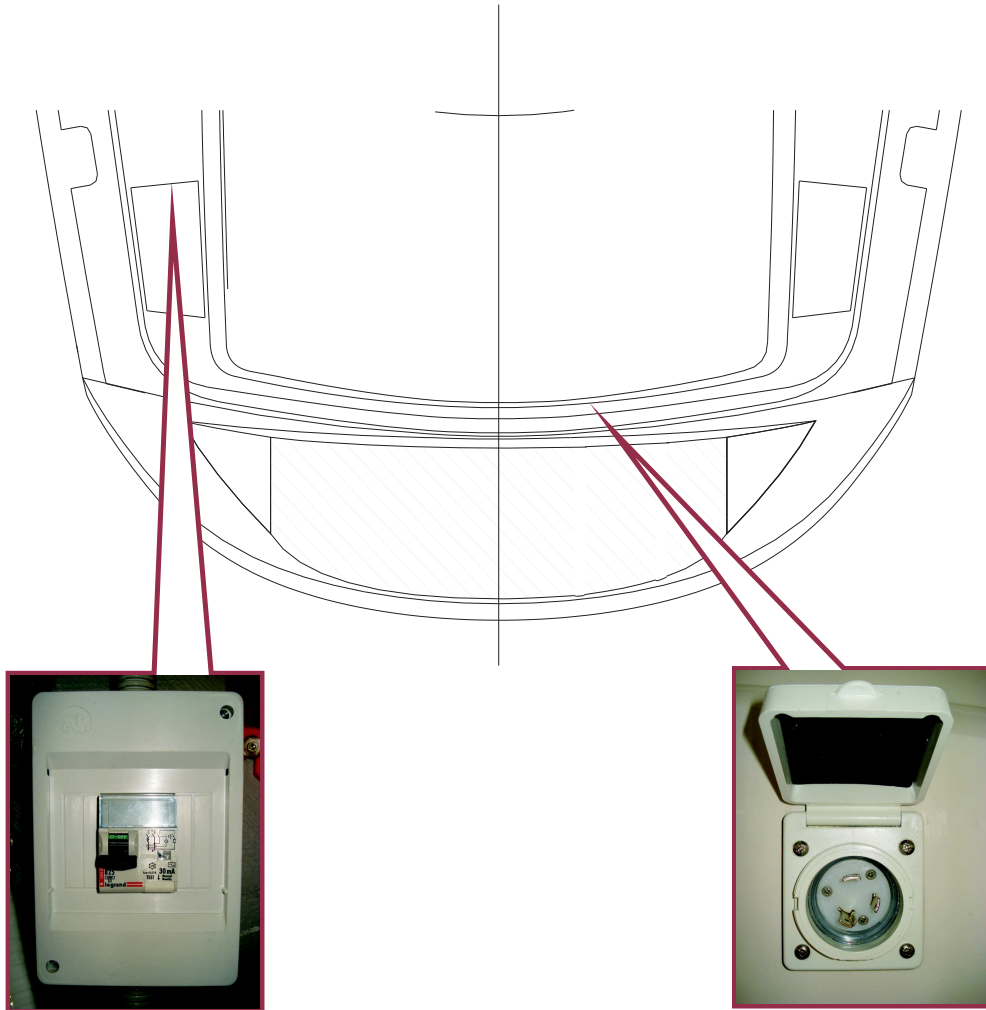

1. Differential circuit breaker
(inside left stern locker)

2. Master power supply
socket 115V/230V (shore)

115V/230V INSTALLATION

Electric installation 115V/230V is powered from external (shore) power supply with a cable with earthing system. It is used to supply the battery charger, the water heater (boiler) and 115V/230V sockets installed on the boat. Remember that when you use the shore power supply you should turn on the differential circuit breaker (photo 2 on page 74).

ADVICE

In order to reduce the threat of electric shock or causing a fire you should obey the following rules:

- before plugging or unplugging the external power supply you should turn off all the electrical appliances using 115V/230V voltage;
- keep the right order of actions when you plug and unplug the cable (when you plug: plug in the boat / shore supply cable in the boat before you plug it into the shore supply socket; when you unplug: unplug the cable on shore first and then from the boat socket.)
- do not modify the 115V/230V electric installation.

| <i>Nr</i> | 115V/230V installation scheme description | |
|-----------|---|------------------|
| <i>1</i> | Differential automatic switch | <i>25A</i> |
| <i>2</i> | Charger automatic switch | <i>10A</i> |
| <i>3</i> | Water heater automatic switch | <i>15A/10A</i> |
| <i>4</i> | Distribution bus in the switchboard | |
| <i>5</i> | Differential circuit braker Legrand P312 | <i>30 mA-25A</i> |
| <i>6</i> | Shore power socket | <i>30A</i> |
| <i>7</i> | Galvanic isolator | |
| <i>8</i> | Quick 12V battery charger | <i>25A</i> |
| <i>9</i> | Quick water heater | <i>1200W</i> |
| <i>10</i> | 115V/230V electric socket | |

115V/230V INSTALLATION AND RECEIVERS PLACEMENT SCHEME

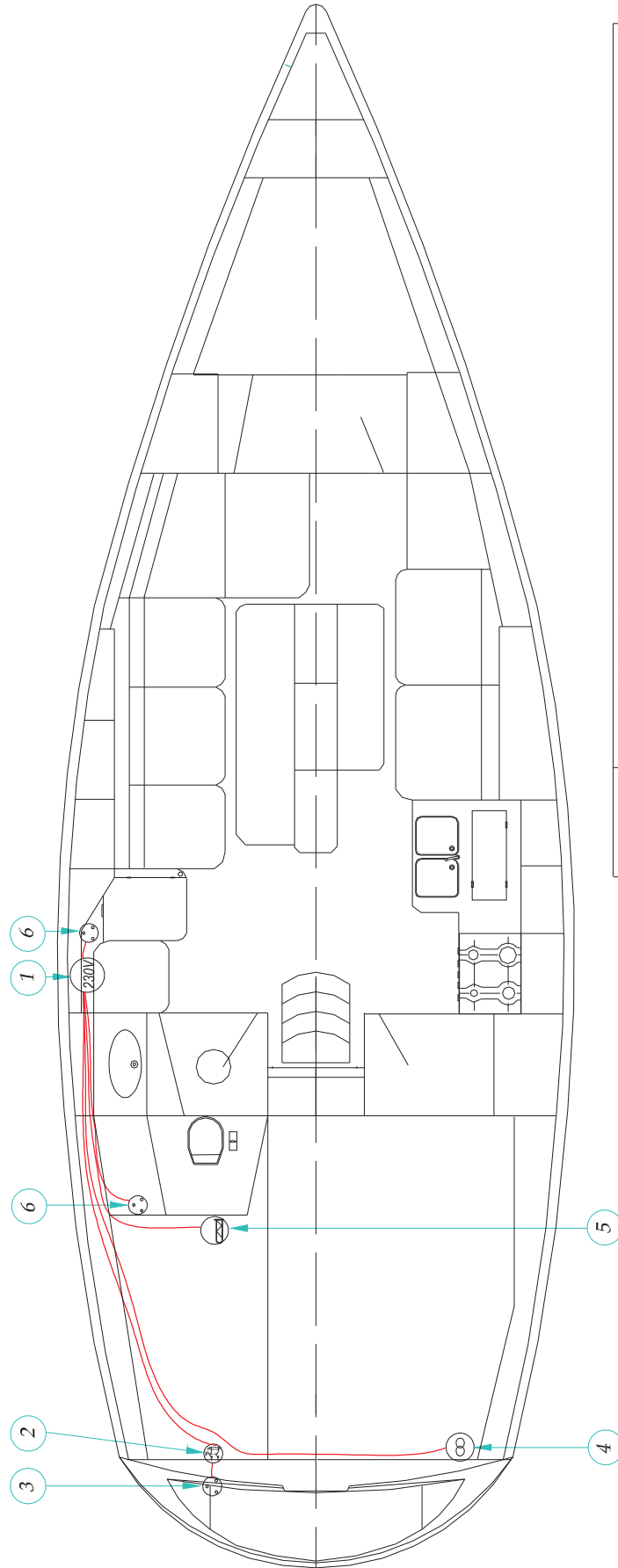

| | |
|---|--|
| 1 | Switchboard |
| 2 | Differential circuit breaker Legrand 30 mA |
| 3 | Shore power socket 15Amp 230V 50Hz |
| 4 | Quick 12V battery charger 25A |
| 5 | Water heater (Quick) 1200W |
| 6 | 230V socket |

THE FUNCTIONING AND DESCRIPTION OF CONTROL ACTIVITIES OF PARTICULAR ELEMENTS OF ELECTRIC INSTALLATION

DC/TLM Indicator

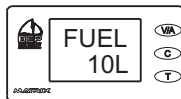

Fuel sensor signal- check the fuel.

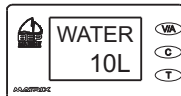

Water sensor signal- check the water.

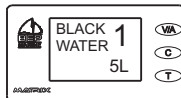

Waste water sensor signal - check waste water.

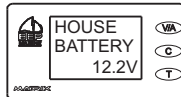

House batteries measurement- check batteries voltage

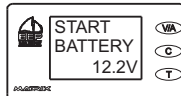

Start battery measurement- check battery voltage

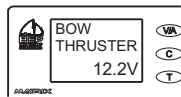

Additional battery measurement- check battery voltage.



The capacity of house batteries.

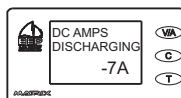

Control shunt measurement (current loss)- check by turning on particular receivers on the switchboard panel .

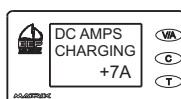

Control shunt measurement (charging from the alternator and battery charger)- check separately charging from the alternator and then from the battery charger.

SWITCHBOARD PANEL

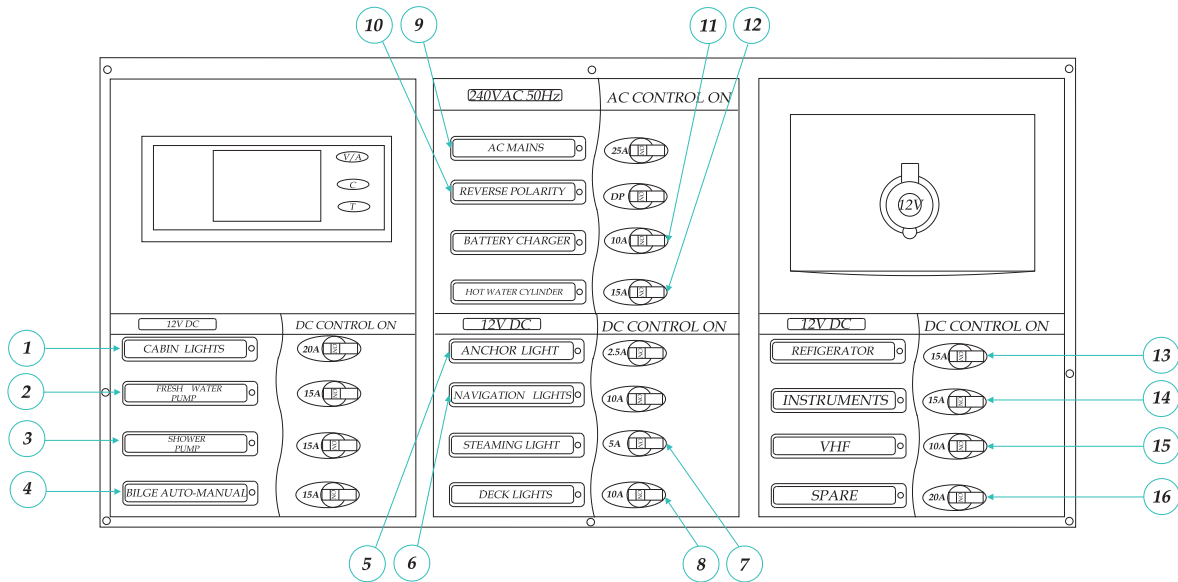

1. **Cabin lights**- light inside the boat - turn the lamps on one by one.
2. **Fresh water pump**- fill the fresh water tank with water, check if the pump stops automatically after filling to the full.
3. **Shower pump**- shower pump power supply- turn on the additional switch placed in shower cabin.
4. **Bilge auto- manual**- in order to check the bilge pump you should turn the master house switch off and turn on the bilge auto switch on the switchboard which is powered directly from the battery. When the pump is working the big red diode should be lit on the pump panel..
5. **Anchor light**- top light (circuit nr 6)
6. **Navigation lights**- green bow navigation lamp (circuit nr1);
 - red bow navigation lamp (circuit nr1);
 - white stern navigation lamp (circuit nr1). When you check the Navigation light you should take into account that they are additionally divided on three 3,15A fuses in the switchboard. That is why while checking you should open particular slots with fuses.
7. **Steaming light**- running engine signal (circuit nr 5).
8. **Deck light**- deck light (circuit nr 43)
9. **AC mains**- dipolar securing of the complete 115/230V installation. In order to supply the securing with power, you should turn on the differential current securing which is in the stern locker. .
10. **Reverse polarity**- when the **ac mains** securing is turned on, the lighting diode informs that in the shore power supply the plus and minus wires were changed but it does not mean that there is a problem caused by the faulty electric installation.

12. **Hot water cylinder**- boiler 115/230 power supply. You should turn on the boiler and wait 15-30 min. To check the temperature of the heated water.
13. **Refrigerator**- Refrigerator is turned on with a one switch on the panel. In addition, it is secured with a fuse.
14. **Instruments**- for example autopilot power supply , ST-60- check if all electronic instruments work properly.
15. **VHF**- VHF radio power supply.
16. **Spare**- spare place.

BILGE PUMP PANEL

Bilge pump:

- in order to check the bilge pump you should turn the master house switch off and turn on the bilge auto switch on the switchboard
- automatic mode- turn on auto mode on the additional panel (photo on the right) , and then add some water to the pump sensor to check if the pump starts automatically.
- manual mode-turn manual mode on the additional panel (photo on the right) and check if the pump works.



SWITCHBOARD PANEL LIGHTING

Black button in a silver frame is used to turn on the lighting of the markings on the switchboard panel, bilge pump panel and DC/TLM indicator.



CHARGING WITH QUICK BATTERY CHARGER 50A-115/230V

You should turn on the charger on the 115/230V switchboard panel with 12V master switches turned off because the installation was designed to make it possible to charge all the batteries automatically without boat user interference. During the first phase you should turn the charger on (big green button) and check the diodes (marked with arrows on the picture) to see if it works: the green and yellow diodes mean that the charger started and works properly. Then you turn on the master house switch and DC/TLM indicator, which you switch to DC AMPS function. If the indicator shows the current voltage e.g. 7A this means that the charger properly charges the house batteries. At the same time you may turn on several receivers and observe what happens on the indicator. If all the activities were carried out in accordance with the above instructions, the charger will work properly and ensures you that the electric installation is properly installed.



CHARGING WITH ENGINE ALTERNATOR 115 A

Before starting the control of charging from the Alternator you should check if 115/230V charger is turned off and if the red lamp on VSR transmitter (picture on the right) is not lit. The engine should be turned on with master bipolar switch and engine control panel. Then you turn on the master house switch and the DC/TLM which should be turned to DC AMPS function. The rest of the procedure should be carried out in the same way as in the case of Quick battery charger.



MAIN POWER SUPPLY

House switch- is responsible for power supply of the whole installation, switchboard panel and windlass. When checking you should make sure that in switch 'on' position the switchboard panel is not powered (except the securing of bilge pump, stereo radio memory and windlass panel).

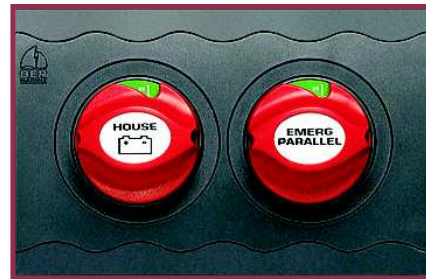

Emergency switch- in case of damage or de-charging of start battery it is responsible for engine emergency power supply. In order to check the proper functioning of the switch you should disconnect the start battery cable and observe if the engine starts from **house** battery when the master switches are turned on.

Start switch -is responsible for engine power supply. When checking the switch you should observe if engine control panel does not start when the master bipolar switch is turned off.

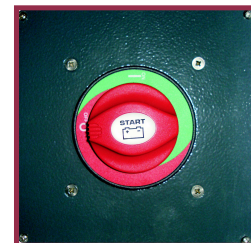

WINDLASS

In order to start the windlass you should turn on **Anchor** securing on switchboard panel, master **house** switch and main windlass securing (photo nr 1). After turning these securings on you should go to the bow of the boat and turn the windlass up or down roatation using windlass controller. Make sure that up and down marking are compatible with a given direction..



Windlass controller socket

BOW THRUSTER *

In order to start the bow thruster you should turn on the master switch (photo nr 2) installed in the bow part of the boat. Using the control panel you should turn on the right or left rotation of bow thruster. Make sure that left and right marking are compatible with appropriate direction.

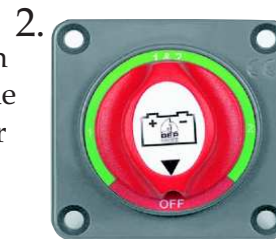

Bow thruster control panel (photo nr 3) is on steering pedestal. In order to turn the bow thruster on you should push two "on" buttons at the same time. When the type of the bow thruster changes, the type of control panel may also change.



*-Additional option

ELECTRONIC INSTRUMENTS

Before checking the electronic devices you should read the attached manuals.



The scheme below shows the placement of the sensors:

1. Speed sensor.
2. Depth sensor.

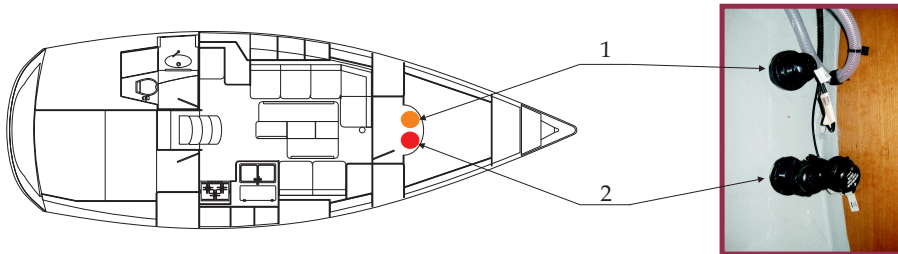

AUTOPILOT COMPASS*

The autopilot compass is placed in the locker in left stern cabin.

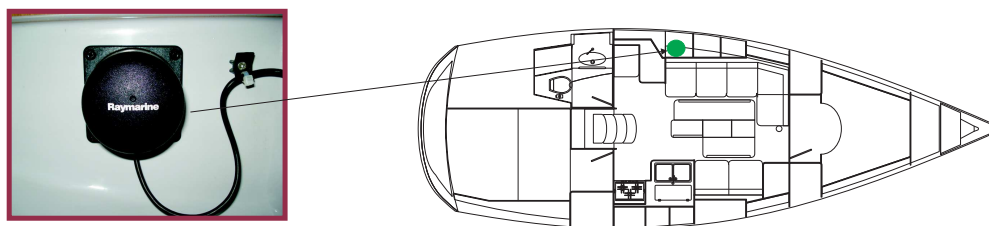

ELECTRONIC INSTRUMENTS WIRES

The schemes below present the distribution of optional electronic appliances wires. The appliances are not installed on the boat in standard version. The wires make it possible to add the electronic appliances presented on the schemes to the boat equipment.

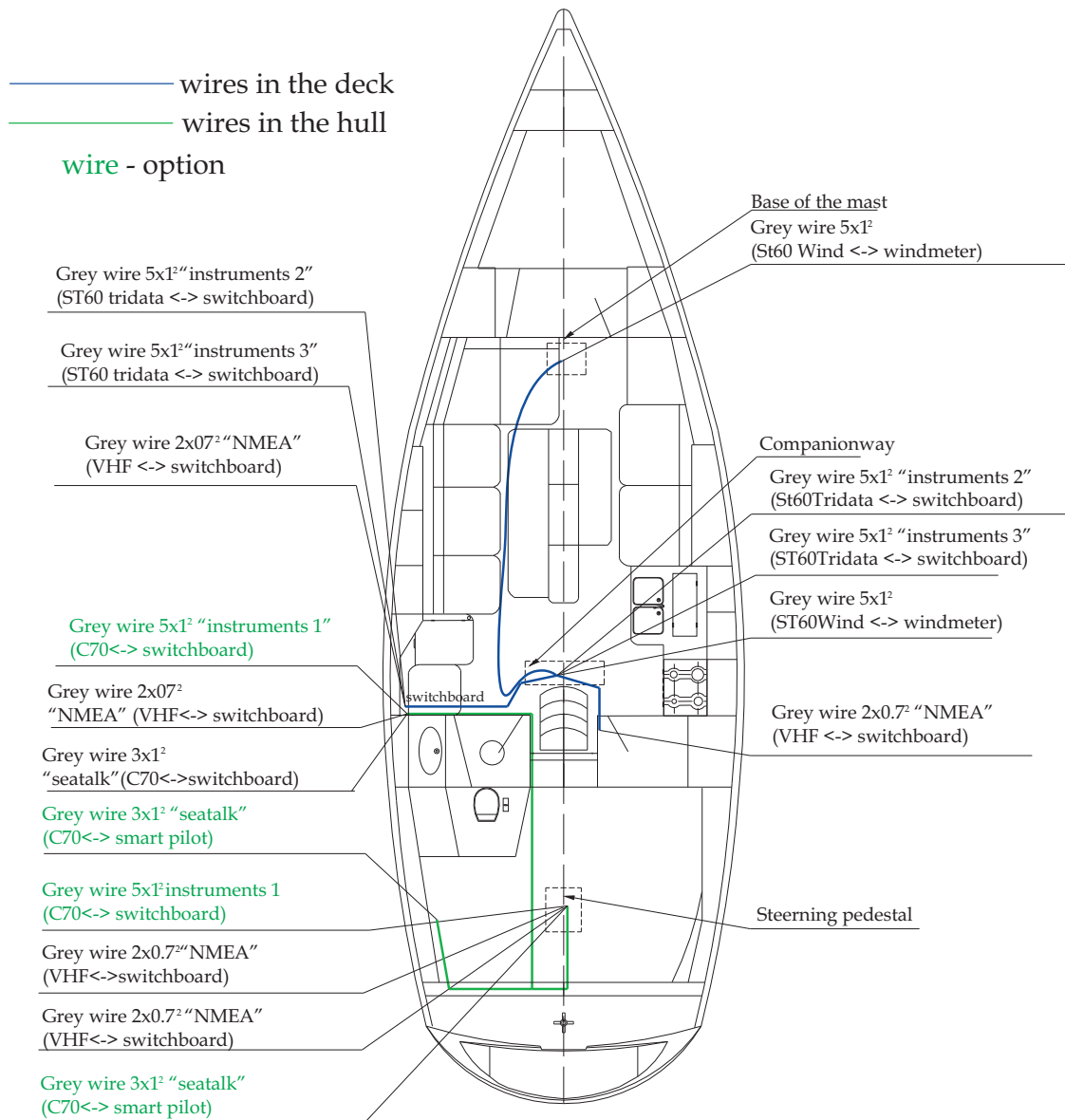

BATTERIES

12V electric installation is powered from the two 100 Ah batteries. They are powered with direct current from the engine alternator or 115/230V battery charger. This installation supplies the power yacht cabin lighting, house appliances and navigation light placed on the top of the mast and bow and stern pulpit. Additionally, the yacht is equipped with engine start battery.

ADVICE

Try to keep the batteries charging level at 70%. This will help the batteries to work longer.

When you are in a marine, use the shore power (alternating 115V/230V current) to charge the batteries.

Before going the open sea check the batteries and charging system.

ATTENTION !

Do not turn off the master switch START while the engine is running because may cause alternator damage.



ADVICE

When you leave the boat alone, turn off all batteries.

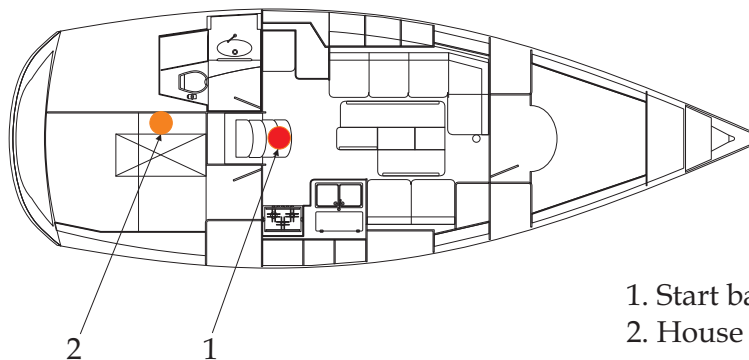

1. Start battery.
2. House battery.

BATTERIES MASTER SWITCHES

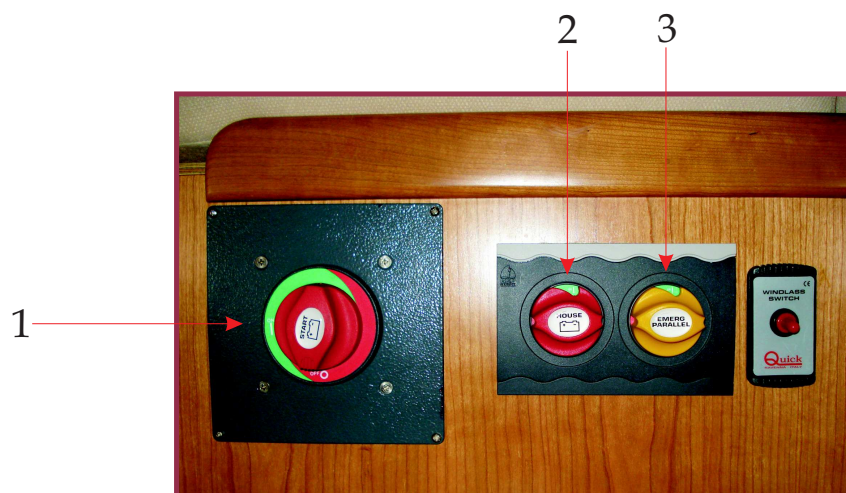

1. Dipolar START switch
2. HOUSE switch
3. EMERGENCY PARALLEL switch

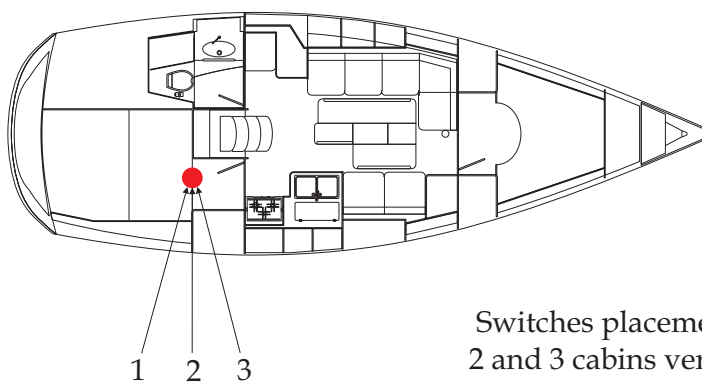

Switches placement for
2 and 3 cabins version

A detailed description of switches is shown on page.....

BATTERIES MAINTENANCE

ADVICE

- Keep the batteries clean and dry to avoid early consumption.
- Check the tightness of batteries connections and regularly lubricate them with vaseline
- After the end of sailing season disconnect and take the batteries out of the boat. Do the same if the boat is not used for a long time.

WARNING !

Be very careful when working with batteries. In case of contact of your body with electrolit, clean it immediately with cold water and visit a doctor



ADVICE

- Do not modify the electric system.
- Do not change the amperage of fuses for the safety of electric appliances.
- Do not install or change the appliances that excess the aperage in the electric system.

ATTENTION !

In case of electric system breakdown, turn off the power supply before starting the repair.



LAUNCHING

A very important operation is the initial launching of the boat. This launching and the first tests of different equipment shall be carried out in the presence of your dealer. Only then the warranty may cover the noticed equipment failure. The owner of the boat will be responsible for every next launching.

BEFORE LAUNCHING

- check the water intakes
- turn off the engine cooling water drain valve
- turn off all the water inlet and drain valves (sink, toilet, shower)

HOISTING THE BOAT

- Install two ropes (fore and rear).
- Install the crane belts on the positions (just under the fender bar) marked with stickers (photo).
- Check that no device is crushed by the belts.
- The belts should not be hooked directly on the crane hook because it may result in unusual compressive stresses on the hull. Instead use a gantry or a spacer with two belts.
- Hoist the boat slowly. Control the movements of the boats with ropes.

The marking of the crane belts placement



ATTENTION !

Do not stay on board or under the boat during hoisting.



AFTER LAUNCHING

- Open the valves and make sure that none of elements were damaged during launching.
- Before starting the engine refer to chapter 9 "Engine".

WINTER STORAGE

- Before leaving the boat for winter 'rest' you should remove such elements elements as kitchen equipment, the rest of food, clothes, security equipment, gas cylinders and batteries.
- Evaluate the condition of security equipment, check the expiration dates, check the liferaft.
- Take the advantage of lying up and draw up a complete inventory of the equipment.

PROTECTION AND MAINTENANCE

INSIDE OF THE BOAT

- Drain all the fresh water pipes and rinse them with water and vinegar, do not use a chlorine based products.
- Lubricate and close all the water inlet valves .
- Seal air inlets as much as you can.
- Leave the cabin doors and locker doors opened.
- Leave the cushions outside for long an dry them before putting them back into the boat.

OUTSIDE OF THE BOAT

- Rinse the hull and deck with water.
- Lubricate all the mobile parts (hinges, locks).
- Protect all the ropes against chafing.

ATTENTION !

Before leaving the boat for winter storage remember to empty the water installation. Otherwise the installation may get damaged.

ENGINE

Winterization of the engine is a very important matter during winter storage. Depending on the place of storage (land or water) it shall be carried out in two different ways.

ATTENTION !

The engine winterization should be carried out by a professional.



All the mentioned activities and directions are not the complete procedure of boat maintenance. The rest of the technical information you will get from Your dealer.

ENVIRONMENT PROTECTION

OIL

A well maintained engine should not have any leaks. In order to prevent the oil from getting to bilge and sea water, the engine bed was designed in the form of closed tube

There should be a special chemical substance on the boat for collecting the oil from water just in case of any leaks.

WASTE

It is obvious for all the sailors that the waste cannot be thrown into the water. The same situation is in case of biologically degradable waste. There should be a special place on the boat for waste storage.

NOISE

The noise significantly reduced by the exhaust pipe with a silencer. The rubber bed, elastic clutch, and the insulation of the engine compartment additionally reduce the noise. However, you should avoid a rapid change of engine revolution.

WAVING

The natural shores are very sensitive to waving so you should keep the right distance from them. The observation of waves made by the boat may help to adjust the speed in order to avoid too much waving. You should also observe the navigation signs.

COMBUSTION GASES

Regularly control the combustion gases that come out from the exhaust of your boat. Their colour should not be black or blue. In such case, you should change the engine air filter and this can be done by the boat owner. If this does not help, you should ask a qualified person to regulate the engine.

WARRANTY

1. DELPHIA Yachts Kot sp.j. with registered office in Warsaw as a producer guarantees that the purchased unit is free from any physical faults for the time of:
 - a.) 24 months for hull, interior furniture and produced elements;
 - b.) 12 months for gelcoat;
2. The boat must be used according to the conditions described on the CE plate.
3. The warranty is valid from the date of delivery of the boat and issuing the invoice by the dealer.
4. In case of replacement of the hull the term of warranty starts from the moment of replacement. In case of removing slight faults, the warranty is prolonged for the period of time between informing the dealer and removing the faults.
5. As a physical fault we understand a fault decreasing the value of the boat or its usefulness that makes it impossible to use the boat according to the intended purpose. A guarantee repair does not cover the activities described in the manual, which the user is obliged to do on his own and for his own cost.
The choice of the manner in which the fault will be removed depends on the issuer of the warranty who can do it by the means of repair or replacement of the faulty element or the whole equipment
6. The complaint within the time of warranty validity will be accepted under the condition that the faulty equipment will be delivered or shown together with the appropriately filled in guarantee form (including the equipment description, date of sale, seller's company stamp, signature of the issuer of guarantee form and buyer's signature).
7. The warranty does not cover the transport and loading accidents as well as the damage caused by these activities.
8. By the guarantee repair we understand special activities carried out by DELPHIA Yachts Kot sp.j. in order to remove the faults covered by the warranty.

-
9. The warranty is not valid if the boat is used for making profit.
 10. In case of making use of the rights covered by warranty, the user is obliged to inform DELPHIA Yachts Kot sp.j. about the complaint in written form describing the existing fault within seven days from the moment of discovering the fault.
 11. After receiving the complaint DELPHIA Yachts Kot sp.j. is obliged to inform the user in written form within 14 days if the complaint is accepted or not. The lack of the answer from DELPHIA Yachts Kot sp.j. is equal to accepting the complaint. In the above mentioned period of time DELPHIA Yachts Kot sp.j. may send the service to the user in order to verify the information concerning the complaint reported by the user.
In case of a complaint not covered by the warranty, the customer will be charged for sending the specialist if he knew or should have known that the complaint is not covered by the warranty.
 12. The warranty for materials, instruments and equipment installed by DELPHIA Yachts and produced by suppliers of DELPHIA Yachts Kot sp.j. is transferred on the customer.
 13. The fault of the equipment will be removed by DELPHIA Yachts Kot sp.j. within 14 days from the date of accepting the complaint. If the removal of the fault is very complicated and takes much time, the repairment period will be prolonged. DELPHIA Yachts Kot sp.j. will do its best to remove the faults in the possible shortest period of time.
 14. A report is written after the removal of the fault. It is signed by the user and DELPHIA Yachts Kot sp.j. service.
The refusal of signing the report by the user results in signing the report only by DELPHIA Yachts Kot sp.j. after the photographic documentation of the fact of removing the fault.
 15. The boat should be exploited in accordance with the manual. Otherwise the warranty is not valid.

16. The warranty does not cover:
 - a) Defects resulting from usual wear and tear.
 - b) Mechanical, thermal, chemical defects and any other defects caused by actions or negligence of the user or third persons and by external factors.
 - c) Defects resulting from the boat exploitation inconsistent with the boat user's manual and the installed equipment user's manual supplied by DELPHIA Yachts Kot sp.j.
 - d) Defects resulting from modifications or changes to design, performed by the user or third persons.
 - e) Purposeful damage to the boat
17. The rights under the guarantee may be exercised only after presenting valid guarantee card to the service staffj.
18. The guarantee card is valid only in connection with purchase receipt.
19. The Guarantor shall not assume any liability for loss, damage or destruction of he equipment resulting from other causes than inherent defects of the Equipment.



PERSONAL NOTES

A series of horizontal dotted lines spanning the width of the page, intended for writing personal notes.



D



Handwriting practice area consisting of 20 horizontal dotted lines.

