



Operation Manual

SEABOB RAVEJET
SEABOB JET 4.12
SEABOB CAYAGO VX2
SEABOB CAYAGO F7



Introduction

Congratulations on the purchase of your new SEABOB! The SEABOB is an innovative water-sports craft that allows you to move through water virtually silently and ecologically friendly without producing emissions. In developing the SEABOB, special attention has been given to hydrodynamics and ergonomic handling. The SEABOB impresses with its exclusive design coupled with high performance and advanced technology.

Like all watercraft, the SEABOB requires that operators take specific precautions when using it. For this reason, we urge you to read through the Operation Manual carefully – in particular, the safety information and the instructions on proper use – before operating the SEABOB.

So get ready to dive into a fascinating new world! We wish you many hours of fun with your SEABOB!

The following symbols are used in this Operation Manual to bring your attention to important information:



Caution! Danger of injury and / or death. This symbol indicates that operating the SEABOB involves the risk of injury to, or death of the operator or other persons.



Not heeding this information may result in damage to or destruction of the SEABOB or other property.

Note: Notes provide you with important operating information or other information that can help you to understand the operation of the SEABOB better.

CAYAGO AG constantly works to optimise its products to keep pace with the advance of technology. As a result, CAYAGO AG reserves the right to change or modify the product characteristics specified in this Operation Manual at any time without prior notice. Characteristics and functions described and illustrated in this Operation Manual may differ from the actual characteristics and functions of the product.

SEABOB is a registered trademark.

Contents

1. Safety information	6
1.1 Special safety information	7
1.2 General safety information	9
1.3 Safety information for diving to a depth of up to 2.5 m	14
1.4 Safety information for diving to a depth of more than 2.5 m	15
1.5 Safety information concerning the accumulator box	17
1.6 Safety information concerning the SEABOB CAYAGO F7 model	19
2. Proper use	20
2.1 Operation on the water surface	20
2.2 Diving	22
3. Included in delivery	23
4. Description of the device	24
4.1 SEABOB housing (SEABOB RAVEJET and SEABOB JET 4.12 models)	24
4.2 SEABOB ACS housing (SEABOB CAYAGO VX2 and SEABOB CAYAGO F7 models) ACS	25
4.3 Accumulator box ACS (ACS = Accumulator Change System) ACS	26
4.4 Right Controlgrip	26
4.5 Left Controlgrip	27
4.6 Drive unit	27
5. Operation	28
5.1 Start-up	28
5.2 Charging the accumulator box	28
5.3 Installing the accumulator box ACS (Accumulator Change System) ACS	32
5.4 Operating the SEABOB	35
5.4.1 Controls and display panel	35
5.4.2 Arrangement of the controls	36
5.4.3 Using the controls	36
5.4.4 Display (operation display)	37
5.4.5 Off mode (air transport / storage) – switching on / off	38
5.4.6 Sleep mode – switching on / off	39
5.4.7 Stand-by mode	40
5.4.8 On mode	41
5.4.9 Charge mode	41
5.4.10 Charge display	42
5.4.11 Displaying serial numbers	43
5.4.12 Entering PIN (Owner-PIN / User-PIN)	43
5.4.13 Settings	44
5.4.14 Operation	45
5.4.15 IrDA (infrared interface)	45

5.5 Before starting	46
5.6 Operation on the water surface	47
5.6.1 How to navigate your SEABOB	47
5.6.2 Accumulator box charge state and emergency reserve	49
5.7 Diving to a depth of up to 2.5 m	50
5.7.1 How to dive with your SEABOB	50
5.8 Diving to a depth of more than 2.5 m	51
5.8.1 Setting the maximum diving depth	51
5.8.2 Adjusting the buoyancy of the SEABOB	52
5.9 After use	53
5.10 Switching off the SEABOB to Sleep mode	54
5.11 Detaching the accumulator box ACS (Accumulator Change System) ACS	54
5.12 Storing the SEABOB and accumulator box ACS ACS	55
5.13 Air transport / transport of the SEABOB and accumulator box ACS ACS	57
5.14 Switching off the SEABOB for storage or transport	58
6. Care	59
6.1 Cleaning the SEABOB, accumulator box and charger	59
6.2 Changing the seals	60
7. Troubleshooting	62
7.1 SEABOB cannot be switched on	62
7.2 Accumulator box emits an acoustic signal.....	63
7.3 Motor does not run	63
7.4 Impeller does not turn (no thrust)	64
7.5 Stator / impeller blades are bent or broken (low thrust or no thrust at all)	65
7.6 Powergrip does not function properly	68
7.7 Display does not show entire image	68
7.8 Moisture present on high-current connecting plates (on models with Accumulator Change System) ACS ...	69
7.9 Moisture present in charging socket	69
8. Technical specifications	70
9. Disposal	75
10. Replacement parts	76
11. Accessories	77
12. Service	78
13. Imprint	79

 These chapters only relate to the SEABOB CAYAGO VX2 and SEABOB CAYAGO F7 models with Accumulator Change System (ACS).

Caution! Please read the following information!

1. Safety information

The SEABOB is a state-of-the-art device. It conforms to current standards and is safe to operate. Nevertheless, using the device in an unintended fashion or not heeding the safety information may cause injury to, or death of the operator and / or other persons. In addition, the SEABOB and other property of the operator or other persons may be damaged or destroyed.

For this reason, we urge you to read the Operation Manual and the safety information contained in the Manual carefully before you operate your SEABOB for the first time. The information contained in the Operation Manual will help you to operate the SEABOB safely, protect yourself and others from hazards, and prevent damage to the device and other property.

Keep this Operation Manual in a safe and easily accessible place for reference whenever needed. Please do not throw away the packaging. It can be used later to provide optimum protection for the device (for example, when sending the device in for service).

1.1 Special safety information

Please pay particular attention to the very important safety information below! This information is also provided on safety labels that are directly attached to the SEABOB, accumulator box and charger for easy reference:



Special safety information on the SEABOB

- Important! Observe Operation Manual!
- Suitable only for swimmers aged 16 or older!
- Do not use as swimming aid!
- Wear life jacket when away from shore or boat!
- Wear body-hugging clothing (without loose straps or bands)!
- Wear bathing cap or hair net if hair is shoulder length or longer!
- Do not reach into openings (jet channel)! Rotating parts!
- Use only in sheltered waters!
- Do not use in strong currents, heavy swell or impaired visibility!
- Do not use in areas occupied by swimmers or divers!
- Maintain distance (minimum 5 m) to other persons and objects!
- Always observe accumulator charge state and return to shore in time!
- Do not store in sunlight or closed motor vehicle!



Special safety information on the accumulator box

- Important! Observe Operation Manual!
- Do not heat beyond 60 °C / 140 °F!
- Do not store in sunlight or closed motor vehicle!
- Do not short circuit!
- Do not open!
- Do not puncture!
- Do not knock!
- Do not burn!
- Use only chargers supplied by SEABOB manufacturer!
- Charge only in dry locations! Never detach accumulator box ACS in water!
- Never transport fully charged accumulator box by aircraft or over long distances!
- Observe instructions on charging, discharging, storage and transport!
- If instructions are ignored, flaming gases can be discharged through safety valve causing serious injury!



Special safety information on charger

- Important! Observe Operation Manual!
- Do not expose to direct sunlight! Do not open!
- Use only with clean and dry plug connections!
- Never use if cables or plugs are damaged!
- Charge only in dry, cool and well ventilated locations!
- Do not cover! Ensure free air circulation!
- Heats up during charging process! Allow to cool before handling!



Never expose the SEABOB, accumulator box and charger to high temperatures (max. 60 °C / 140 °F) caused e.g. by open fire, direct sunlight or by storage inside a closed motor vehicle or boot. If exposed to heat, flaming gases can be discharged through the accumulator cells' safety valve causing serious injury. In addition, the LCD display will turn black if exposed to heat and may become irreparably damaged.



Never transport a fully charged accumulator box by aircraft or over long distances. The accumulator box should only be partially charged during transport (charge state "air transport / storage"). Only switch off the SEABOB for transport when the aircraft symbol is displayed. If instructions are disregarded, flaming gases can be discharged through the safety valve causing serious injury!

1.2 General safety information



General safety information concerning the user

- Only skilled and experienced swimmers aged 16 and older are allowed to use the SEABOB.
- Due to the high power output of the device, children and young people under 16 years of age should not be permitted to operate the SEABOB. As with all motor vehicles, persons operating the device must do so responsibly and with proper foresight.
- Use of the SEABOB by persons with pacemakers is not permitted. The strong magnetic fields created by the motor and current-carrying cables may cause severe damage to pacemakers, resulting in possible death.
- Use of the SEABOB by pregnant women is not permitted. During operation, the SEABOB may press up against the abdomen of pregnant women and / or the jet of water coming out of the device may come into contact with the abdomen.
- Never use the SEABOB while under the influence of alcohol, medication or drugs. Persons using the SEABOB must be able to react quickly. Alcohol, medication and drugs can considerably inhibit the ability of persons using the device to react quickly.
- Use the SEABOB only if you are completely healthy. Diving even if you only have a light head cold may cause problems when you try to equalise the pressure in your ears.
- Only wear body-hugging clothing (without loose straps or bands) when using the device. Wear a bathing cap or hair net if your hair is shoulder length or longer. The device is equipped with the smallest protective lamellas possible. Nevertheless, it is technically impossible to fully prevent objects, in particular pieces of clothing, thin cords or shoulder-length hair, from entering the jet channel and getting wrapped around the drive shaft due to the extremely high suction power of the jet drive. Should this occur, there is a risk of injury.
- Wear a life jacket when you are away from the shore or boat. Do not stray too far from the shore or the accompanying boat. Maintain a distance that is short enough, so that you can swim back by yourself in case of emergency. Be aware of any currents in the area that could carry you away.
- For better visibility, wear diving goggles. Attention! Despite every precaution taken, it is still possible for diving goggles to come off during operation of the SEABOB and for contact lenses to be lost.
- Water spraying against and over your body can not only be strenuous, but also takes away body heat. We recommend wearing a diving suit that provides adequate warmth.



General safety information concerning the SEABOB

- Never reach into the jet channel where the impeller is rotating. The closely fitted protective lamellas with their special, hydrodynamically optimised profile allow water to enter and exit the device without any obstructions. Always keep an eye on persons – especially children and young people – who are close to the SEABOB to ensure that they do not attempt to reach into the jet channel.
- Check that the jet channel cover is not damaged in any way and is attached correctly and firmly in position. Never remove the protective lamellas. Caution! The rotating impeller may cause injury.
- Make sure that no sand, dirt, stones, rope or other foreign objects get into the jet channel. Never remove foreign objects from the jet channel while the SEABOB is in the water. Danger of injury!
- Only remove the jet channel cover after you have completely switched off the SEABOB (Off mode). On models with the Accumulator Change System (ACS), first detach and remove the accumulator box ACS from the SEABOB. Caution! The impeller may be rotating. Contact with the impeller when it is rotating can cause serious injuries.
- Never place any objects into the jet channel by hand. Doing so can cause injury.
- Never leave the SEABOB unattended to prevent children or other inexperienced persons from using it. Switch off the SEABOB after use (Sleep mode).
- The SEABOB is a heavy device. Ensure that the SEABOB does not fall on you or other persons in the water or on land. Should this occur, there is a risk of injury.
- Always place the SEABOB, accumulator box and charger in the shade. It is important to remember that the SEABOB, accumulator box and charger will get hot naturally if left in the sun too long. Caution! Touching hot surfaces may cause burns. If exposed to heat, flaming gases can be discharged through the accumulator cells' safety valve causing serious injury! In addition, the LCD display will turn black if exposed to heat and may become irreparably damaged.
- Moor the SEABOB safely if you decide leave it in the water for a short time. Ensure that the SEABOB cannot become unattached, injure others or obstruct their path.
- Never detach or remove the accumulator box ACS (Accumulator Change System) from the SEABOB ACS while the device is in the water. Always take precautions to prevent the high-current connecting plates on the accumulator box and SEABOB from coming into direct contact with the water. If this occurs, a short circuit may result, causing irreparable damage to the SEABOB's electronic system. Water, especially salt water, is highly conductive of electricity. As a result, water seeping into the accumulator box may cause flaming gases to be discharged through the accumulator cells' safety valve causing serious injury.

- Before charging the accumulator box, check that the charging socket and charging plug are perfectly clean and dry. Never open the sealing cap on the accumulator box charging socket while the SEABOB is in the water. Wet and / or dirty plug connections may cause a short circuit while the accumulator box is being charged or even before this process is begun. If a short circuit occurs, it can cause irreparable damage to the charging contacts of the SEABOB. Caution! Short circuits can cause fires.
- Always ensure that the Powergrip is functioning properly. When you release the Powergrip, the SEABOB should immediately switch off. The Powergrip should be able to move freely in all positions. When released, it should always return unobstructed forward to the Off position. A damaged, sticking or bent Powergrip should be repaired or replaced immediately. If the Powergrip is not functioning properly, you can stop the motor by tapping the red button repeatedly until the power is displayed as "0 %".
- Never stick sharp objects into the depth sensor or do anything else that could damage the depth sensor. Prevent all dirt, sand, polish or other material from getting into the water inlets on the depth sensor. A damaged depth sensor or dirty inlets can impair operation of the device, even leading to complete failure. Always rinse out the depth sensor thoroughly with fresh water to prevent the build-up of salt deposits. Use a garden hose or similar equipment for cleaning. Never use a high-pressure hose or steam jet. If the depth sensor is damaged or the inlets are dirty, the motor's safety cut-off will not function at the set maximum diving depth (default setting 2.5 m). This may damage the health of the user.
- Never open the SEABOB yourself. Repairs and maintenance work on the SEABOB that go beyond the procedures described in Chapter 6 "Care" and Chapter 7 "Troubleshooting" may only be carried out by an authorised technician. Work of this type is dangerous and may result in severe injury or cause damage to the SEABOB if not carried out by an authorised technician.
- Never alter or modify any part of the SEABOB, accumulator box or charger. Doing so may result in serious injury or death.
- If you detect any damage to the SEABOB, in particular to the accumulator box, charging socket and sealing cap, or seals between the SEABOB and accumulator box ACS (Accumulator Change System), immediately stop operating the device and contact the manufacturer or your specialist dealer.



General safety information concerning operation

- SEABOB operators are not afforded any special rights with regard to operation of the craft. Operators must act responsible and prudently, taking all precautions that may be necessary.
- Only use the SEABOB in sheltered waters and when accompanied by others or under the constant supervision of another person who can provide immediate assistance in case of emergency.
- Do not operate the SEABOB in strong currents, strong wind (maximum wind force 4), bad weather or impaired visibility. By doing so, you put yourself and others in danger. Never use the SEABOB during a thunderstorm! Get out of the water as quickly as possible before the storm begins. Not doing so may result in serious injury or death. Always be prepared for a sudden change in the weather. Always check the weather forecast before you set out, and pay close attention to local weather conditions.
- Do not use the SEABOB in a heavy swell (significant wave heights up to 0.3 m maximum and occasional waves of 0.5 m maximum height). The SEABOB may seriously injure you or other persons. You can become separated from the SEABOB, and / or it may be thrown with great force onto you or other persons by a wave, particularly when in the surf.
- Hold on to the two Controlgrips on the SEABOB securely. The force of acceleration can be very high, especially when starting.
- To brake, hold on to both SEABOB Controlgrips securely, and release the Powergrip in your right hand so that it can move forward. The motor will stop, and the resistance of the water will slow you down. Be aware that it can take around 2-3 m for you to come to a complete stop if you are travelling at full speed. You can reduce the distance it takes you to come to a complete stop by turning the SEABOB sharply to the side and straightening up without letting go of the craft. This helps you to maintain control of the SEABOB and increases the water resistance considerably, so that you can come to a complete stop as quickly as possible.
- If the SEABOB is released while travelling at full speed, the craft may continue moving up to approx. 3 m and may briefly dive under the water to a depth of up to approx. 2 m. When this occurs, there is the risk that persons may be injured and foreign objects may be damaged. Also the SEABOB may be damaged, particularly if the water is too shallow and the craft hits the bottom.
- Do not use the SEABOB in areas occupied by swimmers or divers. Danger of collision and injury! If crossing such areas is absolutely unavoidable, operate with a maximum power of 10 % on the water surface.

- To prevent collisions, always maintain a safe distance (minimum 5 m) to other swimmers, watercraft or any objects that may be in the water. A collision may result in serious injury to you and other people. In particular, long hair or pieces of clothing of other people can get sucked into the jet channel. Should this occur, there is a risk of injury. In addition, the SEABOB may also be damaged considerably.
- Always avoid routes travelled by watercraft. The SEABOB housing is made of plastic and, for physical reasons, is unable to reflect radar waves adequately. Take into account the speed at which other watercraft are approaching. Another SEABOB may also approach quickly or appear suddenly. Keep an eye on what is happening farther up ahead. Beware of collisions!
- The SEABOB is not equipped with lights and, for this reason, is not suitable for operation at night. Do not operate the craft after sunset or before sunrise. Doing so can lead to collisions with other watercraft or obstacles.
- Do not operate the craft in water that is less than 1 m deep. Doing so can cause injury to you or damage to the SEABOB as a result of hitting underwater objects. Stay away from the immediate shore, and never attempt to steer the SEABOB onto the beach, shore or onto land of any kind. Be very careful of rocky bottoms, reefs and stones.
- The operating time of the SEABOB is limited. For this reason, you should always keep an eye on the display showing the remaining operating time, and return to the shore or accompanying boat in time.
- When the accumulator is discharged to approx. one third of its charge state, the maximum power is automatically reduced incrementally (80 %, 70 %, 60 % etc.) to prolong accumulator cell life. The device begins using the emergency reserve of the accumulator box after the warning symbol appears on the upper left-hand side of the display, the accumulator symbol starts flashing and the remaining operating time is shown as "0:00". The estimated remaining operating time in emergency mode is approx. 5 minutes, with a continual reduction in power until the motor has stopped. Always take into account the limited power when timing your return to the shore or boat.
- In most instances, the general personal liability insurance of the user does not cover property damage caused by the use of SEABOB. Before using the SEABOB you are encouraged to contact your insurance provider for information on a suitable insurance policy for coverage in cases involving damage.

1.3 Safety information for diving to a depth of up to 2.5 m

In addition to the safety information provided above, be sure to observe the following information when diving to a depth of up to 2.5 m:



- Only skilled and experienced swimmers should be allowed to use the SEABOB for diving to a depth of up to 2.5 m.
- Only use the SEABOB for diving if you are completely healthy. Consult a doctor if you are in doubt.
- Never dive alone.
- Be aware that it is very difficult to judge the distance of objects under water. For better visibility, wear diving goggles.
- Before diving, always check to make sure that the depth sensor is working properly. If the depth sensor is damaged or the water inlets are dirty, the motor's safety cut-off will not function at the set maximum diving depth (default setting 2.5 m). When the SEABOB is switched on, the depth sensor is automatically reset to "0.0 m". For this reason, you should switch on the SEABOB only when the craft is close to or at the same level of the surface of the water.
- Maintain a safe distance (minimum 5 m) to other persons and objects. Never attempt to dive under other swimmers, watercraft or through underwater objects. Before resurfacing, ensure that there are no swimmers, watercraft or objects above you or approaching you. Danger of collision!
- Respect the environment. Maintain a safe distance to the bottom of the sea or lake, so that sediment or aquatic plants are not kicked up and damaged by the jet of water coming from the craft or get into the jet channel. Steer clear of rocky bottoms, reefs and stones, which can lead to injury.
- Always keep an eye on the remaining operating time shown on the display, and make sure you resurface in time. Leave enough operating time so that you can get back, and make sure that you start making your way back to the accompanying boat or shore in time.
- When calculating the time it will take you to return, be sure to take into account the limited power of the craft in emergency mode.

1.4 Safety information for diving to a depth of more than 2.5 m

In addition to the safety information provided above, be sure to observe the following information when diving to a depth of more than 2.5 m:



- Only divers with a valid diving licence or accompanied by a certified diving instructor are allowed to use SEABOB for diving to a depth of more than 2.5 m.
- Only use the SEABOB for diving if you are completely healthy. Consult a doctor if you are in doubt.
- Never dive alone. Especially when scuba diving in caves, make sure that you are accompanied by another person with a second craft.
- Use only complete and fully functional diving equipment when diving. Ensure that no air apparatus components or hoses are hanging free in the water where they might get into the jet channel.
- Only dive when the visibility under water is good. Never dive without diving goggles. Only with diving goggles will you be able to detect underwater hazards in time.
- Before diving, always check to make sure that the depth sensor is working properly. If the depth sensor is damaged or the water inlets are dirty, the motor's safety cut-off will not function at the set maximum diving depth (default setting 2.5 m). The depth sensor reading in the display should be approx. "0.0 m" when the craft is on the water surface. You can double-check the reading by briefly submerging the SEABOB without activating the motor.
- The motor cuts off automatically if the set maximum diving depth (depth limit) is exceeded and can only be switched back on when the craft has returned to a diving depth that is above the depth limit.
- For safety reasons, the factory-set depth limit of 2.5 m can only be changed by first entering your Owner-PIN. This is done to prevent the setting of the maximum diving depth from being changed by unauthorised persons. After you have finished scuba diving to a depth of more than 2.5 m, reset the maximum diving depth immediately to the default safety setting of 2.5 m to prevent the risk of injury to others.
- For safety reasons, the depth limit is automatically reset to the default setting of 2.5 m each time the SEABOB is switched on.
- Keep in mind that the SEABOB switches off automatically (Sleep mode) if inactive for an extended period of more than 10 minutes (Time-off). After switching the SEABOB back on, you will need to re-enter your Owner-PIN if you want to start the motor at a diving depth of more than approx. 2.5 m. After entering your Owner-PIN, you can increase the depth limit again so that the set maximum diving depth is greater than the one currently shown. The diving depth display and the warning symbol will start flashing as soon as you exceed the depth limit.

- When scuba diving, never rely completely on the depth sensor reading. The depth sensor is provided for information purposes only. The depth sensor is not a calibrated gauge and should not be used to perform tasks such as calculating decompression times.
- Always keep an eye on the remaining operating time shown on the display. When the accumulator is discharged to approx. one third of its charge state, the maximum power is automatically reduced incrementally (80 %, 70 %, 60 % etc.) to prolong accumulator cell life. The device begins using the emergency reserve of the accumulator box after the warning symbol appears on the upper left-hand side of the display, the accumulator symbol starts flashing and the remaining operating time is shown as "0:00". The estimated remaining operating time in emergency mode is approx. 5 minutes, with a continual reduction in power until the motor has stopped. Always take into account the limited power when timing your ascent to the surface and your return to the shore or boat.
- You must always ensure that you are able to resurface and return to the shore or boat by yourself without the assistance of the SEABOB.
- Regardless of whether you are using the SEABOB while scuba diving, you should always adhere to the recommended descent and ascent rates and maximum diving duration in line with applicable diving association guidelines. Always check the display showing the remaining operating time of the SEABOB. For your own safety, however, we urge you to avoid relying solely on the craft's equipment. Never use the depth sensor to calculate descent or ascent rates. For the most part, crucial safety functions of the craft have been integrated in such a way that they are redundant. Even so, unexpected failure of these functions is still possible.

1.5 Safety information concerning the accumulator box

In addition to the special safety information on the accumulator box given in Chapter 1.1, be sure to observe the following safety information:



- Never expose the SEABOB or accumulator box to high temperatures (max. 60 °C / 140 °F) caused e.g. by open fire, direct sunlight or by storage inside a closed motor vehicle or boot. If exposed to heat, flaming gases can be discharged through the accumulator cells' safety valve causing serious injury.
- Never transport a fully charged accumulator box by aircraft or over long distances. The accumulator box should only be partially charged during transport (charge state "air transport / storage"). Only switch off the SEABOB for transport when the aircraft symbol is displayed (see Chapter 5.13 "Air transport / transport of the SEABOB and accumulator box ACS"). If instructions are disregarded, flaming gases can be discharged through the safety valve causing serious injury!
- For use under normal conditions, the chemicals contained in each High-Energy Li-Ion accumulator cell are encased in a sealed case for safe storage in any position. In addition, the individual cells are enclosed in the watertight aluminium profile of the accumulator box, which can withstand pressures up to 12 bar and helps to dissipate heat. Due to this protection, there is a risk of flaming gases being discharged only if the accumulator cells have been subjected to excessive mechanical stresses or heat.
- Only use chargers supplied by the SEABOB manufacturer to charge the accumulator box. Chargers supplied by other manufacturers are not equipped with the special microprocessor-controlled charge management system for protection of the High-Energy Li-Ion accumulator cells. As a result, flaming gases may be discharged when charging the accumulator cells with other chargers, causing serious injury.
- Beware of the strong line currents that are present when charging, in particular on the optional quick charger. Never use the charger if the mains cable is damaged or does not have a sufficient current rating (the cable must be approved for currents of at least 10 A). Doing so can cause the cable to catch fire and may lead to electric shock resulting in severe injury or death.
- Never open the accumulator box. Never attempt to alter or modify the accumulator box in any way. Doing so may cause flaming gases to be discharged through the accumulator cells' safety valve causing serious injury.
- Repairs and maintenance work on the SEABOB, accumulator box and charger that go beyond the procedures described in Chapter 6 "Care" and Chapter 7 "Troubleshooting" may only be carried out by an authorised technician. Work of this type is dangerous and may result in severe injury or cause damage to the

SEABOB, accumulator box and charger if not carried out by an authorised technician. Take precautions to avoid electric shock, and beware of flaming gases that may be discharged.

- Ensure that there are no dried salt deposits on the contacts of the charging socket or charging plug (see Chapter 6 "Care"). Salt deposits can inhibit the flow of electricity during charging and cause electrical contacts to overheat, resulting in irreparable damage to the contacts or even fires affecting the contacts or cable.
- While charging, do not place any objects on the accumulator box or charger to ensure that heat created during the charging process is dissipated properly. Ensure that air can circulate freely.
- Carry out charging in a place in the shade that is dry, cool and well ventilated. Ensure that the device is sufficiently protected from the sun. If the accumulator box is hot, let it cool down before charging.
- Caution! The charger and charging plug can get hot while charging. Let the charger and charging plug cool down before you attempt to touch them.
- Electrical outlets in some countries may not be equipped with a ground wire connection or, if they are, it may provide only insufficient protection. If this is the case, you will feel the presence of a leaking current (sometimes more, sometimes less) when you touch the charger and / or the charging plug, especially if you are wet and barefoot. For this reason, you should always disconnect the mains plug from the mains before you touch the charger or charging plug after charging.
- Before storing the device, be sure to read the safety information provided in this Operation Manual on temporary and long-term storage, especially over the winter (see Chapter 5.12 "Storing the SEABOB and accumulator box ACS"). Store the accumulator box in a place that is cool, dry, well ventilated and frostproof, and ensure that the accumulator cells are protected from irreparable total discharge.
- Before transporting the device, in particular before transporting by aircraft, be sure to read the safety information on the transport of the Lithium-Ion accumulator cells used in the accumulator box of the SEABOB (see Chapter 5.13 "Air transport / transport of the SEABOB and accumulator box ACS").
- When transporting Li-Ion accumulators, always observe the applicable safety regulations and the specific regulations of the carrier. Be aware that safety regulations can change from time to time. For up-to-date information, please contact the manufacturer or your specialist dealer.
- Never discard the accumulator box or accumulator cells as household waste or into a fire or water.

1.6 Safety information concerning the SEABOB CAYAGO F7 model



- In order to fully utilise the performance potential of the SEABOB CAYAGO F7, the use of the optionally available pilot belt system is recommended. This ensures comfortable driving, even at high power. Before using the pilot belt system, it is important that you read the "Information Sheet for Pilot Belt System".
- The securing device below the display is used exclusively for the attachment of the optionally available pilot belt system. It is not suitable for the lifting of the SEABOB. Therefore, under no circumstances use this eyelet for lifting the SEABOB using a crane or any other lifting device. The securing device could be pulled out of the SEABOB housing during lifting. In this case, the SEABOB could drop off and be damaged. Furthermore, this could prove to be dangerous for any persons in close proximity. Risk of injury!
- Use the securing device only for the pilot belt system developed by the SEABOB manufacturer. Under no circumstances attach other objects or fixtures, such as ropes or belts, to the eyelet. Risk of injury!

2. Proper use

The SEABOB is a water-sports craft powered by an electric jet drive. The craft is not equipped with navigational lights and is designed to carry one person both on and below the surface of the water. The craft is intended for use in water that is at least 1 m deep. The SEABOB is highly resistant to seawater and suitable for use in both fresh water and salt water. The device is constructed solely of materials that are non-rusting and highly resistant to corrosion. The following regulations apply to operation of the SEABOB:

2.1 Operation on the water surface

- Users of the craft must be at least 16 years old and good swimmers. People who cannot swim are not allowed to use the SEABOB.
- Minors 16 and over may only operate the SEABOB under the supervision and responsibility of an adult.
- The SEABOB is not designed for use as a swimming aid. Users may lose the craft in the water. The SEABOB is not a substitute for a life jacket, air pad or other such device. For this reason, you should wear a life jacket when away from the shore or boat.
- The SEABOB has a maximum output of 5.2 kW / 7 HP. The present law in some countries does not require registration papers or a driving licence for operation of watercraft having this output. Some countries, however, may have different licence regulations, age limits or operating restrictions. Before operating the craft, always inquire about the local regulations which may be in force in the area where you wish to operate the SEABOB. We urge all SEABOB operators to inform themselves about the situation in the country in which they will be using the SEABOB. The manufacturer does not assume any responsibility for obtaining such information.
- The SEABOB should only be used in sheltered waters. Sheltered waters are defined as sheltered coastal waters, small bays, small lakes, rivers and canals when conditions up to, and including, wind force 4 and significant wave heights up to, and including, 0,3 m may be experienced, with occasional waves of 0,5 m maximum height, for example from passing vessels.
- Do not use the SEABOB in areas occupied by swimmers or divers.
- Generally, the SEABOB can be operated in areas where the use of watercraft powered by combustion engines is not permitted. Use of the SEABOB is not permitted wherever the use of watercraft or electric-powered watercraft is prohibited by local laws, community regulations, nature conservation laws

- or other provisions. You are urged to observe all local laws and regulations. For more information, you should inquire at the appropriate local offices.
- Take your time to learn how to use the SEABOB properly. Only attempt difficult manoeuvres like full-speed operation and diving after you have mastered basic manoeuvres such as braking / stopping in the water and steering by shifting your weight / legs. Limit your speed so that you are in complete control of the SEABOB at all times. Use the SEABOB responsibly, showing consideration for people, animals, plants and the environment.
 - Only operate the SEABOB when a person you know is in visible range and has agreed to constantly keep an eye on you while you operate the craft. Arrange to have a boat accompany you if you wish to operate the craft farther away from shore. Doing so ensures that there is always someone nearby who can assist you in the event of an emergency.
 - Stay away from aquatic plants and floating objects such as pieces of string, rope, plastic or wood to prevent the motor, impeller, stator and jet channel from being damaged or their function inhibited. Avoid getting too close to the shore, rocky bottoms, reefs and stones.
 - Do not operate the SEABOB in water that is less than 1 m deep. Prevent sand or stones from getting into the jet channel. Sand or stones in the jet channel may damage the device.
 - Only let other people use your SEABOB if they are aged 16 or over and have shown you adequate proof of age (such as a valid ID) and after you have given them complete and full instructions on how to operate the SEABOB.
 - Only use the two carrying handles on either side of the craft to carry the SEABOB. Never carry the craft by the Controlgrips or display panel.
 - Never run the motor out of the water for longer than approx. 10 seconds. The seals of the motor and the hard-coated motor shaft are designed exclusively for use in the water. Operation out of the water can cause overheating due to the lack of water to cool the device, thereby causing irreparable damage to the seals and motor shaft.
 - When charging the accumulator box, always follow the instructions contained in this Operation Manual (see Chapter 5.2 "Charging the accumulator box").

2.2 Diving

In addition to the regulations specified in Chapter 2.1, the following regulations apply to diving:

- The SEABOB can be used by experienced swimmers and snorkelers for diving to a depth of up to 2.5 m.
- Only divers with a diving licence or accompanied by a certified diving instructor should be allowed to use SEABOB for diving to a depth of more than 2.5 m.
- The maximum diving depth (depth limit) of all SEABOB models is factory set to 2.5 m. Users can increase the depth limit to a maximum diving depth of 40 m (see Chapter 5.8.1 "Setting the maximum diving depth").
- When you have finished scuba diving, return to the surface in a controlled ascent. Always keep an eye on the remaining operating time shown in the display, and take this time into account when timing (see Chapter 5.6.2 "Accumulator charge state and emergency reserve"). The remaining operating time shown on the display should be used only as an approximate reference. For safety reasons, you should always include a sufficient reserve in your calculations. For your safety, it must be ensured that you can at all times, of your own strength and without the SEABOB, resurface in a controlled fashion and return to the starting point.
- When scuba diving in caves, always ensure that you are accompanied by another person with a second craft. It is important to ensure that there are always multiple alternatives for exiting the cave should one alternative fail.

3. Included in delivery

The following standard equipment is included in delivery of the SEABOB:

1. SEABOB RAVEJET and SEABOB JET 4.12 models with integrated accumulator box
2. SEABOB CAYAGO VX2 and SEABOB CAYAGO F7 models with installed accumulator box ACS

The Accumulator Change System (ACS) makes it possible to change the accumulator box. High-current contacts equipped with a special seal system are used to create the connection to the motor's electronic system.

3. A charger for charging the device for operation and air transport / storage (in particular storage over the winter)

Note: Special microprocessor-controlled quick chargers are available as an optional accessory on all SEABOB models. Quick chargers can be used to charge the accumulator box more quickly (high charging rate for shorter charging times).

4. Operation Manual, including:
 - "Quick Reference for SEABOB"
 - "Data Sheet for Charger"
5. SEABOB certificate with serial numbers and Owner-PIN

Check to make sure that all components have been included in delivery.

Also, please check that the serial numbers on the SEABOB and accumulator box match the numbers shown on your SEABOB certificate. To view the serial numbers, use the menu provided on the display (see Chapter 5.4.11 "Displaying serial numbers").

STOP The accumulator box is delivered in a partially charged state. To avoid total discharge of the accumulator box, you should charge the accumulator box immediately after delivery (within 1 week) to at least the charge state "air transport / storage". Use only the charger supplied by the SEABOB manufacturer or the optionally available quick charger to charge the accumulator box.

STOP Charge the accumulator box after each use (within 24 hours) and during longer periods of storage continuously (trickle-charge) to at least the charge state "air transport / storage" to avoid irreparable total discharge of the valuable High-Energy Li-Ion accumulator cells. Be sure to read the information provided in this Operation Manual on charging the accumulator box.

4. Description of the device

4.1 SEABOB housing (SEABOB RAVEJET and SEABOB JET 4.12 models)

Note: On SEABOB RAVEJET and SEABOB JET 4.12 models, the accumulator box is attached permanently to the SEABOB housing and cannot be changed.

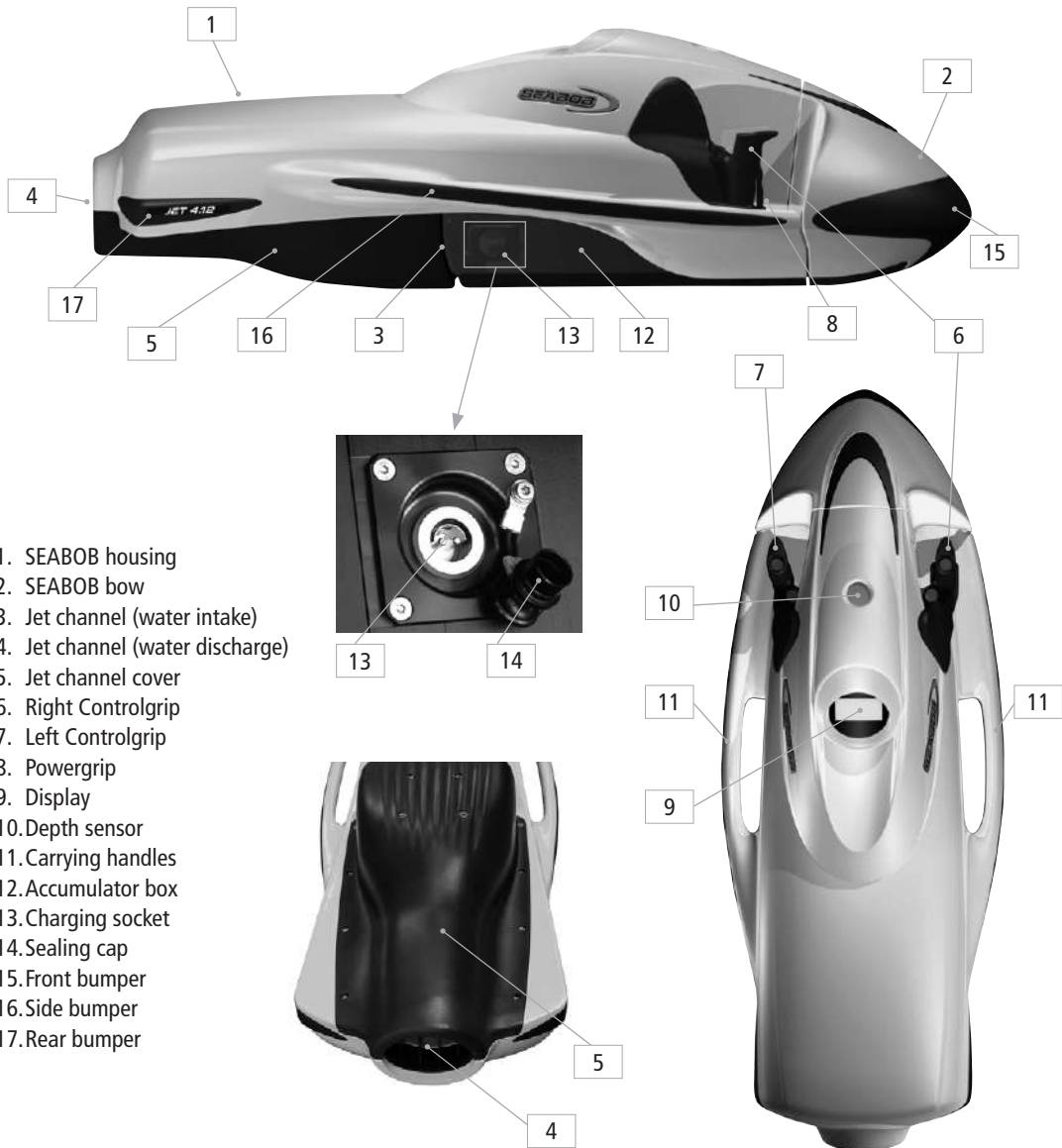

1. SEABOB housing
2. SEABOB bow
3. Jet channel (water intake)
4. Jet channel (water discharge)
5. Jet channel cover
6. Right Controlgrip
7. Left Controlgrip
8. Powergrip
9. Display
10. Depth sensor
11. Carrying handles
12. Accumulator box
13. Charging socket
14. Sealing cap
15. Front bumper
16. Side bumper
17. Rear bumper

4.2 SEABOB ACS housing (SEABOB CAYAGO VX2 and SEABOB CAYAGO F7 models) ACS

Note: On the SEABOB CAYAGO VX2 and SEABOB CAYAGO F7 models with Accumulator Change System (ACS) the accumulator box ACS can be detached from the SEABOB housing and changed.



4.3 Accumulator box ACS (ACS = Accumulator Change System) ACS

1. Accumulator box ACS
2. SEABOB bow
3. Front bumper
4. Attachment bolts
5. High-current contact plate (connecting plate)
6. Quick locking system
7. Sealing frame
8. Charging socket
9. Sealing cap

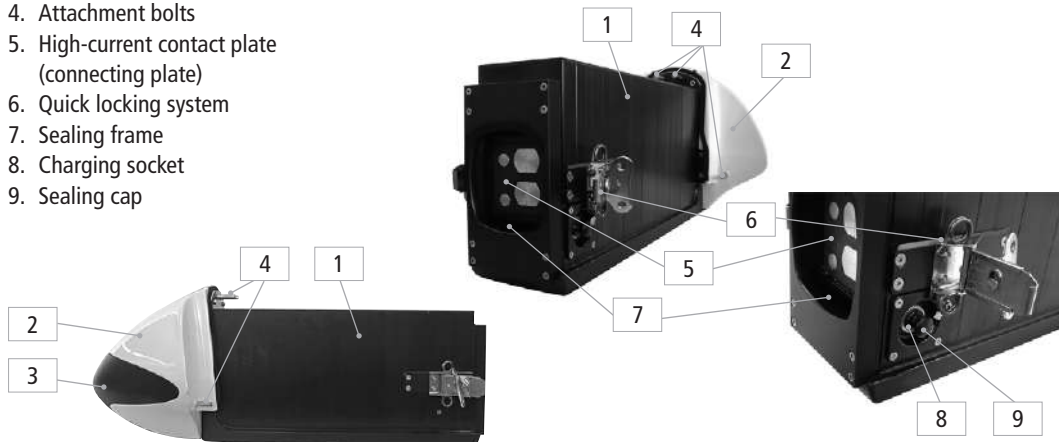

4.4 Right Controlgrip

1. Powergrip
2. Green button
3. Silver* button

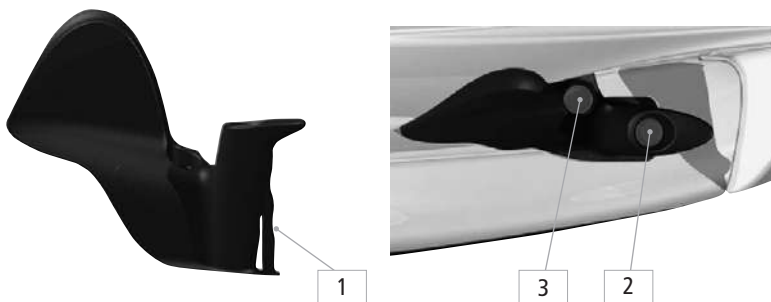

* or black

4.5 Left Controlgrip

1. Red button
2. Blue button

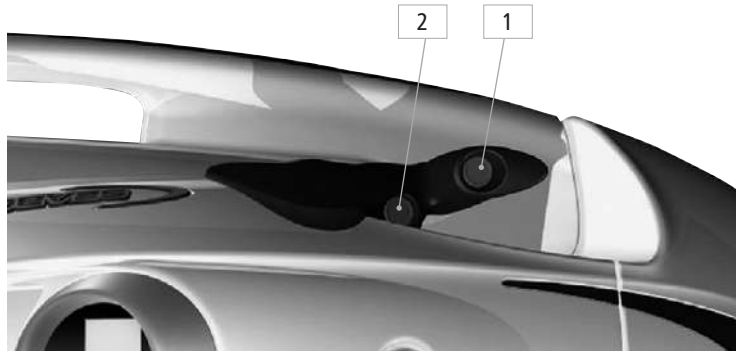

4.6 Drive unit

1. Protective lamellas (front)
2. Electronics box
3. Motor
4. Impeller wheel with impeller blades
5. Stator
6. Protective lamellas (back)

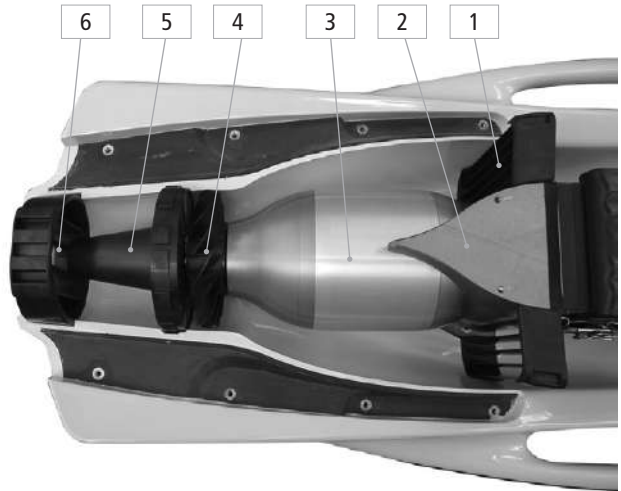

5. Operation

5.1 Start-up

 Before using the SEABOB for the first time, read through this Operation Manual carefully, including the safety information and the instructions on proper use.

 Only use the SEABOB as intended (see Chapter 2 "Proper use").

Take the SEABOB, the separate accumulator box ACS, if ordered and the charger out of the packaging, and place them on a dry and sturdy surface that will not damage the components.

Do not throw away the packaging. It can be used later (for example, when sending the device in for service).

 The accumulator box is delivered in a partially charged state. To avoid total discharge of the accumulator box, you should charge the accumulator box immediately after delivery (within 1 week) to at least the charge state "air transport / storage". Use only the charger supplied by the SEABOB manufacturer or the optionally available quick charger to charge the accumulator box.

 Charge the accumulator box after each use (within 24 hours) and during longer periods of storage continuously (trickle-charge) to at least the charge state "air transport / storage" to avoid irreparable total discharge of the valuable High-Energy Li-Ion accumulator cells. Be sure to read the information provided in this Operation Manual on charging the accumulator box.

5.2 Charging the accumulator box

 Never expose the SEABOB, accumulator box and charger to high temperatures (max. 60 °C / 140 °F) caused e.g. by open fire, direct sunlight or by storage inside a closed motor vehicle or boot. If exposed to heat, flaming gases can be discharged through the accumulator cells' safety valve causing serious injury. In addition, the LCD display will turn black if exposed to heat and may become irreparably damaged.

 Protect the charger, in particular the charging plug with sealing cap and mains plug as well as the charging socket of the accumulator box from damage, dirt, dust, moisture and heat. Beware! Danger of electric shock!

Note: The accumulator box ACS (Accumulator Change System) can be charged separately or after it has already been attached to the SEABOB. The LED display on the charger shows the activity of the charger. The exact charge state is shown on the SEABOB display. For information on how to install the accumulator box ACS see Chapter 5.3 "Installing the accumulator box ACS".

 Charge only in dry, cool and well ventilated locations. Never use the charger if any cables or plugs are damaged. Doing so can cause electric shock, resulting in severe injury or death.

 Only use chargers supplied by the SEABOB manufacturer to charge the accumulator box.

During the charging process, do not place any objects on the accumulator box or charger to ensure that heat produced during charging is dissipated properly (convection cooling). Ensure that air can circulate freely, and position the optionally available quick charger so that it is upright for optimum cooling. Should the charger (or quick charger) overheat, it automatically reduces the output current to prevent thermal overload. If this happens, the charging process is prolonged accordingly. If the accumulator box is hot, let it cool down before charging.

To charge the accumulator box, proceed as follows:

1. Place the SEABOB and accumulator box on a sturdy and dry surface that will not damage the components.
2. Dry the area around the charging socket using a soft, clean cloth.
3. Remove the sealing cap from the charging socket, and check that the inside of the charging socket is perfectly clean and dry.
4. Remove the sealing cap from the charging plug, and check that the charging plug is clean and dry. Never attempt to remove the sealing cap by twisting or pulling on the charging cable. Always hold on to the locking ring of the charging plug when removing the sealing cap.

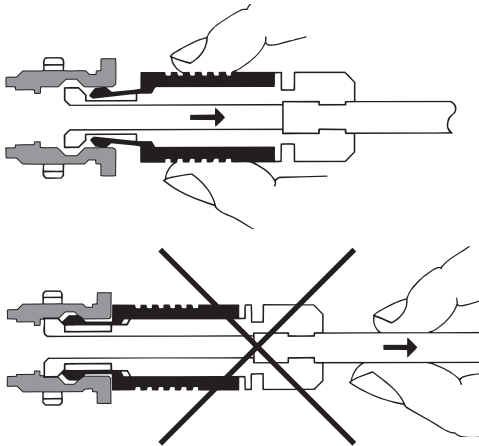

5. Ensure that the charging plug of the charger is positioned correctly (the red dot on the charging plug should be pointing to the bow of the SEABOB) before plugging it into the charging socket of the accumulator box.

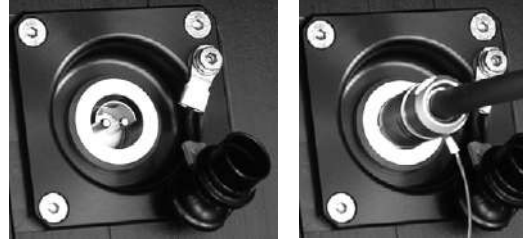

6. Only after this has been done should you plug the mains plug of the charger into the mains socket.

STOP Follow the technical specifications of the charger, particularly with regards to the correct input voltage (see "Data Sheet for Charger" and "Instructions for Use of the Quick Charger").

! If using the charger in other countries only use travel plugs which are approved for currents of at least 10 A.

7. The charge display will appear in the SEABOB's display after 15 seconds (system check). The device is now in Charge mode. Select the desired charging process. For partial charging (for air transport / storage), tap the green button on the right Controlgrip. A partially filled charge symbol will appear in the upper left-hand part of the display with an arrow to indicate partial charging. For full charging (for operation), tap the red button on the left Controlgrip. A completely filled charge symbol will appear with an arrow to indicate full charging.

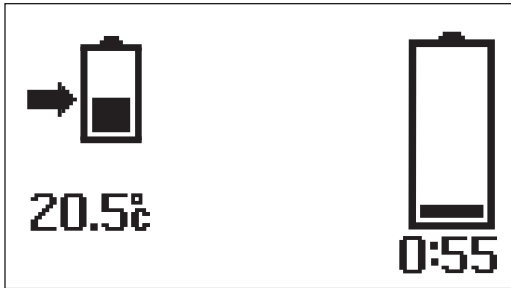

Starting partial charging for air transport / storage



Starting full charging for operation of the craft

8. Charging is performed automatically. The charge state of the accumulator box is shown by the accumulator symbol on the right side of the SEABOB display. As the charge state increases, more bars appear in the accumulator symbol. The estimated remaining charging time is displayed under the accumulator symbol.

Note: An increase in the accumulator temperature (shown on display) during charging is normal. The temperature is monitored electronically. If the accumulator overheats, the accumulator management system temporarily stops the charging process.

9. On models with the Accumulator Change System (ACS), you can view the charge state when the accumulator box ACS is attached to the SEABOB during the charging process. The charge state and the estimated remaining charging time are shown in the SEABOB's display only. The charger is only equipped with an LED showing which operation is being performed (see "Data Sheet for Charger" and "Instructions for Use of the Quick Charger").

10. However, the visual display is not needed for charging. The accumulator box ACS can be charged without actually being attached to the SEABOB. When this is done, charging is performed according to the last charging command that was given. The accumulator box is either partially charged for air transport / storage or fully charged for operation, depending on whether the green button (air transport / storage) or red button (operation) was tapped on the Control-grips when charging was last programmed.

Note: Regardless of its charge state, the accumulator box ACS can be attached to the SEABOB ACS.

Charging of the accumulator box is automatically controlled by the electronic system of the charger and the microprocessor-controlled accumulator management system, which is integrated in the accumulator box. The nature of the electronics makes it impossible to overcharge the accumulator box. The Li-Ion accumulator cells of the accumulator box do not have a memory effect. This makes it possible to charge the accumulator box regardless of its charge state and without having to discharge it beforehand. The internal voltage level of each Li-Ion accumulator cell is monitored electronically. Differences between the cells are compensated for and balanced (Cell-Balance).

STOP Charge an accumulator box which is discharged / run to empty immediately after use (within 24 hours) and during longer periods of storage continuously (trickle-charge) to avoid total discharge, which may cause irreparable chemical damage to the valuable High-Energy Li-Ion accumulator cells. Charge to at least the charge state "air transport / storage". Do not interrupt charging before this charge state has been reached.

Note: You can interrupt charging while fully charging the accumulator box, as long as the minimum charge state "air transport / storage" has been reached. When this is done, however, the power of the craft is reduced due to the lower accumulator charge state.

11. An aircraft symbol will appear on the upper left-hand part of the display when either the correct charge state for air transport or the minimum charge state for storage has been reached. When all bars are present in the accumulator symbol, the accumulator box is fully charged for operation. In both cases, the remaining charging time will be displayed as "0:00".



Partial charging for air transport / storage complete



Full charging for operation of the craft complete

12. To complete the charging process, first pull the mains plug from the mains socket. Never attempt to remove the mains plug by twisting or pulling on the mains cable. Always hold on to the mains plug.
13. Only after this has been done should you disconnect the charging plug (which is no longer carrying electricity) from the charging socket of the accumulator box. Never attempt to remove the charging plug by twisting or pulling on the charging cable. Always hold on to the locking ring of the charging plug (see figure on page 28).

STOP To complete the charging process, first pull the mains plug from the mains socket. Only then should you disconnect the charging plug from the charging socket. Danger of short circuit!

! Caution! The charger and charging plug can get hot while charging. After you have finished charging, let the charger and charging plug cool down before you touch them.

14. Reinsert the dry and clean sealing cap securely into the charging socket of the accumulator box.

15. Place the dry and clean sealing cap securely on the charging plug of the charger.



16. After the charger has been disconnected, the SEABOB performs a 1-minute system check and then switches off to Off mode if programmed to partial charging (see Chapter 5.4.5 "Off mode") or to Sleep mode if programmed to full charging (see Chapter 5.4.6 "Sleep mode").

Note: If the temperature of the accumulator box exceeds 60 °C / 140 °F, the accumulator management system deactivates all functions of the accumulator box. After this has been done, operation is no longer possible. Allow the accumulator box some time to cool down in the shade.

! Never put the accumulator box ACS (Accumulator Change System) separately into water to cool it off.

To cool off the accumulator box ACS more quickly, attach it correctly to the SEABOB and place the SEABOB together with the installed accumulator box properly

into the water. On models with the Accumulator Change System (ACS), ensure that the accumulator box ACS has been attached securely to the SEABOB housing so that no water can leak in.

Always ensure that the sealing cap has been placed securely on the charging socket.

 Never plug the charging plug into a moist or wet charging socket for charging.

The charging socket is hermetically sealed to prevent water from leaking into the accumulator box. Water, in particular salt water, on the contacts of the charging socket or charging plug may result in strong chemical reactions while charging, causing irreparable damage to the charging socket contacts and the charging plug.

For this reason, you should always check to make sure that the charging socket and charging plug are perfectly clean and dry before plugging the charging plug into the charging socket of the accumulator box. Always put the sealing caps back on the charging socket and charging plug immediately after charging is completed. Only open the charging socket and charging plug for the charging process.

Before charging, always dry the charging socket and charging plug using a soft, clean cloth and / or cotton swab, and blow the water out of the contacts. If necessary, first rinse off any salt deposits with clear water.

 Before rinsing off components, ensure that the mains plug has been disconnected from the mains socket. Not doing so may result in electric shock!

Using auxiliary power units / electric generators:

 Only electric generators with precise closed-loop control suitable for connection to electronic devices are permissible. Asynchronous generators are not suitable and can result in destruction of the chargers. Furthermore, there is danger of injury in the event of destruction. Use of electric generators with inverter technology is preferred. The continuous power of the generator must be greater than the input power of the charger (see rating plate).

5.3 Installing the accumulator box ACS (Accumulator Change System)

Note: The following description applies only to the SEABOB CAYAGO VX2 and SEABOB CAYAGO F7 models with Accumulator Change System (ACS). These are the only models on which the accumulator box ACS can be detached from the SEABOB housing and changed.

1. Place the accumulator box ACS on a dry and sturdy surface that will not damage any components.

 Prevent the sealing surfaces and contact surfaces on the SEABOB ACS and accumulator box ACS from getting dirty, particularly from blowing dust or sand. Do not place the accumulator box on surfaces covered with grass or similar. When connecting the accumulator box and SEABOB housing, blades of grass may get in between the sealing surfaces, reducing the effectiveness of the seal.

Each time prior to activation of the accumulator box ACS, always check the sealing surfaces and contact surfaces of the SEABOB and accumulator box. If necessary, clean the surfaces using a clean, damp, lint-free cloth.

 Prevent the high-current contact plate of the accumulator box and the high-current connector plate of the SEABOB from coming into direct contact with water. These components are not sealed to protect them from sprayed or pressurised water. Protection from sprayed or pressurised water is provided solely by the quad ring and spacer O-ring (sealing rings) on the electronic system of the SEABOB motor, and only if the accumulator box ACS has been securely connected to the SEABOB and the SEABOB is ready for operation. Water leaking into the motor's electronic system or the accumulator box may cause complete destruction of the electronic system and motor or lead to discharge of flaming gases from the accumulator cells, causing injury.

2. At the latest after changing the accumulator ten times, you should wipe off the sealing surfaces and contact surfaces on the high-current connecting plates of the accumulator box ACS and SEABOB ACS using a soft, clean, lint-free cloth, so that they are clean and dry. At

the latest after changing the accumulator ten times, you should also spray the sealing surfaces and contact surfaces with Klüber Kontasynth BA 100 special lubricant. Perfectly clean, scratch-free and moistened, the sealing frame of the accumulator box should fit smoothly over the quad ring, which should also be perfectly clean, scratch-free and moistened.

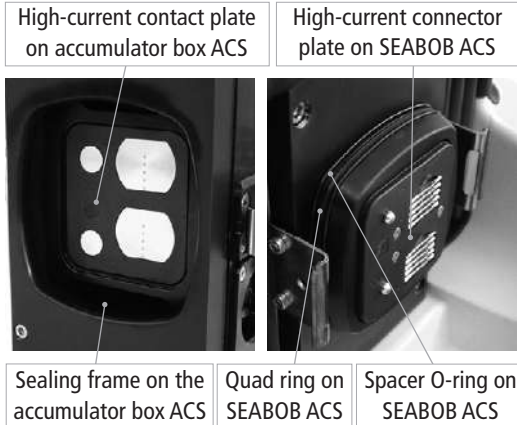

STOP Ensure that the contacts between the SEABOB housing and the accumulator box ACS are always kept perfectly clean and dry. Only use Klüber Kontasynth BA 100 special lubricant to ensure that the electrical conductivity of the high-current contacts is not diminished and that no chemical reactions are triggered which could corrode the sealing rings, thereby reducing the effectiveness of the seal.

STOP Caution! Dirty and / or damaged seals can reduce the effectiveness of the seal.

Ensure that the seals on the SEABOB and the sealing frame on the accumulator box ACS are clean, free of scratches and scoring and undamaged. Check this additionally if necessary by taking your finger (your finger should be clean) and feeling around the sealing surface of the sealing frame and quad ring. Use only the special lubricant specified above to spray and preserve the seals.

3. Lower the SEABOB housing onto the accumulator box ACS at a distance of approx. 10 cm from the craft's bow.

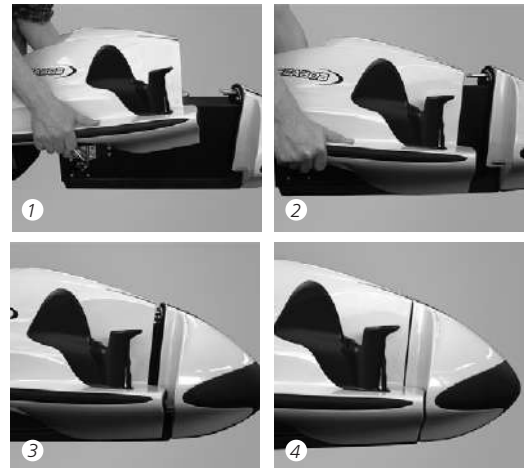

4. Slide the SEABOB housing forward, moving it over the accumulator box until the attachment bolts near the bow are seated correctly in the attachment holes of the housing and the high-current connector plate

of the SEABOB has been inserted into the sealing frame of the accumulator box. When there is about one centimetre left to go, press the accumulator box and the SEABOB firmly together to overcome the light pressure that has built up within the seal system. If you have difficulty pushing the components together, spray the clean sealing ring and frame with the special lubricant specified above.

STOP When connecting the accumulator box and SEABOB housing, make sure that no blades of grass, dirt, dust or sand can get caught between the seals, thereby reducing the effectiveness of the seal.

5. Insert the quick clamps of the accumulator box into the locking hooks on the SEABOB housing.

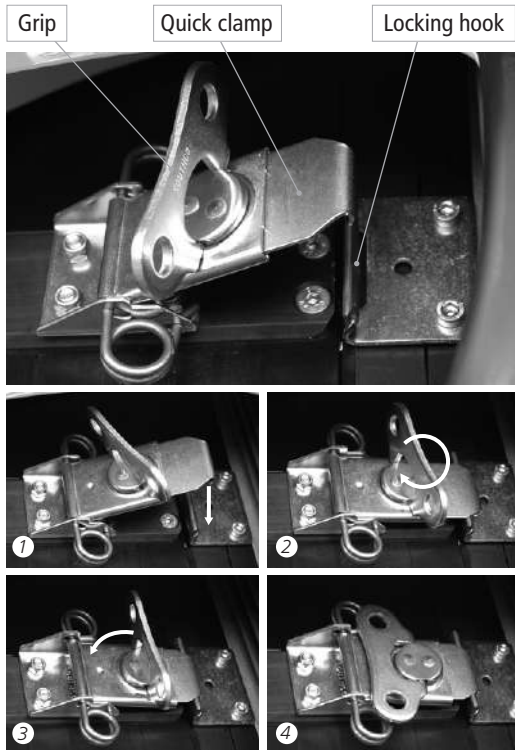

6. Turn the grips of the quick clamps clockwise until tight.
7. Fold the grips of the quick clamps down toward the bow of the craft so that the grips lie flat against the housing.

⚠ Caution! Beware of sharp edges on the locking clamps. For technical reasons, sharp edges created during manufacture may be present on the locking clamps. Sharp edges may cause minor injuries to fingers, fingernails and other body parts, especially if you are not used to using the locking clamps.

8. Double-check the sealing cap on the charging socket to ensure that it is seated properly.
9. The SEABOB is now ready for operation once the accumulator box has been fully charged.

5.4 Operating the SEABOB



Never run the motor out of the water for longer than approx. 10 seconds. The seals of the motor and the hard-coated motor shaft are designed exclusively for use in the water. Operation out of the water leads to overheating due to the lack of water to cool the device, thereby causing irreparable damage to the seals and motor shaft.

5.4.1 Controls and display panel

1. Green button = plus button
2. Red button = minus button
3. Silver* button = select button
4. Blue button = select button
5. Powergrip = motor enable (on / off), power control, confirm button
6. Graphic LCD display, black / white display with adjustable background brightness and contrast setting

* or black

5.4.2 Arrangement of the controls



1. The green button is located on the top of the right Controlgrip toward the front.
2. The red button is located on the top of the left Controlgrip toward the front.
3. The silver* button is located on the base of the right Controlgrip toward the back.
4. The blue button is located on the base of the left Controlgrip toward the back.
5. The Powergrip is located on the front of the right Controlgrip.

5.4.3 Using the controls

The buttons used on the SEABOB are high-quality, watertight piezo-actuated electronic buttons that do not have mechanical parts and, for this reason, are not subject to wear (button life: over 20 million operations). These buttons are designed to react to sudden changes in pressure. For this reason, you only have to tap them lightly. Regardless of how long or hard you press the buttons, they always react by emitting a single short pulse. A pulse may also be emitted if the SEABOB falls hard to the ground or is struck hard by another object, if the SEABOB is hit hard or the buttons are inadvertently touched. For safety reasons, you have to tap the blue button and pull the Powergrip within a fixed time period to activate the switch-on function. This is done to prevent the SEABOB from being switched on inadvertently.

The Powergrip is made of seawater-resistant spring steel. It can be in a released position, pulled position or other position in between. The Powergrip is used as a confirm button and for enabling the motor (on / off). By pulling the Powergrip against the Controlgrip, you can activate the motor (the motor runs with a minimum power of 10 %). When you release the Powergrip, the motor stops immediately.

* or black

5.4.4 Display (operation display)

The graphic display is divided into three fields. During operation of the craft, the following information is shown in the main menu:

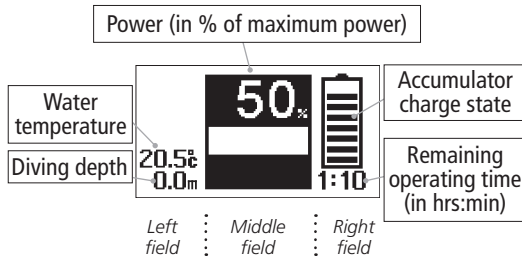

Left field:

On the top left-hand part of the display, additional symbols may appear. Below is a list of these symbols and their descriptions:



Warning symbol

- Accumulator charge state low, emergency mode (accumulator symbol flashing) → Charge accumulator box!
- Maximum diving depth exceeded (diving depth display flashing) → Motor stops
- When timer has been activated: remaining operating time is less than 25 % of the entire operating time (timer display flashing)
- Accumulator temperature warning (accumulator symbol and temperature display flashing) → Power is limited to 30 %



Stop symbol

- SEABOB not ready for operation
- Accumulator discharged → Charge accumulator box!
- When timer has been activated: operating time elapsed
- Maximum accumulator temperature exceeded (accumulator symbol and temperature display flashing) → Motor stops



Workshop symbol

- Motor defect
 - Accumulator defect
 - System defect (such as water leakage in accumulator box or electronic system)
- Contact manufacturer or specialist dealer!

Charge symbols (in charge display)



- Partial charging to accumulator charge state for air transport / storage



- Full charging to full accumulator charge state for operation



Aircraft symbol (in charge display)

- Charge state for air transport / storage reached



Sun symbol (in "settings" menu)

- Mode for setting the display brightness

The current water temperature (in °C) is shown under the optionally displayed symbols.

Below, the current diving depth (in m) is displayed.

Note: If you activate the Timer to limit the operating time, the remaining operating time (in hrs:min) is displayed instead of the water temperature (Timer is activated via the menu using the Owner-PIN; Timer is activated at an operating time > "0:00").

Middle field:

- Bar graphic with a large, easy-to-read number display at the top showing the set power (power display)



- Setting can be made in 10 % increments (10 power levels).
- Power can be changed by tapping the green button (+10 %) or red button (-10 %).

Right field:

- Accumulator symbol with bars indicating the accumulator charge state
- Remaining operating time (in hrs:min) is displayed under the symbol.

5.4.5 Off mode (air transport / storage) – switching on / off

Special safety precautions must be taken before transporting the craft, particularly by aircraft. The current flowing to the accumulator must be cut off, and precautions must be taken to ensure that the device cannot be switched on inadvertently or incorrectly. For safety reasons, the SEABOB cannot be switched back on when it is in Off mode by tapping the device's buttons. It can only be switched on using a connected and active charger. When the SEABOB is in Sleep mode, however, it can be switched back on using the device's buttons.

Switching off to Off mode:

Switching off to Off mode can only be done using a connected and active charger. To switch off to Off mode, proceed as follows, taking into account the information contained in Chapter 5.2 "Charging the accumulator box":

1. Plug the charging plug into the charging socket on the accumulator box.
2. Plug the mains plug into the mains socket.
3. The charge display will appear in the display after 15 seconds (system check).
4. Tap the green button for partial charging of the accumulator box to the charge state "air transport / storage" (a partially filled charge symbol will appear in the display).
5. When the aircraft symbol appears in the display, the charge state for air transport / storage has been reached.
6. If you disconnect the charger from the charging socket, the SEABOB / accumulator box ACS will switch off to Off mode after 1 minute (system check), regardless of the current charge state and even if the correct charge state for air transport / storage has not been reached.

For this reason, you should follow the instructions given in Chapter 5.12 "Storing the SEABOB and accumulator box ACS" and Chapter 5.13 "Air transport / transport of the SEABOB and accumulator box ACS" on correctly switching off the device to Off mode for air transport and storage.

Note: If the accumulator charge state is too high prior to starting the partial charging process for air transport / transport, you will have to perform a discharge by running the accumulator box to empty in a controlled fashion as described in Chapter 5.13.

Switching on from Off mode:

When the system is in Off mode, it can only be switched back on by initiating the charging process.

1. Plug the charging plug into the charging socket on the accumulator box.
2. Plug the mains plug into the mains socket.
3. Activation of the SEABOB is triggered by the independent electronic control system in the accumulator box together with a correctly detected charger (system check).
4. The charge display will appear in the display after 15 seconds. The SEABOB is now in Charge mode.
5. Decide how to proceed using the green or red button (see Chapter 5.4.9 "Charge mode" and Chapter 5.4.10 "Charge display").

5.4.6 Sleep mode – switching on / off

In Sleep mode, the display and motor are switched off.

Switching on from Sleep mode:

Note: If the Powergrip is not activated within 3 seconds after tapping the blue button during activation, the display will switch off again (device reverts to Sleep mode).

1. Tap the blue button.
2. The display is switched on, and the SEABOB logo appears.
3. Pull the Powergrip against the Controlgrip (within 3 seconds). Hold it there until the software version number under the SEABOB logo in the display disappears after 1 second (this step is for calibration of the on / off position of the Powergrip; Teach-in).
4. Release the Powergrip completely.
5. The User-PIN or Owner-PIN prompt will appear in the display (if activated). If the PIN prompt has been deactivated, the operation display will appear directly.
6. The display illumination will switch off (Stand-by mode) if the user does not activate a button or the Powergrip within 1 minute.

Note: The PIN prompt when switching on the device can be activated using the optional software available on CD.

Automatic switching off to Sleep mode (Time-off):

If the user does not activate one of the four buttons or the Powergrip within 1 minute, the system will first switch to Stand-by mode (display illumination is switched off). If no actions are performed by the user within the next 10 minutes (Time-off), the SEABOB logo will appear. After another 15 seconds, the system will switch off automatically to Sleep mode.

Manual switching off to Sleep mode:

You can also switch the SEABOB to Sleep mode manually. To do so, proceed as follows:

1. The operation display is shown in the display.
2. Tap the button combination silver*– blue in quick sequence. The SEABOB logo will appear in the display.
3. If the user does not activate a button or the Powergrip within 15 seconds, the system will switch to Sleep mode and switch off.

5.4.7 Stand-by mode

In this mode, the display and control panel are active and ready for a command from the user. The display illumination is switched off. No current is flowing to the motor.

If the user activates a button or the Powergrip, the system switches to On mode and the display illumination switches on. If the user does not perform any actions within 1 minute, the display illumination switches off again (device reverts to Stand-by mode). After another 10 minutes have elapsed without any action by the user (Time-off), the system reverts automatically to Sleep mode.

* or black

5.4.8 On mode

The display illumination is switched on. The motor is switched on by pulling the Powergrip (the motor runs with a minimum power of 10 %). If the user does not activate a button or the Powergrip within 1 minute, the system first switches to Stand-by mode. After another 10 minutes have elapsed without any action by the user (Time-off), the system reverts automatically to Sleep mode.

5.4.9 Charge mode

The charger is connected to the device and is supplying the charging voltage. Before charging begins, an accumulator / charge diagnostic check (system check) is performed. Charging is activated once the diagnostic check has been completed successfully. It is not possible to switch on the motor. After 15 seconds, the charge display showing the accumulator symbol will appear in the display (see Chapter 5.4.10 "Charge display").

The system can only be switched from another mode to Charge mode using a connected and active charger.

Note: If the charger is disconnected from the device, thereby interrupting the charging voltage, the SEABOB switches off after 1 minute (system check) and switches to Off mode (if programmed to partial charging) or to Sleep mode (if programmed to full charging).

5.4.10 Charge display

After the charger is connected to the accumulator box and then to a power source, the system / accumulator box first performs a system check and then automatically switches to Charge mode. After 15 seconds, the charge display appears. It is not possible to switch on the motor.

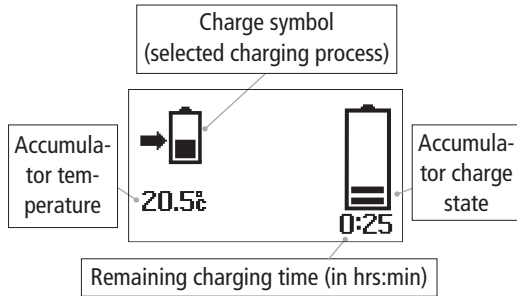

1. The charge state is shown by individual bars in the accumulator symbol on the right-hand side of the display. The number of bars indicates the charge state. When all bars are shown in the accumulator symbol, the accumulator box is fully charged.
2. The estimated remaining charging time (in hrs:min) is displayed under the accumulator symbol.
3. Tap the green button to select partial charging of the accumulator box for air transport / storage. A partially filled charge symbol will appear in the upper left-hand part of the display with an arrow to indicate partial charging.
4. Tap the red button to select full charging of the accumulator box for operation. A completely filled charge symbol will appear in the upper left-hand part of the display with an arrow to indicate full charging.
5. If programmed to partial charging for air transport / storage, an aircraft symbol will appear when the correct partial charge state has been reached. A remaining charging time of "0:00" is displayed.

6. If programmed to full charging, all bars are displayed in the accumulator symbol and the remaining charging time is shown as "0:00", the accumulator box is fully charged and the SEABOB is ready for operation.
7. If, when programmed to partial charging, the charger is disconnected from the device when the aircraft symbol is displayed, the system switches to Off mode after 1 minute (system check) and switches off for transport, in particular air transport, or storage.
8. If the charger is disconnected from the device when programmed to full charging and the accumulator box is fully charged, the system switches off to Sleep mode and is ready for operation.

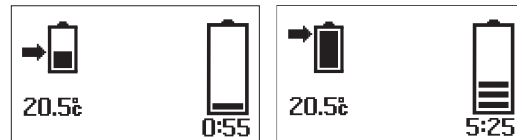

Starting partial charging for air transport / storage

Starting full charging for operation



Partial charging for air transport / storage complete

Full charging for operation complete

5.4.11 Displaying serial numbers



SEABOB serial number

Accumulator box serial number

1. The SEABOB is in Sleep mode. The display is switched off.
2. Tap the blue button.
3. The display is switched on, and the SEABOB logo appears.
4. Pull the Powergrip against the Controlgrip (within 3 seconds), and hold it there continuously.
5. The software version number under the SEABOB logo disappears after 1 second.
6. Hold the Powergrip in pulled position. Tap the green button. The serial number of the SEABOB is displayed (the first letter is an "S").
7. Hold the Powergrip in pulled position. Tap the red button. The serial number of the accumulator box is displayed (the first letter is an "A").

5.4.12 Entering PIN (Owner-PIN / User-PIN)

Owner-PIN:

This PIN (Personal Identification Number) of the owner is used to change the settings in the menu or to switch on the device (if PIN prompt has been activated).

User-PIN:

This PIN (Personal Identification Number) of the user is used to switch on the device (if PIN prompt has been activated).

Note: Please find your Owner-PIN on the supplied certificate.

The PIN prompt when switching on the device is deactivated at the factory. This means that you will be able to switch the SEABOB on without entering a PIN. If you want to activate the PIN prompt when switching on the device, or if you want to activate and change the User-PIN, you will need the optional software available on CD (see Chapter 11 "Accessories").

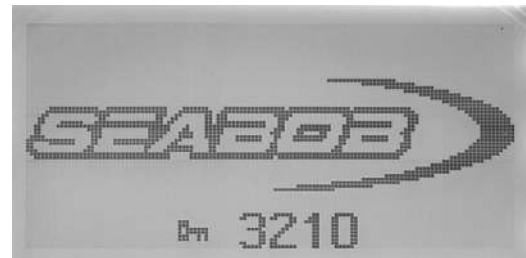

Entering PIN

If the PIN prompt has been activated (PIN \neq "0000"), the user will be required to enter the PIN when switching on the device. To switch on the SEABOB, you can use either the Owner-PIN or the User-PIN. Since you are the SEABOB owner, you can use either PIN, so that you only have to remember one number. The owner of the craft provides the user only with the User-PIN for switching on the SEABOB. The Owner-PIN is the only PIN that can be used for safety settings, in particular the maximum diving depth, maximum power and operating time limit (Timer).

To enter the PIN, you must use the four buttons and confirm your entry with the Powergrip:

1. Tap the red button (repeatedly) to change the first digit of the PIN.
2. Tap the blue button (repeatedly) to change the second digit of the PIN.
3. Tap the silver* button (repeatedly) to change the third digit of the PIN.
4. Tap the green button (repeatedly) to change the fourth digit of the PIN.
5. Pull the Powergrip against the Controlgrip. Entry of the PIN is confirmed, and the system checks to make sure the PIN is correct.
6. If the PIN is invalid, the display is reset to "0000" and the PIN must be entered once again.

Note: If a valid PIN is not entered within 30 seconds, the system reverts to Sleep mode.

5.4.13 Settings

1. The system is in Stand-by mode or On mode. The operation display is shown in the display.
2. Tap the button combination silver*– blue – red in quick sequence. The Owner-PIN prompt will appear.
3. Enter your Owner-PIN and confirm your entry by pulling the Powergrip (see Chapter 5.4.12 "Entering PIN"). The setting for the operating time limit (Timer) appears.
4. Switch between the settings (Timer for limiting the operating time, maximum diving depth, maximum power, display brightness) with the blue or silver* button and select the setting you want.
5. Enter the desired value. To increase the displayed value, tap the green button (repeatedly). To decrease the displayed value, tap the red button (repeatedly).
6. Pull the Powergrip to confirm the new settings and return to the operation display.

Note: If you do not want to limit the operating time, leave the Timer deactivated (setting: operating time = "0:00"). If the Timer has been activated, the SEABOB switches to the greatly reduced emergency mode immediately after the operating time has elapsed, regardless of the remaining accumulator charge state.

* or black

5.4.14 Operation

1. Switch on the SEABOB. The operation display appears in the display.
2. To increase the power, tap the green button (repeatedly). The power display increases in increments of 10 % with every tap of the green button (10 power levels).
3. To reduce the power, tap the red button (repeatedly). The power display decreases in increments of 10 % with every tap of the red button (10 power levels).
4. Pull the Powergrip against the Controlgrip and hold it there. The motor starts, and the SEABOB begins moving. A minimum power of 10 % is required for starting.
5. The power can also be adjusted during operation.
6. To stop, hold on to both Controlgrips securely, and release the Powergrip in your right hand. The SEABOB stops.

When the accumulator is discharged to approx. one third of its charge state, the motor's electronic control system reduces the maximum power incrementally (80 %, 70 %, 60 % etc.). This is done to prolong accumulator cell life as the voltage decreases, while ensuring that there is sufficient reserve capacity for emergency mode. The device begins using the emergency reserve of the accumulator box after the warning symbol appears on the upper left-hand side of the display, the accumulator symbol starts flashing and the remaining operating time is shown as "0:00". In emergency mode, the power is gradually reduced automatically until the motor comes to a complete stop. The estimated remaining operating time in emergency mode is approx. 5 minutes, with a continual reduction in power.

 Charge the accumulator box after each use (within 24 hours) to at least the charge state "air transport / storage" to avoid irreparable total discharge of the valuable Li-Ion accumulator cells.

5.4.15 IrDA (infrared interface)

The system uses a built-in IrDA interface to communicate with another IrDA device (such as a notebook or PDA). The built-in IrDA transceiver is located in the centre, directly above the LCD display. It has a range of at least 25 cm (perpendicular to the display).



This infrared interface (IrDA) is used together with the optional software available on CD and an external PC (such as a notebook) to activate the PIN prompt when switching on the device or to activate / change the User-PIN (see Chapter 5.4.12 "Entering PIN"). The infrared interface can also be used by the manufacturer or specialist dealer for performing diagnostic checks.

5.5 Before starting

Switch on the SEABOB.

We recommend that you switch on the SEABOB and perform a brief function check before you place the craft in the water. To do this, proceed as follows:

1. Tap the blue button.
2. The display is switched on, and the SEABOB logo appears.
3. Pull the Powergrip against the Controlgrip (within 3 seconds), and hold it there for at least 1 second.
4. The software version number under the SEABOB logo disappears after 1 second.
5. Release the Powergrip completely.
6. The User-PIN or Owner-PIN prompt will appear (if activated). If the PIN prompt has been deactivated, the operation display will appear directly.

Note: The PIN prompt when switching on the device can be activated using the optional software available on CD.

7. The stop symbol on the top left-hand side of the display will flash for approx. 6 seconds. After the stop symbol disappears, the self check is complete and the motor's electronic system is activated.
8. The power is displayed as "0 %" in the power display. Tap the green button on the right Controlgrip once. When you tap the button, the power shown on the display increases to the next higher power level ("10 %").
9. Together with another person, lift the SEABOB by the carrying handles on each side, and place it in water that is at least 1 m deep. You can also move the SEABOB using the SEABOB-Cart (optionally available accessory).



Never carry the SEABOB by the Controlgrips, front bumper or display panel but only by the carrying handles on each side.

10. The SEABOB is now ready for operation.



If you are launching the SEABOB from a boat, always have another person help you put the SEABOB in the water and take it out (in particular, in waves). Ensure that no one is under the SEABOB. Danger of injury!

5.6 Operation on the water surface

⚠ Both before and during operation, observe the safety information given in Chapter 1 as well as those listed below:

- The water must be at least 1 m deep. Operating the craft in water that is less than 1 m deep may cause injury to you or damage to the SEABOB as a result of hitting underwater objects (particularly if there are rocky bottoms, reefs and stones).
- Make sure that there are no aquatic plants or floating objects in the water that could get into the jet channel and damage or jam the motor or impeller.
- Maintain a safe distance (minimum 5 m) to other persons, watercrafts and obstacles. Danger of collision and injury!
- Do not operate the SEABOB in strong currents, a heavy swell, strong wind or impaired visibility.
- Only operate the craft when it is light out and the weather is good. Always check the weather forecast before you set out, and pay close attention to local weather conditions.

5.6.1 How to navigate your SEABOB

1. Lie down on the SEABOB facing forward. Stretch your arms out completely, and grab on to the Controlgrips firmly.



2. Use the green and red buttons to select the desired power in %. To increase the power, tap the green button (repeatedly). To decrease the power, tap the red button (repeatedly). The power display increases or decreases in increments of 10 % (10 power levels).
3. Pull the Powergrip against the Controlgrip, and hold it there. The motor starts, and the SEABOB begins moving.



Powergrip on right Controlgrip



Pulling the Powergrip against the Controlgrip

4. If you want to go faster, use your right thumb to tap the green button on the right Controlgrip. You can also perform this operation while the craft is moving. The power increases in increments of 10 % with every tap of the button (10 power levels) until the maximum power of 100 % is reached.



- If you want to go more slowly, use your left thumb to tap the red button on the left Controlgrip. You can also perform this operation while the craft is moving. The power decreases in increments of 10 % with every tap of the button.

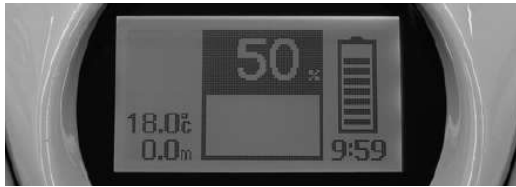



- A minimum power of 10 % is required to start moving from a complete stop or to keep moving during operation.
- To turn, shift your weight in the direction you want to go, while pulling the bow of the craft in the same direction. Lean into the curve, just as you would on a bicycle or motorcycle. The lower part of your body, in particular your legs, act as a tail fin. While turning the craft, hold on to the Controlgrips tightly, so that you do not slide off the SEABOB.

 Practise turning the craft at low speeds until you are able to control the SEABOB with ease. Danger of collision and injury!

- To stop, continue holding on to both Controlgrips securely, and release the Powergrip in your right hand. The motor will stop, and the resistance of the water will quickly slow you down. Be aware that it can take around 2-3 m for you to come to a complete stop if you are travelling at full speed, depending on your momentum and speed up to that point. You can reduce the distance it takes you to come to a complete

stop by turning the SEABOB sharply to the side and straightening up without letting go of the craft. This helps you to maintain control of the SEABOB and increases the water resistance considerably, so that you can come to a complete stop as quickly as possible.

 The SEABOB brakes by cutting off the power and allowing the water resistance to slow the craft. It can take around 2-3 m for you to come to a complete stop, depending on the speed you are travelling. For this reason, always maintain a safe distance (minimum 5 m) to other persons, watercrafts and obstacles. Danger of collision and injury!

 If the SEABOB is released while travelling at full speed, the craft may continue moving up to approx. 3 m and may briefly dive under the water to a depth of up to approx. 2 m. When this occurs, there is the risk that persons may be injured and foreign objects may be damaged. Also the SEABOB may be damaged, particularly if the water is too shallow and the craft hits the bottom.

5.6.2 Accumulator charge state and emergency reserve

 Always keep an eye on the charge state of the accumulator box. Always take into account the amount of time required to return to your starting point. Ensure that you start making your way back to the starting point, shore or accompanying boat in time.

The charge state of the accumulator box is constantly shown by the accumulator symbol on the right side of the display. As the charge level decreases, the bars on the accumulator symbol begin to disappear one by one from the top (100 %) to the bottom (0 %).

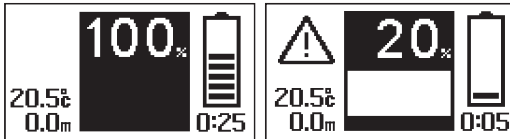

*Display during operation
(100 % power)*

*Emergency mode with
warning symbol*

The remaining operating time (in hrs:min) is displayed simultaneously under the accumulator symbol. The remaining operating time is calculated by the microprocessor and depends on the current charge state and amount of power consumed. Thus, the remaining operating time is shorter when the power is high and longer when the power is low.

When the accumulator is discharged to approx. one third of its charge state, the motor's electronic control system reduces the maximum power incrementally (80 %, 70 %, 60 % etc.). This is done to prolong accumulator cell life as the voltage decreases, while ensuring that there is sufficient reserve capacity for emergency mode. The device begins using the emergency reserve of the accumulator box after the warning symbol appears on the upper left-hand side of the display, the accumulator symbol starts flashing and the remaining operating time is shown as "0:00". In emergency mode, the power is gradually reduced automatically until the motor comes to a complete stop. The estimated remaining operating time in emergency mode is approx. 5 minutes, with a continual reduction in power.



Always take into account the limited power of the craft when timing your return to the shore or boat.

5.7 Diving to a depth of 2.5 m

⚠ In addition to the safety information and instructions relating to operation on the water surface, be sure to observe the following safety information when diving:

- Only skilled and experienced swimmers are allowed to use the SEABOB for diving to a depth of up to 2.5 m.
- Only use the SEABOB for diving if you are completely healthy. Consult a doctor if you are in doubt.
- Never dive alone.
- Before diving, always check to make sure that the depth sensor is working properly.
- Maintain a safe distance from other objects and the bottom of the sea or lake, particularly if there are rocky bottoms, reefs and stones.
- Maintain a safe distance (minimum 5 m) to other persons and objects. Never dive under other swimmers, watercraft or through underwater objects. Beware of collisions!
- Be aware that it is very difficult to judge the distance of objects under water. For better visibility, wear diving goggles.
- Always keep an eye on the remaining operating time shown on the display, and make sure you resurface in time. When calculating the time it will take you to return, be sure to take into account the limited power of the craft in emergency mode.



How to dive with your SEABOB

5.7.1 How to dive with your SEABOB

1. Increase the power to approx. 50 %.
2. Bend your arms while pulling yourself closer to the front of the SEABOB.
3. Push the SEABOB down, so that the bow of the craft goes down into the water. The speed of the SEABOB allows the craft to overcome its own buoyancy and dive into the water.
4. After the craft is submerged, you can adjust the power to the level you want.
5. To resurface, straighten out your arms and pull back on the Controlgrips, so that the bow of the SEABOB moves upward. The higher your speed is, the easier it is to turn the craft, since your body acts as a rudder in the water.

⚠ Before resurfacing, ensure that there are no swimmers, watercraft or objects above you. Beware of collisions that may cause injury to you or other people.

If the factory-set maximum diving depth of approx. 2.5 m is exceeded, the motor switches off automatically. The buoyancy of the SEABOB causes the craft to resurface by itself. The buoyancy of the SEABOB varies from model to model. When the craft has returned to a diving depth that is above the depth limit of approx. 2.5 m, you can resume operating the craft at the set power.

⚠ Never stick sharp objects into the depth sensor or do anything else that could damage the depth sensor. Prevent all dirt, sand, polish or other material from getting into the water inlets on the depth sensor. A damaged depth sensor or dirty inlets can impair operation of the device, even leading to complete failure. Always rinse out the depth sensor thoroughly with fresh water to prevent the build-up of salt deposits. Use a garden hose or similar equipment for cleaning. Never use a high-pressure hose or steam jet. If the depth sensor is damaged or the inlets are dirty, the motor's safety cut-off will not function at the set maximum diving depth (default setting 2.5 m). This may damage the health of the user.

5.8 Diving to a depth of more than 2.5 m

 **Be sure to read the safety information and instructions relating to operation on the water surface and diving to a depth of up to 2.5 m. In addition, observe the following safety information:**

- Only divers with a valid diving licence or accompanied by a certified diving instructor are allowed to use the SEABOB for diving to a depth of more than 2.5 m.
- Only use the SEABOB for diving if you are completely healthy. Consult a doctor if you are in doubt.
- Use only complete and fully functional diving equipment, in particular diving goggles, when diving.
- Never dive alone. Especially when scuba diving in caves, make sure that you are accompanied by another person with a second craft.
- Before diving, always check to make sure that the depth sensor is working properly.
- Always adhere to the recommended descent and ascent rates for scuba diving, while observing the decompression times.
- Always keep an eye on the remaining operating time and include reserves in your calculations. Always ensure that you are able to resurface and return to the starting point by yourself without the assistance of the SEABOB.
- When scuba diving, never rely completely on the depth sensor reading. The depth sensor is provided for information purposes only. The depth sensor is not a calibrated gauge and should not be used to perform tasks such as calculating decompression times.

5.8.1 Setting the maximum diving depth

The diving depth limit for all SEABOB models is factory set to 2.5 m (depth limit with safety cut-off). If you want to dive to greater depths, you can increase the diving depth incrementally up to the maximum diving depth. The maximum possible diving depth is 40 m.

 Only divers with an appropriate diving licence are allowed to increase the maximum diving depth of 2.5 m with the purpose of diving to a greater programmable depth.

To set the maximum diving depth, proceed as follows:

1. Switch on the SEABOB (the device should be ready for operation). The operation display appears in the display.
2. Tap the button combination silver*– blue – red in quick sequence.
3. Enter your Owner-PIN (see Chapter 5.4.12 "Entering PIN").
4. Switch between the settings with the blue or silver* button until the maximum diving depth is displayed.
5. To increase the maximum diving depth, tap the green button (repeatedly).
6. To decrease the maximum diving depth, tap the red button (repeatedly).
7. Pull the Powergrip against the Controlgrip to confirm the new setting and return to the operation display.

 For safety reasons, the factory-set depth limit of 2.5 m can only be changed by first entering your Owner-PIN. This is done to prevent the setting of the maximum diving depth from being changed by unauthorised persons. After you have finished scuba diving to a depth of more than 2.5 m, reset the maximum diving depth immediately to the default safety setting of 2.5 m to prevent the risk of injury to others.

For safety reasons, the depth limit is automatically reset to the default setting of 2.5 m each time the SEABOB is switched on.

* or black

Keep in mind that the SEABOB switches off automatically (Sleep mode) if inactive for a period of more than 10 minutes (Time-off). After switching the SEABOB back on, you will need to re-enter your Owner-PIN if you want to start the motor at a diving depth of more than approx. 2.5 m. After entering your Owner-PIN, you can increase the depth limit again so that the set maximum diving depth is greater than the one currently shown. The diving depth display and the warning symbol will start flashing as soon as you exceed the depth limit.

5.8.2 Adjusting the buoyancy of the SEABOB

Note: Before adjusting the buoyancy, be sure to read the "Information Sheet for Buoyancy Adjustment Weights" supplied with the optionally available weights.



Be sure to observe the safety information given in the "Information Sheet for Buoyancy Adjustment Weights".

The buoyancy of the SEABOB varies depending on the model (see Chapter 8 "Technical specifications") and whether the craft is operated in fresh water or salt water (the buoyancy changes with the salt content of the water). The buoyancy of the SEABOB can be adjusted using optionally available weights.

The benefit of the SEABOB's buoyancy: when the SEABOB is switched off and not fitted with additional weights, it will always float on the surface of the water or resurface if submerged.

The SEABOB RAVEJET model has a relatively high buoyancy and is particularly well suited to operation mainly on the water surface. The craft can be adjusted by the optionally available weights depending on the designated use and the salt content of the water.

The SEABOB JET 4.12, SEABOB CAYAGO VX2 and SEABOB CAYAGO F7 models with their lower buoyancy are particularly well suited to scuba diving. They can be adjusted by a relatively small amount of additional weights depending on the designated use and the salt content of the water.

5.9 After use

1. Together with one other person, hold on to the carrying handles on both sides, and lift the SEABOB out of the water, placing the SEABOB on a dry and sturdy surface that will not damage any components.



Never carry the SEABOB by the Controlgrips or display panel.



Moor the SEABOB safely if you decide leave it in the water for a short time. Ensure that the SEABOB cannot become unattached, injure others or obstruct their path.

2. Switch off the SEABOB to prevent further discharging (switch device to Sleep mode by tapping the button combination silver*– blue in quick sequence and waiting for 15 seconds). This also prevents unauthorised persons, inexperienced persons or children from using the SEABOB and injuring themselves.



Never leave the SEABOB unattended to prevent children or other inexperienced or unauthorised persons from using the device.

3. Do not leave the SEABOB in the sun if it is not being used. Without water to cool the device, the direct sunlight can heat the display to temperatures of around 70 °C / 158 °F. If exposed to such heat, the LCD display will turn black and can no longer be read. This may cause irreparable damage to the display. For this reason, you should always put the SEABOB in the shade when not in use or, if necessary, cover the display with a wet, light-coloured towel to prevent irreparable damage to the display caused by excessive heat, particularly as a result of being in direct sunlight.



Never expose the SEABOB, the accumulator box and the charger to high temperatures (max. 60 °C / 140 °F) caused e.g. by open fire, direct sunlight or by storage inside a closed motor vehicle or boot. If exposed to heat, flaming gases can be discharged through the accumulator cells' safety valve causing serious injury. In addition, the LCD display will turn black if exposed to heat and may become irreparably damaged.

* or black

4. After detaching the accumulator box ACS from the SEABOB, prevent the sealing surfaces and contact surfaces on the SEABOB and accumulator box from getting dirty, particularly from blowing dust or sand.



Never detach or remove the accumulator box ACS from the SEABOB ACS while the device is still in the water. If this occurs, a short circuit may result, causing irreparable damage to the SEABOB's electronic system. Water, especially salt water, is highly conductive of electricity. As a result, water seeping into the accumulator box may cause flaming gases to be discharged through the accumulator cells' safety valve causing serious injury.

5. Charge the accumulator box after each use (within 24 hours) to at least the charge state "air transport / storage" to prevent total discharge of the accumulator box. Be sure to read the information provided in this Operation Manual on charging the accumulator box.

5.10 Switching off the SEABOB to Sleep mode

Manual switching off to Sleep mode:

1. The operation display is shown in the display.
2. Tap the button combination silver*– blue in quick sequence. The SEABOB logo will appear in the display.
3. Wait 15 seconds. If the user does not activate a button or the Powergrip within this time, the SEABOB will automatically switch off to Sleep mode.

Automatic switch-off (Time-off):

If the user does not activate a button or the Powergrip within 1 minute, the SEABOB switches off the display illumination (Stand-by mode) after the time has elapsed (Time-off). As soon as the user performs an action, the display illumination switches back on, and the SEABOB is ready for operation.

After 10 minutes have elapsed without any action by the user (Time-off), the SEABOB logo appears on the display. After another 15 seconds, the SEABOB switches off automatically to Sleep mode.

To switch the device back on from Sleep mode, see Chapter 5.4.6 "Sleep mode".

Note: When the accumulator box is completely discharged / run to empty, the SEABOB and the display switch off completely (Off mode). The SEABOB can only be switched on from Off mode using a connected and active charger.

STOP Charge the accumulator box immediately (within 24 hours) to at least the charge state "air transport / storage" to avoid irreparable total discharge of the valuable Li-Ion accumulator cells.

5.11 Detaching the accumulator box ACS (Accumulator Change System)

See also Chapter 5.3 "Installing the accumulator box ACS".

Note: The following description applies only to the SEABOB CAYAGO VX2 and SEABOB CAYAGO F7 models with Accumulator Change System (ACS). These are the only models on which the accumulator box ACS can be detached from the SEABOB and changed.

1. Place the SEABOB ACS and accumulator box ACS on a dry and sturdy surface that will not damage the components.
2. Fold the grips of the quick clamps upward, and turn them anticlockwise until they are fully open.
3. Pull the quick clamps applied to the accumulator box away from the accumulator box.
4. Turn the grips of the quick clamps clockwise again to shorten the length of the quick clamps.



5. Fold the quick clamps back down so that they lie flat against the accumulator box. The quick clamps should be positioned so that they are flush with the locking hooks.

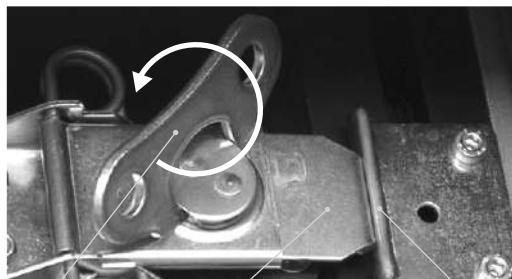

Grip

Quick clamp

Locking hook

* or black

6. Turn the grips of the quick clamps anticlockwise at the same time on both sides of the accumulator box. Doing this will push the SEABOB away from the accumulator box.



Caution! Beware of possible sharp edges on the locking clamps. For technical reasons, sharp edges created during manufacture may be present on the locking clamps. Sharp edges may cause minor injuries to fingers, fingernails and other body parts, especially if you are not used to using the locking clamps.

7. Slide the rear of the SEABOB housing backwards a maximum of approx. 10 cm until the accumulator box ACS is detached from the SEABOB housing.



Never slide the SEABOB completely backwards over the accumulator box. If this is done, the quick clamps may damage the housing in the accumulator shaft.

8. Holding on to the carrying handles on each side, lift up the SEABOB housing off the accumulator box.
9. Store the accumulator box ACS in a place that is cool, dry, well ventilated and frostproof.

Note: Without the accumulator box ACS, the SEABOB ACS is fully deactivated and non-functional.



Never expose the SEABOB, the accumulator box and the charger to high temperatures (max. 60 °C / 140 °F) caused e.g. by open fire, direct sunlight or by storage inside a closed motor vehicle or boot. If exposed to heat, flaming gases can be discharged through the accumulator cells' safety valve causing serious injury. In addition, the LCD display will turn black if exposed to heat and may become irreparably damaged.

5.12 Storing the SEABOB and accumulator box ACS

If you do not plan to use the SEABOB / accumulator box ACS for an extended period, the accumulator box must be stored at least in a partial charge state (charge state "air transport / storage"). The minimum charge state during storage is required to prevent irreparable total discharge of the valuable Li-Ion accumulator cells and to ensure that the microprocessor-controlled Cell-Balance function remains active. You may have to recharge the accumulator box, depending on its charge state. The charging process is controlled automatically by the charger and accumulator management system.

Be sure to read the information contained in Chapter 5.2 "Charging the accumulator box".

To prepare the device for storage, proceed as follows:

1. Place the SEABOB and accumulator box on a dry and sturdy surface that will not damage the components.
2. Ensure that the charging plug, charging socket and mains plug are perfectly clean and dry. If necessary, dry them using a soft, clean cloth.
3. Plug the charging plug of the charger into the charging socket of the accumulator box. Then plug the mains plug of the charger into the mains socket.
4. The charge display will appear on the SEABOB after 15 seconds (system check). The device is now in Charge mode.
5. Tap the green button to select partial charging of the accumulator box to charge state "air transport / storage". A partially filled charge symbol will appear on the upper left-hand side of the display with an arrow to indicate partial charging.
6. When the aircraft symbol appears on the display and the remaining charging time is displayed as "0:00", partial charging is complete and the minimum charge state for storage has been reached. You can now disconnect the charger from the accumulator box (first

pull the mains plug from the mains socket, then pull the charging plug from the charging socket of the accumulator box).

 **Caution!** The charger and charging plug can get hot while charging. After you have finished charging, let the charger and charging plug cool down before you touch them.

7. After the charger is disconnected from the accumulator box, the system switches off completely (switches to Off mode) after 1 minute (system check) if programmed to partial charging. For safety reasons relating to air transport, the system can only be switched back on from Off mode using a connected and active charger.
8. Store the SEABOB and accumulator box ACS separately from the SEABOB ACS on a stable, level surface in a place that is cool, dry, well ventilated and frostproof. The optimum storage temperature is +10 to +25 °C / +50 to +77 °F.

 High temperatures may shorten the life of the Li-Ion accumulator cells.

 When storing the device for an extended period, you should repeat the charging process after 4 weeks at the latest to maintain the minimum charge state required for storage. If this is not done, total discharge may result, causing irreparable chemical damage to the valuable High-Energy Li-Ion accumulator cells. The internal accumulator management system will not permit further charging of a totally discharged accumulator box (under 2.5 V per Li-Ion accumulator cell).

Final acoustic warning when the total discharge point is reached:

If the voltage of a Li-Ion accumulator cell falls below 3.1 V, the accumulator box emits a short signal (beeping sound) every 5 seconds. These final warning signals indicating a voltage under 3.1 V are emitted for a period lasting up to several days before the Li-Ion accumulator cells are totally discharged (voltage under 2.5 V), causing irreparable chemical damage to the cells. **Charge the accumulator box immediately!** The acoustic signals are

emitted until the cells are recharged to a voltage above 3.1 V or the accumulator cells are totally and irreparably discharged due to lack of charging.

Note: Acoustic signals may still be emitted even if the cell voltage has already fallen below 2.5 V and the accumulator management system does not permit further charging.

Note: For storage exceeding 4 weeks, in particular storage over the winter, we recommend keeping the activated charger connected continuously to the accumulator box (trickle-charge) to maintain the required charge state and prevent total discharge. Before doing this, make sure that you activate charge state "air transport / storage" in the menu (see also Chapter 5.4.10 "Charge display"). The charging process is controlled automatically by the charger and accumulator management system.

 Never expose the SEABOB, the accumulator box and the charger to high temperatures (max. 60 °C / 140 °F) caused e.g. by open fire, direct sunlight or by storage inside a closed motor vehicle or boot. If exposed to heat, flaming gases can be discharged through the accumulator cells' safety valve causing serious injury. In addition, the LCD display will turn black if exposed to heat and may become irreparably damaged.

 Protect the charger, in particular the charging plug with sealing cap and mains plug as well as the charging socket on the accumulator box from damage, dirt, dust, moisture and heat. Not doing so may result in electric shock!

5.13 Air transport / transport of the SEABOB and accumulator box ACS

 When transporting Li-Ion accumulators, always observe the applicable safety regulations and the specific regulations of the carrier. Be aware that safety regulations can change from time to time. For up-to-date information, please contact the manufacturer or your specialist dealer.

 Never transport a fully charged accumulator box by aircraft or over long distances. The accumulator box should only be partially charged during transport (charge state "air transport / storage"). Only switch off the SEABOB for transport when the aircraft symbol is displayed. If instructions are disregarded, flaming gases can be discharged through the safety valve causing serious injury.

For safety reasons, you should always charge the Li-Ion accumulator cells to the partial charge state "air transport / storage" before transporting the accumulator box over long distances, particularly by aircraft. Switch off the SEABOB completely (Off mode) (see Chapter 5.14 "Switching off the SEABOB for storage or transport").

Be sure to read the information contained in Chapter 5.2 "Charging the accumulator box".

To prepare the device for transport, in particular transport by aircraft, proceed as follows:

1. Place the SEABOB and accumulator box on a dry and sturdy surface that will not damage the components.
2. Ensure that the charging plug, charging socket and mains plug are perfectly clean and dry. If necessary, dry them off using a soft, clean cloth.
3. Plug the charging plug of the charger into the charging socket of the accumulator box. Then plug the mains plug of the charger into the mains socket.
4. The charge display will appear on the SEABOB after 15 seconds (system check). The device is now in Charge mode.
5. Tap the green button to select partial charging of the accumulator box for air transport / transport. A par-

tially filled charge symbol will appear on the upper left-hand side of the display with an arrow to indicate partial charging.

6. When the aircraft symbol appears on the display and the remaining charging time is displayed as "0:00", charging is complete and the correct charge state for air transport / transport has been reached.
7. Disconnect the charger from the accumulator box (first pull the mains plug from the mains socket, then disconnect the charging plug from the charging socket of the accumulator box).

 **Caution!** The charger and charging plug can get hot while charging. After you have finished charging, let the charger and charging plug cool down before you touch them.

Accumulator charge state is too high:

The charging process is controlled automatically by the charger and accumulator management system. If the accumulator voltage is too low, the charger automatically recharges until the correct partial charge state has been reached and then stops the charging process. You will recognise this process in the display by the first bars beginning to appear in the accumulator symbol until the aircraft symbol appears.

If the accumulator voltage is too high for extended transport / air transport (accumulator symbol and charge symbol in the display are flashing), you will have to reduce the excessive charge state for partial charging by running the accumulator box to empty in a controlled fashion. Operate the SEABOB (while in the water) until only 1 bar is left showing in the accumulator symbol in the display. Switch off the motor so that there is no load, and check the display again. After the motor is switched off, the accumulator voltage is regenerated slightly, so you should wait a few minutes before checking the display. If only 1 bar is still displayed, charge the accumulator box as specified to the charge state "air transport / storage". When the aircraft symbol appears and the remaining charging time is displayed as "0:00", the correct voltage for air transport / transport has been reached.



Never run the motor out of the water for longer than approx. 10 seconds to discharge the accumulator box. The seals of the motor and the hard-coated motor shaft are designed exclusively for use in the water. Operation out of the water leads to overheating due to the lack of water to cool the device, thereby causing irreparable damage to the seals and motor shaft.

Note: If the charger is disconnected from the device when programmed to partial charging, the SEABOB switches to Off mode after 1 minute (system check). The SEABOB can only be switched back on from Off mode using a connected and active charger.

After transporting the device, charge the accumulator box immediately (within 1 week) either for operation of the craft or for storage by means of trickle-charge (the charger remains connected; the aircraft symbol appears in the display).

When transporting Li-Ion accumulators, always observe the applicable safety regulations and the specific regulations of the carrier. Be aware that safety regulations can change from time to time. For up-to-date information, please contact the manufacturer or your specialist dealer.



Never expose the SEABOB, the accumulator box and the charger to high temperatures (max. 60 °C / 140 °F) caused e.g. by open fire, direct sunlight or by storage inside a closed motor vehicle or boot. If exposed to heat, flaming gases can be discharged through the accumulator cells' safety valve causing serious injury. In addition, the LCD display will turn black if exposed to heat and may become irreparably damaged.



Protect the charger, in particular the charging plug with sealing cap and mains plug as well as the charging socket on the accumulator box from damage, dirt, dust, moisture and heat. Not doing so may result in electric shock!

5.14 Switching off the SEABOB for storage or transport

Switch on the SEABOB (see Chapter 5.4.6 "Sleep mode"). Before completely switching off to Off mode, make sure that the correct charge state for transport or the minimum charge state required for storage (charge state "air transport / storage") is reached.

Therefore, proceed as described in Chapter 5.12 "Storing the SEABOB and accumulator box ACS" and Chapter 5.13 "Air transport / transport of the SEABOB and accumulator box ACS".

If you disconnect the charger (after partial charging to the charge state "air transport / storage"), the SEABOB will switch off completely (switch to Off mode) after 1 minute (system check), regardless of the current charge state. After this occurs, the SEABOB can only be switched back on using a connected and active charger.

Note: Always keep in mind, particularly if you plan to operate the craft, that you will need an active charger connected to the mains voltage to switch the SEABOB back on from Off mode.

6. Care

 Repairs and maintenance work on the SEABOB and accumulator box that go beyond the procedures described in this chapter may only be carried out by an authorised technician. Work of this type is dangerous and may result in severe injury or cause damage to the SEABOB and accumulator box if not carried out by an authorised technician.

 Never alter or modify any part of the SEABOB, accumulator box or charger. Doing so may result in serious injury or death.

Note: Be aware that components such as accumulators, seals, impeller blades and stator are wearing parts. Signs of wear and use may also appear on the housing, surface finish, display screen, etc.

No special maintenance is required if you adhere to the instructions for care specified below. Aside from regular cleaning and care, you only have to replace wearing parts when necessary. Nevertheless, we recommend that you have the SEABOB checked after approx. 3,000 hours of motor operation to ensure that all parts are working properly (for example, the motor sealing case). To have the SEABOB checked, please contact the manufacturer or your specialist dealer.

To care for your SEABOB, regularly perform the following:

6.1 Cleaning the SEABOB, accumulator box and charger

1. After using the device, first remove salt deposits, dirt or other foreign objects by rinsing the components with fresh water (from a low-pressure source such as a garden hose or watering can) and / or blowing them out with air from a low-pressure hose.

2. Clean the SEABOB using a soft, clean cloth. If necessary, you can also use a mild cleaning agent designed for plastic surfaces that will not damage the finish.

 Aggressive cleaning agents such as aerosol sprays, petroleum-based substances, acetone and alcohol as well as sharp objects may damage the SEABOB. Avoid scratching the display screen while cleaning the device. This polycarbonate screen is used, among other things, as a UV filter and is coated to prevent scratching. Even so, particularly sand may leave permanent scratches on the screen if rubbed against the screen.

3. Check the sealing surfaces of the charging socket and sealing cap. In particular, look for any sand or salt deposits that may be present. Immediately remove any sand or salt deposits, being particularly careful when doing so. No current is flowing to the charging socket. Rinse off the hermetically sealed charging socket and the sealing cap with fresh water (for example, using a garden hose). Avoid leaving any scratches or salt deposits on the sealing surfaces or contact surfaces. Clean and dry off sealing / contact surfaces by blowing them out or using a soft cloth and / or cotton swab.

4. The charging socket must be perfectly clean and dry before charging can begin.

5. Always ensure that the seals and sealing surfaces are clean and not damaged in any way.

 Ensure that there are no dried salt deposits on the charging plug or the contacts of the charging socket. Salt deposits inhibit the flow of electricity during charging and can cause electrical contacts to overheat, resulting in irreparable damage to the contacts or even fires affecting the contacts or cable.

On models with Accumulator Change System (SEABOB CAYAGO VX2 and SEABOB CAYAGO F7 models):

ACS

1. Clean the sealing / contact surfaces of the high-current connecting plates on the accumulator box ACS and SEABOB housing by blowing them out or using a soft cloth. In particular, look for any sand or dried salt deposits that may be present (see above). Be very careful when removing sand or salt deposits. Avoid leaving any scratches on the sealing / contact surfaces.
2. At the latest after changing the accumulator ten times, spray the sealing ring (quad ring) on the high-current connector plate of the SEABOB and the sealing frame on the accumulator box ACS with Klüber Kontasynth BA 100 special lubricant. This prevents mechanical damage to the ACS sealing mechanism and ensures long-term, smooth and easy sliding of the quad ring over the sealing surface of the sealing frame on the accumulator box.
3. Spray the sealing / contact surfaces of the high-current connecting plates only with Klüber Kontasynth BA 100 special lubricant.
4. Always ensure that the seals and sealing surfaces are clean and not scratched or damaged in any way.
5. Check the locking mechanisms of the quick clamps on the accumulator box periodically to make sure they move smoothly. If necessary, spray the locking mechanisms with the special lubricant specified above.

6.2 Changing the seals

STOP Even minute damage or dirt on the sealing cap, sealing rings and sealing surfaces can reduce the effectiveness of the seal, resulting in damage to the charging socket and charging plug as well as damage to the accumulator box, the motor and the motor's electronic system on models with the Accumulator Change System (ACS). For this reason, damaged seals (sealing cap, sealing rings and sealing frame) should be replaced immediately.

! Do not attempt to change a damaged sealing frame (on models with ACS) by yourself. Contact the manufacturer or your specialist dealer immediately.

To purchase new seals (sealing cap for charging socket and sealing rings for the Accumulator Change System) that you can replace yourself, contact the manufacturer or your specialist dealer. These components are sold as replacement parts.

To replace the sealing cap on the charging socket, proceed as follows:

1. Remove the attachment screw securing the sealing cap (M4 x 16 stainless steel cheese head screw with hex socket and low-profile head) using an Allen key (size 3).

! Never unscrew the four screws located in each of the corners around the charging socket. Doing so may cause water to seep into the accumulator box, resulting in discharge of flaming gases and causing serious injury.



Only remove the attachment screw securing the sealing cap

- Remove the sealing cap and the washers from the attachment screw.
- Slide the fixing eyelet of the new sealing cap and the washers all the way onto the M4 x 16 screw in the following order: a) the first stainless steel washer, b) the fixing eyelet of the sealing cap, c) the second stainless steel washer, d) the plastic washer.

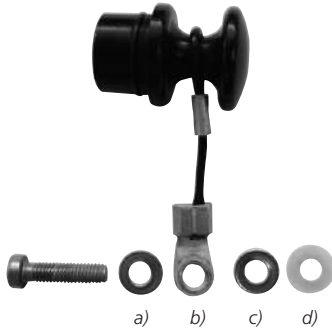

- Before screwing in the attachment screw, apply a small amount of Klüber Staburags NBU 30 PTM lubricating grease to the threads of the screw.
- Tighten the M4 x 16 attachment screw using the Allen key (size 3).
- Check that the sealing cap is seated properly, and insert the clean and dry sealing cap securely into the charging socket of the accumulator box.

On models with Accumulator Change System (SEABOB CAYAGO VX2 and SEABOB CAYAGO F7 models):

ACS

Before changing the sealing cap, you must remove the quick clamp system mounted above it. To do this, remove the four attachment screws (M5 x 10 stainless steel countersunk screws with hex socket) on the attachment plate of the quick clamp system using an Allen key (size 3). Apply a small amount of Klüber Staburags NBU 30 PTM lubricating grease to the threads of the attachment screws. After changing the sealing cap, use the Allen key to screw the attachment plate of the quick clamp system back on.

Replacing the sealing rings (quad ring or spacer O-ring) on models with Accumulator Change System (ACS):

- Use both hands to remove the damaged sealing rings. Remove the quad ring carefully from the groove without damaging it.
- Place the new quad ring carefully in the groove. Slide the spacer O-ring over the quad ring up to the rear edge to the motor's electronics.



Do not use sharp or pointed objects to remove or install the sealing rings.

- Spray the high-current contacts, the new sealing rings (quad ring and spacer O-ring) and the sealing surface of the sealing frame on the accumulator box ACS with Klüber Kontasynt BA 100 special lubricant.
- Reattach the accumulator box ACS to the SEABOB housing as described in Chapter 5.3 "Installing the accumulator box ACS".

7. Troubleshooting



Repairs and maintenance work on the SEABOB and accumulator box that go beyond the procedures described in this chapter may only be carried out by an authorised technician. Work of this type is dangerous and may result in severe injury or cause damage to the SEABOB and accumulator box if not carried out by an authorised technician.



Never alter or modify any part of the SEABOB, accumulator box or charger. Doing so may result in severe injuries or death.

Note: Be aware that components such as accumulators, seals, impeller blades and stator are wearing parts. Signs of wear and use may also appear on the housing, surface finish, display screen, etc.

7.1 SEABOB cannot be switched on

If you cannot switch on the SEABOB, either the accumulator box is completely discharged / run to empty or the SEABOB has been switched off for air transport / storage. If this is the case, you can only switch on the device using an active and connected charger (see Chapter 5.4.5 "Off mode").

7.2 Accumulator box emits an acoustic signal

Acoustic signal (beeping sound):

A beeping sound is the final acoustic warning that is emitted when the total discharge point is reached. If the voltage of a Li-Ion accumulator cell falls below 3.1 V, the accumulator box emits a short signal (beeping sound) every 5 seconds. These final warning signals indicating a voltage under 3.1 V are emitted for a period lasting up to several days before the Li-Ion accumulator cells are totally discharged (voltage under 2.5 V), causing irreparable chemical damage to the cells.

Remedy: Charge the accumulator box immediately!

Acoustic signals are emitted until the cells are recharged to a voltage above 3.1 V or the accumulator cells are totally and irreparably discharged due to lack of charging.

Note: Acoustic signals may still be emitted even if the cell voltage has already fallen below 2.5 V and the accumulator management system does not permit further charging.

Beeping sound or steady acoustic signal even though the accumulator cells are not totally discharged:

This means that water has leaked into the accumulator box!



Do **not** turn the accumulator box over! Water, particularly salt water, leaking into the accumulator box causes total discharge of the accumulator cells. This may create steam, producing excess pressure within the accumulator box.

Stop all operation immediately, including all charging. Contact the manufacturer or your specialist dealer without delay.



Never open the accumulator box. Use caution when transporting! Air transport is no longer permitted! Danger of short circuit! If instructions are disregarded, flaming gases can be discharged through the accumulator cells' safety valve causing serious injury.

7.3 Motor does not run

- Check the charge state of the accumulator box by checking to see if the SEABOB display functions. The accumulator box is discharged / run to empty when the voltage per Li-Ion accumulator cell is 2.7 V. If this is the case, the display is switched off and no longer illuminated.

Remedy: Charge the accumulator box immediately!

- Ensure that a minimum power of 10 % has been set.
- The set maximum diving depth (depth limit) may have been exceeded (diving depth display and warning symbol flashing). The motor can only be switched back on when the craft has returned to a diving depth that is above the depth limit.
- The workshop symbol is displayed: motor, accumulator or system defect. Contact the manufacturer or your specialist dealer.

On models with Accumulator Change System (SEABOB CAYAGO VX2 and SEABOB CAYAGO F7 models):

ACS

- Check that the accumulator box ACS is connected properly and securely attached to the SEABOB housing.
- Check that the high-current contact surfaces of the connecting plates on the accumulator box ACS and SEABOB are clean. If they are dirty, clean them.

7.4 Impeller does not turn (no thrust)

Check whether any foreign objects such as aquatic plants, pieces of rope or plastic wrappers have entered the jet channel of the SEABOB and damaged or jammed the impeller or stator. If this is the case, proceed as follows:

1. Switch off the SEABOB, take it out of the water and place it on a dry and sturdy surface that will not damage any components.

⚠ Never attempt to remove foreign objects while the SEABOB is in the water. Never reach in between the protective lamellas of the jet channel. Caution! Rotating parts may cause injury.

2. Always ensure that the SEABOB has been switched off completely (Off mode; accumulator box ACS detached and removed) to prevent inadvertent activation of the motor, causing injury.

Note: An active and connected charger is required to switch the device to Off mode.

3. Turn the SEABOB over so that the underside of the device is pointing upward. Ensure that the device is placed on a surface that will not scratch the SEABOB or display screen.
4. Use an Allen key (size 5) to remove the twelve attachment screws (ten M6 x 16 and two M6 x 25 stainless steel cheese head screws with hex socket) on the jet channel cover located on the underside of the SEABOB housing. After this has been done, lift off the jet channel cover.

⚠ Always switch off the SEABOB completely (Off mode; accumulator box ACS detached and removed) before lifting off the jet channel cover. Caution! The rotating impeller may cause injury.

5. Remove the foreign objects from the jet channel, stator and impeller.
6. Before screwing the screws back in, apply a small amount of Klüber Staburags NBU 30 PTM lubricating grease to the threads of the two M6 x 25 stainless steel cheese head screws that were screwed in the motor housing.

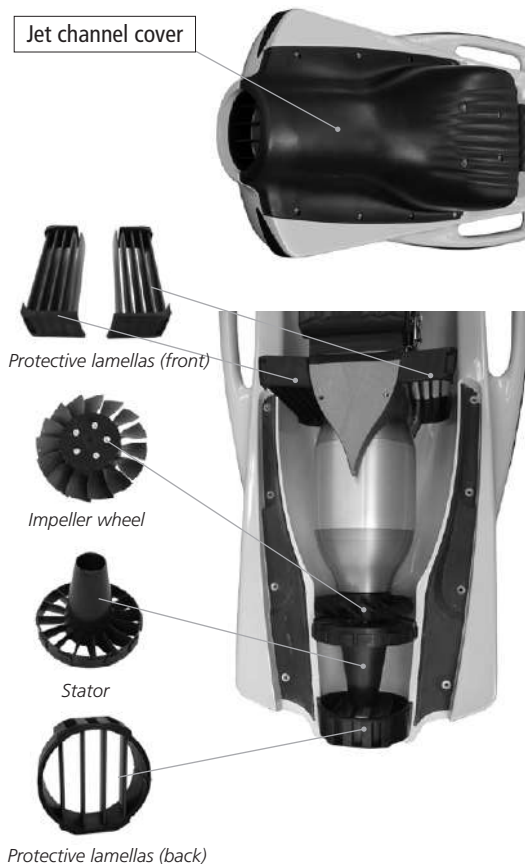

The SEABOB is constructed of high-quality materials that are highly resistant to seawater. For this reason, it is important to observe the following:

STOP When used as fasteners in aluminium material, screws made of rust-resistant steel (V4A) will corrode in salt water, making it impossible to remove them from the aluminium material. For this reason, always apply a small amount of Klüber Staburags NBU 30 PTM lubricating grease to these types of screws before screwing them in.

- Put the jet channel cover back on, and fasten it in place. Use the Allen key (size 5) to tighten all twelve attachment screws (approx. 5 Nm; torque wrench recommended). Before fastening the jet channel cover in place, ensure that the stator is seated properly and locked in position.

⚠ The protective lamellas are attached to the SEABOB housing and should never be removed. Before fastening the jet channel cover in place, check that the protective lamellas are seated properly and securely.

Note: Removing the protective lamellas would not enhance the thrust of the craft.

- Turn the SEABOB back over, and check all components once again to ensure that they are seated properly and securely.
- On models with Accumulator Change System (SEABOB CAYAGO VX2 and SEABOB CAYAGO F7 models), reinsert the accumulator box ACS, switch on the SEABOB with the charger (see Chapter 5.4.5 "Off mode") and check that the motor and impeller can move freely.

STOP Never run the motor out of the water for longer than approx. 10 seconds. The seals of the motor and the hard-coated motor shaft are designed exclusively for use in the water. Operation out of the water can cause overheating due to the lack of water to cool the device, thereby causing irreparable damage to the seals and motor shaft.

7.5 Stator / impeller blades are bent or broken (low thrust or no thrust at all)

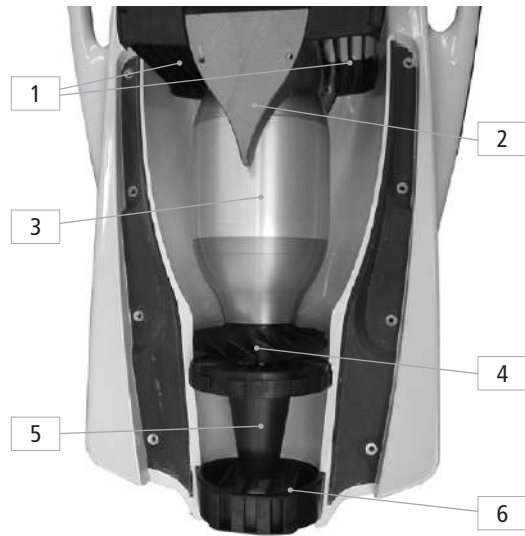

- Protective lamellas (front)
- Electronics box
- Motor
- Impeller wheel with impeller blades
- Stator
- Protective lamellas (back)

The stator and defective impeller blades can be replaced separately. To do this, proceed as follows:

- Remove the jet channel cover as described in Chapter 7.4.
- Remove the stator, and replace it if necessary.
- Unscrew the impeller disc on the impeller wheel to replace individual impeller blades.

4. Use two open-ended spanners (size 17) to remove the two M10 locknuts on the shaft. Pull the impeller wheel off the shaft.

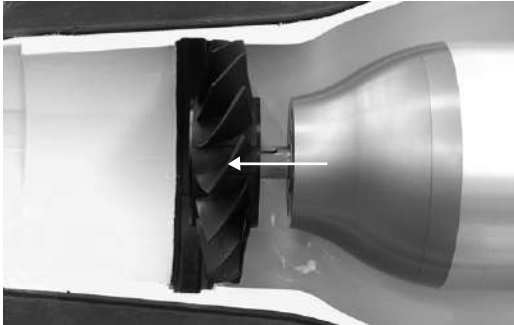

5. Remove the five attachment screws (M5 x 16 stainless steel cheese head screws with hex socket) on the impeller disc using an Allen key (size 4).

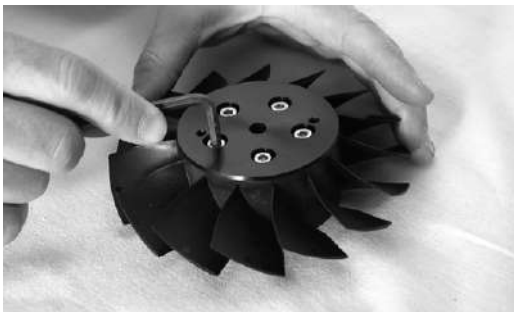

6. Remove the disc by pressing up against the impeller wheel. To do this, use the Allen key to screw two of the attachment screws into the two threaded holes on the impeller disc. Keep turning the screws until the disc comes off. Be sure to turn both screws evenly, so that the impeller disc does not get wedged in.

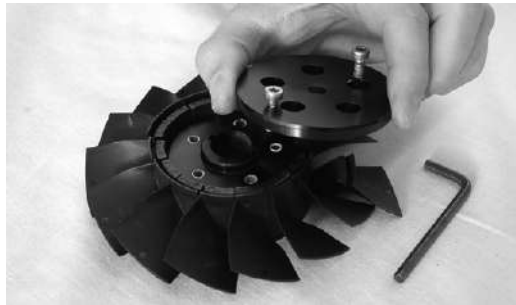
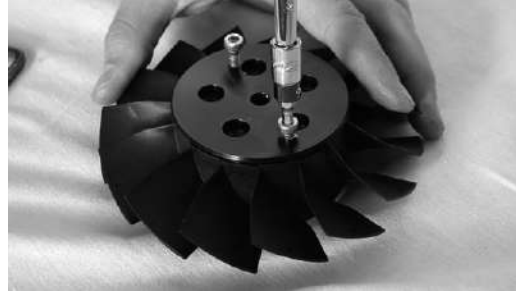

7. Replace any damaged impeller blades. Make sure that the new impeller blades are inserted properly into the groove, so that the curved side of the blades is pointing toward the bow of the SEABOB. Impeller blades that are inserted backwards only produce around one half of the normal thrust.



8. Apply a small amount of Klüber Staburags NBU 30 PTM lubricating grease to the threads of the five M5 x 16 attachment screws. Insert the impeller disc. Use the Allen key (size 4) to retighten the screws (approx. 5 Nm; torque wrench recommended). Be sure to tighten the screws evenly, so that the impeller disc does not get wedged in.
9. Slide the impeller wheel back onto the shaft. Make sure that the keys on the shaft are positioned correctly in the corresponding slots. Use the two open-ended spanners (size 17) to refasten the two M10 locknuts (screw on the self-locking nut last).

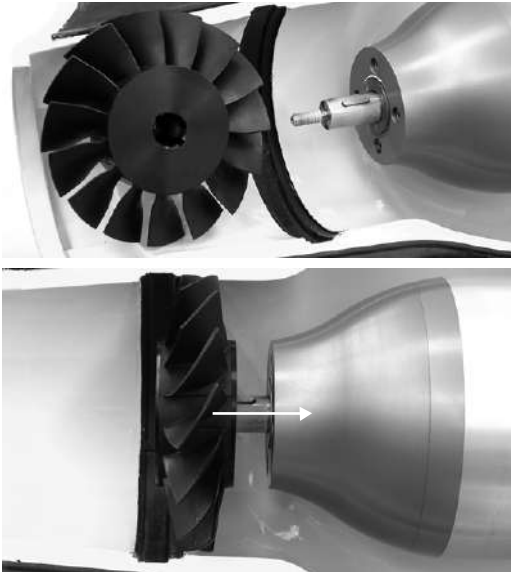

10. Insert the stator. Ensure that the stator locks into place correctly. It should be seated securely in the housing so that it stays in the correct position.

Note: If the stator is missing or spinning freely, little or no thrust is produced in the jet drive system with diffuser.



The protective lamellas are attached to the SEABOB housing and should never be removed. Before fastening the jet channel cover in place, check that the protective lamellas are seated properly and securely.

Note: Removing the protective lamellas would not enhance the thrust of the craft.

11. Put the jet channel cover back on, and fasten it in place as described in Chapter 7.4.

7.6 Powergrip does not function properly

1. Remove dirt or foreign objects from the Powergrip by rinsing it off with fresh water and / or blowing it out with air from a low-pressure hose.
2. The Powergrip may freeze in frosty weather, causing it to stick. Place the SEABOB in the water so that frozen components can thaw off.



A damaged, sticking or bent Powergrip should be repaired or replaced immediately. Contact the manufacturer or your specialist dealer.

7.7 Display does not show entire image

Electrostatic discharge on the SEABOB may cause the display to show only a portion of the full image (for example, only half the image). This can happen especially when a person becomes electrostatically charged by wearing rubber water shoes and then discharges the electricity by touching the SEABOB, in particular around the display.

If this occurs, briefly switch off the SEABOB completely (Off mode or detach accumulator box ACS in a dry place), and then switch it back on. This resets the SEABOB's system and initiates an electronic self check. Afterwards, the problem should be corrected. Electrostatic discharge is only possible on land. It can never occur in water.

7.8 Moisture present on high-current connecting plates (on models with Accumulator Change System)

 If moisture or wetness appears on the electrical high-current connecting plates inside the sealed area between the accumulator box ACS and SEABOB housing (SEABOB CAYAGO VX2 and SEABOB CAYAGO F7 models), the seals are defective and the accumulator box ACS is no longer fit for operation.

Regularly check the sealing surfaces on the accumulator box ACS and SEABOB ACS as well as the sealing rings (quad ring and spacer O-ring) on the motor's electronic system, examining the parts thoroughly for damage and dirt. Replace the parts if necessary (see Chapter 6 "Care").

 Take an accumulator box with defective seals immediately to the manufacturer or your specialist dealer. If you detect any visible damage on the accumulator box or SEABOB, immediately halt operation and contact the manufacturer or your specialist dealer without delay.

 Never use the accumulator box ACS if there is moisture or wetness on the high-current connecting plates inside the sealed area of the device. Water may leak into the accumulator box or may have already done so. Danger of short circuit! There is the danger of flaming gases being discharged through the accumulator cells' safety valve, causing serious injury.

 Never open the accumulator box. Danger of short circuit! Beware of flaming gases that may be discharged, causing injury!

7.9 Moisture present in charging socket

 If moisture or wetness appears inside the sealed area of the charging socket, the seals are defective or the sealing cap was not put on or has been put on incorrectly. Charge the accumulator box only if the charging socket and charging plug are completely clean and dry (see Chapter 5.2 "Charging the accumulator box").

Check the sealing surfaces of the charging socket and sealing cap thoroughly for damage or dirt. Replace the sealing cap if necessary.

 If you detect defective sealing surfaces on the charging socket, you should take the SEABOB immediately to the manufacturer or your specialist dealer. If you detect any visible damage on the SEABOB or accumulator box, immediately halt operation and contact the manufacturer or your specialist dealer without delay.

 Never use a damaged charging plug or charging socket, in particular if the high-current contacts inside the sealed area of the device are damaged. Doing so may cause the contacts and cables to overheat during charging. Water may leak into the accumulator box or may have already done so. Danger of short circuit! There is the danger of flaming gases being discharged through the accumulator cells' safety valve causing serious injury.

 Never open the accumulator box. Danger of short circuit! Beware of flaming gases that may be discharged causing injury!

8. Technical specifications

All specifications are only intended for use in describing the product. They are not to be construed as guaranteed properties. The specifications provided here do not represent absolute values, since certain deviations may occur as a result of manufacturing-related tolerances. Specifications may be changed without notice to take into account new technical advances. As a result, actual product properties may differ from the ones described here.

Housing

- Fibreglass-reinforced hard integral polyurethane plastic technology with polyurethane foam core
- Fibreglass-reinforced epoxy composite materials

Motor / electronics

- Long-lasting and reliable high-performance electro-motor
- Direct drive (without gearbox)
- Electronically commutated (brushless)
- Extremely low wear and highly durable components
- Extremely rugged mechanical and thermal characteristics; electronic temperature monitoring
- Direct water cooling in jet flow channel for continuous output
- Highly resistant to seawater and watertight; able to withstand pressure (diving depth 40 m)
- Shaft output up to 5.2 kW / 7 HP at 2,350 rpm (SEABOB CAYAGO F7)
- High torque up to 22 Nm at 5.2 kW (with exceptionally compact dimensions and low weight)
- High overall efficiency including power electronics (more than 85 %)
- Electronic speed control (10 power levels in 10 % increments)

Special motor sealing case

- Multiple-stage sealing rings for redundant seal effect throughout the sealing system
- Special rotary shaft seals are mounted in multiple stages on a special hard-coated stainless steel drive shaft for lasting and reliable protection against water ingress.
- Long-term testing has shown that the use of optimally matched materials both on the drive shaft and in the sealing case provides a reliable means of overcoming the high temperatures created by friction during operation as well as the strong chemical reactions of the water in the sealing system occurring when the water is heated to temperatures of up to 150 °C / 302 °F. This, in turn, ensures the extremely long operating life of the device.
- Additional preliminary-stage felt rings designed to protect the sealing rings from contamination
- Replaceable sealing case for service

Drive

Electric jet impeller; low-wear direct drive with guide vanes stator and diffuser system

Thrust / tractive force:

- SEABOB RAVEJET with 8 accumulator cells (2.2 kW / 3 HP): up to 349 N
- SEABOB JET 4.12 with 12 accumulator cells (2.9 kW / 4 HP): up to 468 N
- SEABOB CAYAGO VX2 with 12 accumulator cells (3.7 kW / 5 HP): up to 570 N
- SEABOB CAYAGO F7 with 14 accumulator cells (5.2 kW / 7 HP): up to 734 N

Accumulator box

- Aluminium accumulator box is highly resistant to seawater for direct water cooling; encased in watertight shell constructed of fibreglass-reinforced high-grade epoxy composite materials; can withstand pressures of up to 12 bar.
- Integrated microprocessor-controlled accumulator management system for controlled charging / discharging and easy operation
- Accumulator Change System (SEABOB CAYAGO VX2 and SEABOB CAYAGO F7 models): replaceable accumulator box
ACS makes it possible to change the accumulator box. High-current contacts equipped with a special seal system are used to establish the connection to the motor's electronic system.

Accumulators / power

SEABOB RAVEJET:

3 HP using 8 High-Energy Lithium-Ion accumulator cells; approx. 1.2 kW/h; 32 V; 40 Ah

SEABOB JET 4.12:

4 HP using 12 High-Energy Lithium-Ion accumulator cells; approx. 1.8 kW/h; 48 V; 40 Ah

SEABOB CAYAGO VX2:

5 HP using 12 High-Energy Lithium-Ion accumulator cells; approx. 1.8 kW/h; 48 V; 40 Ah

SEABOB CAYAGO F7:

7 HP using 14 High-Energy Lithium-Ion accumulator cells; approx. 2.1 kW/h; 56 V; 40 Ah

- No memory effect; long life, high performance and high energy density
- Weight: only 1.07 kg per High-Energy Lithium-Ion accumulator cell
- Temperature range for transport / storage: -40 to +60 °C / -40 to +140 °F
- Recommended storage temperature: +10 to +25 °C / +50 to +77 °F
- Operating temperature range: -10 to +45 °C / +14 to +113 °F

Threshold values for Li-Ion accumulator cells monitored by the accumulator management system

- 2.5 V: minimum cell voltage for charging (Falling below this limit results in irreparable total discharge: Charging is no longer possible!)
- 4.0 V: maximum charging voltage (charging is stopped)
- 2.7 V: minimum discharging voltage under load (motor stops)
- 3.0 V: minimum discharging voltage without load (motor stops)
- 40 °C / 104 °F: charging temperature warning (temperature display and accumulator symbol flashing)
- 45 °C / 113 °F: maximum charging temperature (charging is stopped)
- 55 °C / 131 °F: discharging temperature warning (power limited to 30 %)
- 60 °C / 140 °F: maximum discharging temperature (motor stops)
- 140 A: maximum permissible momentary discharging current (motor stops)
- 30 A: maximum charging current

Charging time

- SEABOB RAVEJET (8 accumulator cells): approx. 6-8 hours
- SEABOB JET 4.12 (12 accumulator cells): approx. 8-10 hours
- SEABOB CAYAGO VX2 (12 accumulator cells): approx. 8-10 hours
- SEABOB CAYAGO F7 (14 accumulator cells): approx. 10-12 hours

Using the optionally available quick charger reduces the charging time to only approx. 90-110 minutes (charging time may be longer if mains voltage is under 230V).

Dimensions

- SEABOB RAVEJET, SEABOB JET 4.12, SEABOB CAYAGO VX2 and SEABOB CAYAGO F7 when ready for operation (with accumulator box):
L x W x H: 1,296 mm x 481 mm x 379 mm
- SEABOB CAYAGO VX2 and SEABOB CAYAGO F7 without accumulator box:
L x W x H: 1,058 mm x 481 mm x 379 mm
- Accumulator box ACS (incl. bow):
L x W x H: 764 mm x 374 mm x 299 mm

Weight

- Ready for operation with accumulator box (incl. 8-14 accumulator cells):
- SEABOB RAVEJET: approx. 59 kg
 - SEABOB JET 4.12: approx. 63 kg
 - SEABOB CAYAGO VX2: approx. 64 kg
 - SEABOB CAYAGO F7: approx. 64 kg

Buoyancy in fresh water

- SEABOB RAVEJET: approx. 14 kg
- SEABOB JET 4.12: approx. 10 kg
- SEABOB CAYAGO VX2: approx. 9 kg
- SEABOB CAYAGO F7: approx. 8 kg

Motor control

Electronic power control using piezo-actuated buttons to adjust power in increments of 10 % (10 power levels)

Steering

By shifting weight and legs

Stopping / braking

Motor stops when Powergrip on right Controlgrip is released. Water resistance halts the craft.

Speed

Depends on the water resistance of the SEABOB user and the set power

SEABOB RAVEJET:

- Over water: up to 12 km/h
- Under water: up to 10 km/h

SEABOB JET 4.12:

- Over water: up to 15 km/h
- Under water: up to 12 km/h

SEABOB CAYAGO VX2:

- Over water: up to 18 km/h
- Under water: up to 14 km/h

SEABOB CAYAGO F7:

- Over water: up to 22 km/h
- Under water: up to 16 km/h

Operating time

- SEABOB RAVEJET: average 60 minutes
- SEABOB JET 4.12: average 75 minutes
- SEABOB CAYAGO VX2: average 60 minutes
- SEABOB CAYAGO F7: average 60 minutes

Maximum diving depth

SEABOB RAVEJET, SEABOB JET 4.12, SEABOB CAYAGO VX2 and SEABOB CAYAGO F7: each 40 m

(see Chapter 5.8.1 "Setting the maximum diving depth")

Depth gauge

- Built-in stainless steel diving gauge with integrated, seawater-resistant ceramic sensor
- Temperature compensated
- Compares zero point and final value
- Air pressure is equalised before scuba diving (re-set when switching on the SEABOB / installing the accumulator box ACS).

Care

No special maintenance is required if the instructions for care are adhered to (cleaning of the device and possible replacement of wearing parts).

Recommended: Have the SEABOB (for example, the motor sealing case) checked by the manufacturer or specialist dealer after approx. 3,000 hours of motor operation.

Impact on the environment

Emission-free and virtually silent operation



EG-Konformitätserklärung / EC-Declaration of Conformity

Nr. / No.: 002/08
Wir / We: CAYAGO AG
Name des Anbieters / supplier's name
Anschrift / Address: Flachter Str. 32, 70499 Stuttgart, GERMANY

erklären in alleiniger Verantwortung, dass das Produkt / declare under our sole responsibility that the product:
Wassersportfahrzeug / water-sports craft

Bezeichnung, Typ oder Modell, Los- oder Seriennummer / Name, type or model, batch or serial number:
SEABOB RAVEJET / SEABOB JET 4.12 / SEABOB CAYAGO VX2 / SEABOB CAYAGO F7

mit den Vorschriften folgender Europäischer Richtlinie(n) übereinstimmt / complies with the requirements of the following European directive(s):

EMV-Richtlinie Nr.: 89/336/EWG (geändert durch Richtlinien 91/263/EWG, 92/31/EWG und 93/68/EWG)
EMC Directive No.: 89/336/EEC (changed by directives 91/263/EEC, 92/31/EEC and 93/68/EEC)

Die Übereinstimmung des bezeichneten Produkts mit den Anforderungen dieser Richtlinie(n) wurde geprüft durch Anwendung folgender Normen / The compliance of the above product with the requirements of this directive(s) was proved by the application of the following standards:

EN 61000-6-1:2001 Elektromagnetische Verträglichkeit – Teil 6-1:
Fachgrundnorm – Störfestigkeit für Wohnbereich, Geschäfts- und Gewerbebereiche sowie Kleinbetriebe
Electromagnetic compatibility – Part 6-1:
Generic Standards – Immunity for residential, commercial and light-industrial environments
EN 61000-6-3:2001 Elektromagnetische Verträglichkeit – Teil 6-3:
+ A11:2004 Fachgrundnorm – Störaussendung für Wohnbereich, Geschäfts- und Gewerbebereiche sowie Kleinbetriebe
Electromagnetic compatibility – Part 6-3:
Generic Standards – Emission standard for residential, commercial and light-industrial environments

Das Produkt ist mit dem CE-Zeichen ausgezeichnet. Jegliche nicht autorisierte Modifikation des Produktes hebt diese Erklärung auf.
The product is labelled with the European Approvals Marking CE. Any unauthorized modification of the product voids this declaration.

Hinweise zur Betriebsumgebung der Erzeugnisse:

Die zur Beurteilung des Produktes herangezogenen Normen legen Grenzwerte für den Einsatz im Wohnbereich, Geschäfts- und Gewerbebereich sowie in Kleinbetrieben fest. Bei dem Einsatz in einer elektromagnetisch stärker gestörten Umgebung, wie z.B. der typischen Industrieumgebung, können insbesondere Probleme mit einer nicht ausreichenden Störfestigkeit der Erzeugnisse auftreten.

Information regarding the operating environment of the products:

The standards used in evaluating the product specify limits for operation in residential, commercial and light industrial environments. Using the product in an environment where there is a higher level of electromagnetic radiation such as a normal industrial environment may cause problems due to the insufficient immunity of the products.

Der oben genannte Hersteller hält die erforderliche Dokumentation zur Einsicht bereit. / The required documentation is kept by the manufacturer specified above for inspection.

Stuttgart, 07.01.2008
Ort und Datum der Ausstellung
Place and date of issue

Vorstand
Board (CEO)

9. Disposal

An accumulator box that is defective or no longer deliver sufficient performance must be disposed of in accordance with applicable guidelines.

Lithium-Ion accumulators must be professionally disposed of and recycled. An accumulator box that is defective or no longer deliver sufficient performance should be returned to the manufacturer or your specialist dealer for professional disposal and recycling.

10. Replacement parts

- ACS spacer O-ring (sealing ring)
- ACS quad ring (sealing ring)
- Sealing cap (for charging socket)
- Impeller blades
- Stator

11. Accessories

- Extra accumulator box ACS (Accumulator Change System) for SEABOB CAYAGO VX2 model
- Extra accumulator box ACS (Accumulator Change System) for SEABOB CAYAGO F7 model
- Quick charger for SEABOB RAVEJET model:
wide range input 100-240 V; 32 V; 30 A
- Quick charger for SEABOB JET 4.12 model:
wide range input 100-240 V; 48 V; 30 A
- Quick charger for SEABOB CAYAGO VX2 model:
wide range input 100-240 V; 48 V; 30 A
- Quick charger for SEABOB CAYAGO F7 model:
wide range input 100-240 V; 56 V; 30 A
- SEABOB-Bag
- SEABOB-Cart
- SEABOB-Rack
- SEABOB-Case
- Buoyancy adjustment weight
- Pilot belt system for SEABOB CAYAGO F7 model
- CD with extra software and quick reference serial IrDA infrared adapter (used to activate the PIN prompt when switching on the device or to activate and change the User-PIN)

12. Service

For service or repairs, please contact CAYAGO AG:

- by e-mail at service@seabob.com
- by phone at +49 (0)7 11 - 99 33 97 - 0
(Mon-Fri, 9:00 a.m. to 5:00 p.m. CET, except on public holidays)

or your specialist dealer.

Please have the following information ready:

- Model name
- SEABOB serial number
- Accumulator box serial number
- Service / error messages appearing on the display
- Exact description of the malfunction or damage

A specialist will assist you in identifying the cause of the error and take further action if necessary.

13. Imprint

CAYAGO AG
Flachter Str. 32
D-70499 Stuttgart
GERMANY

Phone +49 (0)7 11 - 99 33 97 - 0
Fax +49 (0)7 11 - 99 33 97 - 33

info@seabob.com
www.seabob.com

As of March 2008

© 2008 CAYAGO AG

Copying, transmitting, storing or translating this Operation Manual in any shape or form, whether in part or whole, is not permitted without the prior written consent of CAYAGO AG.

Technical tolerances and changes reserved.

