



OWNER'S MANUAL

Boating Safety Checklist

MUST HAVE ITEMS

As Required By Regulation

Personal Flotation Devices (Life Jackets)

- Type I, II, III, or V for **each person onboard** (Wearable)
- One Type IV (Throwable)
Not Required on Non-Powered boats under 16'

Fire Extinguishers

Choose One	Boats w/out Fixed System		Boats w/ Fixed System
<input type="checkbox"/> Boats <26'	1 Size BI	- OR -	Fixed System
<input type="checkbox"/> Boats 26 - <40'	2 Size BI*	- OR -	Fixed System + 1 Size BI
<input type="checkbox"/> Boats 40 - 65'	3 Size BI*	- OR -	Fixed system + 2 Size BI*

* One Size BII may be substituted for Two Size BI Extinguishers

Visual Distress Signals (VDS)

Choose One

- Combination Day/Night VDS (Flares or Flare Gun)
- Daytime VDS (Flags, Smoke Signal)
AND
Nighttime VDS (Automated SOS Light)

Sound Signals

- Horn or Whistle
- Bell (Not required for vessels under 12m)

Ventilation (Boats with Gasoline Systems)

- Natural Ventilation
- Powered Ventilation

Backfire Flame Control

- Backfire Flame Arrestor (Gasoline Engines except outboards)

- The above represents minimum USCG Safety Requirements on-board vessels.
- Other Requirements may be necessary to comply with state laws.
- This is not intended to be an all-inclusive list but rather a baseline of items to make your boating adventure safe and fun.
- For Vessels over 65' refer to 33CFR 25.30-20 or ABYC A-4.



Boating Safety Checklist

Recommended Items

Items in Red May be Required in Some States

Boats on Inland Waters Everything on Required List PLUS:

- | | |
|---|---|
| <input type="checkbox"/> First Aid Kit | <input type="checkbox"/> Boating Safety Education/
Certificate |
| <input type="checkbox"/> Anchor with Sufficient Line | <input type="checkbox"/> Watersports Flag
(Skier Down/Diver Down Flag) |
| <input type="checkbox"/> Bailing Device | |
| <input type="checkbox"/> Sun Protection | |
| <input type="checkbox"/> Alternate Propulsion (Paddles, Oars) | |

Boats on Nearshore Waters Everything Above PLUS:

- | | |
|---|---|
| <input type="checkbox"/> Extra Food & Water | <input type="checkbox"/> GPS/Chartplotter |
| <input type="checkbox"/> Float Plan | <input type="checkbox"/> Depth Finder |
| <input type="checkbox"/> Compass | <input type="checkbox"/> Charts |
| <input type="checkbox"/> VHF Radio | <input type="checkbox"/> Spare Tool Kit |

Boats on Offshore Waters Everything Above PLUS:

- | | |
|---|---|
| <input type="checkbox"/> EPIRB | <input type="checkbox"/> Man-Overboard Recovery Gear |
| <input type="checkbox"/> Life Raft | <input type="checkbox"/> AIS |
| <input type="checkbox"/> Searchlight | <input type="checkbox"/> Sea Drogue |
| <input type="checkbox"/> List of CPR Instruction | <input type="checkbox"/> Safety Knife |
| <input type="checkbox"/> Radar | <input type="checkbox"/> Weather Information System |
| <input type="checkbox"/> Radar Reflector | <input type="checkbox"/> Radio Direction Finder |
| <input type="checkbox"/> Shore Landing Craft (Tender) | <input type="checkbox"/> Long Range Communications Gear |

Boats on River Waters Everything on Required List Plus:

- | | |
|------------------------------------|---------------------------------|
| <input type="checkbox"/> Throw Bag | <input type="checkbox"/> Helmet |
|------------------------------------|---------------------------------|

Miscellaneous Items Other Items That May be Recommended:

- | | |
|---|--|
| <input type="checkbox"/> Heaving Line | <input type="checkbox"/> Strobe Light |
| <input type="checkbox"/> Spare Keys | <input type="checkbox"/> Carbon Monoxide Detector |
| <input type="checkbox"/> Boat Hook/Pole | <input type="checkbox"/> Extra Clothing |
| <input type="checkbox"/> Spare Propeller | <input type="checkbox"/> Marine Hardware |
| <input type="checkbox"/> Extra Engine Oil | <input type="checkbox"/> Masks & Fins (For Clearing Props) |
| <input type="checkbox"/> Handheld Lead-line | <input type="checkbox"/> Storm Sails |

Scan here to download
the ABYC Boating Safety
Checklist App
abycinc.org/mobileapps



TABLE OF CONTENTS

Introduction	1-1
Congratulations	1-1
About This Manual	1-1
About Your New Boat	1-1
Safety	2-1
Good Boating Practices	2-1
Safety Decals and Statements	2-3
Carbon Monoxide	2-5
Required Boating Safety Equipment and Regulations	2-7
Recommended Safety Equipment	2-12
Water Sports Safety	2-13
Boating Regulations and Your Responsibilities	3-1
Boat Owner / Operator Responsibilities	3-1
Safety	3-1
Registration	3-1
Insurance	3-2
Reporting Accidents	3-2
Operation by Minors	3-2
Boating Under the Influence	3-2
Operator's License and Education	3-2
Emergency Assistance	3-3
Protecting the Environment	3-3
Fishing	3-3
Foreign Species Transportation	3-3
Wake	3-3
Noise	3-3
Speed	3-3
Pollution Regulations	3-4
Emergencies	4-1
First Aid / Medical Emergencies	4-1
Emergency Preparation Checklist	4-1
Carbon Monoxide Poisoning	4-1
Using Distress Signal Devices and Calling for Help	4-1
Fire and Explosion	4-2
Man Overboard	4-3
Capsizing and Flooding	4-4
Running Aground	4-4
Dangerous Weather	4-4
Engine or Boat System Failure	4-4
Accidents, Collisions and Giving Assistance	4-5
Towing on the Water	4-5
Operating in Hazardous Conditions	5-1
Severe Weather	5-1
Water Hazards	5-2



Restricted Areas	5-2
Markers, Warnings and Advisories	5-2
Navigation Rules and Aids	6-1
Right-of-Way	6-1
Audible Distress Signals	6-1
Navigational Lights and Night Operation	6-1
Speed	6-2
Wake	6-2
Overtaking / Passing	6-2
Meeting Head-On	6-3
Crossing	6-3
Aids to Navigation	6-4
Operating Your Boat	7-1
Safety Precautions	7-1
Before Getting Under Way	7-1
Getting Under Way	7-4
Trailering and Launching	8-1
Legal Considerations	8-1
Trailer Classification	8-1
Trailer Type	8-1
Trailer Gross Vehicle Weight Rating	8-1
Towing Vehicle	8-1
Vehicle Towing Hitch	8-1
Hitch Ball and Trailer Coupler	8-2
Safety Chains	8-3
Trailer Brakes	8-3
Trailering Guidelines	8-4
Launching	8-5
Loading Guidelines	8-6
Trailer Tires	8-7
Reporting Safety Defects	8-10
Boat Features and Options	9-1
Fuel System	9-1
Engine Lubrication System	9-1
Engine Cooling System	9-1
Steering System	9-2
Shift and Throttle Controls	9-3
Electrical System	9-4
Propellers	9-7
Gauges / Instruments	9-9
Helm and Control Switches	9-12
Bilge Pump System	9-14
Boat Ventilation System	9-15
Freshwater System	9-15
Raw Water System	9-17
Livewells	9-19
Head and Waste Containment System	9-21



Table of Contents

General Care and Maintenance	10-1
Engine	10-1
Fuel System	10-1
Electrical System	10-1
Steering System	10-3
Corrosion Protection	10-4
General Maintenance and Cleaning	10-5
Freshwater System	10-8
Raw Water System	10-8
Head and Waste Containment System	10-9
Safety Equipment	10-9
General Boating Equipment	10-9
Trailer	10-9
Winterization and Storage	11-1
Winterization and Storage Preparation	11-1
Storing on a Cradle or Blocks	11-2
Storing on a Trailer	11-2
Recommissioning After Storage	11-2
Lifting	11-4
Troubleshooting	12-1
Glossary of Nautical Terms	13-1
Index	1-1



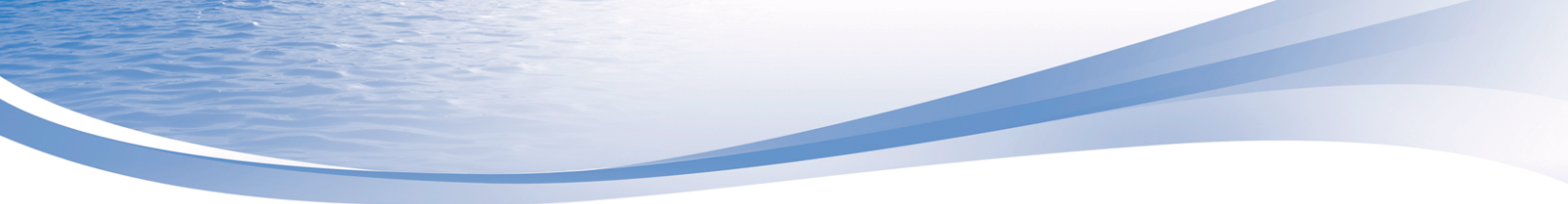

Section 1

INTRODUCTION

CONGRATULATIONS

Congratulations and Welcome Aboard! To ensure each boating experience is a safe and enjoyable one, please read all the literature provided with your newly purchased boat carefully before operating the boat or any equipment.

ABOUT THIS MANUAL

Please keep this manual on-board for future reference and pass it along to the new owner if you ever decide to sell your boat.

This manual has been written as a general guide to safe operating practices, boating regulations and maintenance techniques for recreational boating.

This manual is not intended to be used as a replacement for specific information and procedures covered in manuals provided by the manufacturer of the engine, trailer and other major equipment.

Because we are constantly working toward product improvement, this manual is intended to be a general guide only. The illustrations used in this manual may not exactly match the equipment on your boat; they are intended only as general reference views.

If this is your first time owning or operating a boat, it is recommended that you contact your dealer or local boating agency to find out how to enroll in a boater safety course prior to operating your boat.

ABOUT YOUR NEW BOAT

Boat Terminology

It is important that you understand, learn and use appropriate and common nautical terminology while boating to ensure your safety and the safety of others.

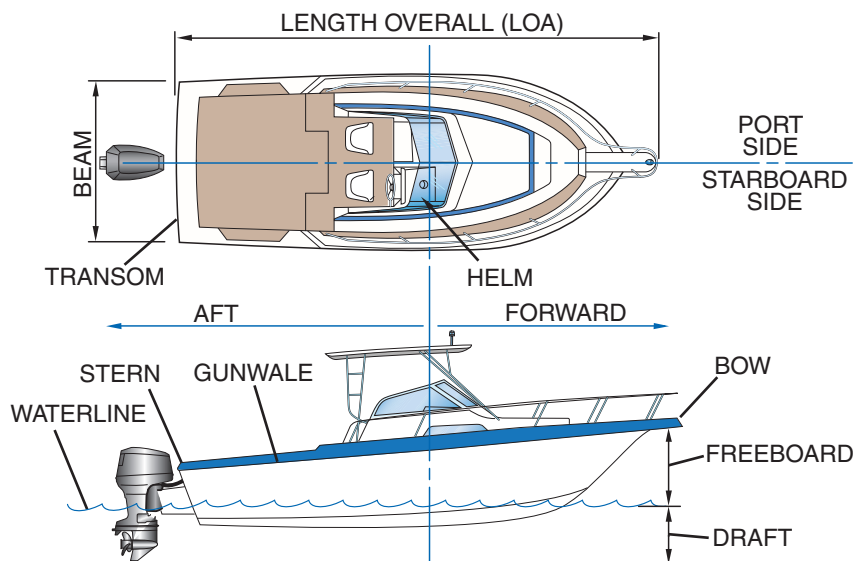

KC-0072C-A

See the *Glossary of Nautical Terms* on page 13-1 for additional boating terminology.



Section 1

Hull Identification, Capacity and Safety Plates

Hull Identification Number

The hull identification number (HIN) is usually located near the upper starboard corner of the transom on the outside of the boat. In some instances, the HIN may be located in an alternate location as determined by the manufacturer (e.g., a pontoon HIN may be located on the aft crossmember approximately 1 foot (0.3 meters) from the starboard hull attachment). The HIN must be clearly visible and may not be removed, altered or tampered with in any way as regulated by federal law.

In case of collision, theft or damage, report these numbers to the local authorities, your insurance agent and your dealer.

Safeguard information about your boat by recording the HIN and model of your boat, and model and serial numbers of the engine, trailer and accessories on the *Boat Information Form* on page 1-4.

U.S. Coast Guard Safety Standards Compliance Plate

All power boats less than 20 feet (6 meters) must have a manufacturer's compliance plate clearly indicating that your boat is in compliance with the USCG safety standards and the effective date of the compliance. The compliance plate may be combined onto one plate showing both the capacity plate and compliance information by the manufacturer.

Capacity Plate

All mono-hull recreational boats less than 20 feet (6 meters) require a gross weight and person-capacity plate to be clearly displayed as provided by the manufacturer.

Boats in the National Marine Manufacturers Association (NMMA) program up to 26 feet (7.9 meters) have a maximum rated load capacity, which is stated on the certification plate (if equipped).

The person/load capacity is determined by the USCG. The capacity plate is usually located within clear visibility of the boat operator or helm

area. The capacity plate indicates limits for loading the boat, which are enforceable by law. Never exceed the "U.S. Coast Guard Maximum Capacities" indicated on the capacity plate.

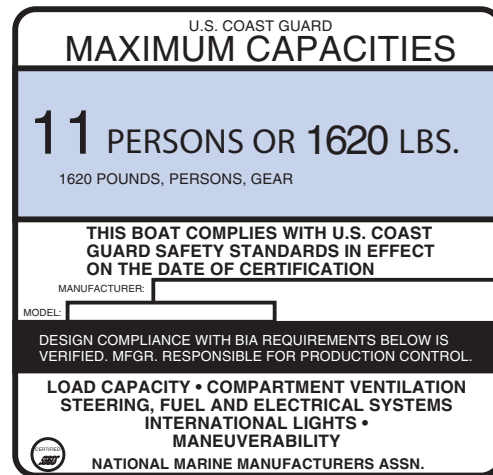

KC-0038-A

Figure 1-1

References and Contact Information

Use the following list of publications and organizations for reference and contact information concerning safe boating, navigational rules and other boating topics.

Publications

- Bottomley, Tom. *Boatman's Handbook*. Hearst Marine Book. Morrow
- Brotherton, Miner. *Twelve Volt Bible*. Seven Seas
- Chapman, Charles F. and Maloney, E.S. *Chapman's Piloting, Seamanship and Small Boat Handling*. Hearst Marine Book. Morrow
- Damford, Don. *Anchoring*. Seven Seas
- National Fire Protection Association. *Fire Protection Standard for Pleasure and Commercial Motor Craft*. National Fire Protection Association
- Strahm, Virgil. *Does Your Fiberglass Boat Need Repair?* Strahm
- United States Coast Guard. *Navigational Rules for U.S. Waterways*. United States Coast Guard. Visit <http://www.navcen.uscg.gov/mwv/NavRules> to view or download this publication.



- United States Coast Guard Auxiliary. *Boating Skills and Seamanship Thirteenth Edition*. United States Coast Guard
- Whiting, John and Bottomley, Tom. *Chapman's Log and Owner's Manual*. Hearst Marine Book

Organizations

American Boat & Yacht Council

<http://abycinc.org>

American Red Cross

<http://www.redcross.org> or consult your local telephone directory

Boat Owners Association of The United States

<http://www.boatus.com/>

BoatU.S. Foundation for Boating Safety Hotline

<http://www.boatus.org/onlinecourse>
Phone: 800-336-BOAT (In Virginia call 800-245-BOAT)

National Association of State Boating Law Administrators

<http://www.nasbla.org>

National Marine Manufacturers Association

<http://www.nmma.org>

National Oceanic and Atmospheric Administration's National Weather Service

<http://www.nws.noaa.gov>

National Safe Boating Council Inc.

<http://www.safeboatingcouncil.org>

Sea Tow Services International, Inc.

<http://www.seatow.com>; Phone: 631-765-3660;
Fax: 631-765-5802
Toll free: 800-4SEATOW (800-473-2869)

U.S. Coast Guard

<http://www.uscg.mil> (To contact the U.S. Coast Guard for an emergency while on the water, always use your on-board VHF-FM radio Channel 16. Use cell phones only as a secondary means of communication. Call 9-1-1 to reach rescue personnel.)

U.S. Coast Guard Auxiliary

<http://nws.cgaux.org>; Phone: 877-875-6296

U.S. Coast Guard Auxiliary – Float Plan Information

<http://www.floatplan.uscgaux.info>

U.S. Coast Guard Navigation Center (NAVCEN)

<http://www.navcen.uscg.gov>

U.S. Coast Guard Office of Boating Safety

<http://www.uscgboating.org>

U.S. Coast Guard Pollution Control National Response Center

Phone: 800-424-8802

U.S. Coast Guard's America's Waterway Watch Program

(A program for recreational boaters to assist the U.S. Department of Homeland Security in reporting suspicious activity on U.S. waterways)
Phone: 877-24-WATCH (877-249-2824)

U.S. Government Printing Office

Website - <http://www.gpoaccess.gov>
(For information and documentation on FCC rules and regulations and Skippers Course information, and other government, marine and nautical related documents)

U.S. Power Squadrons

<http://www.usps.org>; Phone: 888-367-8777



Section 1

Boat Information Form



Section 2

SAFETY

The popularity of boating and other water sports has undergone an explosion of growth in the past few years, making safety an important issue for everyone who shares in the use of our waterways.

WARNING! Read and understand this Operator's Manual, the Engine Operator's Manual and all manufacturer-supplied information regarding the operation of equipment. As a boat owner, you must understand all safety information responsibilities, regulations, controls and operating instructions before attempting to operate your boat. Improper operation can be extremely dangerous and/or fatal.

The safety content and precautions listed in this manual and on the boat are not all-inclusive. If a procedure, method, tool or part is not specifically recommended, you must feel confident that it is safe for you and others, and that your boat will not be damaged or become unsafe as a result of your decision. REMEMBER – ALWAYS USE COMMON SENSE WHEN BOATING!

As a boat owner, you are responsible for your own safety, as well as that of your passengers and other boaters.

GOOD BOATING PRACTICES

Boating-related accidents are generally caused by the operator's failure to follow basic safety rules or written precautions. Most accidents can be avoided if you are completely familiar with your boat and its operation and can recognize potentially hazardous situations.

In addition to everyday safety, failure to observe safety recommendations may result in severe personal injury or death to you or to others. Use caution and common sense when operating your boat. Do not take unnecessary chances! Failure to adhere to these warnings may result in severe injury or death to you and/or others.

Read this entire manual and be aware of other specific safety guidelines not listed below. Seek additional safety information from the USCG and state and local authorities. In addition to specific safety statements noted in this manual, a general list of safety guidelines and recommendations is listed below:

- Your boat must comply with USCG safety equipment regulations.
- Before each outing, check all safety equipment such as fire extinguishers, personal flotation devices (PFDs), flares, distress flags, flashlights and engine emergency stop switch. Make sure they are operable, in good condition, readily visible and easily accessed.
- On-board equipment must always conform to the governing federal, state and local regulations.
- Never allow any type of spark or open flame on-board. It may result in fire or explosion.
- Take the keys with you when you leave your boat to keep untrained and unauthorized persons from operating your boat.
- Know how to react correctly to adverse weather conditions, have good navigation skills and follow navigational rules as defined by USCG, state and local regulations.
- Check local weather reports before casting off. Do not leave the dock area when strong winds and electrical storms are in the area or predicted to be in the area.
- Seek shelter from open water if lightning is an imminent threat.
- Tell someone of your travel plans before departing.
- Know the weight capacity of your boat. Never overload your boat.
- Never operate your boat while under the influence of drugs or alcohol.
- Look before you turn your boat. As a boater, you are obligated to maintain a course and speed unless it is safe to alter course and speed. Look before you turn.



Section 2

- You, as the operator, must read and understand all operating manuals supplied with your boat before operation.
- Whenever you are going for an outing, make sure that at least one passenger is familiar with the operation and safety aspects of your boat in case of emergency.
- Do not allow passengers to sit in front of the operator; always avoid obstructing the operator's view.
- Show all passengers the location of emergency equipment and explain how to use it.
- Never allow passengers to drag their feet or hands in the water, or sit on the bow, bow pulpit, deck or gunwale while the engine is running.
- Never use or hold onto the boarding platform while the engine is running.
- Never stand or allow passengers to stand in the boat or sit on the transom, seat backs, engine cover or sides of the boat while the engine is running. You or others may be thrown from your boat.
- Children and nonswimmers must wear a life jacket at all times.
- Never leave children in the boat without adult supervision.
- Improper operation of your boat is extremely dangerous.
- Securely attach the engine emergency stop switch lanyard to a part of your clothing, such as a belt loop, when operating your boat.
- Operate slowly in congested areas such as marinas and mooring areas.
- The bow may be slippery. Do not go forward while the engine is running.
- Slow down when crossing waves or wake in order to minimize the impact on passengers and the boat.
- Never dive from your boat without being absolutely sure of the depth of the water; severe injury or death may occur from striking the bottom or submerged objects.
- Never swim near a boat when the engine is running. Even if the boat is in the NEUTRAL position, the propeller may still be turning and carbon monoxide may be present.
- Never wrap ski lines or mooring lines around any body part. You could become entangled in the line if you fall overboard while the boat is moving.
- Keep track of ski lines and dock lines so they do not become entangled in the propeller.
- Watch for other boats, swimmers and obstructions in the water. Stay away from other boats and personal watercraft.
- Have an experienced operator at the helm and always have at least three people present for safe towing – one to drive, one to observe, and one to ski or ride.
- Never replace your boat's marine parts with automotive parts (if applicable).
- Never remove or modify any components of the fuel system. Always have qualified personnel perform fuel system maintenance. Tampering with fuel components may cause a hazardous condition.
- Avoid contact with engine exhaust gases – engine exhaust contains carbon monoxide.
- Never operate the engine in a confined space.
- Never go under the boat cover with the engine running or shortly after the engine has been running.
- Allow adequate ventilation with fresh air before entering any enclosed areas.



SAFETY DECALS AND STATEMENTS

Safety Decals

Your boat is affixed with various hazard and safety decals at the time of manufacture. These decals appear in specific locations on the boat and on equipment where safety is of particular concern. Hazard and safety decals must remain legible. If you suspect a decal is missing or one becomes damaged, contact your dealer for immediate replacement.

Safety Statements

There is no substitute for common sense and careful practices. Improper practices or carelessness can cause burns, cuts, mutilation, asphyxiation, other bodily injury or death. This information contains general safety precautions and guidelines that must be followed to reduce risk to personal safety. Special safety precautions are listed in specific procedures. Read and understand all of the safety precautions before operation or performing repairs or maintenance.



Note: This safety alert symbol appears with most safety statements. It means attention, become alert, your safety is involved! Please read and abide by the message that follows the safety alert symbol.

DANGER

Indicates a hazardous situation which, if not avoided, *will* result in death or serious injury.

WARNING

Indicates a hazardous situation which, if not avoided, *could* result in death or serious injury.

CAUTION

Indicates a hazardous situation which, if not avoided, *could* result in minor or moderate injury.

NOTICE

Used to address practices not related to personal injury.

Safety Precautions

DANGER

The safety messages that follow have **DANGER** level hazards.

These safety messages describe hazardous situations which, if not avoided, *will* result in death or serious injury.

Do not permit anyone to launch, operate or retrieve your boat without proper training.

- Read and understand this operator's manual and all manufacturer-supplied information before you operate or service your boat to ensure that you follow safe operating practices and maintenance procedures.
- Safety signs and decals are additional reminders for safe operating and maintenance techniques.
- See your authorized boat dealer for additional training.

Exhaust Hazard

Carbon monoxide (CO) is a colorless and odorless gas produced by all engines, fuel-burning appliances, and any material that contains carbon and is burned.



- Even with the best boat design and construction, plus the utmost care in inspection, operation and maintenance, hazardous levels of CO may still be present in accommodation areas under certain conditions. To reduce CO accumulation, always provide adequate ventilation in the boat interior by opening the deck hatches, windows or canvas.
- Do not confuse carbon monoxide poisoning with seasickness, intoxication or heat stress. If someone complains of irritated eyes, headache, nausea, weakness, dizziness or drowsiness, or you suspect carbon monoxide poisoning, immediately move the person to fresh air, investigate the cause and take



Section 2

corrective action. Seek medical attention if necessary.

DANGER

Explosion Hazard



While the engine is running or the battery is charging, hydrogen gas is being produced and can be easily ignited. Keep the area

around the battery well-ventilated and keep sparks, open flames and any other form of ignition out of the area.

WARNING

The safety messages that follow have **WARNING** level hazards.

These safety messages describe hazardous situations which, if not avoided, *could* result in death or serious injury.

Fire and Explosion Hazard



Gasoline is extremely flammable and highly explosive under certain conditions.

- Do not smoke or allow open flames or sparks nearby when refueling.
- Stop all engines, motors and fans before refueling.
- Maintain contact between the fuel nozzle and the fuel tank or container to prevent electrostatic spark. Do not use a plastic funnel.
- Run the blower (if equipped) to clear the engine compartment of gasoline vapors for at least five minutes **BEFORE** turning on any electrical devices or starting the engine.
- Do not block fuel vents.
- Do not store fuel in any containers or compartments which are not designated for fuel storage and do not use these storage areas for any other purpose.
- Gas discharged by a fire extinguisher system displaces oxygen to smother the fire. If the fire

is in the engine compartment, do not open the hatch for at least 15 minutes after the fire extinguisher system operates. Oxygen from the open hatch can feed the fire and cause a flashback.

WARNING

Runaway Boat Hazard

The engine emergency stop switch and lanyard are extremely important safety devices that must always be used when operating the engine. These safety devices will prevent the boat from becoming a runaway if the operator is accidentally thrown from the seat or away from the helm.

Entanglement Hazard



Rotating or moving parts can entangle or sever body parts.

- Do not wear jewelry, unbuttoned cuffs, ties or loose-fitting clothing.
- Tie long hair back when working near moving or rotating parts such as the flywheel or propeller shaft.
- Keep hands, feet and tools away from all moving parts.
- Keep all guards in place when engine is operating.
- Use caution when working with ski or mooring lines so they do not become entangled with the propeller.

Exposure Hazard



Do not mix cleaning agents together; harmful vapors may be released. Read and follow safety-related precautions found on containers of hazardous substances like parts cleaners, primers, sealants and sealant removers.

Fire and Explosion Hazard



Hydrogen gases produced by a lead acid battery while it is charging, or the engine is running, can cause an explosion and/or a fire.

Gasoline is extremely flammable and highly explosive under certain conditions.



- Wear personal protective equipment when working on or around batteries.

WARNING

- Do not smoke or bring a flame near a battery.
- Do not check for a dead battery by placing a metal object between the battery posts. Sparks could cause an explosion.
- Do not place your head directly above a battery when making or breaking electrical connections.
- Charge the battery outside of your boat.
- Do not use a battery booster to start your engine.

Lifting Hazard

Special equipment is necessary to lift the boat and/or engine. Always use lifting equipment with sufficient capacity to lift the boat and/or engine.

Alcohol and Drug Hazard



Do not operate your boat while you are under the influence of alcohol or drugs or are feeling ill.

Exposure Hazard



Wear personal protective equipment, including appropriate clothing, gloves, work shoes, eye and hearing protection, as required by the current task.

CAUTION

The safety messages that follow have CAUTION level hazards.

These safety messages describe hazardous situations which, if not avoided, *could* result in minor or moderate injury.



Wear eye protection when servicing your boat or when using compressed air or high-pressure water. Dust, flying debris, compressed air, pressurized water or steam may injure your eyes.

Poor Lighting Hazard

Ensure that the work area is adequately illuminated. Install wire cages on portable safety lamps.

CAUTION

Tool Hazard

Use tools appropriate for the current task. Use the correct size tool for loosening or tightening machine parts.



Slip and Trip Hazard

Keep your boat free of water, oil, mud and other foreign matter. Remove anything that creates slippery areas around your boat.

NOTICE

The safety messages that follow have NOTICE level hazards.

These safety messages are used to address practices not related to personal injury.

Structural Hazard

Modifications may impair your boat's safety and performance characteristics and shorten the boat's life. Any alterations to your boat may void its warranty.

Environmental Hazard

ALWAYS be environmentally responsible. Follow the guidelines of the EPA or other governmental agencies for the proper disposal of hazardous materials such as engine oil and fuel. Consult the local authorities or reclamation facility.



CARBON MONOXIDE

DANGER! CO gas is colorless, odorless and extremely dangerous. All engines and fuel-burning appliances produce CO as exhaust. Direct and prolonged exposure to CO will cause brain damage or death. Even with the best boat design and construction, plus the utmost care in inspection, operation and maintenance, hazardous levels of CO may still be present in accommodation areas under certain



Section 2

conditions. To reduce CO accumulation, always provide adequate ventilation in the boat interior by opening the deck hatches, windows or canvas.

Always use a CO detector in confined areas where there is a possibility of CO buildup, such as sleeping quarters, galleys and head compartments. Regularly check the condition of the CO detector for proper operation.

WARNING! Always ensure adequate fresh air ventilation through your boat when underway.

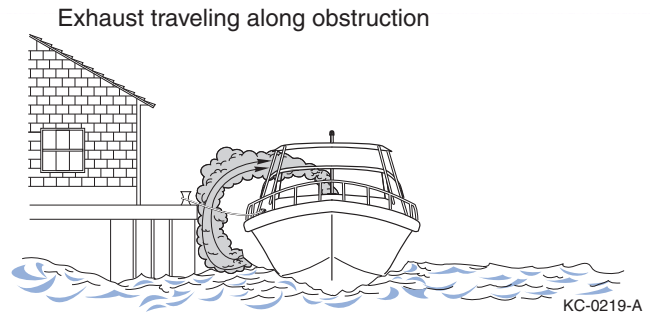

Figure 2-4

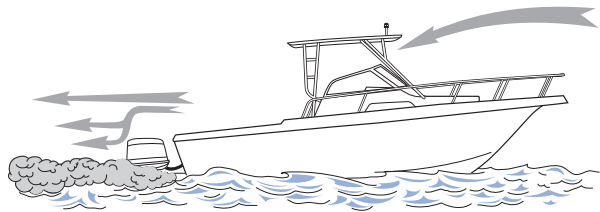

Figure 2-1

The following illustrations show some potential causes of CO poisoning while underway.

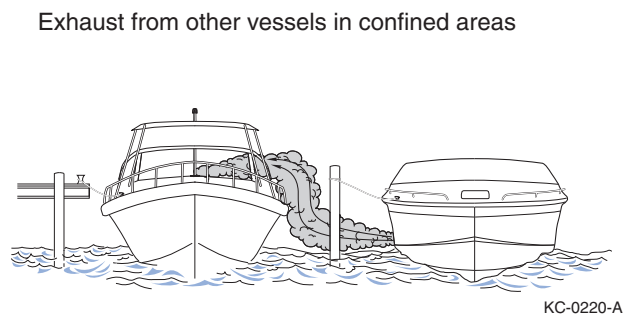

Figure 2-5

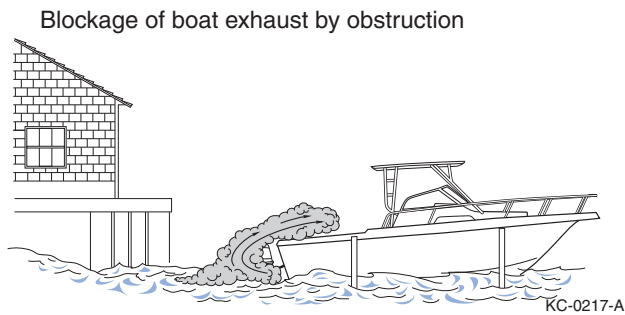

Figure 2-2

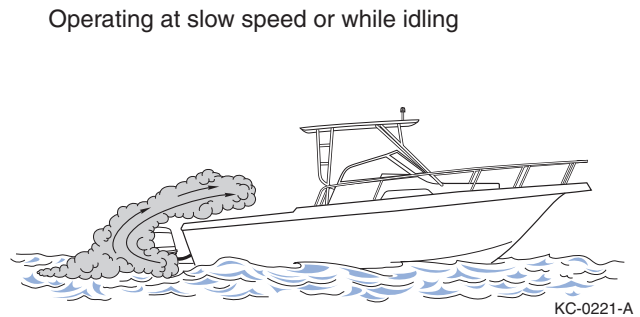

Figure 2-6

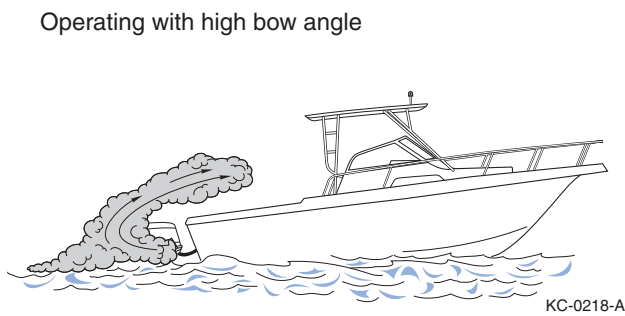

Figure 2-3

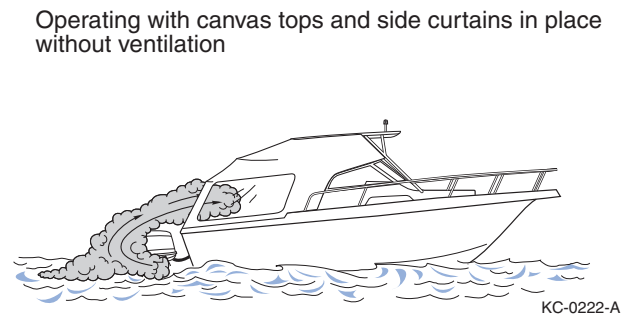

Figure 2-7



REQUIRED BOATING SAFETY EQUIPMENT AND REGULATIONS

U.S. Coast Guard Minimum On-Board Personal Safety Equipment Required

	Less than 16 ft (4.9 m)	CLASS 1: 16 to less than 26 ft (4.9 to less than 7.9 m)	CLASS 2: 26 to less than 40 ft (7.9 to less than 12.2 m)	CLASS 3: 40 to 65 ft (12.2 to 19.8 m)
LIFE JACKETS AND PERSONAL FLOTATION DEVICES	One Coast Guard-approved Type I, II, III or V wearable life jacket for each person on-board	One Coast Guard-approved Type I, II, III or V wearable life jacket for each person on-board and one throwable Type IV PFD device		
FIRE EXTINGUISHERS	One B-I type (Coast Guard-approved) If the vessel meets any one or more of the following conditions, the vessel must carry one B-I type USCG-approved extinguisher on-board: <ul style="list-style-type: none"> • Inboard/Sterndrive engine powered • Has closed compartments where portable fuel tanks can be stored • Has double bottom construction that has areas where air or gases can be open or trapped • Has an enclosed living space • Has compartments where flammable, combustible or explosive materials are stored • Has permanent fuel tanks installed • Vessel is 26 ft (7.9 m) or more in length 	One B-II OR two B-I type (USCG-approved) (A fixed extinguishing system is equal to one B-I.)	One B-II AND one B-I OR three B-I type (USCG-approved) (A fixed extinguishing system is equal to one B-I OR two B-II.)	
VISUAL DISTRESS SIGNALING DEVICES	One (1) electric distress light OR three (3) day and night combination red flares	One orange distress flag or one electric distress light OR three floating or handheld orange smoke signals and one electric distress light OR three day and night combination red flares, handheld, parachute or meteor type		
AUDIBLE DISTRESS SIGNALING DEVICES	A vessel less than 39.4 ft (12 m) must have on-board an efficient sound-producing device. (Example: hand or mouth whistle OR a compressed or powered air horn)	A vessel less than 39.4 ft (12 m) must have on-board an efficient sound-producing device. (Example: hand or mouth whistle OR a compressed or powered air horn) A vessel 39.4 ft (12 m) but less than 65.6 ft (20 m) in length operating in inland waterways must carry a power whistle OR powered air horn AND a bell		
NAVIGATION LIGHTS	Regulations require that navigational lights be clearly lit and properly displayed at all times between sunset and sunrise and always when operating in reduced visibility while boating			



Section 2

Fire Extinguisher

USCG-approved fire extinguishers are required on all Class I, II and III boats. Mount all handheld fire extinguishers in readily accessible areas away from the engine compartment and other combustible devices. All passengers must know the location and operating procedure of each extinguisher. Follow the manufacturer's instructions for proper use and operation of the fire extinguisher.

All fire extinguishers used on marine boats must be classified to extinguish type B fires (gasoline, oil or grease). The size and number of required fire extinguishers depend on the size of your boat. The two type B fire extinguishers commonly used are B-I and B-II. Type B fire extinguishers are classified by the different extinguishing compound amounts used in each.

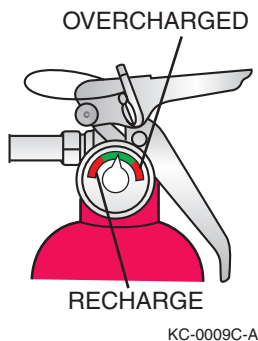

Figure 2-8

Check the fire extinguisher condition and pressure gauge regularly, if not before every trip, to ensure that the fire extinguisher is in good operating condition and is fully charged. If the fire extinguisher is damaged or not properly pressurized, replace it.

For specific on-board requirements, see *U.S. Coast Guard Minimum On-Board Personal Safety Equipment Required* on page 2-7.

Engine Emergency Stop Switch and Lanyard

The engine emergency stop switch is an extremely important safety precaution. Use the engine emergency stop switch when operating the boat's engine. This safety device prevents your boat from becoming a runaway if you are accidentally thrown from the seat or away from the helm.

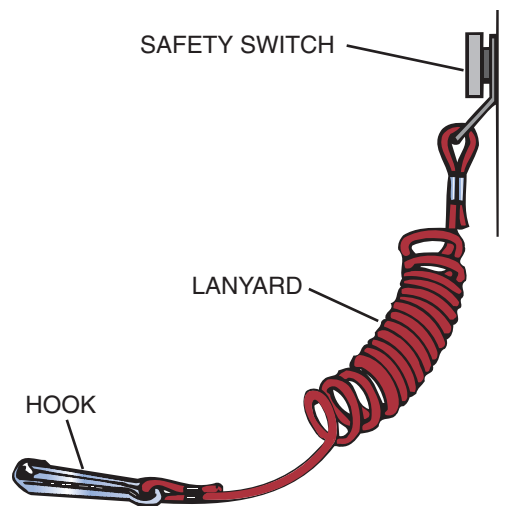

Figure 2-9

Before turning on the boat's engine, secure the engine emergency stop switch lanyard to the operator. If the operator is thrown from the seat or moves too far from the helm, the lanyard will disconnect from the switch, activating the switch to turn off the engine.

Never remove or modify the engine emergency stop switch and/or lanyard.

Always keep the lanyard free from obstructions that could interfere with its operation.

Always check the switch for proper operation. With the engine running, pull the lanyard. If the engine does not stop, have the switch repaired before continuing to operate your boat. Never operate your boat if the engine emergency stop switch does not work.



Life Jackets

All passengers on Class I, II and III boats must wear a USCG-approved Type I, II, III or V life jacket.

All Class I, II and III boats must have one USCG-approved Type IV throwable Personal Flotation Device (PFD) on-board.

Children and nonswimmers must always wear a life jacket when boating. All life jackets and PFDs must be in a readily accessible area and within immediate reach.

All passengers must know the location of the life jackets and how to wear and adjust them. Follow the manufacturer's instructions for proper use, care and operation of the life jacket.

Each USCG-approved life jacket on-board must:

- Clearly show the manufacturer's name
- Clearly show the USCG approval label and number
- Be an appropriate size and type for each person on-board
- Be in good, usable condition

Selecting the proper life jacket application type and size is important to your safety while boating. There are four application types of wearable PFDs and one type that is used only for throwing in emergency situations. Life jackets may include inherently buoyant designs (do not require inflation) or inflatable (manual and manual with automatic backup). Life jacket sizes generally correspond to chest size and weight.

Type I

This life jacket is designed so that the person wearing it turns to a face-up position when conscious or unconscious. Type I life jackets are the most buoyant and are effective on all waters, especially when rescue is delayed or flotation time is extended.

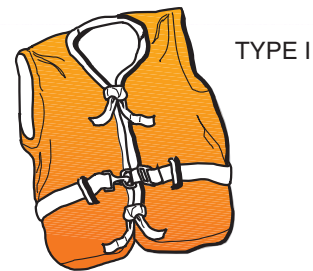

Figure 2-10

Type II

This life jacket is recommended for use in calm water near shore on most inland waters where quick rescue is likely. A Type II life jacket is similar to a Type I life jacket, but is not as buoyant or effective in turning the wearer to a face-up position.

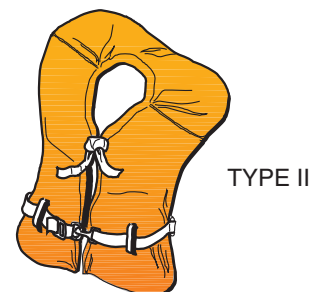

Figure 2-11

Type III

This life jacket is designed for personal buoyancy when the wearer is alert and conscious. Type III life jackets require users to turn themselves to a face-up position. Type III life jackets are recommended in most inland water applications where quick rescue is likely or when used in the presence of other people.

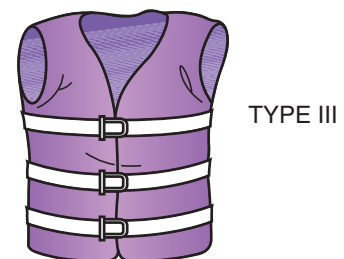

Figure 2-12



Section 2

Type IV

These PFDs are designed to be thrown to a person in the water who can grab and hold it while being rescued. Never wear a Type IV PFD.

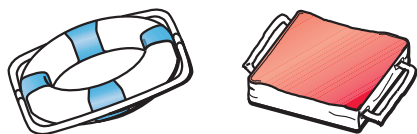

TYPE IV

KC-0007C-A

Figure 2-13

Type V

This life jacket is designed for special activities and may be worn instead of a Type I, II or III life jacket if used in accordance with the approval conditions on the label. If a Type V life jacket is part of the minimum on-board life jacket requirements and if it has a label that indicates “required to be worn,” it must be worn at all times, otherwise one additional Type I, II or III life jacket must be on-board to satisfy the minimum life jacket requirements. Some Type V life jackets provide increased protection against hypothermia.



TYPE V

KC-0005C-A

Figure 2-14

Other special life jackets are available for skiing and other water sports. These life jackets are constructed with materials suitable for high-impact falls. When selecting these life jackets, ensure that they meet USCG approval requirements.

Note: Inflatable USCG-approved life jackets are not to be used by persons under the age of 16.

Children’s Life Jackets

All life jackets are clearly labeled with the appropriate weight range. Check the label to match the weight range of your child. To check for a good fit, pick the child up by the shoulders of the life jacket. If the life jacket fits, the child’s chin and ears will not slip through.

Children weighing between 30 and 50 pounds may like the freedom of movement that a Type III life jacket provides; however, a Type I or Type II life jacket will usually offer greater protection for most children in this weight range, especially those who cannot swim.

- Use a life jacket with a collar that turns a child’s face up in the water. It must have strong straps and buckles, a handle on the collar and, preferably, be bright yellow or orange in color for high visibility.
- Attach a plastic safety whistle to the life jacket. Teach the child how to use the whistle, and practice using it and signaling for help.

Note: Inflatable USCG-approved life jackets are not to be used by persons under the age of 16.

Visual Distress Signaling Devices

Boats less than 16 feet (4.9 meters) must have USCG-approved Visual Distress Signals (VDS) on-board when operating between sunrise and sunset in coastal waters, including ocean bays, gulfs and sounds, as well as the Great Lakes, seas, bays and river mouths that are 2 or more miles wide and only to the point proceeding inland where the water narrows to less than 2 miles. Visit the U.S. Coast Guard website for additional information on specific VDS requirements for your boat.

Ensure all passengers on-board understand how to operate all VDS. Keep VDS in a readily accessible area and within immediate reach at all times when boating.

Regulations prohibit using pyrotechnic VDS or any VDS in non-emergency situations.

VDS must be:

- USCG-approved
- In proper operating condition



- Safely stowed and readily available
- Within the clearly marked expiration date stamp on the device (where applicable)

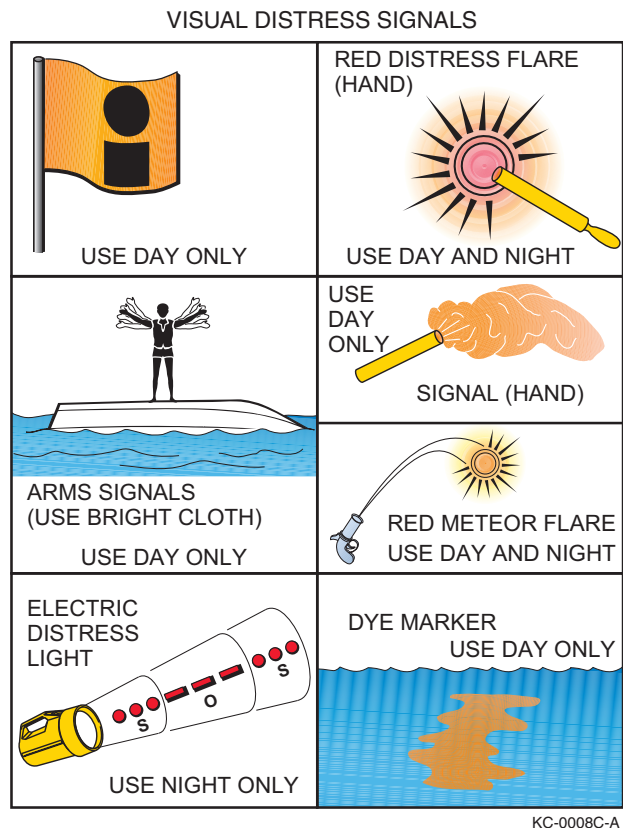

Figure 2-15

Types of VDS vary by emergency situation. VDS are classified as either pyrotechnic or non-pyrotechnic.

Note: Some pyrotechnics may be restricted on certain bodies of water. Check with local authorities, or visit the National Association of State Boating Law Administrators (NASBLA) website: <http://www.nasbla.org> or the U.S. Coast Guard website: <http://www.uscg.mil> for additional information.

For specific on-board requirements, see *U.S. Coast Guard Minimum On-Board Personal Safety Equipment Required* on page 2-7.

Audible Distress Signaling Devices

Audible (sound) distress signals are required to be on-board all boats. A boat less than 39.4 feet (12 meters) must always have an efficient sound-producing device on-board (Example: hand or mouth whistle, or a compressed or powered air horn).

A boat at least 39.4 feet (12 meters) but less than 65.6 feet (20 meters) operating in inland waterways must always have a power whistle or powered air horn and a bell on-board.

All devices must be acceptable for use in marine environments, audible for 1/2 nautical mile and maintain a continuous four- to six-second sound duration. The diameter of the bell's mouth must be a minimum of 7.9 inches (20.0 centimeters).

Ensure all passengers understand how to operate all audible distress signaling devices on-board. Keep these devices in a readily accessible area and within immediate reach at all times when boating.

For specific on-board requirements, see *U.S. Coast Guard Minimum On-Board Personal Safety Equipment Required* on page 2-7 and for usage information, see *Audible Distress Signals* on page 6-2.

Navigational Lights

Navigational lights are intended to alert other boats to your presence and course.

Regulations require that navigational lights be clearly lit and properly displayed at all times between sunset and sunrise, and always when operating in reduced visibility. The placement, shape and visibility requirements of navigational lights may vary depending on usage. Check with local authorities, or visit the NASBLA or U.S. Coast Guard website for additional information.

For additional information, see *Navigational Lights and Night Operation* on page 6-2.



Section 2

RECOMMENDED SAFETY EQUIPMENT

Carry and know how to use the following equipment in addition to the required equipment on-board at all times as an extra safety precaution:

- Anchor and line with minimum 75 feet (23 meters) of line
- Auxiliary starting battery
- Boat hook
- Cellular phone
- Compass
- Dock fenders
- Duct and electrical tape
- Electrical wire
- Emergency food and water
- Emergency Position Indicating Radio Beacon (EPIRB)
- Engine lubricant
- Extra drain plug
- Extra keys
- First aid kit and manual
- Flashlight
- Flashlight and radio batteries
- Foul weather gear/clothing
- Fuses
- GPS Global Positioning Device
- Insect repellent
- Local charts and compass
- Mooring lines
- Navigational and interior light bulbs
- Oar/paddles
- Propeller, nut and washer
- Radio
- Spark plugs
- Sunglasses and sun block
- Thermal clothing
- Tool kit including propeller replacement tools
- Tow line
- VHF-FM/AM with weather band radio
- Waterproof flashlight

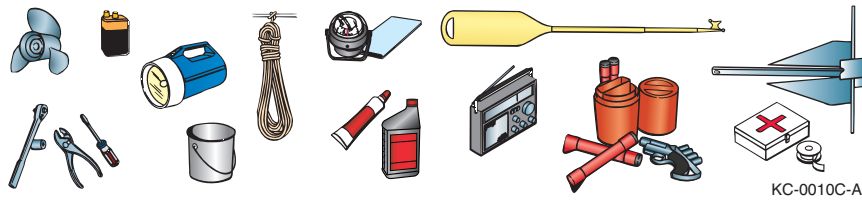

Figure 2-16



WATER SPORTS SAFETY

Some boats are not designed or recommended to be used for water sports. Use boats equipped with a ski-tow eye or other specially designed line attachment device to pull persons or equipment engaged in a water sport. **DANGER! It is unlawful to participate in water sports while under the influence of alcohol or other drugs.**

Water sports may include, but are not limited to, any activity performed in the water such as swimming, diving, snorkeling, knee boarding, tubing, skiing, parasailing, kiting, gliding or any activity using a device that may be pulled or pushed by a boat.

Check with local and state authorities or water sports clubs and affiliations for additional information.

Platform Dragging

Every year tragic deaths occur from the negligence of unsafe boating and dangerous activities. **NOTICE: It is UNLAWFUL to be on or holding on to the boarding platform, swim deck, swim step, swim ladder or any portion of the exterior of the transom at any time while the boat is running or under way in any direction and at any speed.**

WARNING! Body, teak or platform dragging is extremely dangerous and can be fatal. Never hold on to the transom of a boat while in the water when the boat is running or under way.

- Do not use the boarding platform or ladder for any purpose other than boarding the boat or entering the water.
- Do not use the boarding platform or ladder while the engine is running.
- Do not swim under the boarding platform when the engine is running.

These dangerous and even fatal activities can lead to any or all of the following, as well as other dangers not listed here:

- Carbon monoxide poisoning
- Severe injury from a rotating propeller
- Drowning or entrapment under the water

Water Sports Guidelines

The following water sports guidelines only cover the general conditions that frequently arise. The participants must respond to the constantly changing weather and the conditions of the sea by using reasonable and safe judgment in light of the circumstances.

Boat Operator, Occupants and Participants

- Always be safe and courteous. Be considerate to fishermen and all others with whom you share the water.
- Always ensure that all water sports participants and occupants of the boat, especially the operator, are fully aware at all times of the participants' condition and location in the water, as well as the surrounding environment.
- Make safety the primary concern of all involved during the activity. Only allow safe and capable participants to engage in the activity.
- The boat operator and water sports participants must always know their limitations in the activity and never exceed them.
- Never perform water sports in or near:
 - Congested areas
 - Restricted areas
 - Navigation or other waterway markers
 - Other boats
 - Other water sports participants
 - Obstructions in the water
 - Shorelines
 - Shallow water
 - Hazardous weather conditions
 - Hazardous waterways, rapid moving water, dams, spillways, etc.
 - Areas or times of restricted visibility
 - Hours between sunset and sunrise
 - Locations too far from shore that could hinder immediate rescue or emergency help if needed
- Always engage in water sports activities in safe waterways only.
- Always attach the water sports tow rope to approved attachment points on your boat.
- Never jump from a boat that is moving at any speed, and do not enter or exit the water when the engine is running.



Section 2

- Never use different length ropes simultaneously for water sports activities.
- Always make sure that participants know and use approved skiing hand signals and common skiing courtesy.
- Before starting, always agree to speed and communication hand signals between the boat operator, spotter/observer and participants.
- Before starting, always inspect the water sports equipment and tow eye, tow point and towline for safe operating condition, or damage that may lead to failure.

Boat Operator Specific Guidelines

The following guidelines are for the boat operator while a participant is in the water.

- Always have a “spotter” (designated observer) other than the boat operator on-board to ensure the safety of the participants in the water and provide communication to and from the boat operator and the participants.
- Always turn the engine off from a safe distance when approaching participants in the water and allow them to reach the boat. Never run the engine near a person in the water.
- Never operate your boat in reverse to retrieve anyone in the water.
- Always return immediately to a fallen water sports participant. Always approach the participant on the operator’s side while keeping the participant in view from a direction opposite the wind or seas.
- Never drive directly at a person in the water or directly behind another boat.
- Always maintain a safe distance from people and objects in and on the water.
- Always look in the direction you plan to turn before turning your boat to pick up a fallen skier.
- Never retrieve any object from the water while the engine is running.
- Always keep the skier in view when the skier is entering or exiting the boat.
- Always watch the skier as the line begins to tighten (in case the rope wraps around ski or skier).
- Always look ahead before starting.
- Always start from a safe place with good forward and peripheral visibility.

- Always check direction of steering before starting, ensuring that your boat steers straight.
- Always be aware of what is occurring in front of your boat, and of a participant’s condition.
- Always display a “skier down” flag whenever a skier is in the water and not skiing.
- Always follow the approved towing pattern for the waterway in which you are operating.

Additional Guidelines for Participants in the Water

The following guidelines are for the water sports participant.

- Never participate in water sports if you cannot swim.
- Always wear a bright-colored USCG-approved activity PFD at all times. Wear suitable protective clothing or gear and/or a wet suit to prevent impact injuries, abrasions and hypothermia.
- Never approach or enter the boat if the engine is running.
- Always avoid the boat’s propeller. Even when the propeller is not rotating, its sharp edges can cause serious injury.
- Never put any part of your body through the handle of the ski line or wrap the line around any part of your body.
- Never enter the water from a boat that is running or moving at any speed.
- Always indicate that you are clear of the boat prior to the operator starting the boat or putting the boat into gear and tightening the rope.



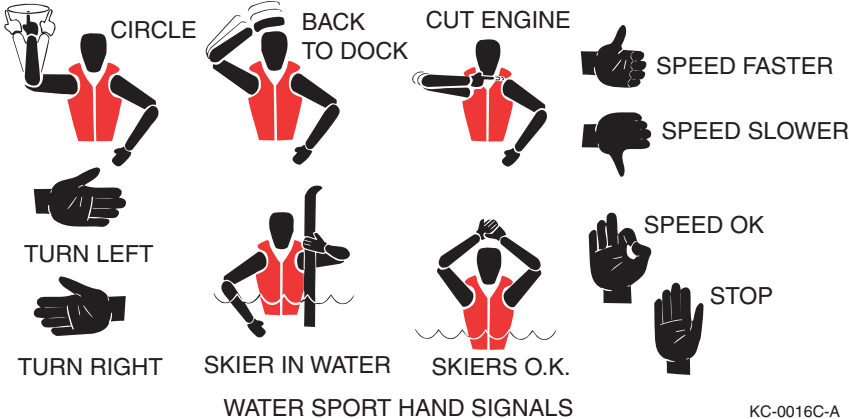

Figure 2-17



Section 2

This Page Intentionally Left Blank



Section 3

BOATING REGULATIONS AND YOUR RESPONSIBILITIES

The U.S. Coast Guard (USCG) is the federal authority on U.S. coastal and inland waterways, but state and local regulations may exist that exceed USCG regulations. The purpose of all of these regulations is to assist the boating public and maintain navigational order on waterways.

Many state equipment requirements go beyond USCG requirements. Contact your state and local boating authorities for further information. Equipment requirements for coastal and inland waters differ. Check with local authorities or the USCG for further information about coastal water requirements.

Boating regulations are enforced by USCG, state and local authorities. You are subject to marine navigation regulations for both federal and state waterways. You must comply if enforcement officers signal you to stop your boat or if they ask to board your boat.

Many USCG, state and local resources are available to you. For additional and current information on regulations, safety and navigation, contact your local USCG unit or local marine authority.

See *References and Contact Information on page 1-4* for a list of resources.

BOAT OWNER / OPERATOR RESPONSIBILITIES

As a boat owner/operator, understand and be aware of USCG federal regulations as well as state and local regulations where you operate your boat. Boating regulations include, but are not limited to, boat regulations, boat equipment regulations and navigational regulations.

You must have on-board at all times all mandatory safety and boat equipment as regulated by the governing authorities. All equipment must be maintained in proper working order.

SAFETY

As a boat owner/operator, you are legally responsible for your safety, the safety of your passengers and the safety of other boaters. In addition, you are responsible for the operation and navigation of your boat under all operating conditions. Your boat must be in compliance with USCG safety equipment regulations.

REGISTRATION

The USCG requires that all power boats operated on the navigable waters of the United States be currently registered in the state in which they are principally used. Many states require current registration in that state whenever boating on waters within their state boundary. Always contact your state boating authorities (and authorities in neighboring states) for registration information on boats and trailers.

Registration numbers must be current and clearly displayed on the boat according to the defined regulations. Registration certificates must be current and on-board at all times.

State and local authorities may require additional registration for boating on certain waterways. Check with state and local authorities for additional registration information.

For more information visit:

- U.S. Coast Guard Office of Boating Safety:
<http://www.uscgboating.org>
- National Association of State Boating Law:
<http://www.nasbla.org>



Section 3

INSURANCE

As a boat owner, you are legally responsible for any damage or injury caused when you or someone else is operating your boat when an accident or collision occurs. Individual states have laws detailing minimum insurance needs. Contact your insurance agent to verify the type of insurance you need BEFORE operating your new boat.

REPORTING ACCIDENTS

The USCG requires the owner/operator of a boat involved in an accident to report the incident to the proper marine law enforcement agency for the state in which the accident occurred. If a person dies or disappears as a result of a recreational boating accident, the boat owner/operator must immediately notify the nearest state boating authority. If a person dies or injuries requiring more than first aid are involved, the owner/operator must file a formal report within 48 hours of the accident. An owner/operator has 10 days to file a formal report for accidents exceeding \$500 in property damage or complete loss of boat.

OPERATION BY MINORS

Minors must always be supervised by an adult whenever operating a boat. Many states have laws regarding the minimum age and licensing requirements of minors. Regulations may vary from state to state. Contact your local and state boating authorities for specific information.

BOATING UNDER THE INFLUENCE

Federal and state laws prohibit the operation of a boat while under the influence of alcohol or drugs, and authorities actively enforce these regulations. If the operator's blood alcohol content is 0.08% or above, violators are subject to civil and criminal penalties and imprisonment. Operating a boat under the influence can also result in a loss of motor vehicle driving privileges.

Alcohol and drugs slow your reaction time and affect your judgment. This type of impaired operation may result in death or severe personal injury.

As the owner/operator, you are responsible for the alcohol and drug use, as well as on-board behavior, of your passengers.

Regulations and penalties for operators and passengers may vary from state to state. Contact your local and state boating authorities for specific information.



KC-0011C-A

Figure 3-1

OPERATOR'S LICENSE AND EDUCATION

This manual does not provide complete training on all aspects of boating safety, operation or regulations. Boating authorities highly recommend that all boat operators and passengers seek additional training in boating safety and seamanship from a USCG-approved course.

Some states require youths 16 years of age and younger to complete a boating safety course before operating any watercraft. Many others require operators under the age of 18 to be licensed in small boat operation.

Check with your state and local authorities for requirements of operator's license, certificate or training before you or anyone operates your boat.

See *References and Contact Information* on page 1-4 for a list of some of the agencies and organizations that offer water/boating safety courses, first aid/CPR, or other recommended training and/or information.



Boating Regulations and Your Responsibilities

EMERGENCY ASSISTANCE

If you see a distress signal or suspect a boat is in trouble, you must assume it is a real emergency and render assistance immediately. By law, the operator in charge of the boat is obligated to provide assistance to any individual in danger if such assistance can be provided safely. Failure to render assistance can result in a fine and/or imprisonment. The 1971 Boating Safety Act grants protection to a "Good Samaritan" boater providing good faith assistance, and absolves a boater from any civil liability arising from such assistance.

PROTECTING THE ENVIRONMENT

As a boat owner/operator, you are responsible for protecting wildlife and the natural environment by keeping waterways clean. There is currently a tremendous drain on our natural resources. Excessive fishing and hunting, as well as pollution, have strained the fish and game population. Do your part by keeping only what you will eat; practice catch-and-release and obey bag limits.

FISHING

Fishing can be very exciting and distracting for the operator when the action gets intense. You must always be conscious of the fact that your primary responsibility is the safe operation of your boat and the safety of your passengers and other boats in the area.

You must always make sure the helm is properly manned and is never left unattended while trolling. If your boat is equipped with a tower, caution and good common sense must be exercised whenever someone is in the tower. Remember, weight in the tower raises your boat's center of gravity and your boat's motion is greatly exaggerated for the person in a tower.

If you are fishing in an area that is crowded with other fishing boats, it may be difficult to follow the rules of the road. This situation can become especially difficult when many boats are trolling.

Being courteous and exercising good common sense is essential. Avoid trying to assert your right-of-way and concentrate on staying clear and preventing tangled or cut lines and other unpleasant encounters with other boats. Also keep in mind that fishing line wrapped around a propeller shaft can damage seals in the engine lower unit.

FOREIGN SPECIES TRANSPORTATION

If you trailer your boat from lake to lake, you may unknowingly introduce a foreign aquatic species from one lake to the next. Thoroughly clean your boat below the waterline, remove all weeds and algae, and drain the bilge and livewells before launching your boat in a new body of water.

WAKE

As a boat owner/operator, you are responsible for the wake your boat creates. Regulations may vary from state to state. Contact your local and state boating authorities for specific information, as you may be responsible for any damage or injury your wake causes. Always be alert for NO WAKE zones and be courteous of others while boating. Excessive and unexpected wakes can cause dangerous and even life-threatening situations.

NOISE

As a boat owner/operator, you are responsible for the noise your boat creates. Many state and local boating authorities enforce noise limits that may restrict engine noise, radio volume or even loud talking. Regulations may vary from state to state. Contact your local and state boating authorities for specific information.

SPEED

As a boat owner/operator, you are responsible for maintaining your boat under control at a safe speed. Many state and local boating authorities enforce speed limits. Regulations may vary from state to state. Contact your local and state boating authorities for specific information.



Section 3

POLLUTION REGULATIONS

The discharge of any type of debris or waste into the water, including, but not limited to, food, trash, garbage, oil, fuel, liquids and human waste, is highly restricted and sometimes considered unlawful. Authorities highly recommend that you NEVER discharge anything into the water.

Become familiar with the following pollution regulations. Pollution is a serious matter, and law enforcement authorities highly enforce these regulations. As a boat owner/operator, you are responsible for your actions affecting the environment; therefore, you must fully understand and be aware of these regulations. Contact the USCG, state and local authorities for additional information.

MARPOL Treaty

The USCG enforces the International Convention for the Prevention of Pollution from ships, commonly referred to as the MARPOL Treaty (MARine POLLution). This treaty prohibits the overboard dumping of all ship-generated plastics, chemicals, garbage and oil. Contact the USCG for further information.

Refuse Act of 1899

The Refuse Act of 1899 prohibits throwing, discharging or depositing refuse matter of any kind (including food, trash, garbage, oil and other liquid pollutants) into U.S. waterways.

Federal Oil Pollution Act of 1990

The Federal Oil Pollution Act of 1990 was passed by Congress to prevent further oil spills from occurring in the U.S. As a boat owner, be familiar with your liability under this act, as you may be liable for the cost of actions in the prevention and/or removal of, or damage from, oil spills created by you.

Federal Water Pollution Control Act

The Federal Water Pollution Control Act prohibits the discharge of oil or hazardous, potentially harmful substances into U.S. navigable waters. Boats at least 26 feet (7.9 meters) in length must display a placard at least 5 x 8 inches (127 x 203 mm), made of durable material, fixed in a conspicuous place in the machinery spaces, or at the bilge pump control station, stating the following:

Discharge of Oil Prohibited

The Federal Water Pollution Control Act prohibits the discharge of oil or oily waste upon or into any navigable waters of the U.S. The prohibition includes any discharge which causes a film or discoloration of the surface of the water or causes a sludge or emulsion beneath the surface of the water. Violators are subject to substantial civil and/or criminal sanctions including fines and imprisonment.

Paints

As a boat owner, you are responsible for the environmental regulations that may govern the use of antifouling paint. If your boat is kept in water where marine growth is a problem, the use of antifouling paint may reduce the growth rate. Regulations may vary from state to state. Contact your local and state boating authorities for specific information.

Cleaning Agents

As a boat owner, you are responsible for the environmental regulations that may govern the use of cleaning agents. Use household cleaners sparingly and never discharge them into waterways. Do not mix cleaners and be sure to use plenty of ventilation in enclosed areas. Avoid using chlorine, solvents and products that contain phosphates, as well as non-biodegradable or petroleum-based products. Regulations may vary from state to state. Contact your local and state boating authorities for specific information.



Boating Regulations and Your Responsibilities

Exhaust Emissions

As a boat owner, you are responsible for the exhaust emissions from your boat. Increased exhaust (hydrocarbon) emissions, which are regulated by the EPA, pollute the water and air. Contact your dealer and the engine manufacturer for more information. Additional restrictions may apply and vary from state to state. Contact your local and state boating authorities for specific information.

Proposition 65

A wide variety of components used on this vessel contain or emit chemicals known to the state of California to cause cancer, birth defects and other reproductive harm.

Examples include:

- Engine and generator exhaust
- Engine and generator fuel and other liquids, such as coolants and oil, especially used motor oil
- Cooking fuels
- Cleaners, paints and substances used for vessel repair
- Waste materials that result from wear of vessel components
- Lead from battery terminals and from other sources, such as ballast or fishing sinkers

To avoid harm:

- Keep away from engine, generator and cooking fuel exhaust fumes.
- Wash areas thoroughly with soap and water after handling the substances above.

⚠ WARNING

A wide variety of components used on this vessel contain or emit chemicals known to the State of California to cause cancer and birth defects and other reproductive harm.

EXAMPLES INCLUDE:

- Engine and generator exhaust
- Engine and generator fuel, and other liquids such as coolants and oil, especially used motor oil.
- Cooking fuels.
- Cleaners, paints, and substances used for vessel repair.
- Waste materials that result from wear of vessel components.
- Lead from battery terminals and from other sources such as ballast or fishing sinkers.

TO AVOID HARM:

- Keep away from engine, generator, and cooking fuel exhaust fumes.
- Wash areas thoroughly with soap and water after handling the substances above.

California Health & Safety Code §§ 25249.5-.13

KC-0206C-A

Figure 3-2



Section 3

State of California Requirements

Your boat may be equipped with an engine that meets the strict requirements outlined by the California Air Resources Board (CARB). If so, the engine has a special environmental tag and the boat has one of the following labels affixed to it. The tag and the label are required by CARB. The label has 1, 2, 3 or 4 stars and **must** be affixed to your boat if it is operated in the state of California and/or bordering waters. For more information visit: <http://www.arb.ca.gov>.



KC-0211-B

Figure 3-3



Section 4

EMERGENCIES

Be prepared to deal with emergencies before they happen. Try to formulate a plan for each type of emergency in advance so you can make decisions quickly and without hesitation. Precious moments lost can mean the difference between losing and saving a life.

Before operating your boat, see *Safety on page 2-1*.

FIRST AID / MEDICAL EMERGENCIES

Every second counts toward preventing injury or death in case of a medical emergency. Boaters must have proper training and take necessary preventive measures to properly assist in times of need. Carrying an adequate and current first aid kit is critical in the immediate response and care of someone in need of medical attention. Always have dry blankets readily accessible to help prevent hypothermia. For additional information on medical, first aid and safety training such as CPR, contact your state and local authorities, or visit the Red Cross website:

<http://www.redcross.org>

EMERGENCY PREPARATION CHECKLIST

In addition to a safety equipment list, have an emergency checklist on-board to assist in times of emergency. Use the following topics as a guideline to develop a list of emergency procedures and instructions for the use of visual and audible distress signaling devices, radios, first aid kits and all related information that could assist you or others in the event of an emergency.

CARBON MONOXIDE POISONING

DANGER! Carbon Monoxide (CO) is a colorless and odorless gas produced by all engines, fuel-burning appliances, and any material that contains carbon and is burned.

Do not confuse carbon monoxide poisoning with seasickness, intoxication or heat stress. If someone complains of irritated eyes, headache, nausea, weakness, dizziness or drowsiness, or you suspect carbon monoxide poisoning, immediately move the person to fresh air, investigate the cause and take corrective action. Seek medical attention if necessary.

For additional information, see *Carbon Monoxide on page 2-10*.

USING DISTRESS SIGNAL DEVICES AND CALLING FOR HELP

Ensure all passengers understand how to operate all on-board visual and audible distress signaling devices and communication equipment. Keep all distress signaling devices and communication equipment in a readily accessible area and within immediate reach at all times.

An emergency can occur when you least expect it. Be sure you and your passengers know how to use all types of distress signaling devices. Seconds count during emergencies. Knowing the proper way to use the distress signaling devices on-board your vessel can help save lives.

The word "MAYDAY" is the international signal of distress. Use "MAYDAY" only in emergency situations.

In emergency situations and when lives are in danger, you may need to use VHF-type two-way radios, cell phones and Emergency Position Indication Radio Beacons (EPIRBs). Knowing the proper use and operation of these communication



Section 4

devices is critical. Make sure you know what channels to use and numbers to call. Know how to send an efficient and informative message about your emergency to ensure that proper help and assistance can be provided.

The VHF-type radio channel commonly used for communicating distress, safety and urgent calls is Channel 16.

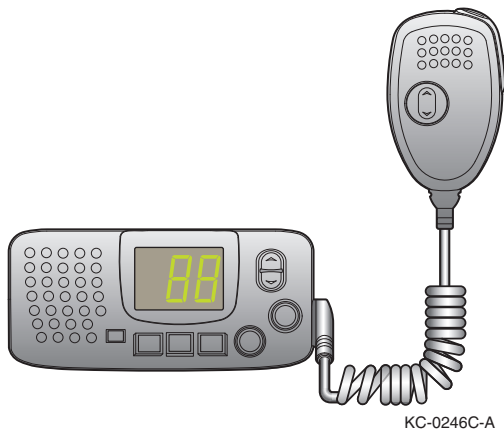

Figure 4-1

To contact the USCG for an emergency while on the water, always use your on-board VHF-FM radio (Channel 16). Use cell phones only as a secondary means of communication. The number to call within the U.S. is 911.

For additional information on the safe and proper use of distress signaling devices and the safe and proper use of emergency communication equipment, contact your state and local authorities. Additional information can be found on the USCG website:

<http://www.uscgboating.org>.

FIRE AND EXPLOSION

DANGER! Gasoline is extremely flammable and highly explosive under certain conditions.

- Do not smoke or allow open flames or sparks nearby when refueling.
- Do not store fuel in any containers or compartments which are not designated for fuel storage.
- Static electricity can be generated while fueling and can cause a fire or explosion. To prevent electrostatic spark when refueling, make sure the nozzle is in contact with the fill pipe at all times.
- Avoid damaging fuel lines and connectors and make sure fuel does not contact hot engine parts.
- Do not confuse the fuel fill deck plate with the water or waste fill plates, if equipped. All deck plates are properly labeled. If fuel is accidentally pumped into any other deck plate, do not attempt to pump it out yourself. Water and waste pumps are not designed to pump fuel and a fire or explosion could result. Contact your dealer to have the fuel professionally removed.
- USCG-approved fire extinguishers are required on all Class I, II and III boats.

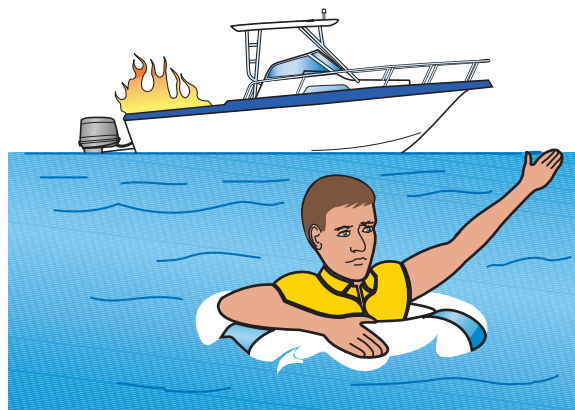

Figure 4-2

A fire or explosion may occur when you least expect it. Your decision regarding whether to abandon your boat or stay to fight the fire is difficult and depends on many factors. Formulate



a fire plan in advance to make that decision quickly and without hesitation. Keep in mind the following guidelines:

- Many fires are the result of gasoline and oil accumulating in the bilge, careless fueling practices and electrical problems. In the event of a fire, try to stop your boat and turn off the engine as quickly and safely as possible. Immediately use a fire extinguisher at the base of the flames in a sweeping motion to reduce or extinguish the fire. Ensure that all passengers are safe from immediate danger and are wearing PFDs. If the fire is located in the engine compartment (if equipped), make sure the bilge blower (if equipped) is off and do not open the engine cover.
- Once you have extinguished the fire, check for other immediate fire threats and personal injuries and call for assistance immediately.
- If you are unable to easily extinguish the fire, or if the fire is uncontrollable, attempt to get yourself and all passengers off your boat and into the water. If possible, ensure that all passengers are wearing PFDs or have access to one by the time they are in the water. Before leaving the boat, if possible, verify that there is no immediate danger of fuel sitting or burning on the water's surface where you and your passengers will be floating. Immediately swim to a safe position upwind from your boat and use distress signals to get assistance.

MAN OVERBOARD

If someone falls into the water unexpectedly, use the following guidelines. Every second counts toward preventing injury or death.

At the first sign that a person has fallen overboard, loudly yell "Man overboard!" and state the position of the person in relation to the boat (Example: "Man overboard - port!").

Set the engine throttles at idle and place the gear controls in the NEUTRAL position immediately.

Throw a Type IV PFD to the victim immediately if the PFD will be within reach of the victim. If the victim is too far away to throw a PFD to, navigate back and throw the PFD from a safe distance. If a Type IV PFD is not readily available, any life jacket or floating device will suffice.

Someone in your boat must keep the victim in sight at all times. It is the captain's responsibility to assign one person to watch the victim.

Carefully navigate back to the victim, staying at a safe distance and position to safely retrieve the victim.

Avoid going into the water to assist the victim unless there is absolutely no way to retrieve the victim safely from your boat and there is no chance of endangering others.



Section 4

CAPSIZING AND FLOODING

A boat may capsize or flood when you least expect it. Formulate a plan in advance in case of capsizing or flooding. Review the following guidelines:

- If your boat capsizes, locate all passengers and guide them to a safe flotation device or the forward hull if your boat is floating upside down.
- If possible, provide life jackets to all persons in the water and assess them for alertness and injuries.
- **STAY WITH THE BOAT!** Climb up on the hull and try to get assistance.
- Do not try to swim to shore, as it can be farther than it appears.

If your boat starts to flood, slow the boat to a safe speed and stop as quickly as possible. Activate the bilge pump(s) immediately. Try to locate the cause of the flooding. If the cause is not readily apparent or not easily corrected, head for shore or shallow water as quickly as possible and call for help.

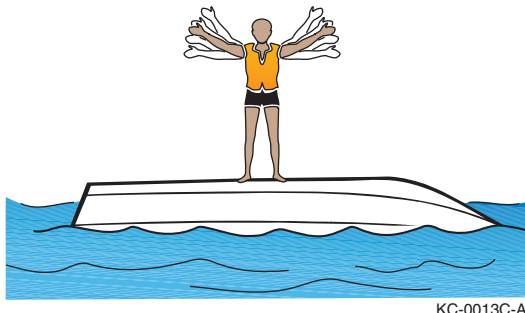

Figure 4-3

RUNNING AGROUND

When a boat runs aground, the stop is usually abrupt. Because passengers are not secured to a seat, abruptly stopping a boat while in motion can cause serious personal injury or even death. First, turn off the engine(s) immediately, locate all passengers and attend to any injuries, calling for emergency assistance as needed. Then, assess the damage to your boat and determine if there are any other immediate threats such as water leaking into your boat, or fuel or flammable materials leaking into the water or inside your

boat. Immediately call for assistance if threats exist that could endanger the safety of passengers.

If there are no immediate safety threats to passengers and your boat is not damaged, attempt to propel it away from the obstacle. If the engine or drive system has been damaged and the engine restarts, be aware of excessive vibrations or uncommon noises, which usually indicate damage to the drive system. If this is the case, it is not safe to proceed. Call for emergency or professional towing assistance immediately.

WARNING! Use extreme caution when using tow lines and when connecting tow lines to cleats. Death or serious injury could occur when lines and/or cleats fail while they are under extreme tension.

If the engine restarts and your boat can be navigated back safely to port, proceed slowly back to port and be ready to call for emergency assistance if needed. Even if your boat and engine appear to be in good operating condition after running aground, have the boat inspected by a qualified marine technician BEFORE returning it to service. Damage may have occurred that is not obvious to you as an operator.

DANGEROUS WEATHER

Take special precautions when encountering or operating in dangerous or hazardous weather conditions.

For additional information, see *Severe Weather* on page 5-1.

ENGINE OR BOAT SYSTEM FAILURE

In the event of an engine or boat system failure and when not in immediate danger, try to troubleshoot or identify the problem before calling for assistance.

For additional information, see *Troubleshooting* on page 12-1.



ACCIDENTS, COLLISIONS AND GIVING ASSISTANCE

A collision or accident may occur when you least expect it. Formulate a course of action in advance in case of a collision or accident. Keep in mind the following guidelines:

- If an accident or collision occurs involving your boat, locate all passengers first and verify and secure their safety. Check for injuries and provide all passengers with a flotation device.
- Once you have determined that your passengers are not in danger, provide assistance to passengers on the other boat.
- Immediately call for help and then assess the damage to the boats. Render necessary assistance to prevent further damage or personal injury.

The USCG requires the owner/operator of a boat involved in an accident to report the incident immediately to the proper marine law enforcement agency for the state in which the accident occurred.

If you witness or are aware of an accident or collision while boating, you must report it immediately and provide assistance.

If you see a distress signal or suspect a boat is in trouble, you must assume it is a real emergency and render assistance immediately. Once you have determined that a real emergency exists, call for help immediately and then provide assistance to all passengers to ensure their safety.

TOWING ON THE WATER

If you encounter a situation where you are asked to tow or be towed for any reason, assess the situation and try to contact a professional towing service or other emergency assistance first. When encountering a boat in distress, always offer emergency or safety assistance and/or call for assistance for the distressed parties if necessary. Towing or being towed presents an increased risk of personal injury and boat damage.

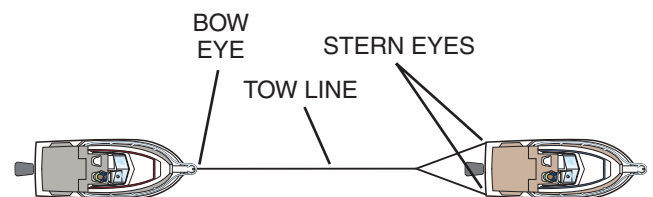

KC-0187C-A

Figure 4-4

WARNING! Use extreme caution when using tow lines and when connecting tow lines to cleats. Death or serious injury could occur if lines and/or cleats fail while they are under extreme tension.

Follow these guidelines when towing or being towed:

- Use extreme caution when throwing weighted lines to a boat in distress. When in rough seas, use a light throwing line with a weight secured on the throwing end and a heavier towing line secured to the other end.
- Never attempt to tow a boat larger or heavier than your own.
- Never attempt to tow a grounded, damaged or capsized boat.
- Use a tow line that is rated at least four times the gross weight of the boat being towed.
- Make sure tow lines are in good condition and are free of damage, cuts or abrasions.
- Attach a tow line to the bow eye on the disabled boat. Never attach a tow line to any point on the disabled boat other than the bow eye.
- Attach the tow line to the stern eyes of the tow boat. Wrap the tow line with chafing gear where it rubs against the boat or any corners.
- Leave at least two boat lengths between the boats for adequate movement.



Section 4

- Never allow anyone to be in line with the tow line. If the line breaks or pulls free, dangerous recoil could occur, resulting in severe injury or death to anyone in its path.
- Adjust the tow line to match wave action. Keep the boats on the crest or in the trough of the waves at the same time. In protected, calm waters, shorten the line for better handling.
- Tow at moderate speed, allowing for adverse wind and wave conditions.
- Have the operator of the towed boat steer with you if possible.
- Have a person on the tow boat watch the disabled vehicle and, if necessary, be available to signal the operator of the disabled boat.

Check with local and state authorities prior to towing for additional regulations and restrictions on towing other boats or equipment.



Section 5

OPERATING IN HAZARDOUS CONDITIONS

Before operating your boat, see *Safety on page 2-1*.

SEVERE WEATHER

Getting caught in severe weather can be dangerous and even fatal. Check with local weather stations, the USCG or weather-service broadcasts (162.55 or 162.40 MHz) for the latest conditions. Check the weather not only before you go out on the water, but also periodically while you are on the water. Consult the following websites for weather information:

- www.weather.com
- www.nws.noaa.gov
- www.navcen.uscg.gov

Storm Conditions

Take the following precautions if you operate your boat in storm conditions:

- Have all occupants wear life jackets.
- Turn on navigation lights.
- Locate and have inclement weather gear and safety equipment ready.
- Mark or identify your position.
- Close all ports, stow all gear and secure any loose equipment on deck.
- Reduce speed and head for port or a safe, easily reachable place.
- Keep a lookout for debris and obstructions in the water.
- When possible, head into the waves at a 45-degree angle. Allowing high waves to strike the side of your boat may cause it to capsize or swamp.
- If you lose power, keep your boat headed into the waves by rigging a sea anchor off the bow.

Fog Conditions

Avoid operating your boat in foggy weather, if possible. If you encounter fog conditions, return to port immediately. Also, take the following precautions:

- Reduce speed to a safe speed or idle.
- Take bearings and log your course and speed before the fog sets in. Use of a GPS is recommended.
- Have all occupants wear life jackets.
- Assign lookouts to the bow and stern to keep watch and listen.
- While navigating in fog, you must sound a five-second blast from your horn or whistle once every two minutes to alert other boaters of your position.
- If you determine that it is unsafe to continue navigating your boat, quickly find the best position to anchor. You must sound a five-second blast from your horn or whistle once every minute while anchored to alert other boaters of your position.

Reduced Visibility

Natural environments and inclement weather can cause reduced visibility. Storm condition hazards can be compounded by reduced visibility while on the water. Always use common sense and take safety precautions if you are operating your boat in reduced visibility conditions.



Section 5

Cold Weather and Cold or Frozen Water Conditions

Avoid operating your boat in cold water or weather conditions, and never operate in frozen or icy waters. Operating in these conditions significantly increases the risk of serious injury or death. Boating in these conditions can lead to cold-water immersion, shock or hypothermia. Weather conditions may hinder emergency rescue or assistance, and cold weather poses potential problems for on-board equipment, as well as the engine. See the *Engine Operator's Manual* and the equipment manufacturer's instructions for operating in cold weather.

WATER HAZARDS

Every waterway poses hazards that you must be aware of and avoid. These hazards include shallow water, tree stumps and sand bars. Ask local authorities and other boaters for information and consult a marine chart when boating on unfamiliar waters. As a boat operator, try to avoid all hazards, known and unknown.

Aquatic Vegetation/Weeds

Operating in weeded areas can be extremely hazardous. Aquatic vegetation can be a threat to your boat's drive system. Vegetation and weeds can wrap around the propeller, causing loss of propulsion and steering control. They may also restrict the engine water cooling intake, causing the engine to overheat. Avoid operating in or near vegetation. If you encounter any restriction because of vegetation, stop the engine. See the *Engine Operator's Manual* for recommendations on the removal of vegetation from the propeller and water cooling intake ports. Be extremely careful and never get into the water when clearing the propeller. Stay out of the water in highly congested vegetative areas, which can severely restrict your mobility and create a life-threatening situation. **NOTICE:** *Vegetation can sometimes be removed by shifting to NEUTRAL, pausing a moment, then shifting to REVERSE to unwind the vegetation from the propeller.*

Dams and Spillways

The waterways around dams and spillways are extremely hazardous. Dams and spillways are subject to rapid water flow changes, and may have floating and sunken debris in the nearby water. These areas are often marked as restricted, and it is best to always stay clear of them.

Shallow Water Operation

Operating in shallow water presents a number of hazards. Sandbars in narrow inlets are constantly shifting, making it difficult to mark them with buoys. Sandbars are sometimes indicated by waves as they form into breakers when passing over the sandbar. In coastal areas, tides can affect water level as much as 30 feet (9 meters). Check with local marinas or Coast Guard stations for tide tables and current charts.

RESTRICTED AREAS

Some waterways and areas are restricted. Always check with local, state and federal authorities to identify restricted areas. Because of the threat of terrorism, the USCG has implemented and will continue to enforce strict limits on watercraft near U.S. Navy and Coast Guard ships and other potential targets. For more information, contact the USCG or local authorities.

MARKERS, WARNINGS AND ADVISORIES

Find out from local authorities if hazards exist in areas where you intend to navigate, and know how these hazards are marked. You must also recognize flag designs that indicate hazards or activities that are present and keep well clear of those areas. Always watch for swimmers and stay clear of all swimming areas, marked or unmarked.



Operating in Hazardous Conditions



KC-0015C-A

Figure 5-1

Become familiar with navigation markers, which identify navigable routes and indicate water hazards. Always stay within marked boundaries and steer clear of hazards.

Distress flags and indicators are markers of potential emergencies and hazards. Become familiar with these flags and indicators. Additionally, understand your responsibilities when operating at these times and in these areas.

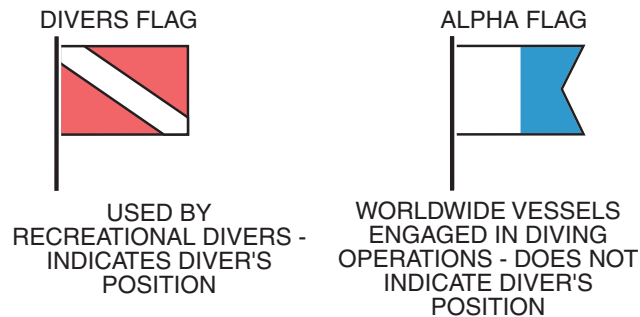

DISTRESS FLAG









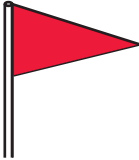

INDICATES FELLOW BOATER IS IN NEED OF ASSISTANCE

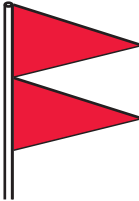
KC-0017C-B

Figure 5-2

Storm warning advisory flags and indicators alert boaters to impending weather conditions. Become familiar with these flags and indicators and understand the potential hazards associated with operating in these conditions.

DAYTIME WARNING	DESCRIPTION	NIGHTTIME WARNING
	Small Craft Advisory - Winds greater than 18 knots, sustained for two hours or more, or hazardous wave conditions. Following a storm, hazardous wave conditions can persist long after the high winds have subsided.	
	Gale Warning - Sustained winds (2 or more hours), of 34-47 knots.	
	Storm Warning - Sustained winds of 48 knots or greater.	
	Hurricane Warning - Forecast winds of 64 knots and above. Displayed only in connection with a hurricane.	

KC-0018C-A

Figure 5-3



Section 5

This Page Intentionally Left Blank



Section 6

NAVIGATION RULES AND AIDS

Before operating your boat, see *Safety on page 2-1*.

The following information outlines basic navigational rules. Boating regulations are enforced by USCG, state and local authorities. You are subject to marine navigation regulations for both federal and state waterways. For more information, contact the USCG, state and local marine authorities. The navigational rules for U.S. waterways can be found in the “Navigational Rules” publication. This publication can be found at most marine supply stores, or you may contact the USCG or visit:

www.navcen.uscg.gov/mwv/NavRules to view or download the publication.

Any boat 39 feet (12 meters) or longer must have a copy of the “Navigational Rules” publication on-board at all times. Failure to have this document on-board can result in penalties and/or fines.

RIGHT-OF-WAY

Boats with less maneuverability have right-of-way over more agile boats. You must stay clear of a boat with right-of-way. Examples of boats with right-of-way are:

- Boats aground or not under command
- Boats with restricted maneuverability
- Boats engaged in fishing
- Non-motor boats (having no power propulsion), i.e., rowboats, paddle boats, canoes and sailboats

Small pleasure craft must yield right-of-way to large commercial boats in narrow channels. A boat with right-of-way is sometimes referred to as the privileged boat.

The General Prudential Rule

The general prudential rule regarding right-of-way is if a collision appears unavoidable, neither boat has right-of-way. Both boats must act to avoid collision.

AUDIBLE DISTRESS SIGNALS

It is not necessary to sound a signal every time a boat is nearby. It is typical for boat operators to signal their intention, using a whistle, horn or bell, to avoid potentially confusing or hazardous situations. Privileged boat operators customarily signal first, then the yielding boat operators return the same signal to acknowledge they understand and will comply. Use the danger signal (five or more short, rapid blasts) if intent is not clear.

Use the following signal blasts early enough so other boaters notice and understand them:

Audible Distress Signal	Definition
One long blast	Warning signal (coming out of slip or passing astern)
One short blast	Pass on port side
Two short blasts	Pass on starboard side
Three short blasts	Engine(s) in reverse
Five or more short blasts	Danger signal

NAVIGATIONAL LIGHTS AND NIGHT OPERATION

Navigational lights alert other boats to your presence and course, especially when operating at night or in restricted visibility conditions.

Regulations require that navigational lights be clearly lit and properly displayed at all times between sunset and sunrise, and always when operating in reduced visibility. Where applicable, lights must appear on the sides, stern, masthead and all-around positions.

All navigational rules apply at night, but speed is restricted on many waterways. Night boaters must operate at a slow, safe speed and stay clear of all boats, regardless of which boat has right-of-way.



Section 6

Protect your night vision by avoiding bright lights. If possible, have a passenger help keep watch for other boats, water hazards and aids to navigation.

The size, speed and direction of other vessels are determined at night by white, green and red running lights.

- A green light indicates the starboard side of the boat. Generally, if you see a green light on another boat, you have the right-of-way. Hold your course.
- A red light indicates the port side of the boat. Generally, if you see a red light on another boat, they have right-of-way and you must yield your course.

SPEED

As the operator, you are responsible for maintaining your boat under control at a safe speed. Many state and local boating authorities enforce speed limits. Regulations may vary from state to state. Contact your local and state boating authorities for specific information.

WAKE

You, as the operator, are responsible for the wake your boat creates. Always be alert for NO WAKE zones and be courteous of others while boating. Excessive and unexpected wakes can cause dangerous and even life-threatening situations. Regulations may vary from state to state. Contact your local and state boating authorities for specific information, as you may be responsible for any damage or injury your wake causes.

OVERTAKING / PASSING

The boat overtaking or passing must yield right-of-way to the boat being passed. The overtaking boat must make any adjustments necessary to keep out of the way of the boat being passed. The boat being passed has the right-of-way and must hold its course and speed.

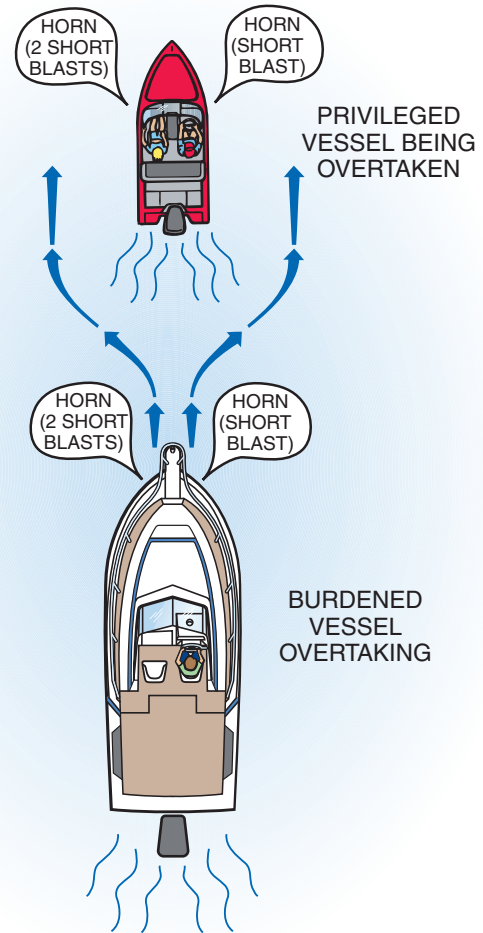

KC-0091C-A

Figure 6-1



Navigation Rules and Aids

MEETING HEAD-ON

When two boats meet head-on, neither boat has the right-of-way. Both boats should decrease speed, turn to the right and pass port to port. If, however, both boats are on the left side of a channel, each vessel should sound two short horn blasts and pass starboard to starboard.

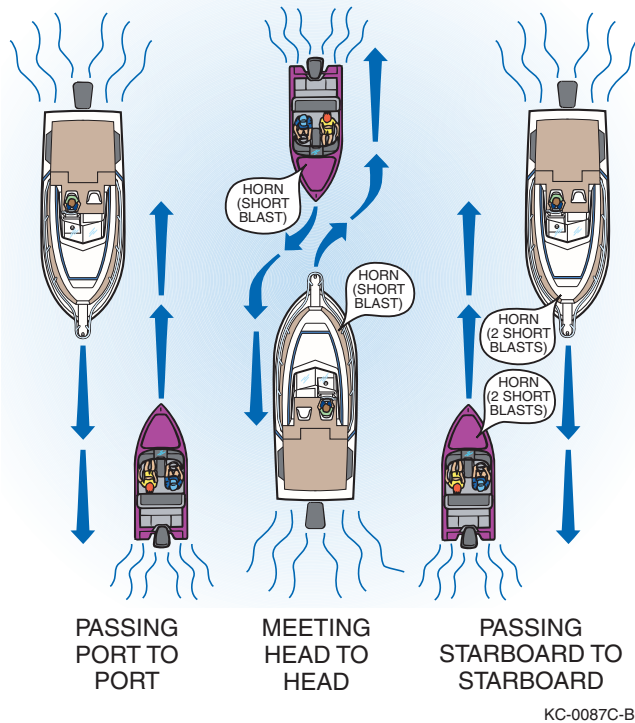

Figure 6-2

CROSSING

In crossing situations, the boat to the right from the 12 o'clock to the 4 o'clock position has the right-of-way and must hold course and speed. The boat without right-of-way must yield and pass to the stern of the privileged boat. Boats going up and down a river have the right-of-way over boats crossing the river.

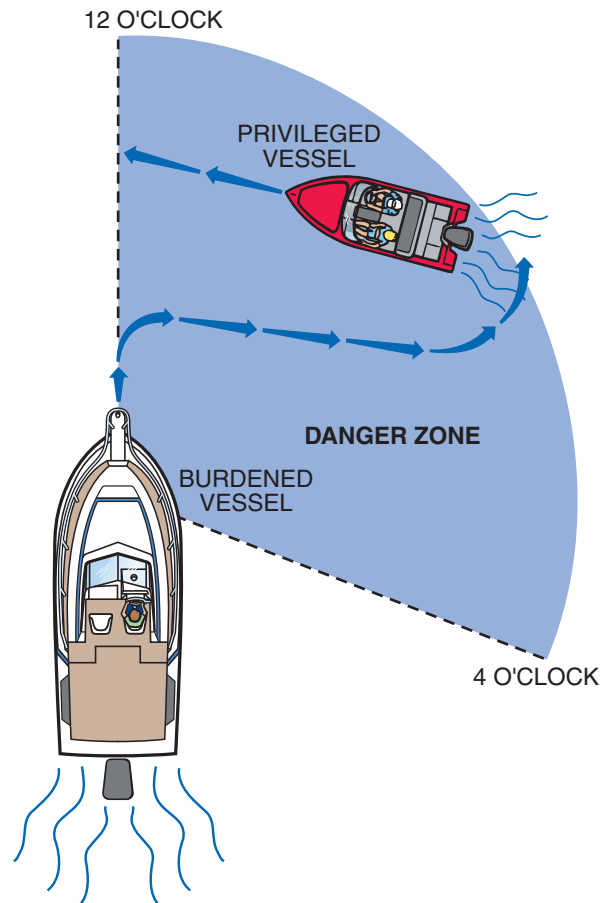

Figure 6-3



Section 6

AIDS TO NAVIGATION

Learn to recognize the different buoys and day markers; they are the signposts of the waterways. The United States Aids to Navigation System (USATONS) is the primary marking system used on inland water, coastal waters and rivers. This system is maintained by the USCG.

Navigational aids are designed and placed accordingly to help you navigate safely on the water. Learn to recognize the different buoys and day markers.

The following information is based on the USATONS. For further information, contact the USCG and state and local marine authorities. Also visit www.uscg.mil for buoyage system information.

The USATONS uses buoys, beacons and minor lights as markers.

NEVER tie or anchor to a navigational aid. This action is unlawful and dangerous to you, your boat and other boaters.

NEVER move or damage a navigational aid. This action is unlawful and dangerous for other boaters.

Buoys

Most anchored floating markers are generally referred to as buoys. Buoys have many uses and color schemes, and can vary in size and shape. The most commonly used buoy colors are white, red, green, yellow and black. Buoys may be unlighted or lighted. Some are audible; others have both an audible and a visual signal. Lights, bells and horns on buoys aid in night boating or poor visibility conditions. Buoys with unique light-flashing characteristics are identified on nautical charts with the specific flashing pattern.

Become familiar with the specific buoys used in the waters where you are boating. Contact local authorities for specific information and/or navigational aid charts for your waterways.

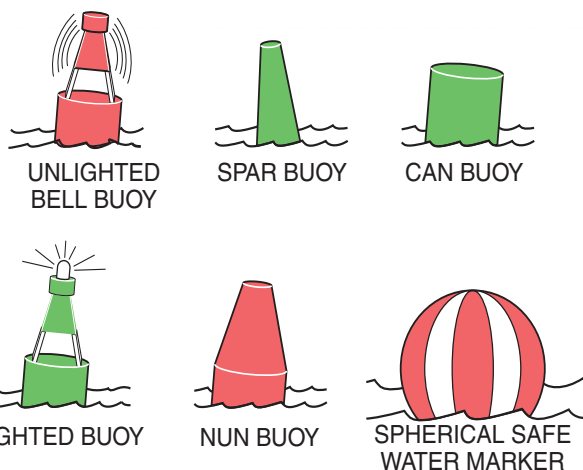

Figure 6-4

Mooring Buoys

The only buoys you are permitted to moor to are mooring buoys. Mooring buoys are white with a blue horizontal stripe. Mooring to a navigation buoy, regulatory markers or lateral markers is illegal.

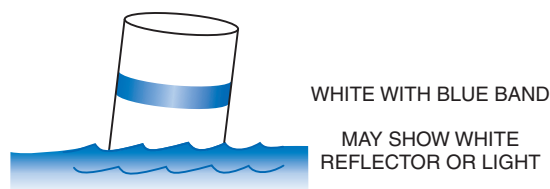

Figure 6-5

KC-0020C-A



Navigation Rules and Aids

Daymarks / Dayboards

Daymarks or dayboards are fixed visual markers in the water. The markers are commonly attached to a post or piling and are sometimes accompanied by a light. Daymarks are either red or green and are usually triangular- or square-shaped, though their shapes can vary. Daymarks often display numbers, which act as navigation guides. Red daymarks are usually triangular and sometimes show an odd number. Green daymarks are usually square and sometimes show an even number. The numbers on the markers are sequential and increase from seaward.

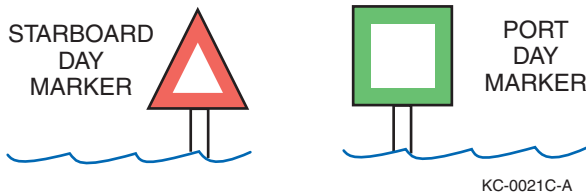

Figure 6-6

Lights and Lighted Structures

Maneuvering a boat at night can be dangerous and confusing. To aid boaters with navigation and to warn of hazards, the USCG and state and local authorities maintain a variety of light structures. Some light structures are equipped with radio beacons, radar reflectors and/or fog signals.

Minor Lights

Minor lights are colored according to the buoyage marking system in use. They are similar to lighted buoys, except they are usually higher and on more stable platforms to increase visibility. Most minor lights are part of a series to mark a channel, river, or harbor and fairways.

Range Lights

Range lights are usually visible in one direction and help a boat operator navigate safely. Steering a course to keep range lights arranged in a line (one on top of the other) will help guide a boat through a channel.

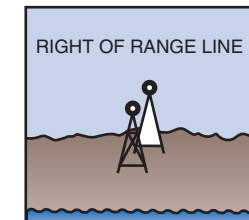
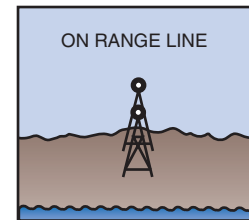
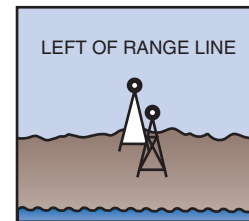
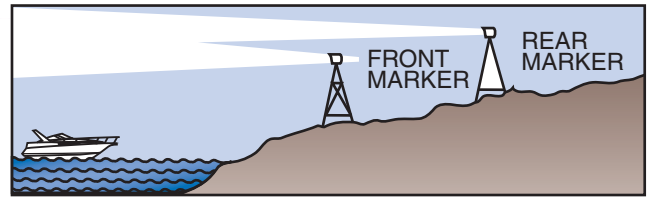

Figure 6-7

KC-0022C-B



Section 6

Lighthouses

Lighthouses can be found at harbor entrances, prominent headlands, isolated danger areas and along the coasts. These striped or patterned structures have unique flashing signals, which help boaters identify them.

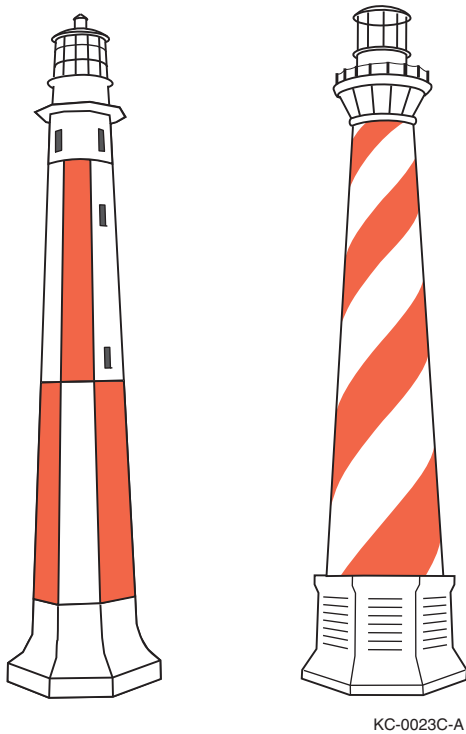

Figure 6-8

Markers

Seven (7) types of markers are used to assist the boat operator:

- Regulatory
- Range
- Special
- Lateral
- Safe Water
- Preferred Channel
- Isolated Danger

Regulatory Markers

Regulatory markers are used to display information or indicate danger. Regulatory markers can be fixed visual markers or anchored floating buoys.

Fixed visual markers are usually white with orange geometric shapes that display information. Anchored floating buoys are white cylinder-shaped buoys with orange bands at the top and orange geometric shapes that may display information.

Following are the various orange geometric shapes used on these markers:

- Diamond – Indicates danger
- Diamond with cross marks inside – Indicates that a boater must keep away
- Circle – Indicates a controlled area or speed limit
- Square – Displays important information

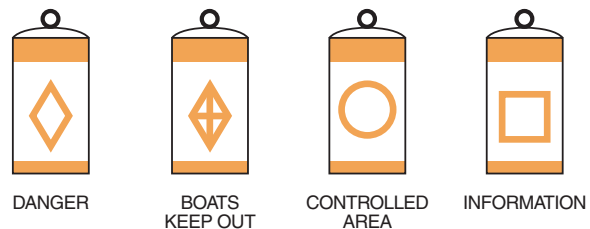

KC-0244C-A

Figure 6-9



Navigation Rules and Aids

Range Markers

Range markers have many color schemes, may have numbers or letters and may be lighted or unlighted. They are placed in pairs within close distance of each other. They are commonly used in channels to guide boats safely through the center or safe line of navigation. Keep range markers visually in line with each other while navigating the waterway to avoid obstacles or other invisible dangers.

Special Markers

Special markers are yellow and come in various styles and shapes. Lighted and unlighted daymarks and buoys vary in function. Many are used to display information and navigational direction rules. The most common special markers are those used in intercoastal waterways. Contact your state and local authorities for more information on special markers used in your boating area.

Lateral Markers

Lateral markers are used to mark the sides of navigable channels. They can be buoys, daymarks or minor lights, and are red and green in color. They can be lighted or unlighted and may or may not have numbers.

The basic nautical rule of lateral markers is the phrase “Red, Right, Returning.”

The term “sea” generally refers to the ocean or a large body of water. “Seaward” refers to traveling from the sea or a large body of water inland or to a smaller body of water.

When traveling seaward – keep red markers to your port (left) and green markers to your starboard (right).

When returning from seaward – keep red markers to your starboard (right) and green markers to your port (left).

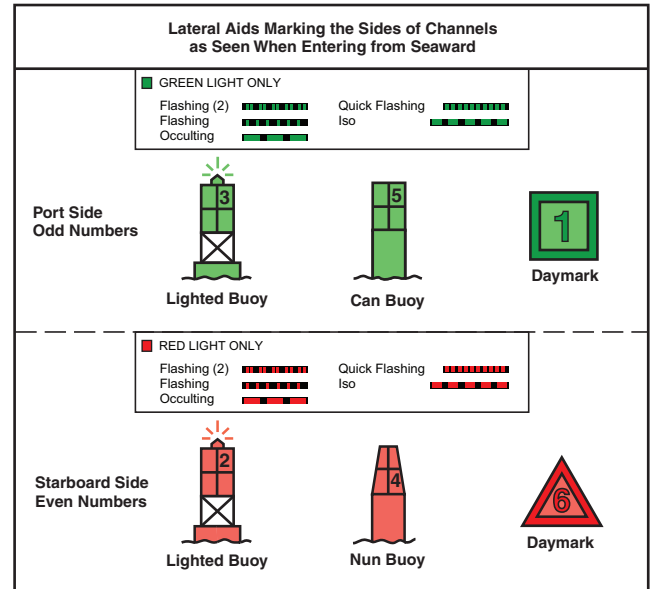

KC-0054C-B

Figure 6-10

Safe Water Markers

Fairways and mid-channels may be marked with safe water markers or buoys. These markers indicate safe water all around. Safe water markers are red and white with vertical stripes, and are round or have a red spherical top mark.

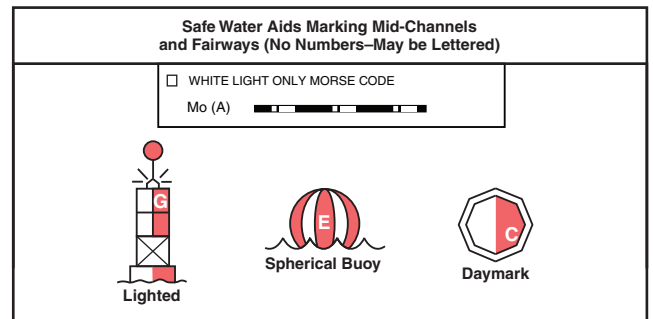

KC-0055C-B

Figure 6-11



Section 6

Preferred Channel Markers

Obstructions, channel junctions and preferred channels are marked with red and green horizontally striped can and nun-style buoys. The top band color indicates the preferred path to take. Use these markers in the same manner as lateral markers to follow preferred channels.

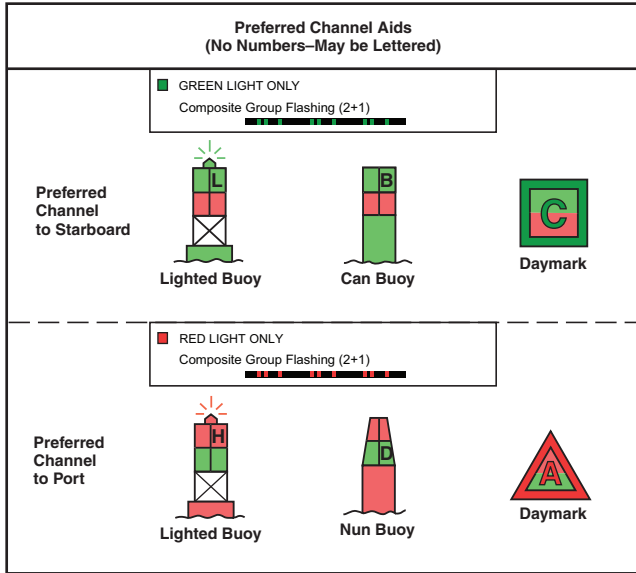
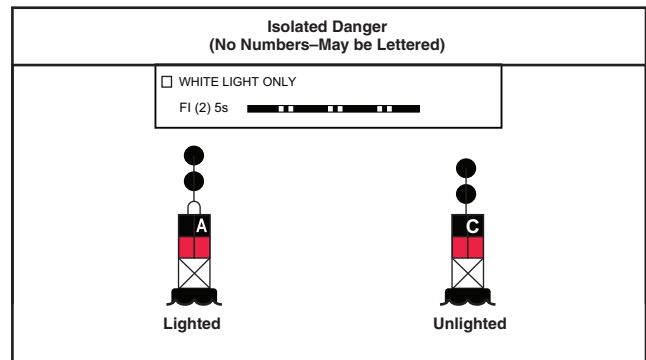

Figure 6-12

KC-0056C-B

Isolated Danger Markers

Isolated danger markers indicate an isolated danger which may be passed on all sides. These markers are black with one or more broad horizontal red bands and are equipped with a top mark of two black spheres, one above the other. On inland waters, a buoy with alternating vertical black and white stripes may be used to indicate that an obstruction or other danger exists between the buoy and the nearest shore. Do not pass between the buoy and the shore.



KC-0057C-B

Figure 6-13

Other Special Signs and Markers

Various signs and markers are used throughout U.S. waterways for different purposes. In Florida, special signs are used to warn of "manatee" areas. These signs help to control speed and/or restrict areas from boating to conserve this endangered species. As a boat owner and operator, be aware of special information and markers on the waterways. Contact your state and local authorities for more information on local restricted or controlled areas and their markers.



Section 7

OPERATING YOUR BOAT

Before operating your boat, see *Safety on page 2-1*.

SAFETY PRECAUTIONS

WARNING

These safety messages describe hazardous situations which, if not avoided, *could* result in death or serious injury.

Runaway Boat Hazard

Certain actions can cause you to lose control of your boat:

- When accelerating your boat in the forward direction, the bow can rise and restrict visibility. Observe for obstacles and people before accelerating.
- The rotational thrust of the propeller under rapid acceleration can create high steering torque and rapidly change the direction of steering, causing loss of control.
- Do not trim the engine out too far or the boat may begin to “porpoise” (bounce up and down). Porpoising reduces control and visibility.
- If you lose control of your boat, pull back on the throttle and trim in at the same time.
- Improper use of trim tabs or moving them down at high speeds can cause an accident or injury.

BEFORE GETTING UNDER WAY

Safety Equipment

Federal and local laws require certain safety equipment to be on-board at all times. Responsible boaters carry additional equipment in case of emergency.

Float Plan

Complete a float plan before departure and leave it with a reliable person who is aware of your intentions while on the water. In case of emergency or if you do not return as planned, this information can be helpful to the USCG or others in rescuing or contacting you. For more information on float plans or to download a float plan form, visit the U.S. Coast Guard Auxiliary website at:

<http://www.floatplan.uscgaux.info>.

Pre-Departure Safety Checklist

The following checks are essential to safe boating and must be performed before starting the engine or getting under way. Perform these checks every time you operate your boat so they become routine.

Never launch the boat or leave the safety of the dock if any problem is found during the pre-departure safety check. A problem could lead to an accident during the outing, causing severe injury or death. Have any problems corrected before proceeding:

- Check the current and forecasted weather reports, as well as wind and water conditions.
- Make sure the operator is qualified to operate the boat and does not use drugs or alcohol while at the helm.
- Make sure all required safety equipment is on-board.
- Make all passengers aware of safety procedures.
- File a float plan.
- Have all required documents on-board.
- Have all maps or navigational charts for the intended destination on-board.
- Be sure all passengers are properly seated.
- Be sure the boat is not overloaded.
- Check the engine emergency stop switch lanyard for proper installation and operation.



Section 7

- Be sure the fire extinguisher is fully charged.
- Check bilge drain plugs for proper installation.
- Be sure all water has been pumped from the bilge area.
- Have plenty of emergency food and water on-board.
- Check the bilge blower (if equipped) for proper operation, and be sure no fumes are present in the bilge area.
- Be sure all required equipment is on-board (mooring lines, anchor lines, tool kit, etc.).
- Be sure you have enough fuel for the return trip.
- Check all compartments for fuel fumes.
- Check that no fuel, oil or water is leaking or has leaked into the bilge compartment.
- Check all hoses and connections for leakage and damage.
- Check the hull and propeller for damage.
- Check the engine cooling water intake pickup for blockage.
- Check that batteries are fully charged and the battery terminals are clean and tight.
- Check the electrical systems and navigation lights for proper operation.
- Be sure no person or obstacle is near the propeller.
- Check that the throttle/shift control is in the NEUTRAL position.
- Check the steering system for proper operation.
- Check that all required maintenance has been performed.

Boarding

Helpful guidelines when boarding a boat:

- Always step, rather than jump, into a boat.
- Avoid stepping on fiberglass or other potentially slippery surfaces.
- Always board one person at a time.
- Never board while carrying gear. Set the gear on the dock, board the boat and then pick up the gear.
- Never use the engine unit as a boarding ramp.
- It is courteous to always ask for permission to board so the owner/operator is aware of your presence on the boat.

Boat Loading

The safety and performance of your boat depends on load, weight and the distribution of each.

The person/load capacity is determined by the USCG. A capacity plate is usually located within clear visibility of the boat operator or helm area. The capacity plate indicates limits for loading the boat, which are enforceable by law.

WARNING! NEVER exceed the USCG certified maximum capacities under any circumstances. Exceeding the limitations stated on the capacity plate can cause the boat to sink or the passengers and/or operator to drown, resulting in death or serious injury.

- Board passengers one at a time and distribute them equally to maintain equal buoyancy of the boat.
- Distribute weight equally from port to starboard and fore to aft. The shifting of weight may be required when under way to maintain an efficient trim position for optimum performance.
- Stow and secure all loose gear in stowage areas to prevent load shifting.
- Do not stow gear on top of safety equipment; safety equipment must be quickly accessible.
- In adverse weather, reduce the load in the boat. Person and load capacity ratings are calculated for normal boating conditions.

Be sure all passengers are properly seated and not riding on the bow, bow pulpit, deck, gunwale or rear sun deck while under way. Use caution when riding in the bow. Move to the aft passenger seats during rough water operation.

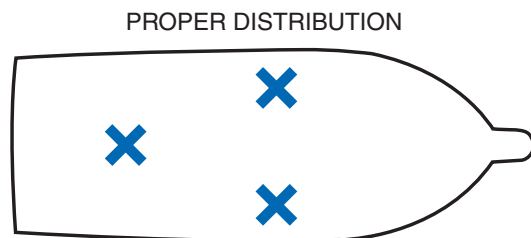

KC-0132-A

Figure 7-1



IMPROPER DISTRIBUTION (BOW HEAVY)

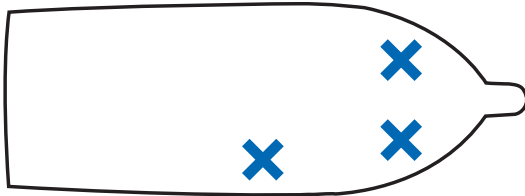

KC-0134-A

Figure 7-2

IMPROPER DISTRIBUTION
(STARBOARD HEAVY)

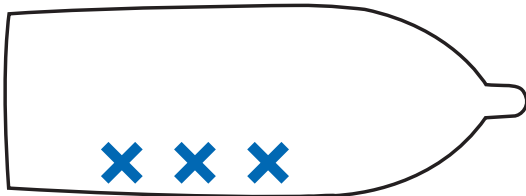

KC-0136-A

Figure 7-3

Fuel Management

Use the “one-third” rule for fuel management. Use one-third of the fuel to reach your destination, one-third to return and one-third as reserve fuel.

Outboard engines with oil injection may also have separate tanks and fillers for the oil reservoir. Use lubricant recommended by the engine manufacturer. See the *Engine Operator's Manual* for information.

Fueling

The fuel filler on boats with built-in tanks is usually located in the aft area. The fuel tank is equipped with either a shutoff valve or antisiphon valve. The shutoff valve requires you to manually turn the fuel valve, while the antisiphon valve operates automatically. Because gasoline fumes are heavier than air, they will sink to the lowest part of your boat, such as the bilge. Always evacuate fumes with the bilge blower (if equipped) before attempting to start the engine.

NOTICE: To prevent unwarranted engine damage, see your *Engine Operator's Manual* for manufacturer-recommended fuel and oil specifications.

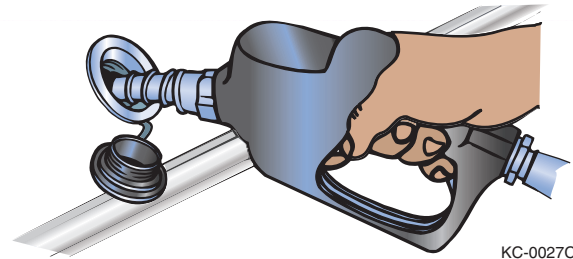

KC-0027C-A

Figure 7-4

When refueling, observe the following:

- Have a proper and charged fire extinguisher ready. **WARNING! Gasoline is extremely flammable and highly explosive under certain conditions. See the Safety Section for more details.**
- Secure the boat to the dock.
- Stop all engines, motors and fans before refueling.
- Never smoke or allow open flames or sparks within 50 feet (15 meters) of the fueling area.
- Close all doors, windows, hatches and ports that could allow fuel vapors to enter the boat's enclosed spaces.
- Avoid spills and know how much fuel is already in the tank before adding fuel. Wipe up any spills immediately.
- Always fill fuel tanks slowly. Be aware that if the boat's attitude changes while floating, the fuel level and position change in the tank, which could cause spillage.
- Never overfill the fuel tanks.
- Always allow space (at least 6%) for expansion of fuel in the fuel tank.
- Always be sure you are filling the proper tank; some deck filler plates appear similar to the fuel tank.
- Never pump fuel into an unapproved container.
- Use only fuel approved by the engine manufacturer.
- Check for fuel leaks.
- Refuel only at safe and approved filling stations such as marina fuel docks or automotive fuel stations. Approved venues have safeguards in place to lessen the likelihood of static discharge.
- Read and follow all warnings on the pump or in the vicinity of the pump.



Section 7

- Maintain contact between the fuel nozzle and the fill pipe at all times, before and during refueling, to prevent an electrostatic spark.
- Keep away from the fuel tank vent to avoid splash-back and fumes.
- Never reenter your vehicle while refueling on land and towing your boat. Getting into and out of your vehicle might build up a static charge that could ignite the fumes at the fill pipe.
- If a fire occurs, do not panic, and do not remove the nozzle from the gas tank.
- Evacuate all passengers from the vehicle and refueling area, and immediately alert station attendants so they can use the emergency shutoff and fire extinguisher.
- If you are unable to pump fuel at a reasonable speed, check the fuel tank vent for restrictions.

After refueling, observe the following:

The first time you fill your boat's fuel tank(s) and after each refueling, check the entire fuel system for leaks and/or damaged parts. Leaks and/or damaged parts must be repaired and the area ventilated to remove explosive fumes.

- Close the fill cap(s) securely.
- Wipe up any spilled fuel completely. Dispose of the rags properly.
- Open all doors, windows, hatches and ports to ventilate all spaces.
- Check for fuel vapors before starting any engines or appliances.
- Operate the bilge blower (if equipped) before the engine is started for a minimum of four minutes.

GETTING UNDER WAY

The following basic boat maneuvering and operation principles do not cover all conditions or situations you may encounter during operation. It is important for you and anyone else operating the boat to have certified instruction from local boating authorities.

Always advise all passengers on-board of your steering, stopping and accelerating intentions to avoid personal injury or even death.

Make sure all passengers are properly seated and not riding on the bow, bow pulpit, deck, gunwale or rear sun deck while under way. Use caution when riding in the bow. Move to the aft passenger seats during rough water operation.

Starting

The following information is intended as a basic guideline only and may not apply to your specific engine or controls. See the *Engine Operator's Manual* or control manufacturer's information for instructions on starting and operating the engine, adjustments and maintenance.

- Secure your boat to the dock before starting the engine.
- Check that the throttle is in the NEUTRAL position.
- Turn the battery selector switch to the appropriate ON position.
- Operate the bilge blower (if equipped) long enough to fully evacuate the engine and bilge compartments of explosive fumes.
- Attach the engine emergency stop switch lanyard to the boat operator.
- Check that all passengers are seated properly.
- Position the lower drive power trim to the full DOWN position.
- Start the engine.



Operating Your Boat

Steering

Steering a boat is very different from steering an automobile. Steering and maneuvering a boat is far more difficult and requires time and practice to master.

When steering a boat, it is important to understand the causes and effects of turning. Since both thrust and steering are at the stern of the boat, the stern will push away from the direction the steering wheel (helm) or tiller arm is turned. The boat seems to skid across the water while turning, which feels very different from an automobile making a turn.

Steering in reverse has its own challenges. Practice forward and reverse steering to gain comfort and to feel in control of your boat in any steering situation.

Be prepared for wind and current while steering your boat. Steering in wind or water currents is difficult and requires skill to be able to anticipate and compensate for these effects.

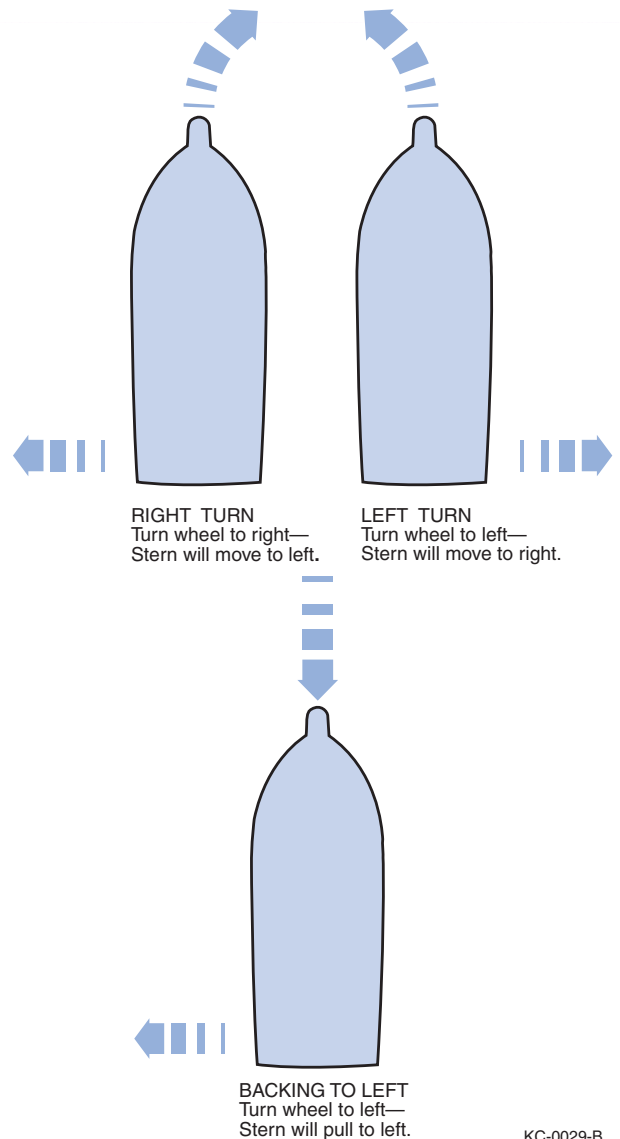

Figure 7-5

KC-0029-B



Section 7

Rotational thrust of the propeller is an aspect most propeller-driven boats share and needs to be compensated for at slow speeds. During rotational thrust, torque is transmitted to the helm and may cause your boat to drift either port or starboard when moving forward at a slow speed. Rotational thrust usually goes unnoticed at high speeds. While moving forward at a slow speed, constant helm corrections are usually necessary to maintain a straight course.

Twin-engine boats usually compensate for rotational thrust of the propellers by using one counterrotating drive with a counterrotating propeller, and one standard clockwise-rotating drive and propeller to reduce the effects of steering torque at all boat speeds.

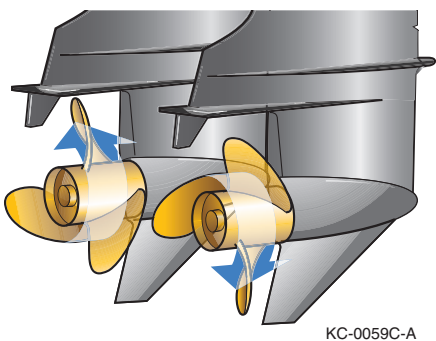

Figure 7-6

Twin-Engine Steering

When maneuvering with twin engines at low speeds, steer using the independent thrust of the port and starboard drives in conjunction with helm movements. Steering in this manner can be very effective, especially when maneuvering in restricted areas and when docking.

Practice using the throttles to control steering of your boat. Practice these maneuvers in open water away from others before attempting them near docks or other boats.

- Before attempting to make close turns at low speed, always position the throttles in IDLE.

- Reverse the direction of the engine on the side you want to turn. If you want to turn starboard, for example, shift the starboard engine into REVERSE. The forward speed of the port engine, along with the reverse rotation of the starboard engine, will pivot your boat into a starboard turn.
- Use quick “bursts” of throttle to control your boat. Keep in mind that once your boat starts to move, momentum will carry it through.

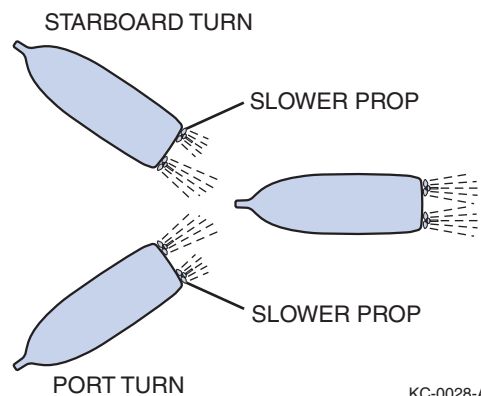

Figure 7-7

Stopping

A boat does not have brakes. Controlling your boat to a stop and while stopped are important skills that must be learned. Reverse thrust is commonly used to slow and stop a boat. The continued momentum of a boat will vary according to the boat design, load and speed. You must also consider and learn to compensate for the effects of wind and current. Stopping in wind or water currents is difficult and requires skill to be able to anticipate and compensate for these effects.

- To stop or slow forward motion, always gradually return the throttle(s) to the slow IDLE position, pause and shift into NEUTRAL, then pause and shift into REVERSE. **WARNING! Always gradually return the throttle(s) to the slow IDLE position. Failure to do so can cause loss of boat control, personal injury or death, and engine propulsion system damage.**



Operating Your Boat

- If your boat has been driven for a long period of time at high speed, allow the engine a two- to three-minute cool-down period at low idle in NEUTRAL.
- Turn the ignition key to the OFF position.
NOTICE: Never pull the lanyard from the engine emergency stop switch for normal shutdown. Doing so may impair your ability to restart the engine quickly.
- Avoid collisions; at high speeds your boat will require more time and distance to stop or slow.
- The proper use of trim tabs and outdrive trim angle is important when slowing to a stop. Qualified local boating authorities can provide proper instruction in slowing and stopping your boat.

Shifting

The following information is a basic guideline only and may not apply to your specific shift control. See the *Engine Operator's Manual* or control manufacturer's information for the shift control operation, adjustment and maintenance.

- Most throttle and shift controls have a neutral detent locking lever that must be released before shifting from NEUTRAL.
- Always use a brisk and decisive movement when shifting into or out of gear.
- Always pause in NEUTRAL before shifting from FORWARD to REVERSE, or REVERSE to FORWARD. Most throttle and shift controls have a detent position for NEUTRAL, FORWARD and REVERSE engagement positions. These detent positions are important; when shifting into and out of gear, always pause in these positions.
- Never shift into REVERSE while your boat is in FORWARD gear when traveling at a high speed.
- Always keep the shift control clean and clear of obstructions.

Accelerating and Running Under Way

You must understand your boat's equipment and controls in order to drive and control your boat in a forward direction at all speeds and in all conditions. Learning to drive and control your boat can be challenging; take this matter seriously and spend plenty of time practicing.

WARNING! When accelerating the boat in the forward direction, the bow can rise and restrict visibility.

The phrase "on plane" is commonly used when referring to the running angle of a boat in forward motion. When a boat is "on plane," its hull is usually running level or almost level with the water's surface, which is considered level. The level "plane" of the water's surface is the most efficient angle to run in. This basically means that the boat is running on top of the water and not plowing through it.

Factors to consider when accelerating a boat forward and running at the most efficient planing angle are:

- Boat design
- Hull type and condition
- Boat load and distribution of weight
- Engine capability and condition
- Propeller type, size and condition
- Outdrive and boat power trim equipment and condition

Because all boats are different and vary in design, purpose and load, planing angles and characteristics will vary among all boats. Become familiar with your boat's characteristics and obtain qualified assistance.

The following guidelines provide a basic understanding of forward acceleration and operating on plane while under way:

- Always look in front of and around you before proceeding. Avoid collisions before accelerating; be aware and stay clear of people and obstacles in the water.
- Always advise all passengers on-board of your intention to accelerate and get under way.
- Stow and fasten all loose gear.



Section 7

- Make sure the engine emergency stop switch lanyard is connected to your person.
- If equipped, adjust your boat trim tabs up or to a neutral position with the hull.
- If equipped, adjust the engine power trim to the full-in position.
- Shift from NEUTRAL into FORWARD detent idle position.
- Adjust steering to the direction of travel.
- Using a controlled and constant motion, move the throttle control forward. **WARNING! When accelerating forward, the bow can rise and restrict visibility. Never remove your hand from the helm. The rotational thrust of the propeller under rapid acceleration can create high steering torque and rapidly change the direction of steering, causing loss of control, personal injury or death.**
- As your boat begins to move, the bow will rise and the boat will tend to plow through the water. As acceleration increases, your boat will begin to plane or level out within a few seconds. If it will not plane to a near-level position, slowly reduce the throttle back to the FORWARD detent idle position. Recheck your load and trim equipment position to determine the cause.
- Once the boat is on plane, the steering torque will diminish; however, never remove your hands from the helm while under way. While running at a planed position, you will notice greater throttle response and steering control as you continue to accelerate or achieve the most comfortable and safe speed for the conditions. You can achieve better performance, control and running efficiency using the engine's power trim and the boat's trim tabs, if equipped.
- Be aware of the wake you create and anticipate the effect it will have on others. During acceleration, deceleration and at speeds other than on plane, a heavy wake is usually created. You are responsible for your boat's wake and any damage or injury it causes.
- Obey no-wake areas and speed-controlled areas.
- Stay clear of or at a safe distance from other boats.
- Avoid collisions; at high speeds your boat will require more time and distance to stop or slow.

Checks During and After Operation

- Check gauges frequently for signs of abnormal conditions.
- Check that controls operate smoothly.
- Check for excessive vibration.

Trim Tabs

Trim tabs adjust the boat's trim angle and are primarily used to compensate for uneven weight distribution, listing, water conditions and other factors that can hinder efficient planing. Trim tabs are either power or manually adjusted, and vary in application, style and shape.

Trim tabs are added to a boat's hull at the stern to lift the stern and effectively make the hull longer. Trim tabs raise and lower to deflect and redirect water. This change in water flow creates upward pressure under the tabs, raising the stern and at the same time lowering the bow. The tabs are commonly used at the same time. They can, however, be used independently to adjust for water conditions, wind and boat weight distribution.

Trim tabs can sometimes help to keep a boat on plane at lower speeds and help a boat achieve plane quicker. The boat operator can adjust trim tabs by using a switch at the helm area. Trim tab gauges are available in most applications to provide a visual gauge-to-trim position. Most gauges indicate trim position in a range from UP (out) to DOWN (in).

Trim tabs are primarily used in conjunction with the engine's power trim.

General trim tab operation guidelines:

- When getting on plane, adjust the trim tabs to the best position to allow the boat to plane. A few trial runs will help you determine what position works best for your application. In most applications, this will be full up or parallel with the hull at a neutral angle. The further down the trim tab position, the more the stern lift increases and the bow lift decreases.
- Once on or near plane, use the engine's power trim to achieve better control and an efficient planing position.



Operating Your Boat

- Further adjust (usually UP) the trim tabs to fine-tune planing efficiency and increase speed.

WARNING! Improper use of trim tabs or moving them DOWN at high speeds can cause an accident or injury. See Safety Precautions at the beginning of this section for more details.

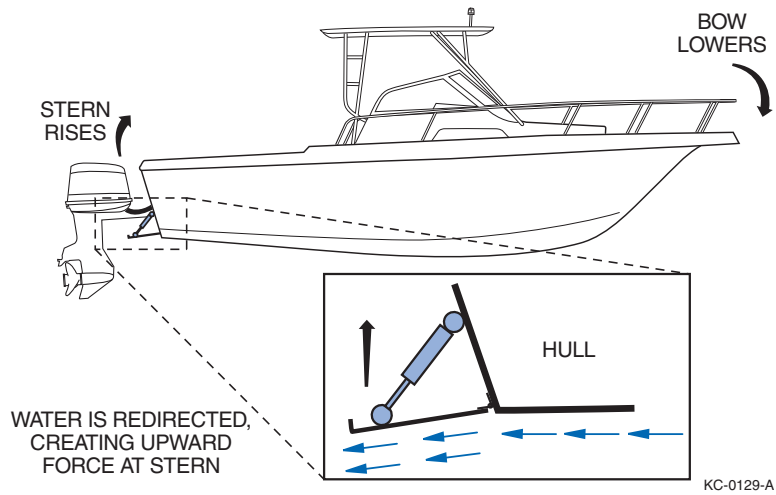

Figure 7-8

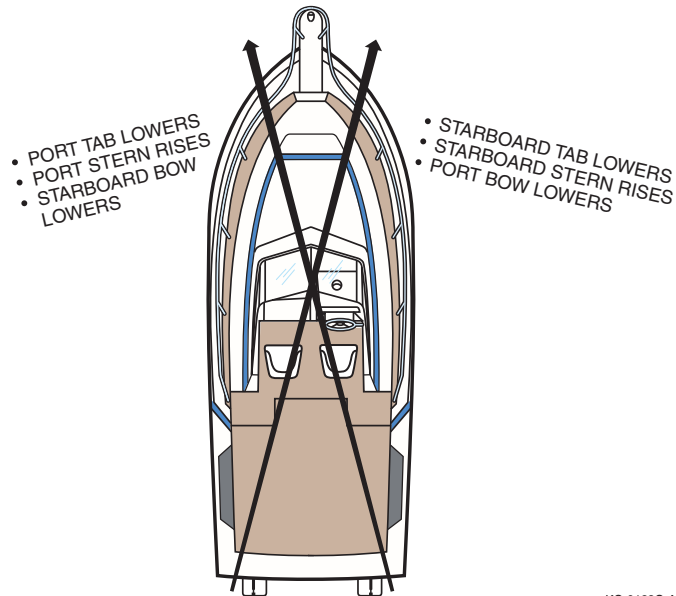

Figure 7-9



Section 7

Power Trim and Tilt

The following information is a basic guideline only and may not apply to your specific power tilt unit. See the *Engine Operator's Manual* for information on your power tilt operation, adjustment and maintenance.

The engine's power tilt generally operates in conjunction with the power trim system, which is commonly called power trim and tilt. This system allows you to raise and lower the lower drive unit and propeller to adjust trim (the planing and running angle of the boat while under way) and tilt (used to position the lower drive unit up beyond the power trim range used for trailering, launching or beaching). Never use power tilt while the engine is running.

Power Trim Operation

The following information is a basic guideline only and may not apply to your specific power trim unit. See the *Engine Operator's Manual* for information on your power trim operation, adjustment and maintenance.

The engine's power trim allows you to raise and lower the lower drive unit and propeller to adjust the planing and running angle of the boat while under way.

Boat trim adjustment while under way greatly affects boat performance and efficiency. During normal operation while under way at speed, trim your boat to the best possible position to reduce the wetted surface of the hull. With less boat in the water, both speed and fuel economy increase. Adjust systems with manual trim adjustment for best overall operation for the load and conditions. Engines with power trim allow for continuous adjustment for best results.

You can adjust the power trim by using a switch at the helm area or on the throttle control. Trim gauges are available in most applications to provide a visual gauge-to-trim position. Most gauges indicate trim position between UP (out, away from the transom) and DOWN (in, closer to the transom).

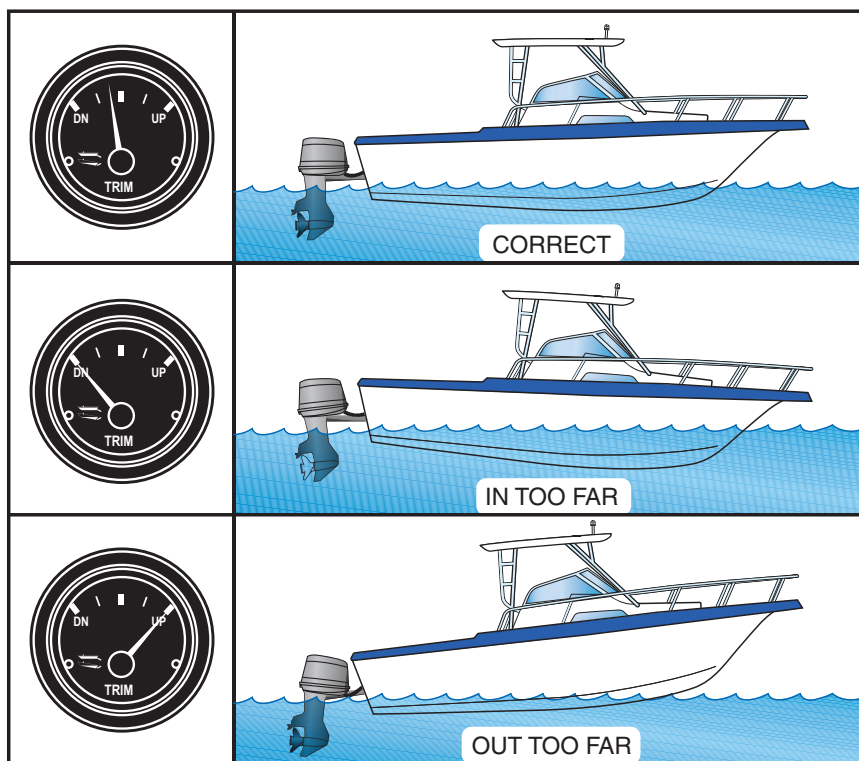

KC-0127C-A

Figure 7-10



Operating Your Boat

General effects of power trim under way:

Trim in too far (closer to the transom):

- Speed decreases.
- Fuel economy decreases.
- Boat may handle and steer poorly.
- Boat will have difficulty achieving a proper running, planing position.

Trim out too far (away from the transom):

- Steering torque increases.
- Speed decreases.
- Fuel economy decreases.
- Boat may handle and steer poorly.
- Boat will bounce or porpoise.
- Engine RPM increases.
- Propeller may ventilate as it nears the surface of the water and slip excessively as it pulls air from the surface. This will cause engine RPM to rapidly rise.
- Boat will have difficulty getting on plane from an idle position.

WARNING! Do not trim the engine out too far or you may lose control of your boat. See Safety Precautions at the beginning of this section for more details.

General power trim operation guidelines:

- When getting on plane from an idle position, start with the trim full in. As the throttle position increases, the boat speed will increase and drive the bow up. As acceleration proceeds, the bow will start to come down. When the bow starts to fall and the boat begins to plane, slowly start to trim out.
- Trimming out while under way generally causes the boat to rise up and plane. The boat begins accelerating without adjusting the throttle as less of the boat is dragging in the water. Trimming up causes the engine RPM to increase. It is very important to watch the engine tachometer to keep it at or near full throttle operating range and not to exceed the engine's wide-open throttle operation range. See the *Engine Operator's Manual* for the engine's wide-open throttle operation range.

- To find the optimum trim position while under way, run your boat at a stable planed angle with the least possible amount of the hull in the water. The boat reaches optimum trim position when it is not porpoising or plowing excess water.

High-speed operation on smooth water provides stability, but you must maintain control by using quick reactions and adjustments. Know your limits and stay within them. Keep one hand on the helm and the other on the throttle controls at all times.

WARNING! If you lose control of your boat, pull back on the throttle and trim in at the same time.

Constant adjustments are necessary for rapidly changing conditions. Small inputs of throttle and steering are exaggerated at high speeds. Depending on the speed, keep watch well ahead so that you have enough time to react.

If your boat has trim tabs, you can achieve further boat trim adjustment by using the trim tabs in conjunction with the engine power trim equipment.

Docking

Practice leaving and approaching the dock to become familiar with the procedures.

Helpful guidelines when departing from the dock:

- Make sure you have sufficient space to maneuver your boat away from the dock, other boats and any other obstacles that may hinder your departure.
- Always allow sufficient clearance to the stern for the engine to clear any obstructions.
- Be aware of other boat traffic, wind and water conditions before departing.
- Make sure the engine is started and you have boat movement under control before casting off any mooring lines.
- Always proceed slowly when departing from a dock.



Section 7

Helpful guidelines when docking:

- Make sure you have sufficient space to maneuver your boat around the dock, other boats and any other obstacles that may hinder your approach.
- Be aware of other boat traffic, wind and water conditions on your approach.
- Always approach from a direction against the wind or current.
- When possible, approach slowly from a 45-degree angle and then steer parallel to the dock.
- Have fenders, mooring lines and assistance ready. **WARNING! Never use your hand, arm or any other part of your body to attempt to keep your boat from hitting the dock. The boat could push against the dock, causing severe injury.**
- If possible, throw a mooring line to a person on the dock and have that person secure the bow. With the bow secure, swing the stern in with the engine or pull it in using a boat hook or the stern line.
- Tie off the bow and then the stern.

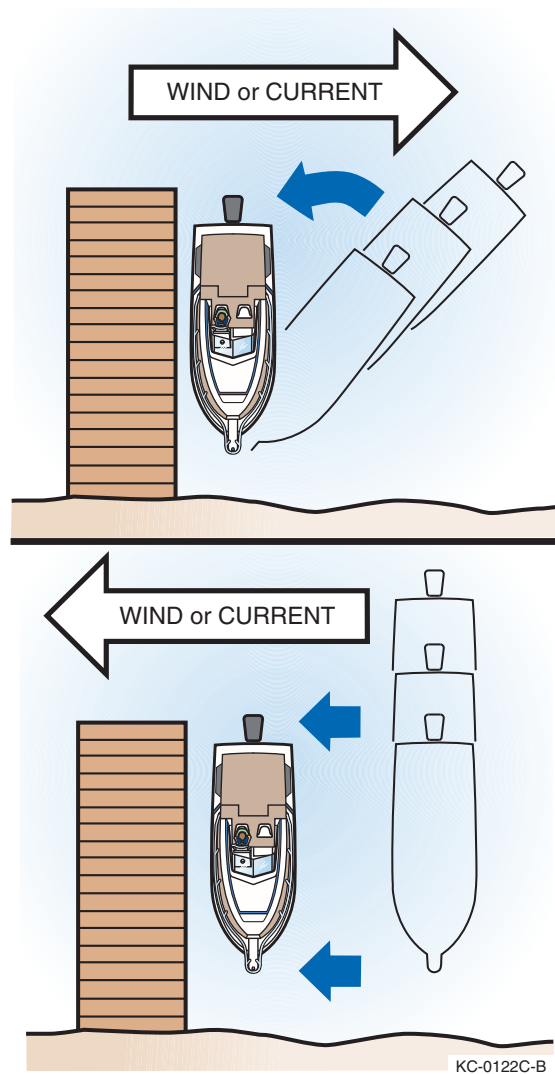

Figure 7-11

Mooring

Because mooring configurations vary, consult with other experienced boaters or qualified boating authorities for recommendations on properly mooring your boat. Always moor your boat securely to prevent personal injury or property damage.

Helpful guidelines when mooring:

- Each mooring line must be of the appropriate strength, material and type to safely secure your boat when moored.
- Each mooring line must be longer than the length of your boat.
- Use bow and stern mooring lines, as well as spring lines, for additional security.



Operating Your Boat

- Use fenders to protect your boat from damage.
- When possible, tie up with the bow facing into the wind or current.
- Never attach a mooring line to a point or part of your boat that is not designed to withstand the stress and the weight of the boat.
- Only use the bow eye, stern eyes and other cleats or attachment points that have been approved for mooring.
- If you plan on mooring your boat for a long period of time, use chafing protectors on lines to protect the boat's finish.
- Leave some slack in the lines to allow for wave movement or tidal action if applicable.

Anchors and Anchoring

Anchors are available for various applications and come in many sizes, types and shapes. Boat weight and size are primary factors in choosing an anchor. When selecting an anchor, consult other qualified boaters or local marine authorities.

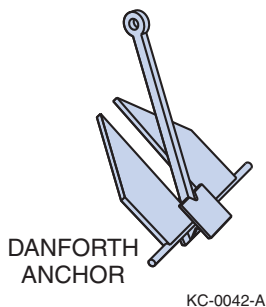

Figure 7-12

Anchor line (rode) is constructed from various materials and is available in many diameters and types. Consult with your local marine supply store for a recommendation on appropriate lines for your boat anchor and application. For most applications, anchor line length should be at least six to seven times longer than the depth of the water in which you are anchoring. Always have plenty of additional anchor line on-board.

WARNING! ALWAYS anchor from the bow; NEVER anchor from the stern. A small amount of current will make a boat unsteady. A strong current can pull a boat anchored by the stern under the water and keep it there.

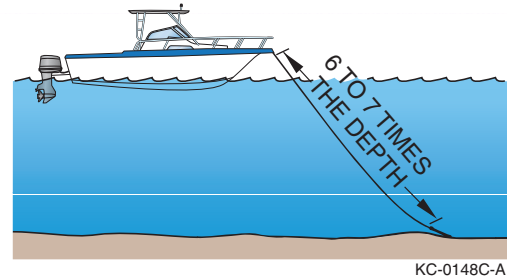

Figure 7-13

Helpful guidelines when anchoring:

- Make sure the anchor line is tied to the anchor. Tie the other end of the line to the forward cleat or bow eye.
- Head your boat into the wind or current over the spot where you want to lower the anchor.
- Stop your boat before lowering the anchor.
- Slowly lower the anchor until it hits bottom.
- Allow the boat to back away, keeping tension on the line.
- Release at least six to seven times as much line as the depth of the water.
- Secure the anchor line to the bow cleat or eye.
- Firmly pull on the line to make sure the anchor is holding.
- Occasionally check your position against the shoreline. If the anchor is dragging and the boat is drifting, reset the anchor.

Helpful guidelines when weighing (pulling in) the anchor:

- Start the engine(s).
- If necessary, move forward until enough tension is off the anchor line to allow for retrieval of the anchor. Avoid running over the anchor line; retrieve the line as you approach the anchor.
- Once the anchor line is straight up and down, lift the anchor from the bottom.
- If the anchor is stuck, attach the anchor line to the bow cleat so that it is tight. The up-and-down motion of the bow from wave action may loosen the anchor from the bottom. If the anchor remains stuck, let out a few more feet of line and attach it to the bow cleat. While keeping tension on the line, slowly maneuver your boat around the anchor to help loosen it. Avoid running over the anchor line.
- Always stow and secure the anchor and line before departing.



Section 7

Lines and Knots

Mooring, anchor and other nautical lines are constructed from many different types of materials, and are available in many diameters and styles. Consult with your local marine supply store for a recommendation of appropriate lines for your boat and application. Commonly used mooring lines are constructed of a high-quality synthetic material in a double-braided configuration and usually have eye splices on at least one end.

Learn and become familiar with tying and using knots. Knowing how to use knots and lines properly can prevent personal injury and property damage.

Practice tying lines to docks, cleats and anchors, and connecting two lines together. Consult other qualified boaters or local marine authorities, or visit your local bookstore, library or the Internet for information on the proper use of nautical lines and knots. The following illustrations represent a few examples of securing mooring lines.

Securing to piling (clove hitch)

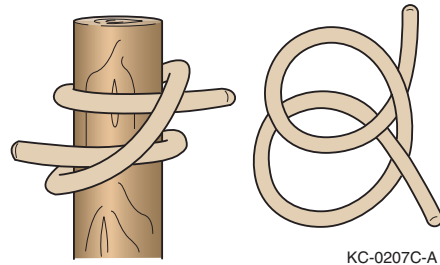

Figure 7-16

Securing to dock bit

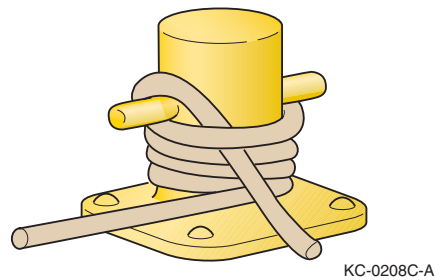

Figure 7-17

Cleating an open line

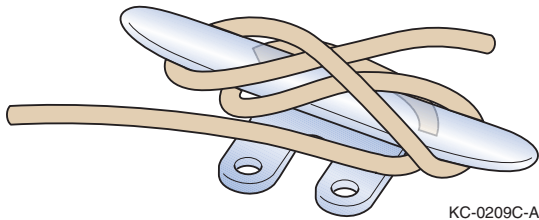

Figure 7-14

Cleating an eye-spliced line

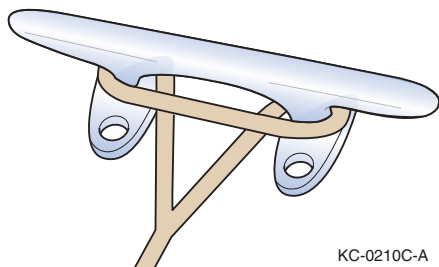

Figure 7-15



Section 8

TRAILERING AND LAUNCHING

Before using your trailer, see *Safety on page 2-1*.

LEGAL CONSIDERATIONS

The following information is intended as a basic guideline only. See the *Trailer Operator's Manual* for information on operation, adjustments and maintenance.

Before you use your trailer, contact your state's Department of Motor Vehicles (and that of other states through which you may be traveling) for information on trailering regulations. Trailer regulations vary widely from state to state, and it is your responsibility to be in compliance with all regulations when trailering your boat.

Regulations include, but are not limited to, trailer registration, licensing, width, height, length, lights, safety chains, tie-downs, hitch type, weight capacity, brakes, spare wheels, vehicle mirrors and gross vehicle weight.

TRAILER CLASSIFICATION

Trailers are separated into four classes based on the Gross Vehicle Weight Rating (GVWR):

Trailer Class	GVWR
Class One	under 2000 lb (907 kg)
Class Two	over 2000 lb (907 kg) and under 3500 lb (1588 kg)
Class Three	over 3500 lb (1588 kg) and under 5000 lb (2268 kg)
Class Four	over 5000 lb (2268 kg)

TRAILER TYPE

Trailers are designed for many applications and can vary in style. To prevent damage to your boat and/or personal injury, always use the appropriate trailer for your boat. Contact your dealer for more information.

TRAILER GROSS VEHICLE WEIGHT RATING

All trailers must display a Gross Vehicle Weight Rating (GVWR) decal, which shows the load-carrying capacity plus the weight of the trailer. The total weight of your boat (fully loaded with fuel, batteries, water, etc.), engine, gear and trailer must never exceed the GVWR.

TOWING VEHICLE

The towing vehicle must be able to safely pull the full trailer and boat load. Never pull a trailer load that exceeds the vehicle's towing capacity; you risk losing control of the trailer and/or vehicle. Before trailering, always check your *Vehicle Operator's Manual* for maximum towing/trailering load specifications and maximum gross vehicle weight specifications that include the fully loaded trailer.

VEHICLE TOWING HITCH

The towing vehicle must be able to safely pull the full trailer and boat load. The vehicle must have a towing hitch that is capable of safely handling the trailering load and tongue weight of the trailer.

Hitches are designed for many applications and can vary in style. Use professional assistance when selecting the correct hitch and hitch ball for your towing application. **WARNING! A vehicle hitch that is underrated or improperly installed can lead to loss of control of the trailer and/or vehicle, causing serious personal injury or even death.**



Section 8

Hitches are divided into classes that specify the trailer's gross trailer weight and maximum tongue weight for each class. **WARNING! Never use a hitch that is not rated to pull the maximum**

weight of your trailering load or that is not rated for the maximum tongue weight that your trailering load applies.

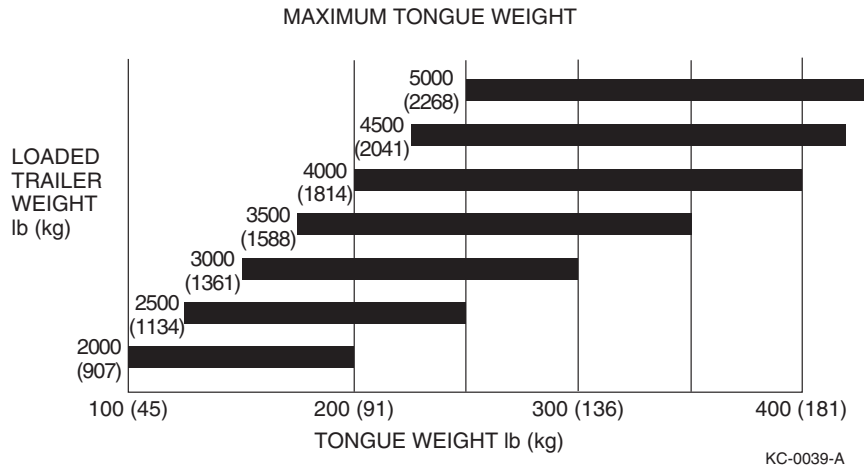

Figure 8-1

HITCH BALL AND TRAILER COUPLER

Most boat trailers have a coupler that connects to a hitch ball attached to the towing vehicle's hitch. The trailer hitch coupler must always match the size of the hitch ball. The correct hitch ball diameter for the coupler is usually marked on the trailer coupler. **WARNING! Never use a hitch ball size or rating that does not match the trailer coupler specifications.**

Trailer hitch balls are sized and rated for use based on the trailer GVWR:

Trailer Class	GVWR	Hitch Ball Diameter Size
Class One	under 2000 lb (907 kg)	1-7/8 in. diameter size
Class Two	over 2000 lb (907 kg) and under 3500 lb (1588 kg)	2 in. diameter size
Class Three	over 3500 lb (1588 kg) and under 5000 lb (2268 kg)	2 in. diameter size
Class Four	over 5000 lb (2268 kg)	2-5/16 in. diameter size

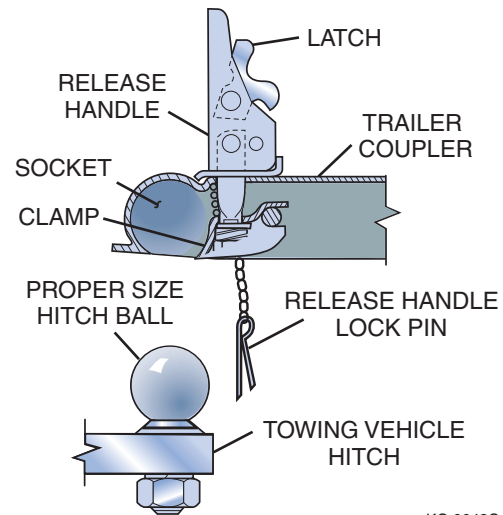

Figure 8-2



Trailer and Launching

SAFETY CHAINS

Your boat trailer's safety chains prevent the trailer from completely detaching from the towing vehicle when under way. Connect the chains to the vehicle's hitch or frame and crisscross the chains under the trailer tongue to prevent the tongue from dropping to the road if the trailer separates from the hitch ball. Rig the chains as tight as possible with enough slack to permit full-free turning. Safety chains must be rated at the same or greater weight capacity as the trailer's GVWR.

Never allow the chains to drag on the ground when trailering.

Attach the chains properly and securely between the towing vehicle and trailer before trailering.

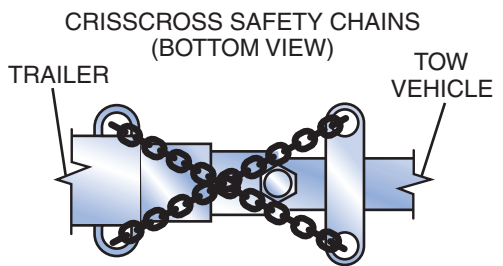

Figure 8-3

TRAILER BRAKES

In some states, any trailer with a GVWR of 1500 lb (680 kg) or more is required to have trailer brakes. Check with your state and local authorities for more information.

The three basic types of trailer brakes are electric, hydraulic surge and air-actuated. If your trailer is equipped with brakes, see the *Trailer Operator's Manual* for more information on operation, adjustments and maintenance.

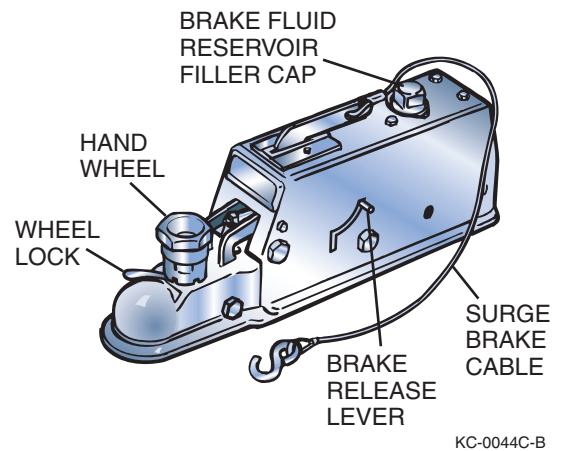

Figure 8-4

5-Pin Wiring Connector

Some trailers equipped with surge brakes may utilize a 5-pin wiring connector. These trailers use an electric solenoid valve that allows brake fluid to bypass back to the reservoir while in REVERSE. The solenoid is usually connected to the reverse lights on the tow vehicle to ensure the brakes only bypass in REVERSE. The fifth pin is for deactivating the brakes when backing up, and is required to be connected to the vehicle's power when backing up. In some instances, the 5-pin connector can be connected to a 4-pin connector for normal operation of the lights.



Section 8

TRAILERING GUIDELINES

Follow these guidelines when trailering:

- Maintain a safe speed as regulated by the trailering laws of the state where you are traveling.
- Check the trailer and vehicle brakes for proper operation and fluid level prior to departure.
- Check the trailer for damage prior to departure.
- Once the trailer is secured to the vehicle hitch, stow the trailer jack or lift so that it will not hit the ground.
- Check the trailer and vehicle tires for proper inflation. Under-inflated tires heat up rapidly and may cause tire damage or failure.
- Check trailer wheel bearings and lug nuts before each trip.
- Secure the stern of your boat to the trailer from the stern eyes.
- Fasten the bow of your boat to the trailer with the bow winch line connected to the bow eye and bow safety chains.

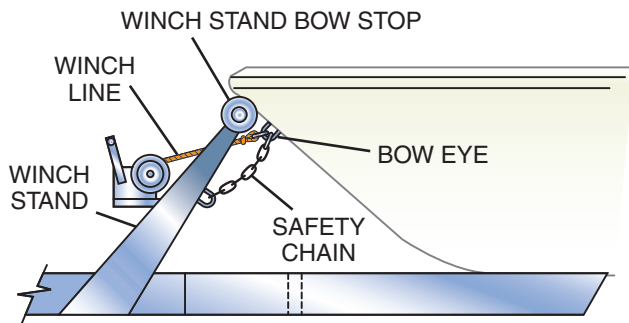

KC-0047C-A

Figure 8-5

- If travel conditions require, use an additional tie-down strap across the rear of your boat from side to side to further secure the stern.
- Check all strapping material for wear.
- Make sure trailer and vehicle running, brake and signal lights are in good working condition.
- Drive with the vehicle and trailer running lights on.
- Too much or too little tongue weight makes steering difficult and causes the tow vehicle to sway. Put approximately 5% to 10% of boat and trailer weight on the tongue.

- Side curtains, backdrop, aft curtains, convertible tops and detachable windshields are not designed to stay on boats at highway speeds. Before towing, take down the convertible top, side curtains, back cover and detachable windshield, if equipped.
- Remove any covers that are not designed to stay on boats at highway speeds.
- Carry a spare tire and wheel for both your trailer and your towing vehicle, along with tools to change them.
- See the *Engine Operator's Manual* for engine-related trailering information. Continuous road shocks may fatigue your boat's steering system.
- On extended trips, carry spare wheel bearings, seals and races.
- While traveling, check the wheel hubs every time you stop. If the hub feels abnormally hot, inspect the bearing before continuing your trip.
- Carry a fire extinguisher in the vehicle.
- Turn carefully while towing a trailer; additional space and distance are needed.

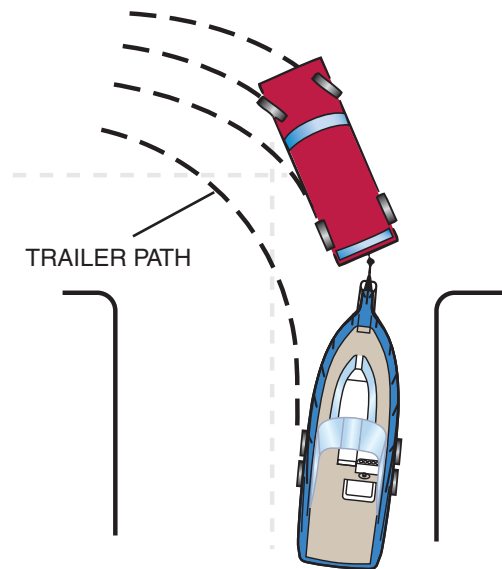

KC-0049C-A

Figure 8-6

- Drive slowly over railroad tracks or rough roads.



Trailer and Launching

- If you trailer your boat from lake to lake, you may unknowingly introduce a foreign aquatic species from one lake to the next. Thoroughly clean your boat below the waterline, remove all weeds and algae, and drain the bilge and livewells before launching it in a new body of water.
- Make sure the hitch ball and trailer coupler are the same size and bolts and nuts are tightly secured.
- The coupler must be completely over the ball, and the latching mechanism must be locked down.
- The safety chains must be attached crisscrossing under the coupler to the frame of the tow vehicle. If the ball was to break, the trailer would follow in a straight line and prevent the coupler from dragging on the road. Make sure the trailer emergency brake cable or chain is also installed to the tow vehicle frame.

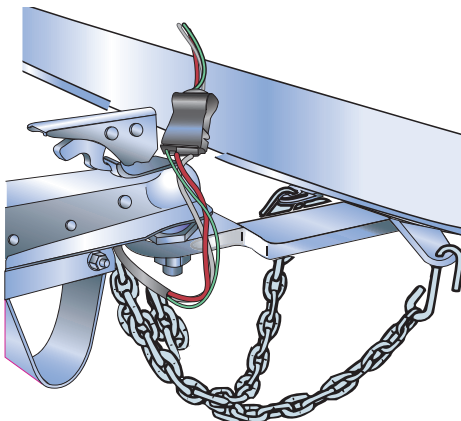

KC-0046C-A

Figure 8-7

- Make sure the lights on the trailer function properly.
- Make sure the tow vehicle has side view mirrors that are large enough to provide an unobstructed rear view on both sides of the vehicle.

Note: Make sure your towing vehicle and trailer are in compliance with all state and local laws. Contact your state motor vehicle bureau for laws governing the towing of trailers.

Backing Up

If you have never towed a trailer before, take time to practice and become comfortable with backing up your boat and trailer. Situations can arise in traffic, or when launching, that will require you to be able to back up your trailer safely.

Follow these guidelines when backing a trailer:

- Back slowly and make small steering adjustments.
- Turn the car wheels in the direction opposite where you want the trailer to go.
- After the trailer begins moving, turn the car to follow it.
- Have a second person assist you with audible and hand signals.

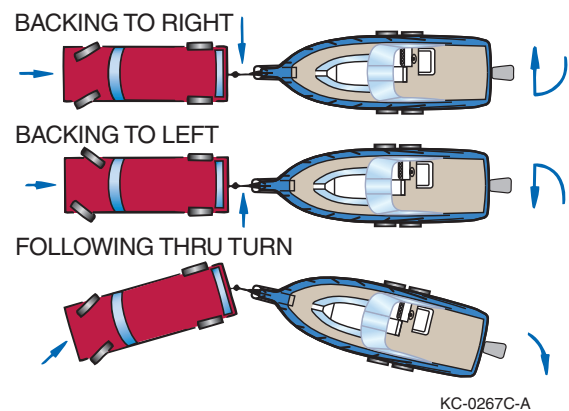

KC-0267C-A

Figure 8-8

LAUNCHING

Before launching, inspect the launch ramp for any problems that may hinder launching or make launching unsafe. Ramps can be slick and dangerous to drive or walk on, and may have unseen drop-offs beneath the water that would pose a safety hazard. Always be aware of water conditions and the effects of the wind when launching.

Before launching, inspect your boat and trailer for damage. Do not launch if you detect damage or find that the engine or propeller is not in good operating condition. Have any repairs made before launching.



Section 8

Use courtesy when preparing your boat for launching by preparing away from the ramp on level ground before proceeding to the launch ramp.

When launching your boat on the trailer, have two or more people assist you. Since all launches are different, the following procedures are intended as guidelines only:

- Verify that your vehicle's brakes, including the parking brake, are in proper working order.
- Make sure the trailer is securely fastened to the vehicle.
- Remove the boat cover, if equipped.
- Check that the bilge drain plug is in place and all other plugs that allow water to leak into the boat are in place.
- Remove all tie-downs from your boat.
- Attach the bow and stern docking lines.
- Attach boat fenders if necessary.
- Disconnect the trailer lights from the car.
- If applicable, trim or tilt the engine/outdrive up to avoid damage.
- Make sure the bow winch and strap are securely locked and fastened.
- Make sure the bow winch safety chains, if equipped, are in place.
- Make sure all required documentation and safety equipment are on-board.
- Verify that batteries are fully charged and in good condition.
- Check fuel level; add fuel if necessary.
- Always launch with the help of another person.
- Make sure there is no one on the ramp behind your boat.
- Keep the trailer/vehicle combination as straight as possible and at 90 degrees to the shoreline.
- Back slowly down the ramp until the transom of your boat is a few inches in the water; then stop the vehicle.
- Stop the vehicle and shift into PARK (automatic transmission) or REVERSE (manual transmission). Apply the brakes and/or parking brake. If possible, use wheel blocks.
- Position the mooring lines within reach of the dock.
- Disconnect the bow winch strap and safety chains, if equipped, from the bow eye.
- Manually back your boat clear of and off the trailer into the water and secure to the dock using mooring lines.
- Remove any wheel blocks and release the vehicle brakes. Pull the trailer slowly out of the water, and secure and park in a designated area.
- Board your boat.
- Lower the engine/outdrive, if applicable.
- Run the bilge blowers as required, if equipped.
- See the *Engine Operator's Manual* for starting procedures.
- Remove dock lines from the dock and proceed slowly away from the dock.

LOADING GUIDELINES

Follow these guidelines while loading your boat onto the trailer:

- When loading your boat on the trailer, have two or more people assist you.
- Stop, turn off the engine and secure it to the dock with dock lines at a position clear from where the trailer will be in the water.
- If applicable, trim or tilt the engine/outdrive up to avoid damage.
- Verify that your vehicle's brakes, including the parking brake, are in proper working order.
- Disconnect the trailer's light harness from the tow vehicle.
- Make sure the trailer is securely fastened to the vehicle.
- Back the trailer slowly down the ramp until it is positioned so that your boat can be loaded.
- Stop the vehicle and shift into PARK (automatic transmission) or REVERSE (manual transmission). Apply the brakes and/or parking brake. If possible, use wheel blocks.
- Position the mooring lines within reach of the dock.
- Manually position your boat onto the trailer using mooring lines. Make sure it is centered on the supports of the trailer.
- Position the bow eye into the bow stop and connect and secure the bow winch strap and safety chains, if equipped, to the bow eye.
- Secure the mooring lines inside your boat.



Trailering and Launching

- Remove any wheel blocks and release the vehicle brakes. Slowly pull the trailer and boat up the ramp.
- Secure the transom to the trailer.
- Prepare for trailering as necessary.

TRAILER TIRES

NOTICE: Tire manufacturers are required by law to collect and maintain customer information in the event of a tire recall. Be sure to fill out the tire registration form completely and mail it to the tire manufacturer.

Information Contained on the Sidewall of the Tire

Both U.S. and Canada federal regulations require tire manufacturers to place standardized information on the sidewall of all tires. This information identifies and describes the characteristics of the tire.

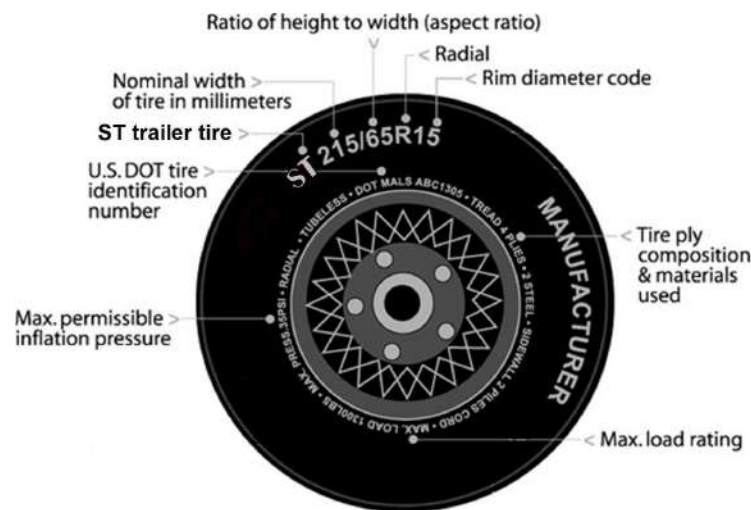

Sidewall Information

Figure 8-9

Maximum Permissible Inflation Pressure

Indicates the tire manufacturer's maximum permissible pressure and/or the pressure at which the maximum load can be carried by the tire. Refer to the certification label on the port forward half of the trailer for the correct tire pressure for your trailer.

U.S. DOT Tire Identification Number (TIN)

This begins with the letters "DOT" and indicates the tire meets all federal standards. The next two numbers or letters are the plant code designating where it was manufactured, the next two are the tire size code, and the last four numbers represent the week and year the tire was built. For example, the numbers 5110 mean the tire was built the 51st week of 2010. The numbers are

identification codes used for traceability. This information is used to contact customers if a tire defect requires a recall.

ST: Indicates the tire is a special tire for trailers in highway service.

215: Indicates the nominal width of the tire in millimeters from sidewall edge to sidewall edge. In general, the larger the number, the wider the tire will be.

65: Indicates the aspect ratio, which gives the tire's ratio of height to width.

R: Indicates a "radial" type tire.

15: Indicates the wheel or rim diameter in inches.



Section 8

Tire Ply Composition and Materials Used

Indicates the number of plies or the number of layers of rubber-coated fabric in the tire tread and sidewall. Tire manufacturers also must indicate the ply materials in the tire and the sidewall, which include steel nylon, polyester and others.

Maximum Load Rating

Indicates the maximum load in kilograms and pounds that can be carried by the tire. Refer to the certification label on the port forward half of the trailer for the correct tire pressure for your trailer. **NOTICE: Manufacturer's Tire Registry:** Be sure to fill out the tire registration form provided with your owner's packet. Mail it to the tire manufacturer for the purpose of federal defect notification regulations.

B-193 (1-05)
701-100-298

IMPORTANT

In case of a recall, we can reach you only if we have your name and address. You **MUST** send in this card to be on recall list.
Do it today.

SHADED AREAS MUST BE FILLED IN BY SELLER

CUSTOMER'S NAME (PLEASE PRINT)	TIRE BRAND												
	QTY	TIRE IDENTIFICATION NUMBER											
CUSTOMER'S ADDRESS	1	2	3	4	5	6	7	8	9	10	11	12	13
CITY STATE ZIP CODE													
NAME OF DEALER WHICH SOLD TIRE													
DEALER'S ADDRESS													
CITY STATE ZIP CODE													
DEALER NON-SIG #													

8890460061

Sample Tire Registration

Figure 8-10

Inflating Your Tires

Safe operation of your trailer requires that your tires are properly inflated. Remember that a tire can lose up to half of its air pressure without appearing flat. Before each trip, check your tires with a tire gauge, including the spare (if equipped). Inflate all tires to the inflation pressure

recommended on the certification label located on the port side of the forward half of the trailer. Failure to follow the tire pressure recommendations can cause uneven treadwear patterns and adversely affect the way your trailer handles.

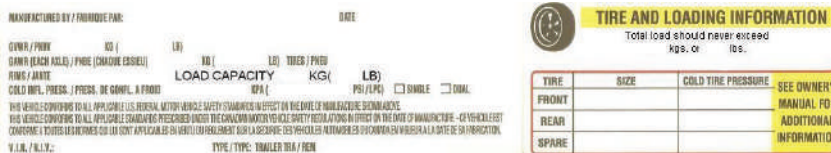

Certification Label and Tire Label

Figure 8-11



Trailer and Launching

When weather temperature changes occur, tire inflation pressures also change. A 10°F (6°C) temperature drop can cause a corresponding drop of 1 psi (7 kPa) in inflation pressure.

CAUTION! Under-inflation is the most common cause of tire failures and may result in severe tire cracking, tread separation or “blowout,” with unexpected loss of vehicle control and increased risk of injury.

Under-inflation increases sidewall flexing and rolling resistance, resulting in heat buildup and internal damage to the tire. It also may result in unnecessary tire stress, irregular wear, loss of vehicle control and accidents. A tire can lose up to half its air pressure and not appear flat!

To check the pressure in your tire(s):

1. Check your tire(s) when they are “cold.” The term cold does not relate to the outside temperature. Rather, a cold tire is one that has not been driven for at least 3 hours. When you drive, your tires get warmer, causing the air pressure to increase. Therefore, to get an accurate tire pressure reading, you must measure the tire pressure when the tires are cold or compensate for the extra pressure in warm tires.
2. Remove the cap from the valve on one tire, then firmly press the tire gauge onto the valve and measure the pressure with the tire gauge.
3. Add (or remove) enough air to reach the recommended air pressure indicated on your certification label.
4. Replace the valve cap.
5. Repeat this procedure for each tire, including the spare.

NOTICE: Use a high-quality tire gauge with a sufficient pressure range and a design that allows you to reach and fully seat the gauge on the tire valve, including the spare. A gauge with a bleed valve is handy for over-inflated tires. For your safety, tires that are damaged or show signs of excessive wear should not be used because they are more likely to blow out or fail. Improper or inadequate trailer maintenance can cause tires to wear abnormally. Inspect your tires, including the spare, frequently, and replace them if one or more show signs of damage or excessive wear.

Tire Care

Periodically inspect the tire treads for uneven or excessive wear and remove objects such as stones, nails or glass that may be wedged in the tire grooves. Check for holes or cuts that may permit air leakage from the tire, and make necessary repairs. Also inspect the tire sidewalls for cracking, cuts, bulges, and other signs of damage or excessive wear. If internal damage to the tire is suspected, have the tire demounted and inspected in case it needs to be repaired or replaced. **CAUTION! Tires degrade over time, even when they are not being used. It is recommended the tires generally be replaced after 6 years of normal service. Heat caused by hot climates or frequent high loading conditions can accelerate the aging process. You should replace the spare tire when you replace the other tires due to the aging of the spare tire.**

Load-Carrying Capacity

The certification label shows the maximum load-carrying capacity and is located on the port forward side of the trailer.

GVWR is the Gross Vehicle Weight Rating. It is the total combined weight of the trailer and its maximum load-carrying capacity. **DO NOT** exceed the GVWR rating for the trailer.

Total Load is the maximum load-carrying capacity of the trailer minus the weight of the trailer.

Locate the statement “Total load should never exceed XXX kg or XXX lbs.” on your trailer’s tire label located on the port forward side of your trailer.

This figure equals the available amount of the boat with all equipment, gear, fuel, water and luggage load capacity.

Determine the combined weight of the boat with all equipment, gear, fuel, water and luggage being loaded on the trailer. That weight may not safely exceed the tire label’s total load.



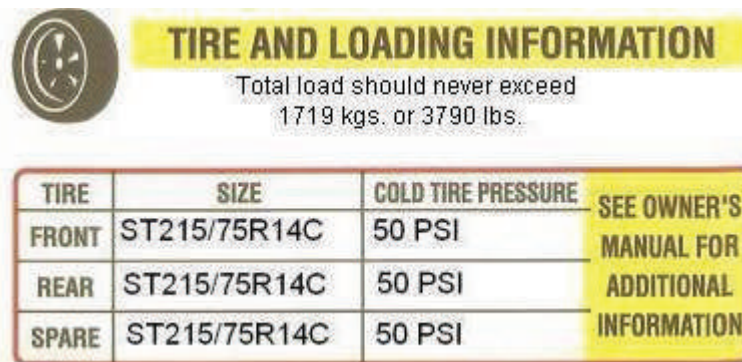

Sample Tire Label

Figure 8-12

Improper weight distribution can place excessive strain on the towing vehicle and trailer. It can also cause the trailer to “fishtail” (sway side to side). Be sure gear and luggage are distributed evenly in the boat.

Glossary of Tire Terminology

Bead: Area of the tire that seats to the rim and provides a seal.

Cold tire pressure: The tire pressure when the trailer has been stationary and out of direct sunlight for an hour or more and prior to the trailer being pulled 1 mile (1.6 km).

Inflation pressure: A measure of the amount of air in a tire.

kPa: Kilopascal, a metric unit of air pressure.

PSI: Pounds per square inch, a standard unit of air pressure.

Recommended inflation pressure: The cold inflation pressure found on the certification label or tire label located on the port forward side of the trailer.

Rim: The metal support (wheel) for a tire upon which the tire beads are seated to provide a seal.

Sidewall of the tire: Area between the bead area and the tread.

Tire Identification Number (TIN): A number on the sidewall of each tire providing information about the tire brand, manufacturing plant, tire size and date of manufacture. It is also referred to as the DOT code.

Tire label: A label on the trailer showing the tire sizes, recommended inflation pressure and the maximum weight the trailer can carry.

Tread area of the tire: Area of the perimeter of the tire that contacts the road when mounted on the trailer.

REPORTING SAFETY DEFECTS

If you believe that your vehicle has a defect which could cause a crash or could cause injury or death, you should immediately inform the National Highway Traffic Safety Administration (NHTSA) in addition to notifying the trailer manufacturer.

If NHTSA receives similar complaints, it may open an investigation, and if it finds that a safety defect exists in a group of vehicles, it may order a recall and remedy campaign. However, NHTSA cannot become involved in individual problems between you, your dealer or the trailer manufacturer.

To contact NHTSA, you may call the Vehicle Safety Hotline toll-free at 1-888-327-4236 (TTY: 1-800-424-9153); go to <http://safercar.gov>; or write to Administrator, NHTSA, 400 Seventh Street SW, Washington, DC 20590. You can also obtain other information about motor vehicle safety from <http://www.safercar.gov>.



Section 9

BOAT FEATURES AND OPTIONS

Before operating any systems within this section, see *Safety* on page 2-1.

Your boat may be equipped with a variety of systems to operate your boat and to provide other conveniences you may need while on the water. The following basic and typical information may not apply to your specific application. All of your boat's systems may not be covered in this section. See the *Manufacturer's Operator's Manual* for specific details.

Regularly inspect and maintain all components and systems to prevent unexpected hazards due to worn or faulty components. Be sure to replace components and hardware with marine-grade parts. Never use automotive components.

FUEL SYSTEM

The basic fuel systems consist of one or more fuel tanks, tank vents, level sensor and gauge, lines, pumps and valves.

Each tank has an antisiphon valve to prevent fuel from leaking out of the tank should a break occur in the system at a point other than the tank. Some models are also equipped with a fuel shutoff valve at each tank to stop fuel flow from the tank. It is recommended that fuel shutoff valves be closed during long periods of inactivity or storage. If equipped with multiple tanks, the system also includes a fuel tank selection valve for individual tank selection and a fuel manifold. The manifold is usually located in the engine compartment and contains a series of fuel feed valves for controlling fuel flow/shutoff to the engines. The fuel valves can be used to help maintain even weight distribution in the fuel tanks for proper boat load distribution or to shut off contaminated fuel from the system. Refer to your boat and *Engine Operator's Manual* for specific fuel system information and service information.

ENGINE LUBRICATION SYSTEM

Depending on engine type, your boat may feature one of several engine lubrication systems. Stern drive engines, like automotive engines, use a sump system where the engine oil is contained in the engine. See the *Engine Operator's Manual* for engine oil recommendations and information.

ENGINE COOLING SYSTEM

Most outboard engines are cooled by using raw water to transfer heat from the engine and then returning the raw water to the sea/lake. A raw water pickup and screen on the lower drive unit allows water into the engine. A pump then circulates the water to cool the engine. Be sure to periodically inspect the intake screen and clear it of any debris which could obstruct water flow into the engine. A continuous discharge of water from the cooling water check port while the engine is running is a visual indication that the engine's cooling system is operating properly. **NOTICE:** *to prevent engine damage, DO NOT run it with the lower drive unit raw water intake above the waterline or out of the water.*

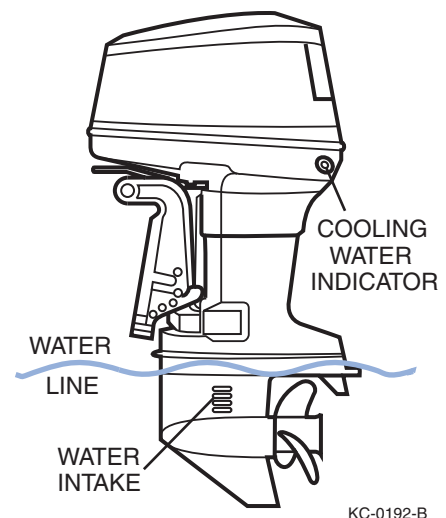

Figure 9-1



Section 9

STEERING SYSTEM

Steering systems vary in type and operation. The most common steering systems are mechanical, power-assisted and hydraulically operated.

Boat steering controls are not self-centering. Always keep a secure grip on the steering wheel to maintain full boat control.

Mechanical steering helm controls transfer the rotary motion of the steering wheel to linear cable motion, which pushes or pulls the engine's steering arm. Some boats are equipped with two mechanical cables to provide positive steering control and additional safety in case one cable fails.

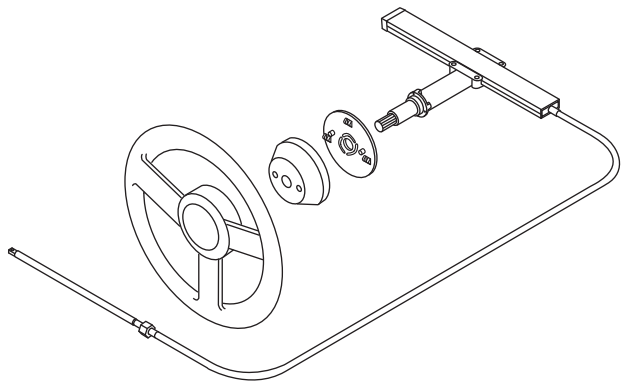

KC-0268-A

Figure 9-2

Power-assisted mechanical systems use hydraulic force to assist the manual rotary motion of the helm's movement, providing easier steering for the operator.

Hydraulic systems use hydraulic pressure from a pump connected to the helm to move hydraulic fluid through hoses, and then to move hydraulic cylinders connected to the engine's steering arm. A reservoir, either separate or integral to the pump, holds extra fluid and maintains a pressure head to prevent air from entering the system.

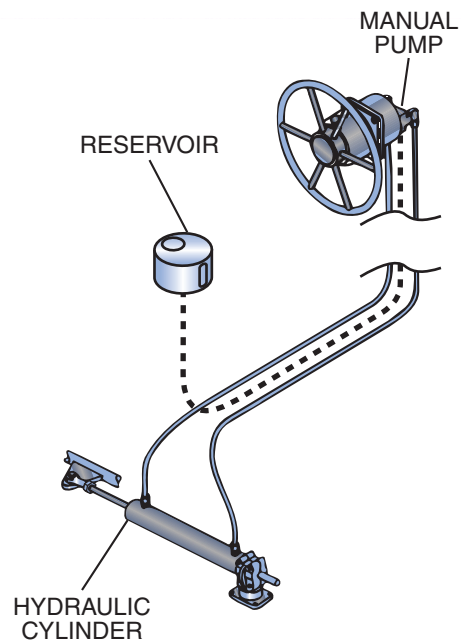

KC-0170-A

Figure 9-3



Boat Features and Options

SHIFT AND THROTTLE CONTROLS

Knowing how to operate the shift and throttle controls of your boat is essential for safe and proper operation.

The following basic and typical information may not apply to your specific shift control. See the *Engine Operator's Manual* or control manufacturer's instructions for information on your throttle and shift control operation, adjustment and maintenance.

Single-Lever Controls - Single or Twin Engine

Single-lever controls operate both the gear shift and the throttle for one engine with one control lever. Single-lever controls can be used on single- or twin-engine boats.

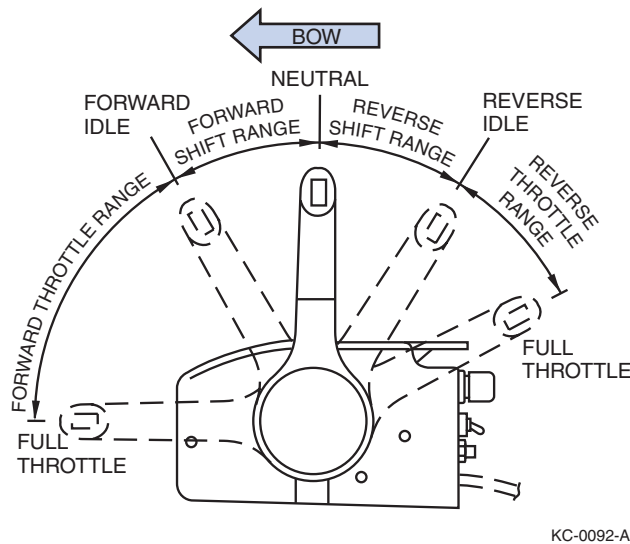

Figure 9-4

Twin-engine boats with single-lever controls have two levers: a left lever for port engine control and a right lever for the starboard engine. Two levers enable you to operate one engine in FORWARD and the other in REVERSE for easier maneuvering in tight quarters.

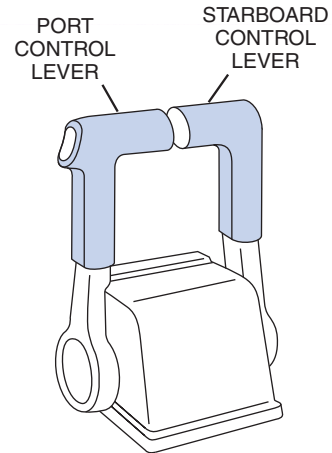

Figure 9-5

- **NEUTRAL** - The lever is detented in the NEUTRAL position (center of travel) for starting; the neutral safety switch allows starting in this position only. For engine warm-up, a separate lever or button on the control is used to disengage the shift cable and allow the throttle to advance only while the transmission remains in NEUTRAL.
- **FORWARD** - Release the detent lock to allow shifting to the FORWARD position. Moving the lever into the first 15° of travel (toward the bow or up) positions the control in the FORWARD detent IDLE position. Advancing the lever beyond 15° allows throttle increase in FORWARD.
- **REVERSE** - Release the detent lock to allow shifting to the REVERSE position. Moving the lever into the first 15° of travel (toward the stern or down) positions the control in the REVERSE detent idle position. Advancing the lever beyond 15° allows throttle increase in REVERSE.



Section 9

Dual-Lever Controls - Single or Multiple Engine

Dual-lever controls have individual levers for gear shifting and engine throttle. Dual-lever controls can be used on single- or twin-engine boats.

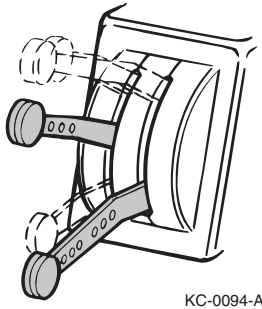

Figure 9-6

Shift levers: NEUTRAL is the detent position in the center of the lever's travel. Pushing the lever toward the bow or up shifts the transmission into FORWARD; pulling the lever toward the stern or down shifts the transmission into REVERSE.

Throttle levers: Full-throttle position is all the way toward the bow or up. Idle position is all the way toward the stern or down.

For engine warm-up, the shift levers are positioned in NEUTRAL and the throttle levers are advanced as needed. For best results when maneuvering at slow speed, operate one engine in FORWARD and the other in REVERSE.

Control Operation Guidelines

WARNING! Improperly maintained controls are hazardous and may cause sudden loss of control. Make sure all shift/throttle hardware and cables are regularly inspected and maintained. Improper maintenance may result in a loss of control, resulting in serious injury or death.

- Side mount throttle and shift controls have a neutral detent locking lever that must be released before shifting from NEUTRAL.
- Always use a brisk and decisive movement when shifting into or out of gear.

- Always pause in NEUTRAL before shifting from FORWARD to REVERSE, or REVERSE to FORWARD. Most throttle and shift controls have a detent position for NEUTRAL, FORWARD and REVERSE engagement positions. Engine damage may occur if you rapidly shift into gear without pausing in these detent positions or allowing the engine RPM to lower into the approved shifting range.
- When traveling at high speed, never shift into REVERSE while your boat is in FORWARD gear.
- Always keep the shift control clean and clear of obstructions. *NOTICE: All shift and throttle controls are equipped with a safety switch for start-in-gear prevention. Place the control in the NEUTRAL position before you attempt to start the engine.*
- Never attempt to shift when the engine is not running.

ELECTRICAL SYSTEM

Boats may be equipped with one or two types of electrical systems: Direct Current (DC) and Alternating Current (AC).

Most boats use a battery-powered direct current (DC) system; some boats also use a generator or shore-powered alternating current (AC) system. Most systems have a main load panel which serves as the main distribution panel.

DC System

Most boats use a 12-volt common negative ground DC system. DC systems are usually the primary electric supply for lights, pumps, blowers, engine starting, etc.

Boats require at least one battery per engine. Multiple-battery systems consist of a cranking battery for each engine and additional batteries that supply auxiliary power to DC electrical circuits.

Battery switches control battery power distribution and disconnect the batteries from the boat's electrical system. The engine's charging system charges batteries connected to the charging system when the engines are running.



Boat Features and Options

Battery isolators prevent accessory loads and other batteries from depleting power from charged batteries. Isolators also allow the engine's charging system to isolate the alternator charging output and distribute the charge among all batteries according to individual need.

The main DC control panel may feature a voltmeter, battery test switch, fuses, circuit breakers and a master breaker switch.

WARNING! Never reset a breaker that has been automatically tripped without first identifying and correcting the cause of the problem. A fire could result.

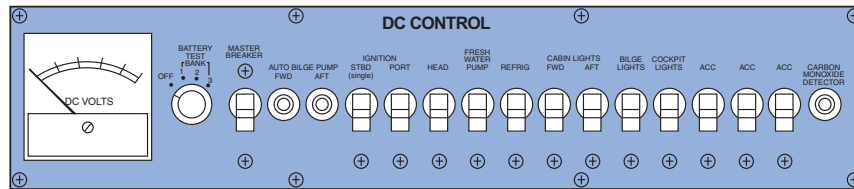

TYPICAL DC CONTROL PANEL

KC-0155-A

Figure 9-7

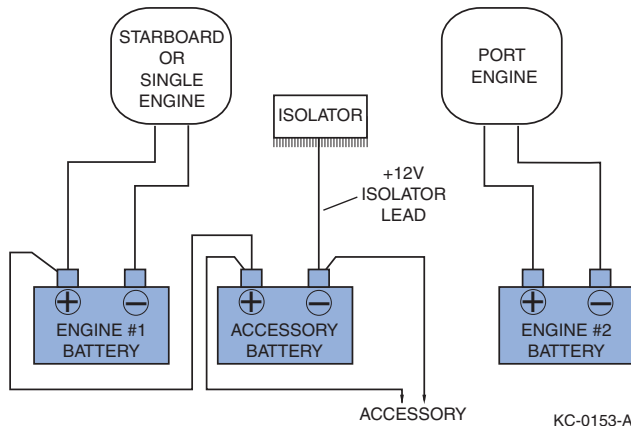

Figure 9-8

systems rely on shore power or on-board AC generators. **NOTICE: NEVER modify or repair a boat's AC power system or components. Always consult a qualified electrician and ensure that repairs or modifications are in compliance with ABYC guidelines and National Electrical Codes.**

AC shore power systems are normally rated for 125 volts at 60 cycles. Source current is provided by a 110-volt, 60-cycle shore power station.

The AC control portion of the AC generator control panel may include the following components:

AC systems supply AC electrical power to equipment and outlets requiring AC power, such as electric stoves, water heaters, microwaves and refrigerators. AC systems are normally used when your boat is moored to a dock or slip. AC



Section 9

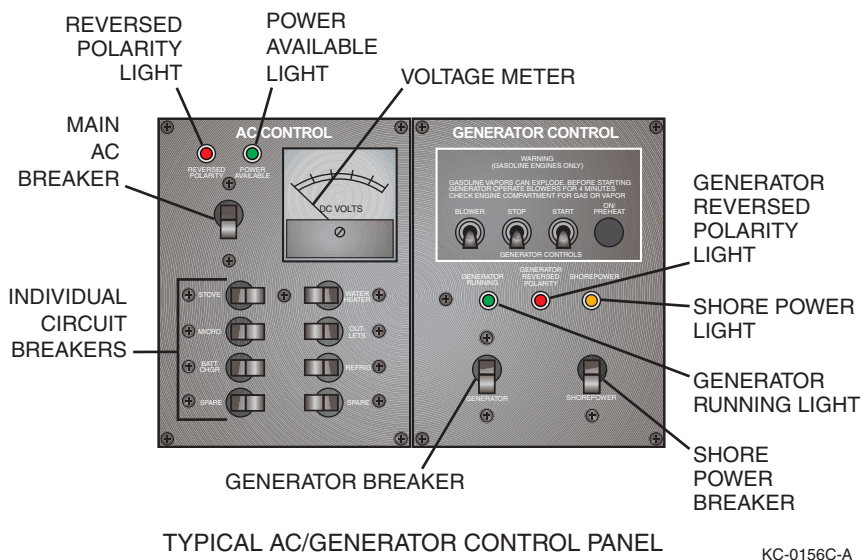

Figure 9-9

Voltmeter – Allows you to monitor the system AC voltage. Damage to components can occur if voltage entering the system is less than the minimum operating voltage. **Reverse Polarity Light** – Indicates if the polarity of the shore power source has been reversed, but will not indicate if the boat polarity (wiring) is reversed. **WARNING! If a reverse polarity warning is indicated, do not use the shore power source. Immediately turn off the power source onshore and disconnect the shore power cord. See Safety Precautions at the beginning of this section for more details.** **Power Available Light** – Indicates that power from the shore or from the generator is available to the panel for distribution. This indicator must be illuminated before you switch the main AC breaker on. **Main AC Circuit Breaker** – Provides overload protection for all circuits on the panel and allows the connection and disconnection of AC power to all individual circuits. **Individual Circuit Breakers** – Provide overload protection for an individual circuit and allow the connection and disconnection of AC power to individual circuits. **WARNING! Never reset a breaker that has been automatically tripped without first identifying and correcting the cause of the problem. A fire could result. See Safety Precautions at the beginning of this section for more details.** The generator control portion of the AC generator control panel may include the following components:

Generator Main Circuit Breaker – Provides overload protection for all circuits on the panel and allows the connection and disconnection of generator AC power to all individual circuits. Never switch the breaker while the generator is running. **Shore Power Breaker** – Provides overload protection for all circuits on the panel and allows the connection and disconnection of AC shore power to all circuits. **Generator Running Light** – Indicates that generator power is being received by the AC control panel. **AC Shore Power Light** – Indicates that shore power is being received by the AC generator control panel. All shore power systems require a special marine-grade, three-conductor cable to make a proper connection to the shore. Cables and connection types are rated by their current-carrying ability in amperes. Dockside connections are plug-in, while boat-side connections plug in and lock into position with a threaded locking collar to prevent accidental disconnection and to provide water resistance. Always obtain authorized assistance when selecting cables and adapters, or when connecting to power. **WARNING! Plugs and receptacles are not interchangeable between systems. A plug from one system cannot fit into the receptacle of another system. Never attempt to modify a shore power cable; use only commercially available adapters for**



Boat Features and Options

system modification. See Safety Precautions at the beginning of this section for more details.

Use the following guidelines to minimize shock and fire hazards when connecting and disconnecting shore power cables.

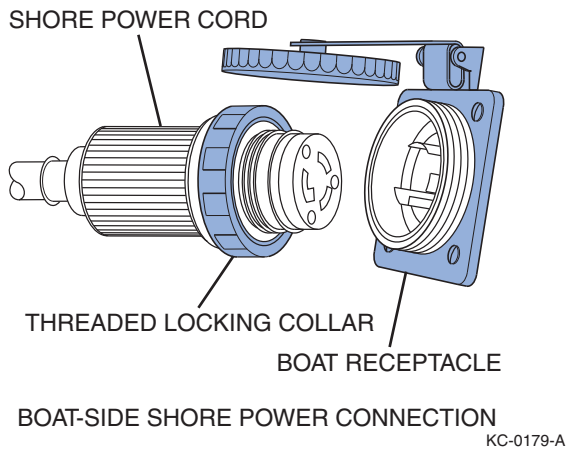

Figure 9-10

To connect:

- Shut down the generator if applicable. Turn off the generator breaker and the main AC breaker.
- Turn off your boat's main AC breaker switch.
- Turn off the dock or shore outlet switch.
- Connect the shore power cable to the boat connection.
- Make sure the cable has more slack than the mooring lines and cannot drop into the water.
- Remove the cap from the outlet on the pier and connect the other end of shore cable to the outlet on the pier.
- Turn on the dock or shore outlet switch.
- Check the reversed polarity light. If it is on, immediately disconnect the cable.
- Turn the AC main or shore circuit breaker switch to the ON position.
- Turn the AC main panel circuit breaker switch to the ON position.
- Turn individual circuit breakers on.

To disconnect:

- Turn the AC main panel circuit breaker switch to the OFF position.
- Turn the AC main or shore circuit breaker switch to the OFF position.

- Turn off the dock or shore outlet switch.
 - Disconnect the shore power cable at the shore outlet.
 - Disconnect the power cable from your boat. Replace the cap over the inlet.
 - Place the cable in storage for future use.
- WARNING! Some marinas have been known to “break” shore power ground circuits to prevent electrolysis. Opening the ground circuit creates a potentially dangerous on-board shock hazard. Ensure that your shore power cable ground circuit is always continuous. See Safety Precautions at the beginning of this section for more details.**

PROPELLERS

The following basic information may not apply to all engines. See the *Engine Operator's Manual* for information on propellers for your boat. Consult your local marina or certified marine technician for assistance when replacing or servicing propellers.

The propeller converts the engine's power into the thrust needed to propel the boat. Care and selection of your propeller is very important for proper boat operation. Propeller size is usually identified by two numbers, such as 13 x 19, and a material identification, such as aluminum or stainless steel. In the number sequence, the first number is the diameter of the propeller in inches and the second is the pitch in inches.

Pitch is the angle of the blades expressed in the theoretical distance a propeller travels in each revolution. In the previous example, the pitch is 19, which means that each revolution of the propeller pushes the boat 19 inches (483 mm) through the water.

Propellers on boats powered by outboard or stern drive propulsion systems are usually replaced out of the water to prevent loss of parts and to ensure correct installation. Although propeller replacement can be completed with the boat in the water, it is not recommended. Remove an inboard-powered boat from the water for propeller replacement because the propeller is not accessible while the boat is in the water. Special tools are required for most applications. Always



Section 9

consult your local marina or certified marine technician for assistance when replacing or servicing propellers.

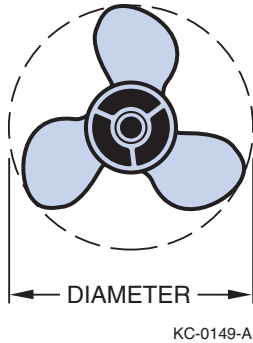

Figure 9-11

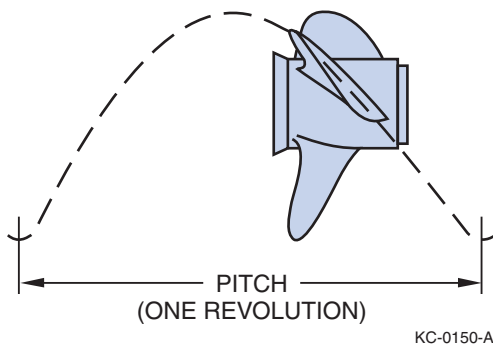

Figure 9-12

Propeller Selection and Replacement Guidelines

There are many different propeller designs for specific operating characteristics. Always consult a certified marine technician when replacing your propeller.

To prevent accidental start-up, complete the following before installing or removing the propeller:

- Position the shift control in NEUTRAL.
- Position the battery switch to the OFF position and remove the key.
- Place a wood block between the cavitation plate and the propeller to hold the propeller in place. Remove the propeller nut. **WARNING! Never use your hand to hold the propeller when removing the propeller nut.**

Automatic fire extinguishing systems are self-contained systems that are designed to automatically activate to help extinguish fires.

These systems include the extinguishing material, lines, nozzles, valves, sensors, controls and indicators.

In the event of an extinguisher discharge, immediately shut down all electrical and mechanical systems and powered ventilation. Automatic fire extinguishing systems are added protection to your safety and your boat's fire protection, but do not eliminate the need for hand held U.S. Coast Guard approved fire extinguishers. See the *Automatic Fire Extinguishing Systems Operator's Manual* for specific operation and service information.

WARNING! If the fire system discharges, wait for at least 15 minutes before opening engine hatch. Fire system gas displaces oxygen to "smother" the fire. Opening the hatch too soon may feed oxygen to the fire and flashback can occur.



Boat Features and Options

GAUGES / INSTRUMENTS

The following basic and typical information may not apply to your specific boat. This section may not cover all gauges on your boat. See the *Engine Operator's Manual* or equipment manufacturer's supplied information on the use and operation of the unique gauges and instruments. Some models may be equipped with a multi-gauge instrument which integrates the functions of several single gauges.

Gauges are visual indicators that help you monitor various system and component operation parameters. Gauges usually have lights integrated into them for visual clarity when operating at night. They are located near the helm area or other main control areas.

Tachometer

The tachometer indicates engine speed in revolutions per minute (rpm). Monitor engine rpm at all times to keep the engine within the proper rpm operating range. See the *Engine Operator's Manual* for the rpm operating range of your engine.

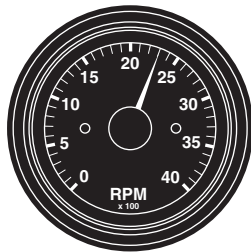

KC-0095-A

Figure 9-13

Speedometer

The speedometer indicates approximate forward boat speed in miles per hour (mph).

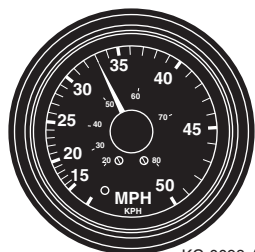

KC-0098-A

Figure 9-14

Fuel Level Gauge

The fuel level gauge indicates approximate fuel level in the fuel tank. The accuracy of the fuel gauge may vary as the attitude of the boat changes; the reading is only an approximation. As a general rule always use the "one third" rule. Use one third of the fuel to reach your destination, one third to return and one third as reserve fuel.



KC-0099-A

Figure 9-15

Engine Water Pressure Gauge

The engine water pressure gauge indicates the water pressure of the engine cooling system in pounds per square inch (psi). This gauge monitors the engine cooling system operation and indicates overheating problems. See the *Engine Operator's Manual* for the normal operating range.

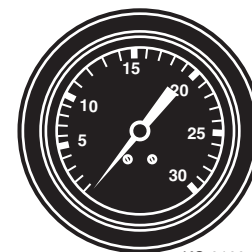

KC-0100-A

Figure 9-16



Section 9

Power Trim / Tilt Gauge

The power trim/tilt gauge indicates the angular position of the lower drive unit and propeller in relation to the transom of the boat.

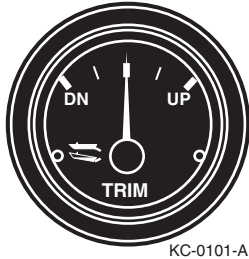

KC-0101-A

Figure 9-17

Voltmeter

The voltmeter indicates the voltage of the main cranking battery in volts DC. See the *Engine Operator's Manual* for the normal operating range.

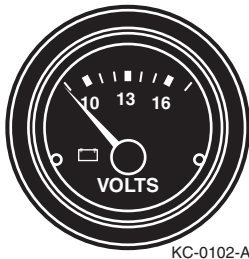

KC-0102-A

Figure 9-18

Engine Water Temperature Gauge

The engine water temperature gauge indicates the water/coolant temperature of the engine cooling system. Most marine engines use seawater to cool the engine. A sudden increase in temperature could be an indication of a blocked cooling passage or a water pump malfunction.

Check the gauge immediately after starting the engine. If the temperature gauge is high, STOP the engine immediately and see the *Engine Operator's Manual* for corrective action.

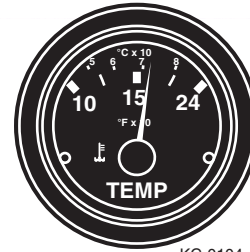

KC-0104-A

Figure 9-19

Engine Synchronization Gauge (Dual Engine Applications)

On twin-engine boats, an engine synchronization gauge can be used to synchronize the engine speed (rpm). This gauge allows the operator to adjust each engine throttle to operate at the same rpm to optimize boat performance. See the manufacturer's information for operating instructions.

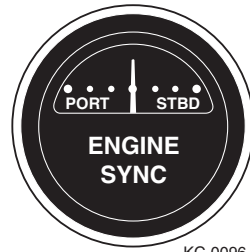

KC-0096-A

Figure 9-20

Engine Hour Meter

The engine hour meter indicates the total number of hours the ignition switch is in the ON position. Under normal conditions, the engine is running when the ignition switch is ON; therefore, the hour meter provides an approximate indication of engine hours. An hour meter is useful in determining scheduled maintenance.

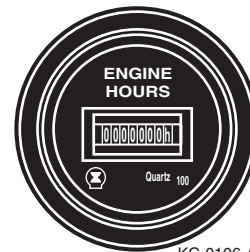

KC-0106-A

Figure 9-21



Boat Features and Options

Oil Level Gauge (Outboard Engine Oil Injection Optional)

The oil level gauge indicates the level of outboard engine oil in the reservoir used for the oil injection system. Some oil injection systems may provide an indicator on the reservoir. See the *Engine Operator's Manual* for additional information.

Water Depth Gauge

The water depth gauge indicates the approximate distance between the bottom of your boat and the earth's surface directly below the transducer. To avoid running aground in shallow water, always add extra distance to meter readings. See the manufacturer's instructions for installation requirements and operating instructions.

Compass

A compass assists in navigation by indicating where approximate north is located. See the manufacturer's instructions for operating instructions.

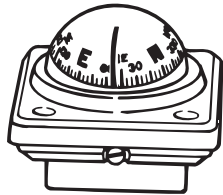

KC-0107-A

Figure 9-22

Engine Warning Alarm System

Your engine may have integrated audible alarms to warn of engine overheating, low oil pressure or other conditions. See the *Engine Operator's Manual* for more information.

Carbon Monoxide (CO) Detector

A carbon monoxide detector is a safety device designed to sound an audible alarm when carbon monoxide is detected in the area of the detector. Carbon Monoxide (CO) gas is colorless, odorless and extremely dangerous. All engines and fuel-burning appliances produce CO as exhaust. CO detectors are recommended in areas where CO build-up is a possibility, especially in boats that have confined areas such as sleeping quarters, galleys and head compartments. Regularly check the condition of the CO detector for proper operation. See the manufacturer's instructions for installation requirements and operating instructions. **DANGER! EXTREME HAZARD - Carbon monoxide (CO) gas is colorless, odorless and extremely dangerous. All engines and fuel-burning appliances produce CO as exhaust. Direct and prolonged exposure to CO will cause brain damage or death.**

Smoke Detector

A smoke detector is a safety device designed to sound an audible alarm when smoke is detected in the area of the detector. Smoke detectors are recommended in areas where fire is a possibility, especially in boats that have confined areas such as sleeping quarters, galleys and head compartments. Regularly check the condition of the detector for proper operation. See the manufacturer's instructions for installation requirements and operating instructions.

Gasoline Fume Detector Indicator

The gasoline fume detector is a safety device designed to sound an audible alarm when gasoline fumes are detected in the engine compartment or bilge area. The sensor for the detector is usually mounted in the bilge area where fumes collect. Test the detector before operating your boat every time to ensure it is working properly. Always turn on the bilge blower to evacuate fumes before starting the engine. See the manufacturer's instructions for installation requirements and operating instructions.



Section 9

If the gasoline fume detector indicates a dangerous condition:

- Turn on the bilge blower.
- Do not operate electrical equipment.
- Extinguish open flames and smoking materials immediately.
- Turn off the engine.
- Wait five minutes before opening the engine compartment to investigate the cause.
- Correct the problem immediately before resuming operation.

HELM AND CONTROL SWITCHES

The following information is intended as basic and typical and may not apply to your specific application. Not all switches may be covered in this section. See the *Manufacturer's Operator's Manual* for specific information on the use and operation of switches in your boat.

Many of the electrical features and systems in your boat are equipped with a control switch and protected with breakers or fuses. Switches are designed for different applications and found in many styles and shapes. Some switches may have a lighted indicator for easy ON/OFF identification.

Ignition Switch

The ignition switch controls the engine starter circuit, the engine ignition system and accessory circuits connected to the ignition switch.

Battery Switch

Battery switches are used to control battery power distribution and disconnect the batteries from the boat's electrical system. Battery switches are designed in many styles and for different applications. They generally provide battery isolation when used with multiple batteries and are used primarily as a method of quick and positive battery disconnection. Battery switches also protect against tampering, electrical fire hazards and battery drain. Keep this switch off when not using your boat or when storing it for extended periods of time. **NOTICE:** Do not move the battery switch with the engine running; this could damage the engine's charging system.

Consult a qualified, knowledgeable technician for proper operation of your boat's specific electrical system.

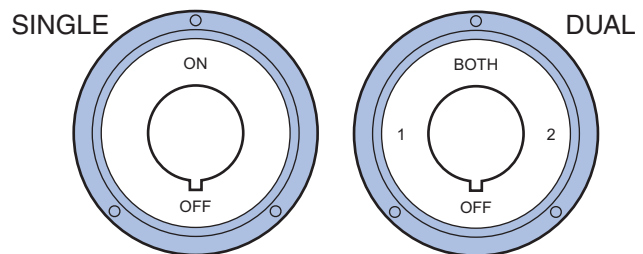

TYPICAL BATTERY SWITCH

KC-0292-A

Figure 9-23

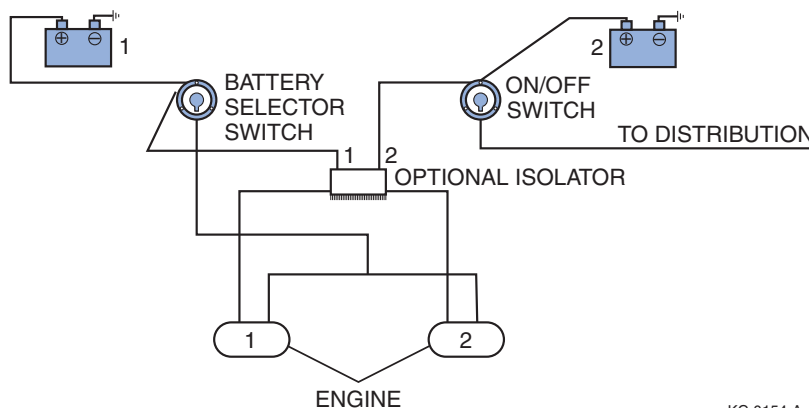

KC-0154-A

Figure 9-24



Boat Features and Options

Engine Emergency Stop Switch and Lanyard

The engine emergency stop switch controls the engine ignition ON/OFF. This safety device shuts the engine off immediately and prevents the boat from becoming a runaway if the operator is accidentally thrown from the seat or away from the helm.

Whenever your boat's engine is on, physically secure one end of the emergency engine stop switch lanyard to the emergency stop switch and the other to the boat operator. If the operator is thrown from the seat or moves too far from the helm, the lanyard will disconnect from the switch, activating the switch to turn off the engine.

- Never remove or modify the engine emergency stop switch and/or lanyard.
- Always keep the lanyard free from obstructions that could interfere with its operation.
- Always check the switch for proper operation. With the engine running, pull the lanyard. If the engine does not stop, have the switch repaired before operating your boat further.
- Never operate your boat if the engine emergency stop switch does not work.

WARNING! Removing the engine stop switch and/or the lanyard can cause loss of control. See Safety Precautions in the Safety Section of this manual for more details.

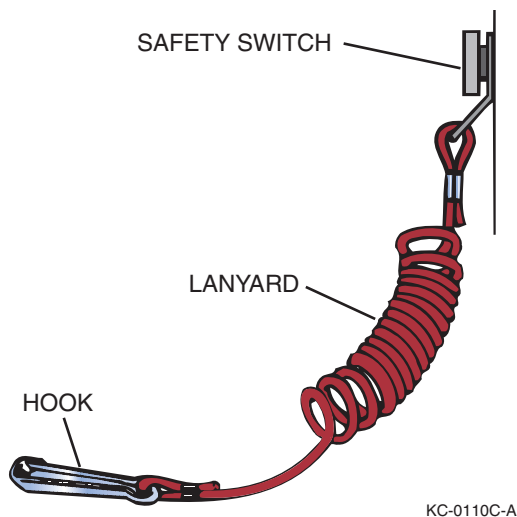

Figure 9-25

Neutral Start Safety Switch (Start-in-Gear Prevention)

The neutral start safety switch provides start-in-gear prevention. The switch controls power to the engine starter circuit of the ignition switch. The engine gear shift control lever must be in the NEUTRAL position to allow the ignition switch to activate the engine starter. This safety device will prevent the boat's engine from starting if the engine is in gear.

Horn Switch

The horn switch controls power ON/OFF to sound the horn.

Boarding and Courtesy Light Switches

The boarding and courtesy switches control power ON/OFF to boarding lights and cockpit courtesy lights.

Power Trim / Tilt Switch

The power trim/tilt switch controls power ON/OFF to the engine's power trim/tilt electric hydraulic pump. This switch is usually a three-position switch, with OFF in the center. If engine is equipped with power trim and tilt, this system allows you to raise and lower the lower drive unit and propeller to adjust trim (the planing, and running angle of the boat while under way).

The tilt feature positions the lower drive unit up beyond the power trim range and is used for trailering, launching or beaching. Never use power tilt when the engine is running.

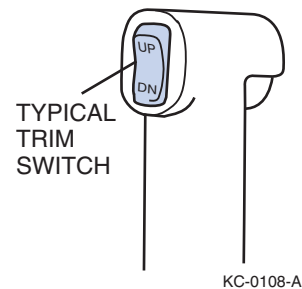

Figure 9-26



Section 9

Trim Tab Switches

The trim tab switches control power ON/OFF to the boat trim tabs' electric hydraulic pump. This switch is usually a three-position switch, with OFF in the center. Each trim tab has a separate switch, both switches can be used independently or simultaneously. Trim tabs adjust the boat's trim angle and help compensate for uneven weight distribution, listing, water conditions and other factors that contribute to planing inefficiency.

TYPICAL TRIM TAB SWITCH

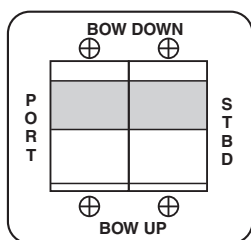

KC-0109-A

Figure 9-27

Navigation Lights Switch

The navigation lights switch controls power ON/OFF to the boat's navigation, running and anchor lights. This switch is usually a three-position switch, with OFF in the center. When the switch is in the NAV position, the red and green navigational, white stern and running lights, and console gauge lights are activated. When the switch is in the ANC position, only the white stern light is activated.

Never operate your boat between sunset and sunrise using only the stern light. Use all navigational lights when operating under way between sunset and sunrise.

Bilge Pump Switch

The bilge pump switch controls power ON/OFF to the bilge pump to remove excess water from the bilge area of the boat. Some models are equipped with an automatic bilge pump setting. Switching to AUTO when the boat is in operation will allow water to be automatically pumped out when it reaches a level that activates the float switch in the bilge area.

Be sure to switch the bilge to OFF (not AUTO) when your boat is not in use. Wave action or trailer travel can cause the pump to drain the battery. Running the pump when the bilge is dry will damage the pump. Do not allow the bilge pump to operate after all the water has been cleared from the bilge area; damage to the pump will occur if the pump is allowed to operate without water.

If oil is spilled in the bilge, do not run the pump. Keep the oil from spreading in the bilge and properly dispose of the oil on shore.

Fuel Gauge Switch

The fuel gauge controls power ON/OFF to the fuel gauge to allow use of the fuel gauge when the ignition switch is off.

Windshield Wiper Switch

The windshield wiper switch controls power ON/OFF to the windshield wipers.

BILGE PUMP SYSTEM

The Federal Water Pollution Control Act prohibits the discharge of oil or oily waste into the water. Violators can be fined \$5,000.

Water will enter a boat for a number of reasons, including heavy seas, strong storms and long periods of rain. The bilge area is usually the deepest part of the hull and where the water settles. The bilge pump moves water from the bilge area through hoses and empties it through an opening in the hull.

The bilge pump can be operated manually by a switch. Some models feature an automatic bilge pump setting. Switching to AUTO when operating your boat will allow water to be automatically pumped out when it reaches a level that activates the float switch in the bilge area. **NOTICE:** *Be sure to switch the bilge to OFF (not AUTO) when you are not using your boat. Wave action or trailer travel can cause the pump to drain the battery. DO NOT allow the bilge pump to operate after all the water has been cleared from the bilge area; damage to the pump will occur if you operate it without water.*



Boat Features and Options

BOAT VENTILATION SYSTEM

Boat ventilation systems allow the circulation of fresh air through compartments and enclosed areas of boats. The most common types of ventilation devices are manual or power-actuated vents, hatches, ports and windows that open and close. Ventilation ports are always located in head and galley compartments and are commonly found in cabins and sleeping areas.

FRESHWATER SYSTEM

A freshwater system provides potable (drinkable) water to sinks, showers, water heaters, ice makers and/or cockpit washdowns. Common freshwater systems are either manual or pressurized. Manual systems consist of a storage tank and hand pump/faucet. Pressurized systems may include a storage tank, electric pump, faucet, filter, accumulator, city water hookup connector, water heater, and showers, sinks or other appliances that require potable water. Regardless of the type of system, all freshwater drainage (gray water) is directed overboard and is usually untreated.

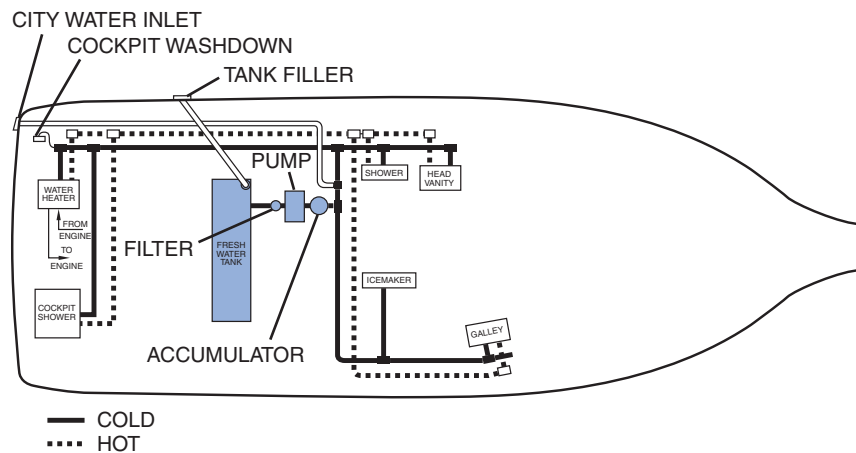

TYPICAL COMPLEX FRESHWATER SYSTEM

KC-0172-A

Figure 9-28



Section 9

Filter, Pump and Pressure Accumulator

Water flows from the tank through a filter to strain out any contaminants, and then flows to the pump. The pump provides a flow of water at a preset system pressure. Some pumps include a safety feature that will shut the pump off if it runs dry or when the tank is emptied. A pressure accumulator-style tank provides a smooth flow of water by maintaining a constant pressure in the lines to the various freshwater appliances.

Operation Guidelines:

- Fill the freshwater tank with potable water.
- Close all faucets and drains.
- Turn on the freshwater pump circuit breaker.
- Open each cold and hot water faucet to allow air to escape. Close the faucets when a steady flow of clean water is apparent.
- After all lines are empty, the pump will build to operating pressure and shut off.
- Refill the freshwater tank with potable water.

Freshwater Tank

Freshwater tanks are usually filled through a deck plate filler marked "WATER." A hull vent allows air to enter and escape the tank as the water level rises and falls. The tank is full when water comes out of the vent.

Fill the tank with only potable (drinking) water. The tank will continue to provide clean drinking water if you use and refill it often.

Guidelines when filling the tank:

- Remove the "WATER" filler cap with the key provided with your boat. Turn counterclockwise to remove the cap.
- Always use a sanitary drinking water hose (blue) when filling the tank with fresh drinking water.
- Replace the cap and fasten securely with the key.

TYPICAL DECK PLATE KEY

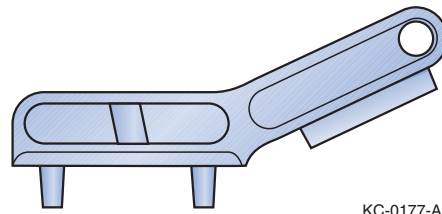

KC-0177-A

Figure 9-29

City Water Hookup

When docked, you can connect your boat's freshwater system to a city water system or shore pressurized system as an alternative to the on-board freshwater tank system.

Pressurized shore systems bypass the boat's freshwater tank and pump system, and connect directly into appliance lines. A pressure regulator limits the maximum pressure supplied to the system. *NOTICE: Always monitor your boat's water system during initial usage of the city water feature. In this mode, your boat is connected to an unlimited source of water. DO NOT leave your boat unattended while using city water. Any major leak or break in the system could cause sinking or swamping of your boat.*

Using the city water hookup does not replenish water supply in the tank. You can only fill the tank at the freshwater fill plate. Before connecting to any water fitting (dockside or otherwise), be sure the water is potable and suitable for human consumption. Also, a special sanitary drinking water hose is required for the potable water connection. Never use a common garden hose for drinking water.

Guidelines when connecting to city water:

- Turn off the freshwater pump breaker.
- Remove the threaded plug from the female swivel hose connector of the city water inlet fitting. Clean the strainer.
- Only connect a sanitary drinking water hose to the water inlet fitting.
- Be sure to clean both ends and flush the hose before connecting. Foreign matter may damage the pressure regulator.



Boat Features and Options

- Before connecting to the dockside city water outlet, open the valve fully to flush any rust particles that may be present.
- Connect the hose to the dockside city water outlet.

Hot Water Heater

Most water heaters are electrically heated and are equipped with a high-pressure relief valve and thermostat for safety.

Guidelines when operating the water heater:

- Fill the freshwater system or connect to city water and bleed air from all lines.
- Turn on the water heater circuit breaker.
NOTICE: DO NOT turn on the water heater circuit breaker switch unless the freshwater system is charged and the water heater is filled. Damage to the heating element will result if it heats up with no water in the system. Some water heaters are equipped with a high-temperature limit switch to protect the heating elements if the heater is activated with no water in the tank. If the system does not operate for any reason, turn off the water heater breaker and push the reset button on the heater.

RAW WATER SYSTEM

Raw water is seawater (non-drinking water). Some boats use raw water systems for engine cooling, head, and utility and cockpit washdowns. Some raw water systems may supply two components and have a flow control valve for directing water flow.

Raw water systems include:

- An individual thru-hull raw water intake.
- A seacock and strainer. The seacock protects your boat from sinking if a downstream hose or fitting would fail. Always close any seacock not in use.
- A pump to draw water into the system. Engines may have belt- or pulley-driven pumps; heads may have manual push/pull or electric pumps, and utility and cockpit washdowns may have electric pumps.
- An outlet valve, fitting or nozzle.

Guidelines when operating a raw water system:

- Open the desired seacock.
- Adjust flow control valve (if equipped).
- Turn on appropriate pump switch as required.



Section 9

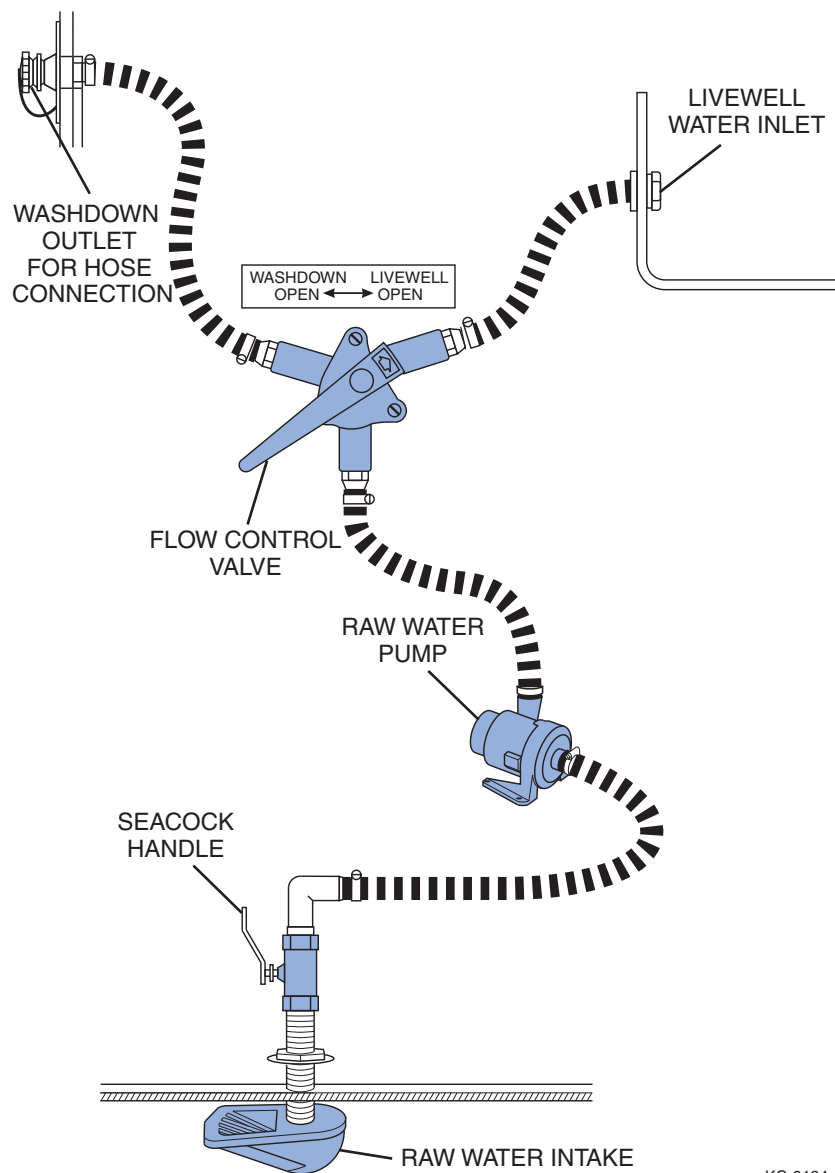

KC-0184-A

Figure 9-30

The following information may not apply to your air conditioning system. It is intended as basic air conditioning operating information. See the *Air Conditioning Operator's Manual* supplied with your air conditioner for specific information.

The most common marine air conditioning unit is the chilled water type. A typical chilled water air conditioner uses fresh water circulated through a closed loop fresh water line in the boat and an air conditioning unit to remove heat from the conditioned area. An air blower is used to move air over the fresh water line to assist in heat

transfer. The air conditioner unit is AC powered by either a shore power connection, or a generator, or both.

The fresh water in the line is circulated through an air conditioning evaporator coil where heat is transferred to the refrigerant in the evaporator coil, in turn cooling the water. Heated refrigerant gas is directed to the compressor, where it is compressed and then re-circulated through a condenser coil line.



Boat Features and Options

Raw water (seawater) is pumped from a seacock through a strainer into an inner tube inside the condenser coil line. Heat is transferred from the refrigerant to the raw water and pumped overboard removing the original heated cabin air.

This cycle repeats, as cooled fresh water (not seawater) is pumped back through the lines in a continuous loop.

Note: Condensation can occur due to the temperature difference between the refrigerant, raw cooling water and air around the cooling coils. Water from condensation is typically collected in a sump tank or is drained overboard, depending on the installation. Periodic cleaning of the sump tank or drain will prevent the buildup of debris that can lead to foul odors, or cause slow drainage.

A typical air conditioning system uses an air conditioning control panel to display system information and control the operation of the air conditioning system. A control panel for each unit (if equipped with multiple units) is located centrally, relative to the conditioned area. **LIVEWELLS**

Livewells are designed to help protect and keep fish or bait alive. Some are equipped with an aeration pump that circulates and refills the water in the livewell to help keep fish alive.

Always clean and empty the livewells after each use to prevent contaminating the fish. Never use soap, detergents or other cleaners that may be harmful to fish to clean the livewell.

If a livewell system does not drain completely, you may have to bail remaining water by hand or remove your boat from the water. *NOTICE: To avoid freeze damage to the livewell system, be sure it is completely empty in freezing weather. Residual water in the system may freeze and cause damage.*

Livewell systems are usually manual, remote or recirculating. Do not use manual and remote livewell systems while your boat is in operation or on the trailer. Also, make sure the livewell pump is switched off, or pump damage will occur.

Manual Livewell

Manual livewells aerate the water by continuously pumping sea/lake water into the well. A spray-head nozzle aerates the water by spraying water into many small streams that splash into the livewell water.

To fill the livewell, install the removable overflow tube (or drain plug if equipped with an overflow fitting) into the drain hole, and turn on the livewell pump. The water level will maintain the height of the overflow.

To empty the livewell, turn off the livewell pump and remove the overflow tube (or drain plug).

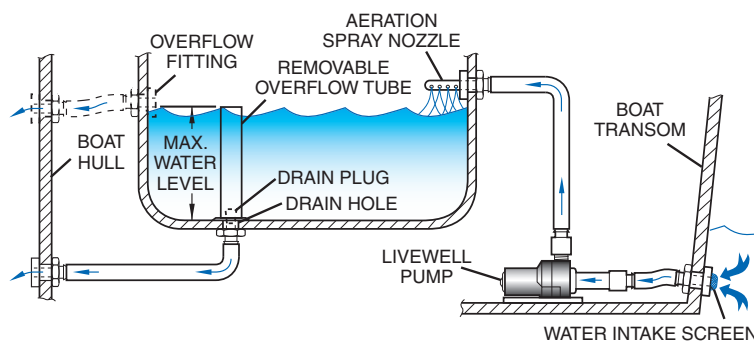

Figure 9-31



Section 9

Recirculating Livewell

Recirculating livewells allow water recirculation while a boat is in operation or on the trailer. Like manual and remote types, this system continuously aerates the livewell with sea/lake water while you are fishing. While under way or

when trailering, the system can be closed to recirculate the water in the livewell. During recirculation, keep in mind that sea/lake water is not used and water temperature increases quickly, which may kill the fish in the livewell.

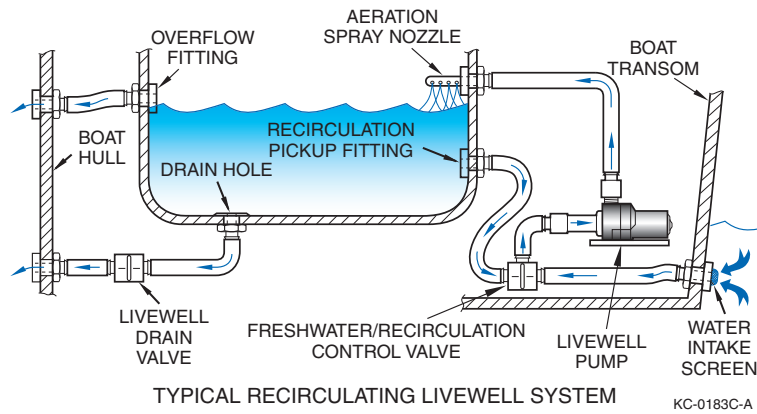

Figure 9-32

Remote Livewell

Remote livewells operate similarly to manual livewells; the primary difference is the addition of a remote-controlled livewell drain. The drain valve control is usually located near the helm or the livewell.

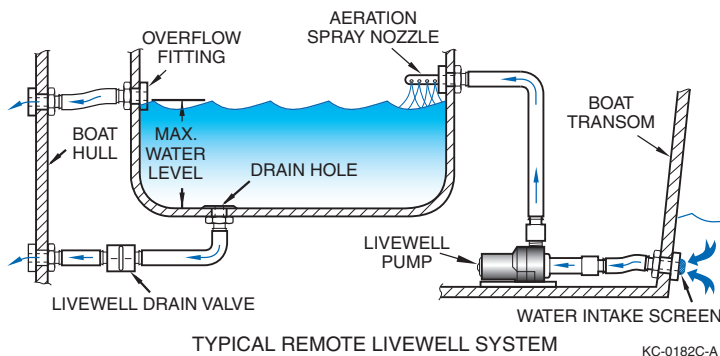

Figure 9-33



Boat Features and Options

Livewell Controls and Operation

Livewell Pump Switch

The livewell pump switch controls the livewell pump ON/OFF. Some models may have an automatic setting for use in conjunction with the livewell timer to vary the on/off time cycle. On models with an automatic setting and no timer, the time cycle is approximately one minute on and three minutes off. *NOTICE: Most livewell systems draw power from the main engine cranking battery. The automatic setting, if available, will help conserve battery power.*

Livewell Timer

A livewell timer can continuously vary the OFF time interval. Pump ON interval will remain at approximately one minute regardless of the OFF time setting. On models with two livewells, this timer may be wired to control both livewell pumps.

Livewell Control Valve

A livewell timer can continuously vary the OFF time interval. Pump ON interval will remain at approximately one minute regardless of the OFF time setting. On models with two livewells, this timer may be wired to control both livewell pumps.

Livewell Drain Switch

The livewell drain switch turns the livewell drain pump (if equipped) ON/OFF. Be sure to turn the pump off when it is not in use.

HEAD AND WASTE CONTAINMENT SYSTEM

Always check state and local regulations before discharging waste overboard.

Head (marine toilet) and waste containment systems are available as manual or electrically-operated systems. Electrically operated systems use electric raw water pumps to flush waste from the marine toilet into the boat's waste tank. A waste tank indicator may be installed to provide a visual indication of the amount of waste in the tank.

All boats with heads are required to have a USCG-approved operable marine sanitation device installed. These devices, commonly called macerators or chlorinators, are used to break up solid and chemically treated waste and discharge it into waste tanks or overboard.

Waste Removal System Types

- *Dockside Discharge* – Waste tanks are emptied through a deck plate fitting marked “WASTE” by special waste removal equipment on the shore.
- *Overboard Discharge* – Waste tanks are emptied through the hull into the sea/lake. A “Y” valve is used to change discharge flow between the marine toilet and the waste holding tank.

Components of waste systems are constructed of materials specially formulated to prevent odor permeation and resist chemical actions. Regularly add approved waste treatment chemicals to your tank by flushing them through the head. The chemicals help to control odor and break down the waste. Follow chemical manufacturer's instructions before use.



Section 9

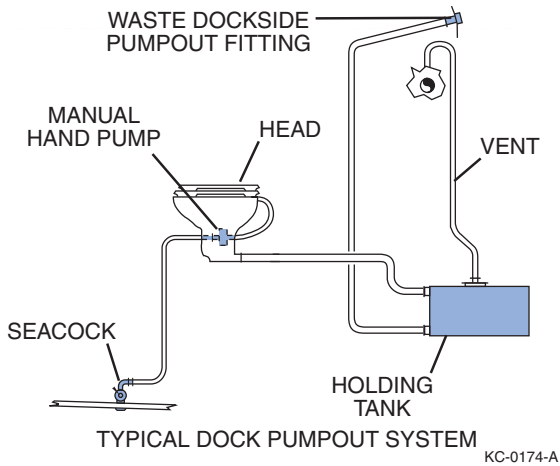

Figure 9-34

Head Operation

See the marine head manufacturer's information for specific information. **NOTICE: DO NOT flush the head when the holding tank is full. Attempting to flush the head when the waste tank is full could result in damage to the waste system.**

Guidelines for Electrically Operated Marine Heads:

- Open the raw water seacock to the head.
- If you are using overboard discharge, make sure the "Y" valve is in the overboard position and that the macerator discharge seacock is open.
- To charge the head, press the foot pedal on the lower left side of the bowl and push the flush button. Release the flush button after the bowl is moistened. Then pump the floor pedal two to four times to fill the bowl with water.
- To flush, press the foot pedal and push the flush button at the same time. Hold until all waste is removed.
- To empty the bowl of excess water, operate the flush button until water decreases to the desired level.

Guidelines for Manually Operated Marine Heads:

- Open the inlet water seacock below the cabin floor.
- If you are using overboard discharge, make sure the "Y" valve is in the overboard position and that the macerator discharge seacock is open.

- Pump the floor pedal two to four times to fill the bowl with water.
- To flush, press the foot pedal and operate the flush handle next to the head at the same time. Operate the handle until all waste is removed.
- To empty the bowl of excess water, operate the flush button until water decreases to the desired level.

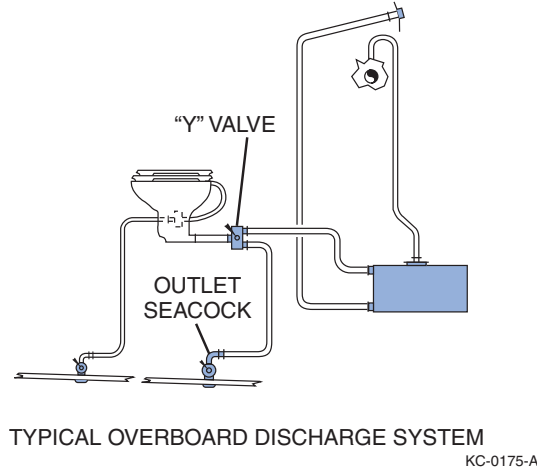

Figure 9-35

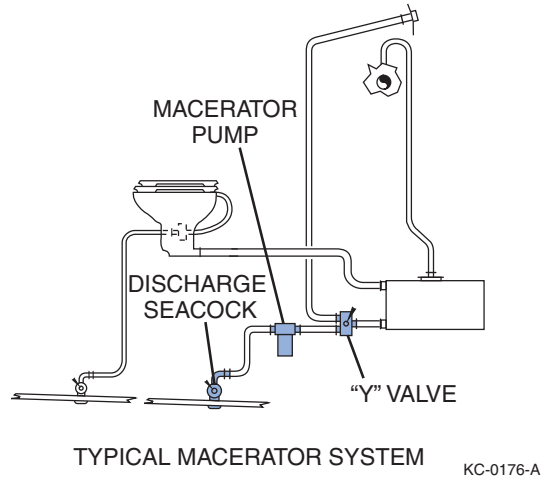

Figure 9-36



Section 10

GENERAL CARE AND MAINTENANCE

Your boat may feature a variety of specialized systems and components. The following basic and typical information may not apply to your specific application. This section may not cover all systems or components on your boat. See the *Engine Operator's Manual* or the equipment manufacturer's information for maintenance procedures.

Maintenance procedures may require special knowledge and equipment. Always consult your local marine dealer or certified marine technician for assistance in performing service, maintenance or modifications to your boat.

Neglect of maintenance and unauthorized service work is not recommended and may void your warranty. Refer to the Engine and Equipment Manufacturer's maintenance schedules and requirements, and keep a detailed log of the procedures and dates completed. Always consult your local marine dealer for assistance with periodic maintenance.

Before performing any general care and maintenance procedures within this section, see *Safety on page 2-1*.

ENGINE

The manufacturer of your boat's engine(s) will provide a separate maintenance procedure. See the *Engine Operator's Manual* for specific information on maintenance procedures.

FUEL SYSTEM

Fuel vents are normally located in the deck in the same general area as the fuel fills. Periodically check that the fuel fills and vent lines are free of obstructions and kinks.

Check and/or replace the fuel filter periodically or clean as needed. Check fuel lines, vent hoses and drain hoses frequently for leaks. Replace any worn or cracked hoses.

Tightening a fitting or clamp may correct a fuel leak. If the leak continues, however, replace the line, fitting or hose immediately to prevent a build-up of fluids or gases.

Use fuel system parts certified for marine use only. Never use automotive parts in marine applications.

ELECTRICAL SYSTEM

Before performing any work on the electrical system or the battery, see *Safety on page 2-1*.

Battery

Always turn off the battery switch (if equipped) or disconnect the negative battery cable before servicing the electrical system.

When you install a battery:

- Always use correct polarity when you connect the battery cables to the battery.
- Make sure the battery terminals are clean.
- Make sure the cable connections are tight.
- Always shut down the engine before removing or attaching battery cables and never run the engine with the battery cables disconnected.
- Always remove the negative (-) cable first. Always attach the negative (-) cable last.



Section 10

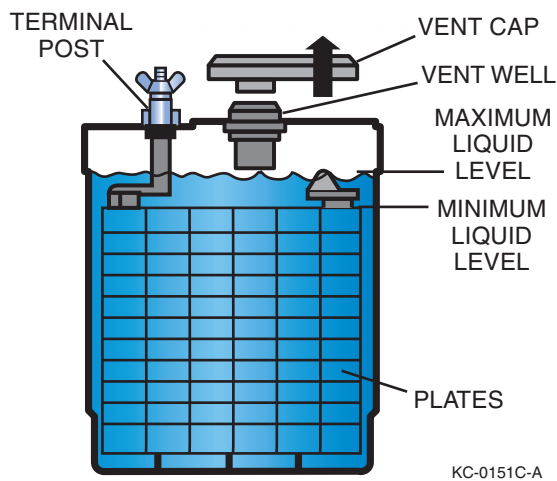

Figure 10-1

Check the battery frequently for signs of corrosion. If corrosion is evident, clean the terminal posts with a baking soda and water solution and a wire brush. Disconnect the battery terminals before cleaning.

Check the fluid levels in the cells. **NOTICE:** *Some batteries are sealed and cannot be filled.* A level of approximately 1/4 to 1/2 in. (6 to 13 mm) above the plates is sufficient. If needed, fill with distilled water; do not overfill. **WARNING! Lead-acid battery fluid can cause severe burns.**

During extended periods of non-use, batteries will self-discharge and should be recharged. Before recharging, disconnect the battery terminals and remove the battery from your boat. Recharge the battery according to the directions enclosed with your battery and battery charger. When installing the battery in your boat, make sure the battery is secured in the battery box, the terminals are tight and all protective covers are in place. **WARNING! Hydrogen gases produced by a lead-acid battery while it is charging, or the engine is running, can cause an explosion and/or a fire.**

Circuit Breakers and Fuses

Never exceed the recommended fuse sizes or bypass a fuse in a circuit. Always install the proper (type and rating) fuses whenever replacing or changing fuses. Continuous fuse/breaker failures indicate a severe problem and require immediate attention. **WARNING! Installing an incorrect fuse or breaker can cause a fire.**

Some applications use circuit breaker switches to provide individual circuit protection with the ability to manually reset the breaker switch.

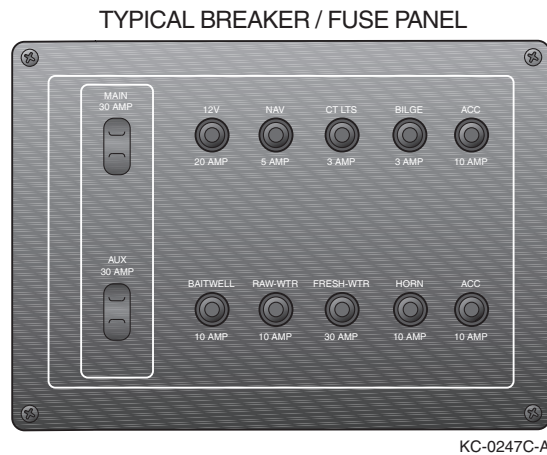

Figure 10-2

To reset a tripped circuit breaker, move the breaker switch to OFF. Identify and correct any problems with the circuit and unplug all loads connected to it. Wait a minimum of one minute for the breaker switch to cool and then push the breaker switch to ON. Turn the breaker switch to OFF immediately if it trips, and consult qualified personnel.

To replace a fuse, locate the fuse block and the failed fuse. Carefully remove the fuse without touching other fuses or wires. When possible, use a fuse removal/installation tool. **WARNING! Never reset a breaker that has been automatically tripped, or replace a burned out fuse, without first identifying and correcting the cause of the problem. A fire could result.** **NOTICE:** *A boat's electrical system is designed to protect you from electrocution, short circuits and overloads. Have a qualified electrician perform any modifications to the system such as adding electrical accessories. Some installed accessories, such as stereos, have an additional fuse located in-line with the positive lead. Other accessories may use in-line fuses near the battery.*



General Care and Maintenance

STEERING SYSTEM

Inspect and maintain your boat's steering system regularly. Frequently check the hardware at the helm, engine or rudder end for tightness. See the *Engine Operator's Manual* or the steering manufacturer's information for the appropriate torques.

Make sure hydraulic hoses are tight and leak-free. Check cylinder seals for dampness, which indicates leaking. Check the fluid reservoir monthly and top off if necessary. See the steering system manufacturer's information for more details.

TYPICAL HYDRAULIC STEERING SYSTEM

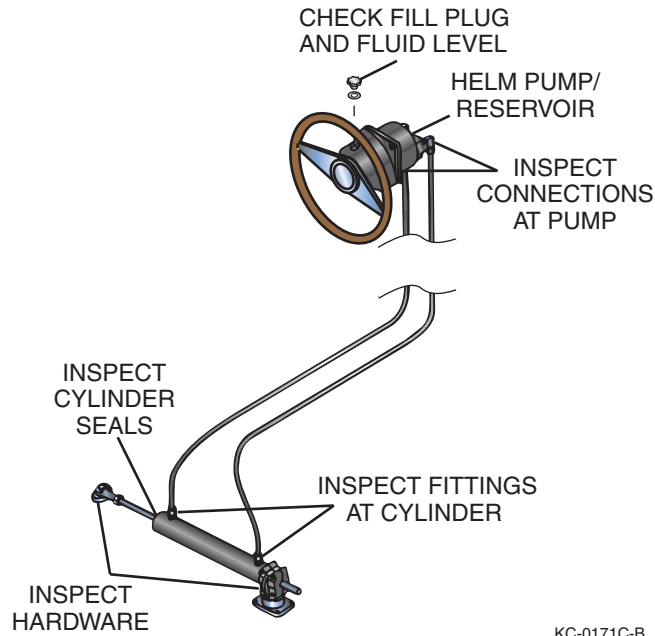

KC-0171C-B

Figure 10-3

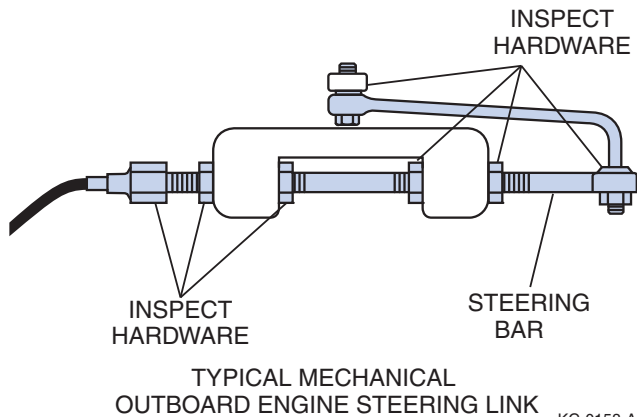

KC-0158-A

Figure 10-4



CORROSION PROTECTION

Hardware, Fasteners and Fittings

Check all fasteners, fittings, hinges, latches, rails and cleats for corrosion and tightness. Repair or replace any items that need attention. Never use automotive replacement parts when replacing marine parts.

Periodically clean all hardware with approved marine cleaners or mild soap and water. Never use abrasive cleaners or materials; they will scratch the polish and protective coatings on the hardware and cause the hardware to corrode. Applying a coating of marine-grade wax can help maintain the original shine of the hardware and help prevent corrosion.

Stainless Steel and Chrome Hardware

Stainless steel and chrome will normally oxidize over time, especially in marine environments. Cleaning and preventive maintenance of stainless steel and chrome hardware are crucial in maintaining appearance and functionality. If the hardware is left unattended, it can corrode, causing the hardware to appear unsightly and cause structural integrity problems.

Wash the stainless steel and chrome hardware with mild soap and water after operating your boat in corrosive environments such as salt water.

Remove rust or corrosion promptly by cleaning the hardware using a high-quality stainless steel, chrome cleaner or conditioner. Do not use any abrasive materials such as steel wool or sandpaper to clean the hardware. Do not use acids or bleach or any cleaners not intended for stainless steel or chrome, such as glass, tile or counter cleaners, as these types of cleaners can cause permanent damage. Always test a cleaner in an inconspicuous area first before applying to the complete surface.

After cleaning, protect the surface of the hardware by using a high-quality boat, automotive, stainless steel or chrome protectant or wax.

Aluminum Hardware

Periodically wash aluminum hardware with soap and water to keep it clean. If your boat is used in salt water or polluted water, wash aluminum hardware with soap and water after each use. Salt water allowed to remain on aluminum will penetrate the metal and corrode the aluminum.

It is recommended to frequently clean and coat all aluminum hardware with a metal protectant made for aluminum to protect against pitting and corrosion caused by the harsh effects of salt water. Choose an appropriate cleaner specific to your needs, as special cleaners are available for different types of aluminum hardware such as anodized, powder coated and polished.

Most stains can be removed from aluminum with a metal polish or fine polishing compound. To minimize corrosion, use a caulking compound or Teflon-based sealer to isolate hardware and fasteners mounted to aluminum fabrications. With proper care, aluminum hardware can provide many years of service.

Galvanic Corrosion

Galvanic corrosion (electrolysis) is the deterioration of metals from the effects of electrolytic action. When two dissimilar metals are immersed in a conductive fluid such as salt water, an electric current is produced, much like a battery. As current flows between the two metals, the softer, or sacrificial, metal deteriorates.

If you operate in salt, polluted or brackish waters, your boat should be equipped with a transom-mounted sacrificial anode to prevent corrosion damage to other metal parts of your boat that are in contact with the water. The anodes are self-sacrificing and are slowly eroded by electrolytic action. These anodes are important and require periodic inspection for deterioration. Replace the anode when less than 50% of its original size.



General Care and Maintenance

Most engines are equipped with one or more anodes that require periodic inspection. See the *Engine Operator's Manual* for maintenance procedures.

Electronic cathode systems are designed to reduce the effects of electrolysis. Electronic cathode systems emit an electrical low-current charge into the water near the metal components' neutralizing electrolytic action. **NOTICE: Do not paint or coat sacrificial anodes or cathodes with any substance. Once covered, they do not provide protection from galvanic corrosion. Replace anodes if they have deteriorated 50% or more.**

Salt Water Corrosion

Rinse your boat hull and deck with fresh water and wash immediately after using your boat in salt water. If your boat is used primarily in salt water, wax the hull monthly and apply corrosion inhibitor to all hardware. See the *Engine Operator's Manual* for the flushing procedure.

Flushing the freshwater engine cooling system is recommended when the engine has been used in salt, polluted or brackish waters. Flush the entire engine cooling system with fresh water for at least 5 minutes after use in these waters. Consult your local marine dealer for suitable flushing equipment.

GENERAL MAINTENANCE AND CLEANING

Marine Growth

If accelerated marine growth is a problem in your area, an antifouling bottom paint may be necessary to slow growth and prevent gelcoat damage. Before selecting a bottom paint, talk with other boaters and your local marine dealer to determine which product works best in your area. Many local variables can affect the selection of paint. Be sure to follow the paint manufacturer's directions exactly.

Cleaning

Never allow any type of cleaning solution or cleaning material to come in contact with the water or be discharged into the water. The

discharge of any type of debris or waste, including, but not limited to, food, trash, garbage, oil, fuel, liquids and human waste, is highly restricted, if not unlawful, in most waterways. Never discharge anything into the water.

Periodic cleaning is the best way to keep your boat looking new. Regular washing and waxing keep dirt, algae and water deposits from building up and deteriorating the finish. Keeping your boat in "show room" condition means greater personal satisfaction and higher resale value. Special cleaning products are available from your local marine dealer.

Hull

When washing your boat, use a mild detergent with a warm water solution. Never use abrasive cleaners, solvents, ammonia or chlorine to clean gelcoat surfaces, as these will damage the gelcoat surface. Special cleaners are available from your local marine dealer to remove marine growth and algae from the hull.

Wax gelcoat surfaces at least twice a season. Special marine gelcoat waxes are available from your local marine dealer to prevent color fade and dirt adhesion. If the gelcoat has oxidized, chalked, dulled or faded from lack of proper maintenance, buffing may be necessary to bring back the shiny appearance. Hand buffing with #7 rubbing compound or power buffing with glazing compound #1 will quickly restore the surface; however, always seek certified assistance before attempting to restore your boat's finish.

Upholstery

Regular washing with mild detergent and warm water or non-solvent type automotive vinyl cleaner is sufficient to keep the cushions, canopy top and other vinyl coverings in good condition. Keep the cushions from becoming soaked and dry off thoroughly after washing to prevent mildew accumulation after your boat is covered. Position the cushions up in your boat when covered to allow air circulation and spray with mildew repellent.

For tough stains on vinyl such as adhesive and rust, use a citrus cleaner followed by a mild detergent and warm water. For ink stains, apply



Section 10

denatured alcohol and wipe off. Note that some products such as suntan lotion, shoe polish and wet leaves may stain permanently.

Although not always convenient, minimizing your boat's contact with damaging ultraviolet (UV) rays and storing removable seats and canopies indoors when not in use will increase the longevity of vinyl upholstery. **NOTICE:** *Certain automotive, household and industrial cleaners can cause further damage and discoloration. Be cautious when using solvents and dry-cleaning fluids, or products that contain dyes such as waxes. Whenever cleaning stubborn stains, test the treatment in an unseen area first. Use the following stain treatments with discretion. Between steps, be sure to rinse thoroughly with plenty of clean water and allow to dry.*

Canvas Covers and Bimini Tops

In most cases, boat canvas receives more abuse than any other item on a boat. Canvas must be regularly maintained for long life and top performance. Moisture, dirt and chemicals from industrial fallout, heat, ultraviolet rays and salt water can all contribute to the deterioration of canvas. These elements can cause serious damage if left unchecked. The following guidelines will help you keep your canvas in good condition for years to come:

- Convertible tops are not designed for extended exposure to the elements as a protective cover at dockside or when your boat is in storage. Use a full, properly fitted, light-colored mooring cover for these purposes.
- If canvas gets wet during use, remove any side curtains and open the windshield to allow both sides and all seams to dry. The air circulation will allow all canvas to dry and prevent the growth of mildew. Never store wet or damp canvas.
- Occasionally set up all canvas and curtains, and hose down with fresh water to remove accumulated soot and dirt. Sweep or brush the underside of the canvas to prevent the accumulation of dirt and mildew.

- Wet canvas must be allowed to dry thoroughly before storage. Never allow canvas to dry loose since shrinkage can occur. Install and stretch all canvas fully on your boat when drying.
- Never allow the canvas to be exposed to direct sunlight for long periods of time.
- Use care when handling clear vinyl curtains and windows to prevent scratching. Never use cleaners on clear vinyl curtains and windows. Use clean water and a soft, clean cloth.
- Never fold canvas where creases can form in the material. Loosely roll canvas to prevent damage.
- Never store canvas in plastic bags. Store canvas in a dry, well-ventilated compartment.
- Outer canvas surfaces can be cleaned with a soft scrub brush and either automotive convertible top cleaners or household cleaners suitable for use on vinyl surfaces. The underside of the canvas may be periodically sprayed with a spray disinfectant to prevent mildew.
- Never store or dock your boat under trees. Tree sap is very corrosive to canvas and can also be harmful to gelcoat and vinyl interiors.
- Adjust canvas top bows to eliminate pockets in which rainwater can accumulate. The weight of accumulated water can collapse or damage the canvas top.
- Lubricate snaps and zippers regularly. Vaseline, silicone spray or paraffin are effective lubricants. Never force snaps and zippers that are stuck.
- Never trailer your boat with the convertible top in the mounted position. Dismantle, roll and securely store all canvas while trailering your boat to prevent wind damage.

Carpet

Occasional vacuuming and washing with mild detergent and warm water or household carpet cleaners will keep the carpet clean. Thoroughly wash the detergent out of the carpet with clean water. Let the carpet dry in the sun to prevent any mildew or odor caused by moisture.



General Care and Maintenance

Windshield

A clean windshield is important. If your boat is equipped with a glass windshield, applying a nonabrasive glass cleaner with a soft cloth will remove most dirt. Clean tinted Plexiglas or plastic windshields with a mild soap solution and damp cloth only. Harsh detergents, solvents, chemicals or dry cloths used on any glass or plastic windshield will scratch the surface.

Window Channels

Nylon pile is typically used in sliding window channels. Never use any products that contain bleaching solutions to clean window channels or seals. Use only a mild detergent and water solution for cleaning. If windows stick, spray the channels with silicone spray while working the window back and forth.

Teak

Teak is an organic and porous wood that contains natural oils and silicates that make it ideal for marine applications.

Depending on the interior or exterior application of the teak used on your boat, different cleaning and refinishing procedures may be required. The following information is intended as a guide.

Always consult with your boat and teak manufacturer before performing any cleaning or refinishing procedures.

Cleaning

Only use approved teak cleaners and follow the manufacturer's instructions and warnings carefully. The use of unapproved teak cleaners, such as general or all-purpose cleaners, rust removers or cleaners containing acid, will damage the teak and/or fasteners and the caulking used to secure the teak.

When cleaning areas that have caulking in the seams between teak boards, use special care to prevent damaging or removing the caulking. Do not use cleaners containing chlorine.

When cleaning, always scrub across the grain using a Scotch-Brite™ type scrubbing pad or plastic bristle brush. Scrubbing with the grain may

cause damage by removing soft grains from the teak. On larger areas, rotary scrubbers can be used.

Refinishing

Lightly sand all teak surfaces periodically to smoothen the exposed surfaces. This exposes less wood grain area to the elements and helps prevent the exposed grains from trapping dirt.

When sanding teak, the grit of the sandpaper and sanding method used depend on the condition of the teak. Minor scratches may be repaired using sandpaper (400 to 1000 grit). Major scratches and refinishing may require a sanding machine and the use of lower grit sandpaper. When sanding, always hold the sandpaper or pad flat on the teak to avoid gouging the teak.

To repair chips, cracks, plugs or breaks, special epoxies are available specifically for use with teak. When replacing caulking, take care to keep the seams dry and clean. Always use caulking approved for teak use and follow the manufacturer's instructions and warnings carefully. Immediately repair damaged areas or areas that always appear wet, as water leaking between seams or under the decking can cause further damage.

Sealants and Oils

The use of sealants or surface finishes on exterior applications is generally not recommended and should only be applied after consulting with your boat and teak manufacturer. Never use sealants containing kerosene or petroleum products.

As teak is a porous material that contains natural oils and silicates, the use of protective oils or sealants is not recommended for exterior and most interior applications. Applying oil to teak can cause personal safety hazards, permanent teak damage and increased maintenance, and can shorten the life of the teak. In addition, teak oils can be harmful to other materials such as caulk, vinyl, plastics, gelcoats, etc.



Section 10

Bilge

A boat's bilge area accumulates oil and greasy dirt over a period of time and should be cleaned periodically. Consult your local marine dealer for recommendations on special bilge cleaning products and procedures.

Bilge Pump

Periodically check the bilge pump(s) inlet screens and hoses for obstructions and debris. Foreign materials can clog the screen and hoses or become lodged in the bilge pump impeller, which can cause the pump to malfunction. Periodically check the operation of the bilge pump and float switch, if equipped. Inspect all wiring, clamps and hoses for tightness on a regular basis.

Detectors

Inspect fire, gas vapor and CO detectors periodically for proper operation. See the manufacturer's information for periodic testing procedures.

Trim Tabs

Periodically inspect the trim tabs for damage and leaks. Check the hydraulic pump fluid level periodically and fill with the recommended fluid.

FRESHWATER SYSTEM

Perform the following maintenance monthly to help keep the freshwater system clean and sanitary.

- Drain the freshwater tank completely using all faucets, showers, etc. Refill tank with at least 20 gallons of clean, fresh water and drain again.
- Clean freshwater pump inlet filter screen, if equipped.
- Replace freshwater system filter(s), if equipped.
- Clean city water inlet strainer, if equipped.
- Flush city water system using all faucets and showers.

If water in the tank has stagnated and you suspect that the freshwater system may be contaminated, sanitize the system.

To sanitize:

- Drain the freshwater tank completely using all faucets and showers.
- Mix a solution of 1/4 cup household bleach to one gallon of water for every 15 gallons of tank capacity. Pour the solution into the freshwater tank.
- Fill the tank with clean, fresh water.
- Turn freshwater pump on and bleed air from all faucets, showers, etc.
- After approximately three hours, drain the system completely.
- Flush the system with one full tank of water.
- Fill tank with clean, fresh drinking water.

If you can smell or taste bleach in the water:

- Drain the system completely.
- Mix a solution of one quart of white vinegar to five gallons of water. Pour the solution into the freshwater tank.
- Allow the solution to remain in the tank until you have logged approximately one hour of cruising time. Boat motion will move the vinegar/water solution around to help clean the tank.
- Allow the solution to remain in the tank for at least one week.
- Drain the freshwater system completely.
- Flush the system with one full tank of water.
- Fill the tank with clean, fresh drinking water.

RAW WATER SYSTEM

Periodic maintenance guidelines:

- Lubricate and operate all seacocks, checking for proper operation.
- Inspect, clean or replace strainers as necessary.
- Check for leakage at all hull fittings, lines, connections, valves, etc.
- Check all raw water-related pumps, controls and appliances for proper operation.
- Clean and flush all lines and systems with clean, fresh water and approved cleaners.



General Care and Maintenance

HEAD AND WASTE CONTAINMENT SYSTEM

Head (Marine Toilet)

Periodic maintenance guidelines:

- Use a non-abrasive cleaner for the bowl.
- A light coating of a general-purpose marine lubricant on the pump rods and slides will reduce friction of moving parts.
- Use recommended deodorant and lubricant for the internal parts of the head.
- Always flush the head completely to clear any waste from the bowl and/or lines to the waste tank. This can prevent odor and waste buildup in the lines. To reduce odors, pour and keep some fresh water in the bowl after flushing.

Waste Holding Tank

If your boat has an optional waste holding tank installed, various chemicals are available to control odors and help break down solids. Consult your local marine dealer for product suggestions. After the holding tank is emptied, fill the tank with fresh water and pump it out again to rinse. *NOTICE: The discharge of any type of debris or waste, including, but not limited to, food, trash, garbage, oil, fuel, liquids and human waste, is highly restricted, if not unlawful, in most waterways. Never discharge anything into the water.*

SAFETY EQUIPMENT

Periodically check the safety equipment for damage, general condition and operation when applicable. Always replace safety equipment that is in question or in need of repair:

- Fire extinguisher
- Life jackets
- Visual distress signaling devices
- Audible distress signaling devices
- Navigational lights
- Emergency radios or Emergency Position Indicating Radio Beacon (EPIRB)
- First aid kit

GENERAL BOATING EQUIPMENT

Periodically check the general equipment on-board for damage, general condition and operation when applicable. Always replace equipment that is in question or in need of repair.

- Anchors and anchor lines
- Boat hook
- Dock fenders
- Foul weather gear/clothing
- Mooring lines
- Oars/paddles
- Tool kit
- Tow line

TRAILER

Periodically check the general trailer components for damage, general condition and operation when applicable. Always replace trailer components that are in question or in need of repair.

- Lights
- Electrical connectors
- Tires (condition and pressure)
- Wheel lug nuts and studs
- Wheel valve stems
- Wheel bearings
- License plate and holder
- Rollers, bunks and hardware
- General fasteners (missing, loose or corroded)
- Safety chains or straps
- Winch, winch strap and hooks
- Trailer coupler and latch
- Frame, axle and springs
- Spare tire and wheel
- Brakes and actuator assembly



Section 10

This Page Intentionally Left Blank



Section 11

WINTERIZATION AND STORAGE

Your boat may be equipped with a variety of specialized systems and components. The following basic and typical information may not apply to your specific application. This section may not cover all systems or components on your boat. Consult your local marina or certified marine technician for assistance.

Winterizing or storing your boat for extended periods of non-use requires special preparation to prevent boat and system damage. Without proper preparation, if your boat is not used or is stored for extended periods of time, internal parts of the engine may become corroded from lack of lubrication. If your boat is stored in freezing temperatures, water inside the bilge, engine cooling system or boat water systems may freeze and cause damage. Be sure to keep up with all annual maintenance during winterization.

Before performing any winterization and storage procedures within this section, see *Safety on page 2-1*.

WINTERIZATION AND STORAGE PREPARATION

The following procedures will help prevent damage to your boat:

- While your boat is still in the water, fill fuel tank(s) with fresh fuel and add the proper amount of fuel stabilizer/conditioner according to the engine manufacturer's recommendations. Operate your boat for at least 15 minutes to be sure that the treated fuel has reached the engine. **NOTICE:** *If you plan to store your boat for more than three months in either a humid environment, extreme temperatures or outdoors, "fog" the engine with a corrosion-preventing fogging oil according to the propulsion system manufacturer's recommendations. See the Engine Operator's Manual for more information.*

- Once your boat is removed from the water, remove the bilge drain plug immediately. Store the drain plug in a plastic bag and tape it to the throttle control lever for easy accessibility the next time you use your boat.
- Inspect all sacrificial corrosion protection anodes for excessive wear and replace as necessary.
- Check all thru-hull fittings and other fasteners for tightness and leakage.
- Thoroughly clean the hull, deck and interior of your boat as soon as you remove it from the water; marine growth is easier to remove when it is wet.
- Always allow all boat compartments to air dry for a couple of days to prevent mildew from trapped moisture. If you use shrink wrap, always allow for ventilation to prevent mildew from trapped moisture.
- Apply a coat of wax to the entire surface of your boat and rust inhibitor on all metal parts.
- Clean all traces of dirt, oil, grime and grease from the engine and bilge.
- After washing, raise the bow of your boat high to allow as much water as possible to drain while performing other storage preparations.
- Touch up areas where paint has been removed.
- Prepare the engine for storage according to the *Engine Operator's Manual*. Flush the engine cooling system with clean water and/or a nontoxic antifreeze mixture approved for marine use. Never exceed the maximum engine rpm for flushing recommended as stated in the manual.
- Perform all scheduled maintenance for the engine and boat equipment. See the *Engine Operator's Manual* and all equipment manufacturer's information for periodic and annual maintenance procedures.
- Turn off all electrical switches and breakers.



Section 11

- Remove all batteries from your boat. Clean, fully charge and store the batteries in an area outside your boat not subject to freezing temperatures. Never store batteries close to heat, sparks or open flames.
- Open all water faucets, drains and seacocks, and thoroughly drain all tanks and water lines. Use the freshwater pump to empty all the water from the freshwater storage tank and intake lines. Manually disconnect any lines that may have residual water trapped.
- Empty all water from the water heater.
- Empty and clean the waste containment system and flush with fresh water.
- Use nontoxic antifreeze approved for marine use to prevent freeze damage in the freshwater, raw water and waste systems. Consult your local marina or certified marine technician for recommendations for your system.
- Clean all interior upholstery, furniture, appliances, etc.
- Pest/rodent repellents may help prevent damage to your boat during storage.

STORING ON A CRADLE OR BLOCKS

- When storing a boat on support other than the proper trailer, make sure the hull is supported properly to prevent hull damage. Most cradles are custom-built to support the boat's hull.
- Put the cradle or blocks on a hard, level surface capable of supporting the combined weight of the cradle and your boat.
- When using blocks with jack stands, always use jack stands that are rated for more than the required load, making sure they are securely positioned so they cannot move under the load. Use a minimum of three blocks to support the keel and each side of your boat where applicable. Use a minimum total of nine jacks and/or blocks.
- Position your boat to allow for adequate draining from rain or snow.
- Cover your boat to prevent the collection of rain, snow or debris. When using a cover, allow ventilation for residual moisture and condensation to escape. Never cover or plug the bilge drain hole.

- Position the lower unit drive in the DOWN position.

STORING ON A TRAILER

- Be sure the trailer supports are adjusted to properly support your boat's hull.
- Repack the trailer wheel bearings with water-resistant wheel bearing grease.
- Park the trailer and boat in a protected area with the lower unit drive in the DOWN position.
- Loosen tie-downs and winch line, but be sure the boat is resting properly on hull supports.
- Lift the trailer and place blocks under the trailer frame to relieve weight on trailer tires and springs. Position the boat to allow for adequate draining from rain or snow.
- Cover your boat to prevent the collection of rain, snow or debris. When using a cover, allow ventilation for residual moisture and condensation to escape. Never cover or plug the bilge drain hole.

RECOMMISSIONING AFTER STORAGE

- Remove blocks from under the trailer frame.
- Tighten tie-downs and the trailer winch line.
- Check tire pressure and lug nut tightness on the trailer.
- Inspect the hull for damage.
- Charge and install all batteries.
- Check the bilge pump and float switch for proper operation.
- Inspect all battery and electrical wiring for loose connections and/or damage.
- Check the fuel system for leaks or damage.
- Check the engine and bilge for signs of nesting animals; clean as necessary.
- Check the entire engine for cracks and leaks caused by freeze damage.
- Check the condition of all hoses and clamps for tightness.
- Clean the bilge area and install the boat bilge drain plug.
- Lubricate all seacocks and check for proper operation.
- Install all drain plugs in strainers and seacocks.
- Close all drains and valves that were opened during winterization.



Winterization and Storage

- Open all faucets and fill freshwater holding tank with about 20 gallons of water. Turn freshwater pump on to allow water to flow through all faucets before closing them. Thoroughly flush all lines and appliances with fresh water.
- Fill the freshwater tank.
- Perform any annual maintenance not performed during winterization. See the *Engine Operator's Manual* and all equipment manufacturer's information for periodic and annual maintenance procedures.
- Check the engine's cooling water intake areas and screens for obstructions.
- Check all engine and generator exhaust connections for exhaust leakage or damage.
- Check and lubricate the steering system.
- Check all navigational lights.
- Check all controls, gauges, boat systems, accessories and related equipment for proper operation.
- Check all fire extinguishers for charge level.
- Inspect all safety equipment for condition and operation as applicable.
- When possible, briefly start and run the engine(s) using proper water supply equipment to check that the engine does start and there are no major operational problems. *NOTICE: If fogging oil was used during winterization, the engine will emit excessive white smoke upon initial start-up. This condition is normal and will diminish once the fogging oil has been cleared through the engine.*
- Once your boat is in the water, start the engine.
- Start the engine(s) and watch the gauge readings closely, checking for leaks and abnormal noises.
- Keep speeds low for the first 15 minutes until the engine has reached normal operating temperature.
- See the *Engine Operator's Manual* and all equipment manufacturer's information for additional recommendations.



Section 11

LIFTING

NOTICE: Consult your dealer for proper lifting instructions for your boat.

Attempt to lift or hoist boats only if you are qualified or experienced with this procedure. This procedure requires special equipment and experience. Do not attempt to lift or hoist your boat alone; damage, personal injury or death can occur. **WARNING! There are several lifting hazards to be aware of if you need to lift your boat and/or engine. See Safety Precautions in the Safety section of this manual for more details.**

If your boat is to be removed from the water without a trailer, follow these guidelines:

- Cover lifting cables with a rubber hose or other protectors to prevent damage to the finish.
- Attach guidelines to the bow and stern to control movement.
- Use spreader bars and keep lifting pressure vertical to prevent side load damage.
- Keep the bow slightly higher than the stern to prevent engine damage.

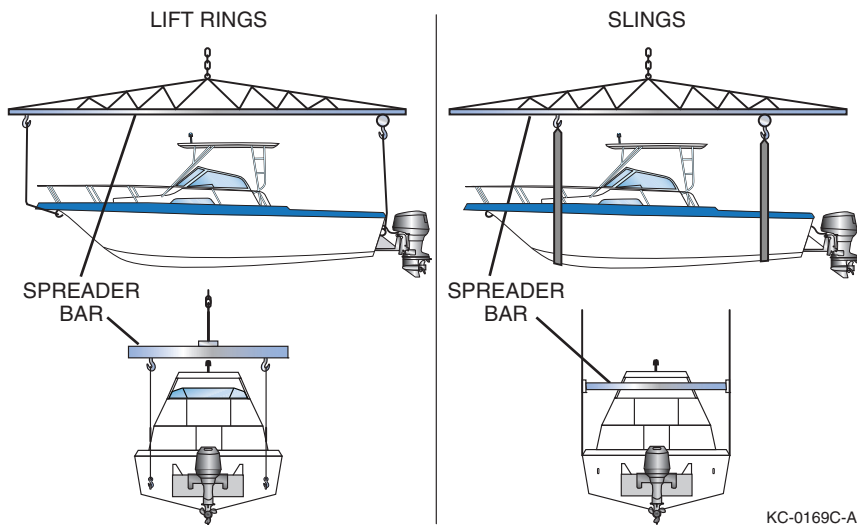

Figure 11-1

KC-0169C-A



Section 12

TROUBLESHOOTING

The following information will assist you in identifying basic performance, mechanical and electrical problems. This information is intended as a general troubleshooting guide and may describe items that are not applicable to your boat.

If you detect a problem with the engine, see the *Engine Operator's Manual*. If you detect an equipment or boat system problem, see the manufacturer's information for that item.

Before performing any troubleshooting procedures within this section, see the *Safety Section* in this manual. **NOTICE:** *Certain problems may require specialized skills and tools. Always consult qualified personnel before making any repairs or modifications.*

Problem	Possible Causes
Engine will not crank	<ul style="list-style-type: none">• Engine emergency stop switch lanyard not connected• Shift/throttle control not in the NEUTRAL position• Main circuit breaker open• Battery switch is in the OFF position• Battery terminals or wiring connections corroded• Low battery voltage• Faulty ignition switch• Engine problem
Engine cranks but will not start	<ul style="list-style-type: none">• No fuel in tank• Fuel tank valves closed to engine• Fuel filter clogged• Flame arrestor dirty, if equipped• Contaminated fuel• Engine problem
Poor boat performance	<ul style="list-style-type: none">• Contaminated fuel• Uneven load distribution• Excessive load• Improper power trim position• Improper trim tab position• Improper propeller selection• Excessive water in bilge• Damaged or obstructed propeller• Marine growth on hull• Damaged hull• Engine system problem• Plugged flame arrestor, if equipped



Section 12

Problem	Possible Causes
Throttle/shifting control problems	<ul style="list-style-type: none"> • Corroded cable • Excessive bends or kinks in cable • Engine system problem
Excessive vibration	<ul style="list-style-type: none"> • Damaged or obstructed propeller • Bent propeller shaft • Engine system problem
Electrical problems	<ul style="list-style-type: none"> • Blown fuse/breaker or open circuit • Loose or corroded wiring connections • Defective switch or gauge • Weak or discharged battery • Loose shore power connection
No power to AC outlets	<ul style="list-style-type: none"> • Ground fault circuit interrupter tripped • Loose shore power connection • AC breaker open • Faulty generator operation
Sink/shower water supply does not operate	<ul style="list-style-type: none"> • Freshwater pump circuit breaker is in the OFF position • Freshwater tank is empty • Freshwater pump is defective • Low battery voltage
Head will not empty	<ul style="list-style-type: none"> • Head circuit breaker is in the OFF position • Low battery voltage • Head seacock closed • Discharge valve closed • Line to holding tank blocked
Erratic or no speedometer reading	<ul style="list-style-type: none"> • Disconnected, kinked or plugged pickup tube or pitot • Speedometer gauge faulty



Section 13

GLOSSARY OF NAUTICAL TERMS

ABOARD – On or in the boat.

ABYC – American Boat and Yacht Council, Inc.

AFLOAT – On the water.

AFT – Toward the rear or stern of the boat.

AGROUND – Touching bottom.

AMIDSHIP – Center or middle of the boat.

ANCHOR – (1) An iron casting shaped to grip the lake bottom to hold the boat. (2) The act of setting the anchor.

ASHORE – On the shore.

ASTERN – Toward the stern.

BAIL – To remove water from the bottom of the boat with a pump, bucket, sponge, etc.

BAITWELL – A miniature livewell used to store and keep live bait alive and healthy.

BEAM – The widest point on the boat.

BEARING – Relative position or direction of an object from the boat.

BILGE – The lowest interior section of the boat hull.

BILGE KEELS – The raised areas or aluminum extrusions on the bottom of a boat that parallel the keel.

BOARDING – To enter the boat.

BOUNDARY WATERS – A body of water between two areas of jurisdiction; i.e., a river between two states.

BOW – The front of the boat.

BULKHEAD – Vertical partition (wall) in a boat.

BUNKS – Carpeted trailer hull supports.

BURDENED BOAT – Term for the boat that must “give-way” to boats with the right-of-way.

CAPACITY PLATE – A plate that provides maximum weight capacity and engine horsepower rating information. It is located in full view of the helm.

CAPSIZE – To turn over.

CAST-OFF – To unfasten mooring lines in preparation for departure.

CENTER LINE – A lengthwise imaginary line which runs fore and aft with the boat’s keel.

CHINE – The point on a boat where the side intersects (meets) the bottom.

CLEAT – A deck fitting with ears to which lines are fastened.

CONSOLE – Also called helm. The steering wheel area of the boat.

CRANKING BATTERY – The main battery used for engine starting and electrical circuits.

CURRENT – Water moving in a horizontal direction.

DECK – The open surface on the boat where the passengers walk.

DEEP-CYCLE BATTERIES – Special long-running batteries which can be repeatedly discharged and recharged without significant loss of power.

DOLLY WHEEL – A rolling jack assembly at the front of the trailer used for positioning the coupler during trailer hookup.

DRAFT – The depth of the boat below the waterline, measured vertically to the lowest part of the hull.

ELECTROLYSIS – The breakup of metals due to the effects of galvanic corrosion.

FATHOM – Unit of depth or measure; 1 fathom equals 6 feet.



Section 13

FENDERS – Objects placed alongside the boat for cushioning. Sometimes called bumpers.

FORE – Toward the front or bow of the boat. Opposite of aft.

FREEBOARD – The distance from the water to the gunwale.

FUEL SENDING UNIT – The electrical device that is mounted on the outside of a built-in fuel tank and controls the dashboard fuel gauge.

GIVE-WAY BOAT – (1) Term for the boat that must take whatever action necessary to keep well clear of the boat with the right-of-way in meeting or crossing situations. (2) The burdened boat.

GUNWALE – The rail or upper edge of a boat's side.

HEAD – A marine toilet.

HELM – The steering wheel or command area.

HULL – The body of the boat.

HYPOTHERMIA – A physical condition where the body loses heat faster than it can produce it.

IN-LINE FUSE – A type of protective fuse located in the power wire of a direct current (DC) circuit usually near the battery.

KEEL – The lowest portion of the boat; extends fore and aft along the boat's bottom.

LIFE JACKET – A buoyant, wearable jacket that, when properly used, will support a person in the water; also see PFD.

LIST – Leaning or tilt of a boat toward the side.

MAKING WAY – Making progress through the water.

MARINE CHART – Seagoing maps showing depths, buoys, navigation aids, etc.

MOORING – An anchor, chain or similar device that holds a boat in one location.

NAVIGATION AID – Recognizable objects on land or sea such as buoys, towers or lights which are used to fix position to identify safe and unsafe waters.

NMMA – National Marine Manufacturers Association.

NO-WAKE SPEED – The speed at which a boat travels to produce an imperceptible wake.

PFD – A buoyant personal flotation device used to support a person in the water; also see Life Jacket.

PITOT TUBE – See *Speedometer Pickup Tube*.

PLANING HULL – A hull designed to lift, thereby reducing friction and increasing efficiency.

PORPOISE – A condition in which the bow bounces up and down caused by trimming the engine too far out.

PORT – (1) The left side of a boat when facing the bow. (2) A destination or harbor.

PRIVILEGED BOAT – Term used for the boat with the right-of-way.

RIGHT-OF-WAY – Term for the boat that has priority in meeting or crossing situations. The stand-on or privileged boat.

RULES OF THE ROAD – Regulations for preventing collisions on the water.

SPEEDOMETER PICKUP TUBE – Also called pitot tube. The plastic device that extends below the bottom of the boat. It connects to the speedometer with plastic flexible tubing.

SPLASHWELL – The section of an outboard-equipped boat that is just forward of the transom.

STAND ON BOAT – Term for the boat that must maintain course and speed in meeting or crossing situations. The privileged boat.

STARBOARD – The right side of the boat when looking toward the bow.

STERN – The back of the boat.

STOW – To pack the cargo.

SURGE BRAKES – A type of trailer braking system designed to automatically actuate when the tow vehicle's brakes are applied.



Glossary of Nautical Terms

TRANSDUCER – The unit that sends/receives signals for the depth sounder.

TRANSOM – The transverse beam across the stern.

TRIM – Fore to aft and side to side balance of the boat when loaded.

UNDER WAY – Boat in motion; i.e., not moored or anchored.

USCG – United States Coast Guard.

WAKE – The waves that a boat leaves behind when moving through the water.

WATERWAY – A navigable body of water.

V-PAD – A modified vee-hull design with a small, flat area in the keel aft.

VISUAL DISTRESS SIGNAL – A device used to signal the need for assistance such as flags, lights and flares.



Section 13

This Page Intentionally Left Blank



INDEX

Numerics

5-pin wiring connector 8-3

A

Accidents 3-2, 4-5
Alcohol 3-2
Aluminum 10-4
American Boat & Yacht Council 1-3
American Red Cross 1-3
Anchor 7-13
Anchor line 7-13
Anchors 7-13
Anodes 11-1
Antifouling bottom paint 10-5
Aquatic vegetation/weeds 5-2
Audible (sound) distress signals 2-11
Audible alarms 9-11
Audible distress signaling devices 2-7, 2-11
Audible distress signals 6-1

B

Backing up 8-5
Basic safety rules 2 -1
Battery 2-4
Bell 6-1
Bilge 10-8
Bilge pump 10-8
Boarding 7-2
Boat owner/operator responsibilities 3-1
Boat Owners Association of
The United States 1-3
Boat system failure 4-4
Boating accident 3-2
Boating regulations 3-1, 6-1
Boating under the influence 3-2
BoatU.S. Foundation for Boating Safety
Hotline 1-3
Buffing 10-5
Buoys 6-4, 6-6, 6-7, 6-8

C

California Air Resources Board (CARB) 3-6
Canvas 10-6
Capacity plate 1-2, 7-2
Capsizing and flooding 4-4
Carbon 2-3
Carbon monoxide poisoning 2-3, 2-13, 4-1

Carpet 10-6
Cell phones 4-1
Chrome 10-4
Circuit breakers 10-2
Cleaners 10-4, 10-5
Cleaning 10-5
Cleaning agents 3-4
Cold water 5-2
Cold weather and cold or frozen water
conditions 5-2
Collision 4-5
Communication equipment 4-1
Compliance plate 1-2
Cooling system 10-5
Corrosion 10-4, 10-5
CPR 4 -1
Crossing 6-3

D

Dams 5-2
Dams and spillways -2
Danger signal 6-1
Daymarks 6-7
Daymarks/dayboards 6-5
Debris 5-2
Depositing refuse 3-4
Detectors 10-8
Discharge of oil 3-4
Distress flags 5-3
Distress signal 3-3
Distress signaling devices 4-1
Distress signals 6-1
Drain plug 11-1
Drugs 3-2
Dual-lever Controls
Controls 9-4

E

Electrolysis 10-4
Emergencies 4-1, 4-5
Emergency assistance 3-3
Emergency checklist 4-1
Emergency Position Indication Radio
Beacons (EPIRBs) 4-1
Emissions 3-5
Engine cooling system 11-1
Engine emergency stop switch 2-4



Engine emergency stop switch and lanyard	2-8
Engine Synchronization Gauge	
Engine Synchronization	9-10
Gauge	9-10
Engine water pressure gauge	9-9
EPIRBs	4-1
Exhaust emissions	3-5

F

Fasteners	10-4
Federal Oil Pollution Act of 1990	3-4
Federal Water Pollution Control Act	3-4
Fire and explosion	4-2
Fire extinguisher	2-8
Fire extinguishers	2-7, 2-8
Fires	2-8
First aid/medical emergencies	4-1
Fishing	3-3
Flags	5-3
Float plan	7-1
Float switch	10-8
Fogging oil	11-1
Foreign aquatic species	3-3
Foreign species transportation	3-3
Freezing temperatures	11-1
Freshwater system	
City water	10-8
Filter(s)	10-8
Fresh water	10-8
Pump	10-8
Tank	10-8
Fuel	10-1
Fuel filler	7-3
Fuel level gauge	
Fuel	9-9
Gauge	9-9
Fuel management	7-3
Fuel stabilizer	11-1
Fuel system	
Fuel	10-1
Fuel filter	10-1
Fuse block	10-2
Fuses	10-2

G

Galvanic corrosion	10-4
Anodes	10-4
Gasoline fume detector indicator	
Alarm	9-11
Gasoline	9-11

Gelcoat	10-5
Glossary of nautical terms	13-1
Green light	6-2
Gross Vehicle Weight Rating (GVWR)	8-1

H

Hazard labels	2-3
Hazards	5-2
Head and waste containment system head (marine toilet)	
Head	10-9
Waste tank	10-9
Helm	7-5, 9-2, 10-3
HIN	1-2
Hitch ball	8-1
Hitch ball and trailer coupler	8-2
Horn	6-1
Hour meter	9-10
Hull identification number	1-2
Hypothermia	4-1, 5-2

I

Icy waters	5-2
Inclement weather	5-1
Insurance	3-2
Isolated danger markers	6-8

L

Lateral markers	6-7
Launching	8-5
Life jackets	2-7
Lifting	11-4
Lighthouses	6-6
Loading	8-6

M

Man overboard	4-3
Manatee	6-8
Marine growth	10-5
Markers	6-4, 6-6, 6-8
Markers, warnings and advisories	5-2
MARPOL	3-4
MARPOL treaty	3-4
MAYDAY	4-1
Meeting head-on	6-3
Mildew	10-5
Minimum on-board personal safety equipment	2-7
Minor lights	6-5, 6-7
Minors	3-2
Mooring line	7-12



N

National Association of State Boating Law Administrators (NASBLA)	1-3
National Marine Manufacturers Association (NMMA)	1-3
National Oceanic and Atmospheric Administration's National Weather Service	1-3
National Safe Boating Council Inc.	1-3
Natural resources	3-3
Nautical terminology	1-1
Navigation lights	2-7
Navigation lights – night operation	6-1
Navigation markers	5-3
Navigational lights	2-11, 6-1
Navigational rules	6-1
No wake	6-2
Noise	3-3

O

Observer	2-14
Oil level gauge	
Gauge	9-11
Oil level	9-11
Oil spills	3-4
Operating under the influence	3-2
Operation by minors	3-2
Organizations	1-3
Overboard dumping	3-4
Overtaking/passing	6-2

P

Paints	3-4
Passengers	7-2
Performance	7-2
Personal flotation devices (PFDs)	2-1
PFDs	
Type I	2-9
Type II	2-9
Type III	2-9
Type IV	2-10
Type V	2-10
Planing	7-7
Platform dragging	2-13
Pollution regulations	3-4
Power Trim/Tilt Gauge	
Gauge	9-10
Trim/Tilt	9-10
Preferred channel markers	6-8
Proposition	65 3-5
Protecting the environment	3-3

Publications	1-2
--------------------	-----

R

Radios	4-1
Range lights	6-5
Range markers	6-7
Raw water system	
Raw water	10-8
Seacocks	10-8
Recommended safety equipment	2-12
Red light	6-2
Reduced visibility	5-1
Refueling	2-4
Refuse Act of 1899	3-4
Registration	3-1
Registration certificates	3-1
Registration numbers	3-1
Regulations	3-2, 3-3, 3-4, 6-2
Regulatory markers	6-6
Reporting accidents	3-2, 4-5
Reporting Safety Defects.....	8-10
Restricted areas	5-2
Restricted visibility	6-1
Right-of-way	6-1
Rode	7-13
Rotational thrust	7-6
Rudder	10-3
Runaway boat	7-1
Running aground	4-4

S

Safe water markers	6-7
Safety	2-1, 7-2
Safety chains	8-3
Safety decals	2-3
Safety equipment	2-12, 10-9
Safety guidelines	2-1
Safety messages	2-3
Safety precautions	2-3
Safety standards	1-2
Safety statements	2-3
Salt water	10-5
Sea Tow Services International, Inc.	1-3
Seals in the engine lower unit	3-3
Shallow water	5-2
Shallow water operation	5-2
Shift controls	9-3, 9-4
Shifting	9-3, 9-4
Shock	5-2
Signs	6-8
Single-lever controls	9-3



Special markers	6-7
Speed	3-3, 6-2
Speed limits	3-3, 6-2
Speedometer	9-9
Spillways	5-2
Spotter	2-14
Stainless steel	10-4
Steering	7-5, 9-2
Steering system	10-3
Storing	11-1
Storm warning	5-3
Surge brakes	8-3
Swimming areas	5-2
Switches	9-12

T

Tachometer	9-9
Teak	10-7
Teak or drag surfing/platform dragging	2-13
Throttle	9-3
Throttle controls	9-3
Thru-hull fittings	11-1
Towing	4-4
Towing hitch	8-1
Towing on the water	4-5
Towing vehicle	8-1
Trailer	8-1, 10-9
Trailer brakes	8-3
Trailer classification	8-1
Trailer regulations	8-1
Trailer type	8-1
Trailer guidelines	8-4
Trim tabs	10-8
Troubleshooting	12-1
Type B fire extinguishers	2-8

U

U.S. Coast Guard (USCG)	1-3, 3-1
U.S. Coast Guard Auxiliary	1-3
U.S. Coast Guard Auxiliary – Float Plan Information	1-3
U.S. Coast Guard Navigation Center (NAVCEN)	1-3
U.S. Coast Guard Office of Boating Safety	1-3
U.S. Coast Guard Pollution Control National Response Center	1-3
U.S. Coast Guard Safety Standards Compliance Plate	1-2
U.S. Coast Guard’s America’s Waterway Watch Program	1-3
U.S. Government Printing Office	1-3

U.S. Power Squadrons	1-3
United States Aids to Navigation System (USATONS)	6-4
Upholstery	10-6
USCG safety standards	1-2

V

Vegetation	5-2
VHF	4-1
VHF-FM radio	4-2
Vinyl cleaner	10-5
Visibility	5-1
Visual distress signaling devices	2-7, 2-10
Visual distress signals (VDS)	2-10
Voltmeter	9-10

W

Wake	3-3, 6-2
Washing	10-5
Waste	3-4
Waste holding tank	10-9
Water depth gauge	9-11
Water hazards	5-2
Water sports guidelines	2-13
Water sports safety	2-13
Water temperature gauge	9-10
Weather	4-4
Whistle	6-1
Window channels	10-7
Windshield	10-7
Winterization and storage Storage	11-1
Winterizing	11-1





Rec Boat Holdings, L.L.C., 925 Frisbie Street Cadillac, MI 49601 Phone (231) 775-1351

WARRANTY REGISTRATION TRANSFER REQUEST

Original Owner Name & Address: _____

Original Date of Purchase: _____

Hull Identification Number: _____

Boat Model: _____

Selling Dealer: _____

Name & address of new owner: _____

Telephone & E-Mail Address _____

Date of Purchase _____

The warranty may be transferred only once. Registration of the second owner is required and the amount of the transfer fee* is indicated in the limited warranty statement for the model year being transferred. Transfer of the remaining warranty must occur within five (5) years of the original retail sale. The transfer fee must be paid within fifteen (15) days of purchase of the used boat by check, money order or cashier's check payable to Rec Boat Holdings, L.L.C.

This warranty registration request if accepted, transfers the warranty coverage remaining on the boat to the new purchaser. Acceptance of this request does not create any additional warranties or obligation on Rec boat Holdings, L.L.C.

Warranty Expiration Date: _____

Wellcraft Transfer Acceptance Date: _____

Wellcraft Authorized signature: _____

Mail to: Rec Boat Holdings, L.L.C.
Attn: Customer Service
925 Frisbie Street
Cadillac, MI 49601

DEPARTMENT OF HOMELAND SECURITY
U.S. Coast Guard
RECREATIONAL BOATING ACCIDENT REPORT

OMB Control Number: 1625-0003

Expires: 12/31/2015

INSTRUCTIONS: Use "Report required because" section below to determine if a report is required for your accident. If required, please have each vessel owner or operator involved in the accident submit a report to their state reporting authority. Each boat operator/owner involved in an accident should submit a separate report. For each question below, please provide answers if applicable and if known; otherwise leave blank. Privacy Act Notice: Authority- 46 U.S.C. 6102 and 33 CFR 173 & 174 authorize the collection of information on boating accidents. Purpose-The Coast Guard uses this information for statistical purposes, chiefly to inform the public, to measure the Program's efforts, and to regulate issues relating to boating safety. Routine Uses-The Coast Guard shares this information within the agency, and if state and federal law permit it, to the public.

REPORT SUBMISSION

Report required because (select all that apply):

- At least one person in this accident *died*: If so, how many? _____
- At least one injured person in this accident *required or was in need of treatment beyond first aid*: If so, how many? _____
- At least one person in this accident *disappeared* and has not yet been recovered: If so, how many? _____
- All boat and other property *damage* (e.g., fishing/hunting gear) caused by this accident *totaled* (or likely totaled) \$2,000 or more:
 Approximate value of damage to *your* boat: \$ _____
 Approximate value of damage to *your* other property: \$ _____
- Your or another *boat* in this accident was (or likely was) a *total loss*

To be submitted within:

48 hours (if injury, disappearance or death)
10 days (if boat/property damage only)

To be submitted to: (Local State Reporting Authority)

Phone:

You may submit any comments concerning the accuracy of the burden estimate or any suggestions for reducing the burden to: Commandant (CG-5422), U.S. Coast Guard, Washington, DC 20593-0001 or Office of Management and Budget, Paperwork Reduction Project (1625-0003), Washington, DC 20503. Questions relating to the collection of this data should be sent to the Coast Guard.

Report submitted by (select all that apply):

- Boat Operator (required if possible)
- Boat Owner (if operator unable, or same as operator)
- Other (describe): _____

For State Agency Use Only

First Name	Last Name
Phone:	

First Name	Last Name	Phone	Primary Cause of Accident
------------	-----------	-------	---------------------------

ACCIDENT SUMMARY

WHEN	ACCIDENT DESCRIPTION: Briefly describe this accident (attach extra pages if necessary)
Date: (mm/dd/yyyy) Time: am <input type="checkbox"/> pm <input type="checkbox"/> (select one)	
WHERE	
Body of Water Name	

Location (on water) description	DAMAGE TO YOUR BOAT: Briefly summarize any damage to your boat
Nearest city/town	
County: State:	

YOUR BOAT – PEOPLE	DAMAGE TO YOUR OTHER PROPERTY: (NOT BOAT) Briefly summarize any damage to your other property (not boat)
# people on board (including operator):	
# people being towed (e.g., on tubes, skis):	
# people wearing lifejackets (on board or towed):	
OTHER BOATS INVOLVED IN ACCIDENT	
# of other boats involved:	

For each question below, please provide answers IF APPLICABLE AND IF KNOWN, otherwise leave blank.

YOUR BOAT

BOAT IDENTIFICATION

Your Boat Name:										Manufacturer:									
Model Name:										Model Year:									
Registration #:										Documentation #:									
Hull Identification # (HIN)										Rented: <input type="checkbox"/> Yes <input type="checkbox"/> No									

SIZE ESTIMATES

Length: ft.	Depth from transom (stern) to keel (bottommost point): ft. in.	Beam width at widest point: ft.
-------------	--	---------------------------------

HULL MATERIAL

Type of Hull Material (select one)															
Fiberglass				Wood				Rubber/vinyl/canvas				Other (describe):			
Aluminum				Steel				Plastic							

BOAT TYPE

Boat Type (select one)								Available Propulsion (select all that apply)									
Cabin motorboat		Inflatable		Canoe		Personal watercraft (PWC) (e.g., Wave Runner™, Jet Ski™, Sea-Doo™)				Propeller				Air thrust			
Open motorboat		Houseboat		Rowboat						Sail				Other (describe):			
Auxiliary sail		Sail (only)		Air boat		Other (describe)				Manual							
Pontoon boat		Kayak								Water jet							

ENGINE

# Engines				Engine type and horsepower (select one)								Fuel type (select all that apply)					
Manufacturer				Outboard		Sterndrive (I/O)		Inboard		None		Gasoline		Diesel		Electric	
				Total horsepower: hp													

SAFETY MEASURES

Organizations that have conducted a vessel safety check (VSC) on board your boat within the past year (including carriage of safety equipment, e.g., lifejackets, anchor and line, fire extinguishers):

US Coast Guard Auxiliary: VSC Decal? <input type="checkbox"/> Yes <input type="checkbox"/> No	Federal Agency (Name)
US Power Squadrons: VSC Decal? <input type="checkbox"/> Yes <input type="checkbox"/> No	State Agency (Name)
	Other Agency (Name)

# Life jackets on board:	# Fire extinguishers on board:	Type of fire extinguishers (e.g., ABC):
	# Fire extinguishers used:	Amount of fire extinguishers used:

ACCIDENT DETAILS – EXTERNAL CONDITIONS

WEATHER

Overall weather was (select one)				It was (select one)		Visibility was (select one)				Wind was (select one)			
Clear		Raining		Day		Good				0 mph (none)			
Cloudy		Snowing		Night		Fair				Over 0, up to 12 mph (light)			
Foggy		Hazy				Poor				Over 12, up to 25 mph (moderate)			
Other (describe):				Approximate air temperature: °F				Over 25, up to 55 mph (strong)					
								Over 55 mph (stormy)					

WATER

Overall water conditions (select one):						Other water conditions:					
Up to 6 in. waves (calm)						Approximate water temperature: °F					
Over 6 in., up to 2 ft. waves (choppy)						Strong current?			Yes No		
Over 2 ft., up to 6 ft. waves (rough)						Hazardous waters? (e.g., rapid tidal flow, currents)			Yes No		
Over 6 ft. waves (very rough)						Congested waters?			Yes No		

For each question below, please provide answers IF APPLICABLE AND IF KNOWN, otherwise leave blank.

ACCIDENT DETAILS – ACTIVITIES AND OPERATIONS ON YOUR BOAT

OPERATOR/PASSENGER ACTIVITIES

Operator/passenger activities on *your* boat at time of accident:

Activities were (select one)

Operator/Passenger activities (select all that apply)

Recreational	Fishing	Tubing	Starting engine
Commercial	Hunting	Water Skiing	Making repairs
	White water activity (e.g., rafting)	Relaxing	Other (list):

BOAT OPERATIONS

Your boat operations at time of accident (select all that apply)

Cruising (underway under power)	Drifting	Racing	Towing another vessel
Changing direction	At anchor	Rowing/paddling	Launching
Changing speed	Being towed	Docking/undocking	Tied to dock/mooring
Sailing	Other (list)		

ACCIDENT DETAILS – CONTRIBUTING FACTORS ON YOUR BOAT

CONTRIBUTING FACTORS

Indicate factors on *your* boat which may have contributed to this accident (select all that apply)

Alcohol use	Improper lookout	Dam/lock	Starting in gear
Drug use	Operator inattention	Force of wake/wave	Sharp turn
Excessive speed	Operator inexperience	Hazardous waters	Restricted vision (e.g., fog)
Improper anchoring	Language barrier	Heavy weather	Mission/inadequate aids to navigation (e.g., buoy, daymarker)
Improper loading	Navigation rules violation	Ignition of fuel or vapor	Inadequate on-board navigation lights
Overloading	Failure to vent	Hull failure	People on gunwale, bow or transom
Other (describe):			

ACCIDENT DETAILS – YOUR BOAT

MACHINERY/EQUIPMENT FAILURE

Failure of the following machinery/equipment on *your* boat contributed to this accident (select all that apply)

Engine	Onboard lights	Shift	Sound equipment (e.g., horn, whistle)
Electrical system	Seats	Radio	Auxiliary equipment
Fuel system	Steering	Fire extinguisher	Other (list):
Sail/mast	Throttle	Ventilation	
Onboard navigation aids (e.g., GPS)			

ACCIDENT DETAILS – EVENTS ON YOUR BOAT

ACCIDENT EVENTS

Types of events occurring to/on *your* boat during accident (select all that apply)

Collision with recreational boat	Flooding/swamping	Person fell overboard
Collision with commercial boat (e.g., tug, barge)	Fire/explosion – fuel	Person fell on/within boat
Collision with fixed object (e.g., dock, bridge)	Fire/explosion – non-fuel	Sudden medical condition
Collision with submerged object (e.g., stump, cable)	Carbon monoxide exposure	Person struck by boat
Collision with floating object (e.g., log, buoy)	Mishap of skier, tuber, wake boarder, etc.	Person struck by propeller or propulsion unit
Capsizing	Person left boat voluntarily	Person electrocuted
Grounding	Person ejected from boat (caused by collision or maneuver)	
Sinking	Other (describe)	

For each question below, please provide answers IF APPLICABLE AND IF KNOWN, otherwise leave blank.

**ACCIDENT DETAILS –YOUR BOAT-
INJURED PEOPLE RECEIVING OR IN NEED OF TREATMENT BEYOND FIRST AID**

Report only injured people on, struck by, or being towed by your boat, receiving or in need of treatment beyond first aid. Do not report injured people on, struck by, or being towed by another boat or no boat (e.g., swimmers, people on a dock). If more than one injured person to report, attach additional copies of this page. If none, SKIP INJURED PEOPLE section.

INJURED PERSON

First Name	MI	Last Name
Street		
City	State	Zip
Phone	Date of Birth (mm/dd/yyyy)	Age

INJURY DETAILS

Injury caused when person (select all that apply)	Nature of most serious injury (select one)
Struck the (e.g., boat, water):	Scrape/bruise Dislocation
Was struck by a (e.g., boat, propeller):	Cut Internal organ injury
Was exposed to carbon monoxide poisoning	Sprain/strain Amputation
Received an electric shock	Concussion/brain injury Burn
Other (describe):	Spinal cord injury Other (describe):
Person was wearing lifejacket?	Broken/fractured bone
Person received treatment beyond first aid?	Body part of most serious injury (e.g., head, trunk, leg):
Person was admitted to a hospital?	

ACCIDENT DETAILS – YOUR BOAT – DEATHS/DISAPPEARANCES

Only report deaths/disappearances of people on, struck by, or being towed by your boat. If more than one death/disappearance to report, attach additional copies of this page. If none, SKIP DEATHS/DISAPPEARANCES section.

PERSON WHO DIED/DISAPPEARED

First Name	MI	Last Name
Street		
City	State	Zip
Phone	Date of Birth (mm/dd/yyyy)	Age

DETAILS OF DEATH/DISAPPEARANCE

Injury caused when person (select all that apply)	Nature of death/disappearance (select one)
Struck the (e.g., boat, water):	Death – by drowning
Was struck by a (e.g., boat, propeller):	Death – other likely cause (describe)
Was exposed to carbon monoxide poisoning	
Received an electric shock	Disappeared and not yet recovered
Other (describe):	Person was wearing lifejacket? Yes No

For each question below, please provide answers IF APPLICABLE AND IF KNOWN, otherwise leave blank.

ACCIDENT DETAILS – YOUR BOAT OPERATOR

OPERATOR INSTRUCTION		OPERATOR SAFETY MEASURES			
Boating safety instruction completed <i>(select all that apply)</i>		On board, prior to accident, was operator wearing:			
	None	A lifejacket?		Yes	No
	State course	An engine cut-off switch <i>(Lanyard or wireless device)</i> if equipped?		Yes	No
	USCG Auxiliary course	On board, prior to accident, was operator using:			
	US Power Squadrons course	Alcohol?		Yes	No
	Internet <i>(name of sponsoring organization)</i>	Drugs?		Yes	No
	Other <i>(describe)</i>	Operator arrested for Boating Under the Influence?			
				Yes	No
		Weather reports consulted prior to accident?		Yes	No

OPERATOR EXPERIENCE			
Experience operating this type of boat <i>(select one)</i>			
	0 to 10 hours	Over 10, up to 100 hours	Over 100, up to 500 hours
			Over 500 hours

ACCIDENT DETAILS – OTHER KEY PEOPLE

Only report other key people not already documented as injured, died, disappeared or operator/owner of your boat. If more than two other key people to report, attach additional copies of this page.

NAME/ADDRESS			
This other key person was a(n) <i>(select all that apply)</i>			
<input type="checkbox"/> Other boat operator <input type="checkbox"/> Other boat owner <input type="checkbox"/> Owner of other damaged property <input type="checkbox"/> Passenger on your boat <input type="checkbox"/> Witness			
First Name	MI	Last Name	
Street			
City	State	Zip	Phone
Other boat name <i>(if any)</i>		Other boat registration # <i>(if any)</i>	

NAME/ADDRESS			
This other key person was a(n) <i>(select all that apply)</i>			
<input type="checkbox"/> Other boat operator <input type="checkbox"/> Other boat owner <input type="checkbox"/> Owner of other damaged property <input type="checkbox"/> Passenger on your boat <input type="checkbox"/> Witness			
First Name	MI	Last Name	
Street			
City	State	Zip	Phone
Other boat name <i>(if any)</i>		Other boat registration # <i>(if any)</i>	

For each question below, please provide answers IF APPLICABLE AND IF KNOWN, otherwise leave blank.

YOUR BOAT OPERATOR

NAME/ADDRESS

First Name	MI	Last Name
Street		
City	State	Zip

AGE/GENDER/PHONE

Date of Birth <i>(mm/dd/yyyy)</i>	Age	Gender	Male	Female	Phone
--------------------------------------	-----	--------	------	--------	-------

YOUR BOAT OWNER

If same as *your boat operator* SKIP rest of YOUR BOAT OWNER section.

NAME/ADDRESS/PHONE

First Name	MI	Last Name	
Street			
City	State	Zip	Phone

PERSON SUBMITTING THIS REPORT

If same as *your boat operator* OR *owner*, SKIP rest of PERSON SUBMITTING THIS REPORT section.

NAME/ADDRESS/PHONE/ROLE

First Name	MI	Last Name	
Street			
City	State	Zip	Phone

I was a(n) *(select one)*

<input type="checkbox"/>	Other person on board <i>this</i> boat
<input type="checkbox"/>	Accident witness <i>not</i> on board <i>this</i> boat
<input type="checkbox"/>	Other <i>(describe)</i> :

SIGNATURE OF PERSON SUBMITTING THIS REPORT

Your signature	Date <i>(mm/dd/yyyy)</i>
-----------------------	---------------------------------

An Agency may not conduct or sponsor and a person is not required to respond to an information collection, unless it displays a currently valid OMB Control Number.

The Coast Guard estimates that the average burden for this report form is 30 minutes. You may submit any comments concerning the accuracy of this burden estimate or any suggestions for reducing the burden to: Commandant (CG-5422), U.S. Coast Guard, Washington, DC 20593-0001 or Office of Management and Budget, Paperwork Reduction Project (1625-0003), Washington, DC 20503.



www.wellcraft.com

© Rec Boat Holdings, LLC dba Wellcraft
925 Frisbie Street, Cadillac, MI 49601
231-775-1351