

Table of Contents

INTRODUCTION	1-1
Play It Safe and Enjoy!	1-1
Tigé Tips for a Safe, Fun Day on the Water!	1-2
Owner's Kit	1-2
Intended Use	1-3
Owner Responsibility for Warranty Procedure	1-4
Certifications	1-5
Features and Technology	1-6
Serial Number Locations	1-8
Owner/Operator Responsibilities	1-9
Qualified Boat Operators	1-11
Education Opportunities	1-11
Federal, State and Local Regulations	1-12
Reporting Accidents	1-12
Rendering Assistance	1-12
Our Environment	1-13
Warning Labels	1-15
Restricted Areas	1-16
California Proposition 65	1-16
Emission Control Warranty Information	1-16
Boating Terminology	1-17
Specifications	1-18
Warranty	1-19
SAFETY	2-1
Safety While Boating	2-1
General Precautions	2-3
Signal Words/Definitions	2-4
Required Safety Equipment	2-5
Safety and Maintenance	2-10
Emergency Considerations	2-10
Hazardous Conditions	2-14
Boating Under the Influence	2-16
Skill/Experience	2-16
Carbon Monoxide	2-17
Operation by Minors	2-17

OWNER'S MANUAL

TABLE OF CONTENTS

Communication	2-18
Water Sport and Towing Safety	2-19
Safety Alert from August 28, 2001	2-20
Trailer Safety	2-24
BASIC RULES OF THE ROAD	3-1
Aids to Navigation	3-1
FEATURES	4-1
General Layouts	4-1
Dash Panels	4-6
Switches, Controls, Ports, Gauges and Indicators	4-10
Controls	4-16
Ports	4-19
Gauges	4-20
Circuit Breaker Panel	4-23
Fuses	4-24
Cockpit and Exterior	4-24
OPERATION	5-1
Getting Underway	5-1
Preflight Checklist	5-2
Fueling	5-4
Shifting/Running	5-5
Steering	5-6
Stopping	5-6
Docking	5-7
Starting	5-9
TAPS ² Operation	5-10
Water Sports Settings	5-11
Tigé SpeedSet Cruise Control Operations	5-13
Safety Equipment	5-16
Boarding	5-16
Boat Loading	5-16
Running	5-17
Maneuvering Techniques	5-18
Salt Water	5-19
Freezing Temperatures	5-19
Towing Procedure	5-20

Anchoring	5-21
Performance Boating	5-23
Propellers	5-25
BOAT SYSTEMS	6-1
Steering	6-2
Engines	6-3
Transmissions	6-3
Strut and Bearing	6-4
Electrical System	6-5
Fuel System	6-5
Ballast Tank System (optional)	6-6
Bilge Systems	6-6
Shower System	6-8
Schematic and System Illustrations	6-9
CARE AND MAINTENANCE	7-1
General Maintenance	7-2
Interior	7-3
Bilge Pump and Bilge Area	7-6
Exterior	7-7
Gelcoat Maintenance	7-8
Stainless Steel and Chrome	7-10
Teak Swim Platform	7-11
Propeller	7-12
Saltwater Boating	7-13
Battery Maintenance	7-14
Transmission Oil Level Inspection	7-16
Steering	7-18
Unscheduled Maintenance	7-18
Slings/Lifting the Boat	7-20
Storage/Winterization	7-22
TROUBLESHOOTING AND SERVICE REQUIREMENTS	8-1
Troubleshooting	8-1
Service Requirements	8-4
Fuel Log	8-12
Float Plan	8-13



Section 1

INTRODUCTION

Congratulations on your purchase of a Tigé, the world's most unique multi-sport inboard! We're confident you will enjoy Tigé's extraordinary blend of world-class water sports performance, incredible versatility and outstanding user convenience.

Before using your new Tigé, we encourage you to thoroughly review this owner's manual and familiarize yourself with your boat's operational and safety features.

We have made every effort to ensure the accuracy of this manual, providing the most current information available. Since we are continuously refining features and design, Tigé periodically makes changes to models, systems and specifications. These changes are included in an updated online version of this owner's manual available at www.tige.com.

If you have any questions concerning your new Tigé or this manual, please contact your Tigé dealer. Once again, thanks for choosing Tigé. Have a great time!

PLAY IT SAFE AND ENJOY!

Safety is a top priority in the design and construction of every Tigé boat. Before use, we strongly encourage owners and operators to become familiar with Tigé safety features, safe operation, maintenance procedures and overall safe boating practices. In addition to ensuring your safety and that of your passengers, proper maintenance and operation of your Tigé greatly enhance your enjoyment on the water.





TIGÉ TIPS FOR A SAFE, FUN DAY ON THE WATER

A day on the water may be relaxing for you, but cruising through chop, towing skiers and other normal boating activity puts significant stress on a boat. Although your Tigé is built tough to withstand the rigors of on-water activities, you should check and tighten pylons, towers, accessories and other attachments every time you go out to avoid injury and ensure safe reliable performance. It is also very important to regularly check and maintain the various systems and equipment on your boat before you get underway.

To help you keep everything in good working order, refer to the **Preflight Checklist** in Section 5 each time you go boating. Make it a habit and you'll make the most out of your time on the water.

OWNER'S KIT

The Owner's Kit contains the owner's manual and may include other information about accessories or components offered with your Tigé boat. This information is provided by the manufacturers of those products and should be read, kept and referred to whenever you are using the accessory or component, or before you put it into use. Refer to these manufacturers' manuals for additional operation and maintenance instructions not covered in this manual.

Owner's Manual

The owner's manual contains information concerning the operation and care of your boat. The descriptions contained within the manual will introduce you to features of Tigé and provide you the general knowledge of how the boat works. Become familiar with the information in each section before you use your boat.

This manual was created following International Organization for Standards (ISO) 10240:2004 as a guideline. Not all information conforming to the standards set forth by ISO can be included in this manual without certain manufacturers' consent of the equipment included on your boat. This owner's manual contains information on safety, proper boat operation and maintenance.

Even if everything has been planned and designed for the safety of the boat and its users, boating is still highly dependent on the weather conditions, water conditions, and the experience of you and your passengers. One can never ensure full safety. It is your responsibility as the owner or user to know the boat's equipment, capabilities and intended use.

The specific information on the operation of the equipment and systems on your boat should be supplied by that manufacturer. Read, understand and keep all the information supplied, and familiarize yourself and all users with the boat before you put it into use.

INTENDED USE

Your Tigé boat is intended for use as a pleasure and sport craft and a Craft Design Category of:

Inshore – Category C

Craft designed to operate in winds up to Beaufort force 6 and the associated wave heights and significant wave heights up to 6'6.7" (2 m). Such conditions may be encountered in exposed inland waters, in estuaries, and in coastal waters in moderate weather conditions.

OWNER RESPONSIBILITY FOR WARRANTY PROCEDURE

Before Operating

Before operating your new Tigé boat, it is necessary that you read and understand this manual and the warranty, and that you take the time to read about other accessories or components offered with your Tigé boat.

Warranty Service Requirements

All Tigé warranty service must be completed by an Tigé Dealer. If you are not able to return your boat to your dealership, contact them so they can assist you in coordinating the warranty service. Any claims against Tigé Boats without prior approval from Tigé Boats on repairs completed by an unauthorized dealership may be denied.

If You Sell Your Tigé Boat

Your warranties are transferable. If you choose to sell your Tigé boat to anyone other than a Tigé Dealer, contact Tigé Boats for the appropriate warranty transfer information: www.tige.com or 325.676.7777. If the transfer procedures are not followed, future warranty service may be denied.

CERTIFICATIONS

National Marine Manufacturers Association (NMMA)

Tigé Boats is a member of the NMMA. This independent organization's members include boat, engine and marine equipment manufacturers that are focused on the improvement and safety of boating.

Your new Tigé boat is NMMA certified. An NMMA certification not only satisfies the U.S. Coast Guard (USCG) regulations but also the more rigorous equipment and system standards based on those established by the American Boat and Yacht Council, Inc. (ABYC). Your Tigé boat meets or exceeds NMMA safety-based certifications.

MarinePower®

MarinePower® works closely with Tigé to ensure that its engines deliver maximum performance, reliability and customer satisfaction. Part of this commitment is a certification program that provides Tigé dealers and service technicians with ongoing training and information about MarinePower® engines. Certified MarinePower® service personnel must attend periodic service schools held at the Tigé headquarters. The training includes review of all manufacturing and installation processes, proper servicing procedures as well as existing and developing engine technologies.

FEATURES AND TECHNOLOGY

Convex V Hull/TAPS²

The unique, patented shape of the Tigé Convex V hull combined with TAPS² technology are key Tigé's superior multi-sport versatility, incredible performance and unmatched ride. All other inboard hulls curve down with a "hook" toward the transom and must rely on heavy ballast or drag hardware to produce even entry-level wakeboarding wakes. The Convex V hull curves up in a rocker shape like a wakeboard or slalom ski. Tigé uses its breakthrough TAPS² technology to control hull running attitude and wake characteristics. At wakeboarding speed with TAPS² in the up position, the bow rises and the Convex V hull settles naturally, creating tremendous water displacement and huge world-class wakes without ballast or drag hardware. A push of a button adjusts TAPS² down, lowers the bow and creates instant planning and slalom type wakes.

Ride, handling and fuel efficiency are also dramatically enhanced, allowing Tigé to deliver outstanding overall performance unmatched by any other inboard.

Tigé SpeedSet

Available as an option on all Tigé models, Tigé SpeedSet is the most advanced precision digital speed control in the marine industry. It is also the easiest to use. The SpeedSet control panel incorporates Touchpad Recognition for easy fingertip use without taking your eyes off the waterway. SpeedSet readouts are displayed on the heads-up digital monitor located on the dash. For added safety, the SpeedSet control panel is conveniently located adjacent to the throttle for quick, easy access with your throttle hand. SpeedSet operation is precise, multi-functional and simple. You can even preset a preferred speed and precisely hit that speed set after set. Perfect double-ups and consistent towing speeds are now at your fingertips.

Tigé GM Vortec Engines

Key to the system is the Tigé GM Vortec engine. Exclusive to Tigé, these fuel-efficient, highly reliable engines include proprietary marinization and calibration by MarinePower and are available in four power options. In addition to advanced MEFI-5 electronics, the innovation manifold design developed by MarinePower enhances exhaust flow for a significant increase in engine performance, fuel efficiency and horsepower. Tigé GM Vortec delivers superior power, outstanding overall performance and reliability.

Advanced MEFI-5 and CAN bus Technology

TEC (Tigé Electronic Control) components are in constant communication with the engine's computerized ECM using advanced MEFI-5 electronics. State-of-the-art CAN bus technology allows components to communicate hundreds of times a second over a simple, reliable, two-wire system. Keeping the juice flowing and the electronics humming is our Central Electronic Distribution Center (CEDC), which increases electrical system reliability and efficiency through circuit simplification and load management. CEDC also stabilizes electrical output throughout the boat, significantly reducing power spikes.

Throttle-By-Wire

Electronic throttle-control technology delivers smooth, precise throttle control — a dramatic improvement over traditional mechanical throttle cable systems. No more crimped or broken throttle cables to replace or interrupt the fun. Using the CAN bus link, the throttle communicates electronically with the engine's computerized Engine Control Module (ECM). Power settings are precise, speed adjustment is instant and integration with Tigé SpeedSet cruise control is seamless.

Product Improvement

Because of Tigé's commitment to continuous product improvement, the illustrations used in this manual may not exactly match your boat and are intended only as representation for reference views. Some illustrations may also show optional accessories which may or may not be available for your boat. Some optional accessories can only be installed at the time the boat is manufactured and cannot be installed by your dealer. Your dealer can help with any questions you may have on options which can be added to your boat.

SERIAL NUMBER LOCATIONS

Your Tigé boat, its engine, propulsion unit and other equipment onboard are identified with a serial number. These identification numbers associated with your boat are extremely important. Prepare a list of all serial number items and store it in a safe place other than onboard the boat. Refer to the equipment operator's manuals supplied in your owner's kit for location of serial numbers.

Record these numbers below.

Hull Identification Number (HIN):

Located at the top, right (starboard) corner of the transom.

HIN: _____

Ignition Key, a key tag, is also provided with the keys; store tag or destroy.

Key Number: _____

Registration Number/State: _____

Date of Purchase: _____

Dealership Name and Address: _____

Phone: _____

Salesperson: _____

Engine:

Engine Serial Number: _____

Engine Manufacturer: _____

Model: _____ Horsepower: _____

Transmission:

Transmission Serial Number: _____

Model: _____

Trailer:

Serial Number: _____

Manufacturer: _____

OWNER/OPERATOR RESPONSIBILITIES

At the time of delivery, the owner/operator is responsible for:

- ✦ Understanding warranty terms and conditions of both the engine and boat.
- ✦ Obtaining insurance.
- ✦ Examining boat to ensure proper operation of all systems.

Before operating the boat, the owner/operator is responsible for:

- ✦ Obtaining state registration of the boat.
- ✦ Providing the proper USCG-required safety equipment.
- ✦ Following proper break-in procedure for the engine.
- ✦ Understanding safety information and proper operating procedures within this manual.



While operating the boat, the owner/operator is responsible for:

- Knowing that all safety equipment and personal flotation devices (PFDs) are in good condition and suitable for your boat and passenger load.
- Having at least one other passenger who is capable of handling the boat in an emergency.
- Following safe operating practices and the “Rules of the Road.”
- Understanding proper maintenance and knowledge of the boat’s operating systems.
- Providing safety training for the passengers.
- Avoiding use of alcohol and other drugs.
- Providing assistance to other boaters.

Insurance

You must get insurance before operating your new boat. Insurance for loss by fire, theft or other causes, or liability protection against accidents is a must for responsible boaters. The boat owner is legally responsible for any damage or injury caused when he, or someone else operating the boat, is involved in an accident. Many states have laws detailing minimum insurance needs. Your insurance agent or dealer may be able to supply you with more information.

Registration/Documentation

The USCG requires that all power boats operated on the navigable waters of the U.S. be registered in the state of main use; also, many states require registration in that state whenever boating on waters within their state boundary. Contact your state boating authorities (and neighboring states) for registration information on boats and trailers.

Your dealer can supply you with the appropriate forms.

QUALIFIED BOAT OPERATORS

This manual is not intended to provide complete training on all aspects of boat operation. We strongly recommend that all operators of this boat seek additional training on boat handling and safety. Have all operators become familiar with the handling characteristics and proper steering and control system usage before attempting high-speed operation.

Some states require youths 16 years of age and younger to complete a boating safety course before operating any watercraft. Many others require operators under the age of 18 to be licensed in small boat operation.

EDUCATION OPPORTUNITIES

Be boat smart from the start, take a boating safety course and get a free vessel safety check annually for your boat. For more information, contact:

United States Coast Guard Auxiliary, www.cgaux.org;

United States Power Squadrons, 888-FOR-USPS, www.usps.org.

Most boaters can enhance their enjoyment of boating experiences through increased knowledge of safe operation, navigation and regulation of pleasure boats. The following is a list of some other agencies and organizations that offer Water Safety, First Aid and CPR courses or information. To find boating safety courses in your area, call your state’s local boating agency or the USCG boating safety course line at 800-336-2628 (800-245-2628 in Virginia).

- American Red Cross
- State Boating Offices
- Canadian Power and Sail Squadrons
- Boat Owners Association of the United States
- National Safe Boating Council
- American Water Ski Association (AWSA)



FEDERAL, STATE AND LOCAL REGULATIONS

The U.S. Coast Guard (USCG) is the authority of the waterways; they are there to help the boating public. State boating regulations are enforced by local authorities. You are subject to marine traffic laws and “Rules of the Road” for both federal and state waterways. You must stop if signaled to do so by enforcement officers, and permit to be boarded as asked.

REPORTING ACCIDENTS

The USCG requires the owner or operator of a boat involved in an accident to report the incident to the proper marine law enforcement agency for the state in which the accident occurred.

Immediate notification to the nearest State boating authority is required if a person dies or disappears as a result of a recreational boating accident. If a person dies or sustains injuries requiring more than first aid, a formal report must be filed within 48 hours of the accident. A formal report must be filed within 10 days for accidents exceeding \$500 in property damage or complete loss of boat.

RENDERING ASSISTANCE

If you see a distress signal or suspect a boat is in trouble, you must assume it is a real emergency and render assistance immediately. By law, the operator in charge of the craft is obligated to provide assistance to any individual in danger if such assistance can be provided safely. Failure to render assistance can result in a fine and/or imprisonment.

The 1971 Boating Safety Act grants protection to a “Good Samaritan” boater providing good faith assistance, and absolves a boater from any civil liability arising from such assistance.

OUR ENVIRONMENT

As a boater, you already have an appreciation for nature’s beauty and the peace of the great outdoors. It is a boater’s responsibility to protect the natural environment by keeping waterways clean.

Foreign Species

If you trailer your boat from lake to lake, you may unknowingly introduce a foreign aquatic species from one lake to the next.

Thoroughly clean the boat and trailer below the water line, remove all weeds and algae, and drain the bilge and ballast tanks, if equipped, before launching the boat in a new body of water.

Fuel/Oil Spillage

 WARNING
FIRE/EXPLOSION HAZARD/ASPHYXIATION HAZARD Fumes from flammable solvents can cause fire, explosion or asphyxiation. Make sure ventilation is adequate, wear proper personal protection and dispose of rags properly ashore. DO NOT use flammable solvents to clean the bilge.

The spilling of fuel or oil into our waterways contaminates the environment and is dangerous to wildlife. **DO NOT** discharge or dispose of fuel, oil or other chemicals into the water; it is prohibited and you can be fined. **DO NOT** overfill the fuel tank, pump contaminated bilge water or discard soiled rags into the water.

Discharge/Disposal of Waste

Waste means all forms of garbage, plastics, recyclables, food, wood, detergents, sewage and even fish parts in certain waters, essentially anything. Bring back everything you take out and dispose of in an environmentally friendly manner ashore.

Excessive Noise

Noise means engine noise, radio noise or even voices. Many bodies of water have adopted noise limits. Music and loud conversation can carry a considerable distance on water, especially at night. Make sure to follow regulations and be courteous.

Wake/Wash

Be alert for NO WAKE zones. Prior to entering a NO WAKE zone, come off plane to the slowest steerable speed. Use caution when operating around smaller crafts, in channels and marinas, and in congested areas.

Exhaust Emissions

Increased exhaust (hydrocarbon) emissions pollute our water and air. Keep your engine tuned and boat hull clean for peak performance.

Paints

If your boat is kept in water where marine growth is a problem, the use of anti-fouling paint may reduce the growth rate. Be aware of environmental regulations that may govern your paint choice.

Contact your local boating authorities for information.

Cleaning Agents

Household cleaners should be used sparingly and not discharged into waterways. DO NOT mix cleaners and be sure to use plenty of ventilation in enclosed areas. DO NOT use products which contain phosphates, chlorine, solvents, or non-biodegradable or petroleum-based products.

MARPOL Treaty

The USCG enforces the International Convention for the Prevention of Pollution from ships, commonly referred to as the MARPOL Treaty (MARine POLLution). This treaty prohibits the overboard dumping of all ship-generated plastics, chemicals, garbage and oil.

WARNING LABELS

The warning labels on your Tigé boat must remain legible. If a label is damaged or you suspect a label is missing, contact your Tigé Dealer for immediate replacement.

There are several labels placed throughout the boat to warn you about potential hazards.

All persons should wear a suitable life preserver/personal flotation device when on deck, especially children, disabled people and nonswimmers. Inform all passengers on the proper use of personal flotation devices and of the location of safety equipment, man overboard recovery equipment and the location and deployment of the ladder.

In some countries it is a legal requirement to wear a suitable life preserver/personal flotation device that complies with those countries' regulations at all times.

RESTRICTED AREAS

Before boating, check with local, state and federal authorities to identify restricted areas. Because of the threat of terrorism, the U.S. Coast Guard has implemented and will continue to enforce strict limits on watercraft near U.S. Navy and Coast Guard ships and other potential targets.

CALIFORNIA PROPOSITION 65



WARNING

The engine exhaust from this product contains chemicals known to the State of California to cause cancer, birth defects or other reproductive harm.



WARNING

Diesel engine exhaust and some of its constituents are known to the State of California to cause cancer, birth defects and other reproductive harm.

EMISSION CONTROL WARRANTY INFORMATION

The engine in your Tigé boat meets the strict requirements set forth by the California Air Resources Board (CARB). The engine has a special environmental tag and the boat has this label affixed to it. The tag and the label are required by CARB. The label has 1, 2, 3 or 4 stars. The label MUST be affixed to the boat if the boat is operated in the state of California and/or bordering waters.

BOATING TERMINOLOGY



An easy way to remember PORT side from STARBOARD side is “PORT” and “LEFT” both have four letters.



WARRANTY

TIGÉ LIMITED WARRANTY

SPECIFICATIONS

Model	Length	Beam	Seating	Weight*	Fuel Capacity	Bilge Pump Capacity	Optional Factory Ballast System Capacity**
RZ4	24' (7,3 m)	102" (2,6 m)	17	3,954 lbs (1794 kg)	48 gallons (182 litres)	550 gph (2082 lph)	900 lbs (408 kg)
RZ2	22' (6,7 m)	102" (2,6 m)	14	3,900 lbs (1769 kg)	47 gallons (178 litres)	550 gph (2082 lph)	900 lbs (408 kg)
Z1	21' (6,4 m)	100" (2,5 m)	11	3,750 lbs (1701 kg)	38 gallons (144 litres)	550 gph (2082 lph)	600 lbs (272 kg)
24Vé	24' (7,3 m)	102" (2,6 m)	16	4,230 lbs (1919 kg)	47 gallons (178 litres)	550 gph (2082 lph)	900 lbs (408 kg)
22Vé	22' (6,7 m)	102" (2,6 m)	14	3,850 lbs (1746 kg)	47 gallons (178 litres)	550 gph (2082 lph)	900 lbs (408 kg)
20V	20' (6,1 m)	96" (2,4 m)	9	3,778 lbs (1714 kg)	30 gallons (114 litres)	550 gph (2082 lph)	600 lbs (272 kg)
22i	21' 8" (6,6 m)	102" (2,6 m)	10	3,895 lbs (1767 kg)	47 gallons (178 litres)	550 gph (2082 lph)	600 lbs (272 kg)
20i	20' (6,1 m)	96" (2,4 m)	8	3,468 lbs (1573 kg)	30 gallons (114 litres)	550 gph (2082 lph)	600 lbs (272 kg)

* Weights are estimated and can vary from the options and equipment added.

**Boat load weight MUST BE reduced when using a ballast system. An average boat passenger is defined as 141 lbs (64 kg) per person. The rated boat load must be reduced when the ballast tanks are in use. Reduce passengers and/or equipment by the additional weight of water intended to be taken into the ballast system. Water weighs approximately 8.4 lbs per gallon (1 kg per liter).

The Tigé Limited Warranty includes the exclusive Tigé LifePlus Lifetime Replacement Warranty and the Tigé Three-Year Bow-to-Stern Warranty.

The Tigé LifePlus Lifetime Replacement Warranty is the only replacement warranty in the industry, and it's a bold statement about our faith in Tigé quality and product integrity. The Tigé LifePlus Lifetime Replacement Warranty fully covers the integrated LifePlus Core laminated construction, which includes the hull, stringers and flooring of your new Tigé. If there is ever any structural failure, degradation or delamination for as long as you own your boat, Tigé will replace it with a new boat at no charge.

There has never been a single incident of structural failure in any Tigé hull, floor or stringer component. This is one important reason that Tigé is the only manufacturer that can offer the most solid, far-reaching warranty in the business.

In addition to the LifePlus Lifetime Replacement Warranty, Tigé backs the non-laminated components in our boats with a Three-Year Bow-to-Stern Warranty. This covers upholstery, steering and throttle assemblies, TAPS² and other Tigé-installed components and accessories.

The terms and conditions of the Tigé Limited Warranty are described below.

EFFECTIVE DATE

The warranty period begins on the date the new Tigé boat is delivered to the original retail purchaser or put into use, whichever is earlier.

WHO IS COVERED

The warranty is provided to the original retail purchaser of the new boat. The Tigé LifePlus Lifetime Replacement Warranty is transferable to a second owner under limited circumstances.

PURCHASER'S RESPONSIBILITIES

For this warranty to apply, the purchaser must return the warranty registration card and operate and maintain the boat in accordance with the owner and service manuals.



WARRANTY

TIGÉ LIMITED WARRANTY

TIGÉ LIFEPLUS LIFETIME REPLACEMENT WARRANTY

The exclusive Tigé LifePlus Lifetime Replacement Warranty covers the integrated LifePlus Core construction of the boat, which includes hull, stringers and flooring. The LifePlus Core laminated construction is warranted for as long as the boat is owned by the original retail purchaser. This means that if a structural failure occurs, meaning delamination shown to Tigé's satisfaction, the purchaser will receive a new Tigé boat, provided the conditions contained in this warranty document are met. The LifePlus Lifetime Replacement Warranty does not cover lamination damage caused by hardware or other components fastened or adhered to the hull, stringer, flooring or their respective attachment areas.

The original retail purchaser can transfer the LifePlus Lifetime Replacement Warranty to a documented second owner by submitting an official transfer form and \$500 transfer fee to Tigé. The transfer form must be requested from Tigé and submitted with the fee within twenty days of title transfer.

A transferred warranty provides coverage for ten years after the boat was originally purchased by the first owner. In the event of a structural failure during this ten-year period, the second owner will be entitled to repair at no cost, but will not be entitled to a new boat.

THREE-YEAR BOW-TO-STERN WARRANTY

For a period of three years, Tigé will repair or replace, at its sole option, any defective parts covered by this limited warranty. Repairs and replacements will be warranted for the remainder of the warranty period. For year one of the warranty period, Tigé will pay for both parts and labor. For years two and three, Tigé will pay for parts only. The purchaser is responsible for transporting the Tigé boat or parts to and from the authorized Tigé repair facility. Tigé will complete the repair or replacement within sixty days of receipt of the boat or parts.

ADDITIONAL WARRANTY COVERAGE

Certain items such as carpet, upholstery, gauges and the like may have additional warranty coverage beyond the Three-Year Bow-to-Stern Warranty due to warranties from the original manufacturer of those items.



WARRANTY

TIGÉ LIMITED WARRANTY

EXCLUSIONS

The following are excluded from coverage under this warranty:

- Damage due to misuse, negligence, accident, collision or impact with any object, or owner's failure to perform reasonable and necessary maintenance.
- Damage due to any unauthorized modification, alteration or repair.
- Damage to lamination caused by attachments due to normal wear and usage may be warranted for repair but does not qualify for boat replacement under the Tigé LifePlus Lifetime Replacement Warranty.
- Damage due to weather or natural disaster.
- Paints, varnishes, gel coat colors and surfaces (which may crack or blister with normal use), air voids, finish distortions, chrome plated or anodized finishes, floor covers and other surface coatings, and any other cosmetic items.
- Swim platforms, fiberglass or teak wood.
- Items warranted by another manufacturer (engine, trailers, etc.).
- Boats used for commercial or military purposes, racing, competition, instruction, rental, or performance demonstration.
- Boats used for 40 hours or more for dealer demonstration.
- All components, parts and accessories not supplied or installed by Tigé.
- Performance characteristics such as fuel consumption, speed, etc.

HOW TO OBTAIN SERVICE

Contact your Tigé dealer, or contact the company directly at: Tigé Boats, Inc., 1801 Hwy 36, Abilene, TX 79602, PH: (325) 676-7777, FAX: (325) 677-1135

GENERAL PROVISIONS

Tigé Boats, Inc. reserves the right to modify its products through changes in design or material without being obligated to incorporate such changes in products of prior manufacture.

Tigé does not authorize its dealers or other persons to change the terms of this limited warranty, or to assume any liabilities or repair costs other than those described herein.

Any implied warranties, including merchantability and fitness for a particular purpose, shall not extend beyond the applicable warranty periods described above. Tigé's sole liability with respect to defective parts is as set forth in this warranty, and any claims for incidental or consequential damages are expressly excluded. Some states do not allow limitations on how long an implied warranty lasts or for the exclusion of incidental or consequential damages, so the above limitation or exclusion may not apply to you. This warranty gives you specific legal rights, and you may also have other rights that vary from state to state and outside the United States.

Section 2

SAFETY

SAFETY WHILE BOATING

The popularity of boating and other water sports has undergone an explosion of growth in the past few years. Because of this, safety is an important issue for everyone who shares in the use of our waterways. Boating-related accidents are generally caused by the operator's failure to follow basic safety rules or written precautions. Avoid accidents by becoming completely familiar with your boat, its operation and recognize potentially hazardous situations.

Read and understand this manual and the engine manual. Make sure you understand all controls, features and operating instructions before attempting to operate your boat. Improper operation can be hazardous. Keep control of your boat. Do not operate your boat under the influence of alcohol or other drugs, or if you suspect there is a problem. Always assess the dangers of being in harm's way before the protection of your boat or its equipment. Keep a sound mind during an emergency and always think safety.

In addition to everyday safety, failure to observe the safety recommendations may result in severe personal injury or death to you or to others. Use caution and common sense when operating your boat. Don't take unnecessary chances! Remember that at least three people are needed for safe towing.



Failure to adhere to these warnings may result in severe injury or death to you and/or others.

- **Look before you turn the boat.** As a boater you are obligated to maintain a course and speed unless it is safe to alter course and speed. Look before you turn.
- **Improper operation of the boat is extremely dangerous.** Operators must read and understand all operating manuals supplied with the boat before operation.
- **On-board equipment must always conform to the governing federal, state and local regulations.**
- **Turn the engine off when swimmers or skiers are near the boat.**
- **DO NOT swim in marinas or near boats which are connected to shore power.**
- **DO NOT operate the boat while under the influence of alcohol or other drugs.**
- **DO NOT use the swim platform for any other purpose than boarding the boat or preparation of entering the water, and DO NOT use the swim platform when the engine is running.**
- **DO NOT stand or allow passengers to stand in the boat, or sit on the transom, seat backs, engine cover, sides of the boat or on the closed bow while the engine is running. You or others may be thrown from the boat.**
- **DO NOT overload the open bow area or seat more than three people in the open bow area.**
- **DO NOT exceed 250 lbs (113.4 kg) combined weight of persons and gear in the bow area.**
- **DO NOT allow children under 11 years of age to occupy the open bow area unless accompanied by an adult.**
- **DO NOT allow any type of spark or open flame onboard. It may result in fire or explosion.**
- **DO NOT leave children in the boat without adult supervision.**
- **DO NOT sit in front of the operator to avoid obstructing the operator's view.**

- **DO NOT dive from the boat without being absolutely sure of the depth of the water, otherwise severe injury or death may occur from striking the bottom or submerged objects.**
- **DO NOT swim near the boat when the engine is running. Being in neutral is not enough, the propeller may still be turning and carbon monoxide may be present.**
- **DO NOT replace your boat's marine parts with automotive parts.**
- **DO NOT remove or modify any components of the fuel system except for maintenance by qualified personnel. Tampering with fuel components may cause a hazardous condition.**
- **DO NOT use a tower or extended pylon to pull a wakeboarder or any other watersport activity at speeds above 24 mph (39 kph). Ski pylons and approved towers have been developed for normal water sports activities only. Any other use may cause overstress and result in personal injury or equipment damage.**

GENERAL PRECAUTIONS

Before each outing you should check all safety equipment, such as fire extinguishers, personal flotation devices (PFDs), flares, distress flags, flashlights and the emergency stop switch. They should be operable, in good condition, readily visible and easily accessed.

Tell someone of your travel plans. Check local weather reports before casting off; do not leave the dock area when strong winds and electrical storms are in the area or predicted to be in the area. Know the weight capacity of your boat and DO NOT overload your boat.



SIGNAL WORDS/DEFINITIONS

This section covers general boating safety information. Throughout this manual specific precautions and symbols identify safety-related information.

This is the safety alert symbol. It is used to alert you to potential personal injury hazards. Obey all safety messages that follow this symbol to avoid death or possible injury.



DANGER

DANGER indicates a hazardous situation which, if not avoided, will result in death or serious injury.



WARNING

WARNING indicates a hazardous situation which, if not avoided, could result in death or serious injury.



CAUTION

CAUTION indicates a hazardous situation which, if not avoided, could result in minor or moderate injury.

NOTICE

NOTICE indicates a potentially hazardous situation which, if not avoided, may result in property damage.

The precautions listed in this manual and on your boat are not all-inclusive. If a procedure, method, tool or part is not specifically recommended, you must satisfy yourself it is safe for you and others, and the boat will not be damaged or made unsafe as a result of your decision. REMEMBER, ALWAYS USE COMMON SENSE WHEN OPERATING YOUR BOAT!

REQUIRED SAFETY EQUIPMENT

The Federal Boat Safety Act of 1971 (FBSA/71) established minimum safety standards for boats and associated equipment, specified by the USCG. In addition, the ABYC and the NMMA work with boat builders to develop voluntary standards that exceed base requirements.

Your boat has been equipped at the factory with most federally required Class 1 safety equipment for inland waters.

Many states' equipment requirements go beyond USCG requirements. Contact your state boating office for further information. Equipment requirements for coastal and inland waters differ. Ask your Tigé Dealer or check with local authorities or the USCG for further information about coastal water requirements.

The following equipment may or may not be required by federal/local regulations.

Personal Flotation Devices (PFDs)



WARNING

LIFE SAVING HAZARD

Failure to carry onboard or use life jackets in an emergency can cause death or serious injury. Make sure your boat is equipped with the proper number and type of life jackets.

Federal law also requires at least one Type I, II, III or V Personal Flotation Device (PFD) for each person onboard or being towed, and at least one Type IV throwable PFD in the boat.

PFDs are intended to help save lives. You and your passengers should wear a PFD whenever boating.

All persons should wear a suitable life preserver/PFD when on deck, especially children, disabled people and nonswimmers. Inform all passengers on the proper use of PFDs and of the location of safety equipment, man-overboard recovery equipment and the location and deployment of the ladder. Also, selecting the proper PFD for your type of boating will help ensure your time on the water is the safest possible. There are four types of wearable PFDs and one type used for throwing in emergency situations.

Type I: Most buoyant PFD and effective on all waters, especially open, rough water.

Type II: Good for calm water near shore on most inland waters where quick rescue is likely.

Type III: Good for most inland water applications where quick rescue is likely. Come in various styles and some are designed for watersport activities.

Type IV: Intended for heavy traffic inland waters where help is always available. Designed to be thrown to a person in the water and should never be worn.

Type V: Inflatable design for special use activities and may be used instead of a Type I, II or III PFD if used in accordance with the approval conditions on the label and if worn when the boat is underway. Some Type V PFDs provide increased protection against hypothermia.

If a Type V PFD is to be counted toward the minimum carriage requirements, it must be worn. Special PFDs are available for skiing and other water sports. These PFDs are constructed with materials suitable for high-impact falls.

Keep the following PFD points in mind:

- Set an example and wear your PFD. Require your passengers to wear them also.
- Make sure the PFD fits properly; this is especially important for children and nonswimmers.
- At the beginning of each season, check PFDs for damage and test for proper flotation.

Your Tigé Dealer can help you select appropriate PFDs and throwable lifesaving devices for your area.

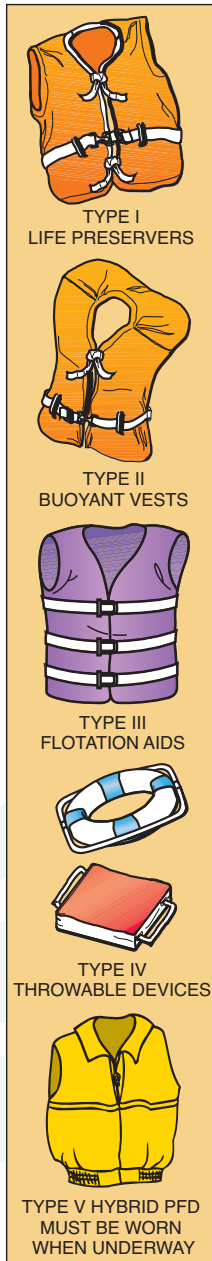

Navigation Lights

All power boats underway between sunset and sunrise must display proper navigation lights. All boats at anchor must display a proper anchor light. The anchor light must be visible 360 degrees. USCG Regulations and International Law require that all craft venturing beyond the “Line of Demarcation” into International Waters, during hours of darkness, must be equipped with proper navigation lighting and the navigation lights must be above the sheer line or rub-rail. Boats with navigation lighting below the sheer line may not operate in International Waters from sundown to sunup.

Horn or Whistle

All boats over 16 ft (4.8 m) in length must be equipped with an operable horn or whistle, audible from one mile.

Fire Extinguisher

All boats between 16 ft and 26 ft (4.8 m and 7.9 m) must carry one Marine Type USCG-approved Type B (gasoline, oil or grease) portable fire extinguisher in operable condition and in an accessible location. Make sure all passengers know the location and operating procedure of each extinguisher.

Check the pressure gauge regularly for proper pressure; have the extinguisher filled if necessary.

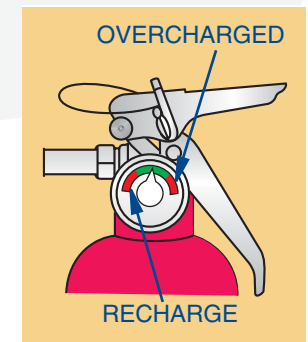



Visual Distress Signals

All boats over 16 ft (4.8 m) must have onboard day and night visual distress signals when operating on coastal waters, the Great Lakes, territorial seas or those waters directly connected to them, up to a point where the body of water is less than two miles wide. Carry several types of signaling devices to handle a variety of conditions. Your dealer can help you select appropriate visual distress signals for your area.

If you are required to carry distress signals, you must have three USCG-approved pyrotechnic devices. Be sure they are in serviceable condition, not exceeding the expiration date and stored in a cool, dry location in a waterproof container. Have enough signals on board to last three days.

WARNING

FIRE/EXPLOSION HAZARD

Pyrotechnic signaling devices can cause fire and/or explosion, death, serious injury and property damage if improperly handled. Follow the manufacturer's directions in the use of handheld signaling devices.

VISUAL DISTRESS SIGNALS

 USE DAY ONLY	 RED DISTRESS FLARE (HAND) USE DAY AND NIGHT	 ELECTRIC DISTRESS LIGHT USE NIGHT ONLY
 ARMS SIGNALS (USE BRIGHT CLOTH) USE DAY ONLY	 DYE MARKER USE DAY ONLY	
	 RED METEOR FLARE USE DAY AND NIGHT	 USE DAY ONLY

Recommended Safety Equipment

As a precaution, a good boater will avoid potential problems on an outing by having additional equipment on board. Normally, this equipment is dependent on the body of water and the length of the trip. Your dealer can assist you.

- First aid kit and manual
- Correct size anchor with at least 75 ft (23 m) of line
- Mooring lines and fenders
- Bailing device (bucket, hand pump, etc.)
- Combination oar/boat hook
- Dock lines and fenders
- Extra engine oil
- Compass
- Day/night distress signals
- Waterproof flashlight and spare batteries
- Cellular phone
- Portable AM/FM radio with weather band
- Lubricant
- Tool kit
- Spare propeller and mounting hardware
- Spare fuses
- Spare key
- Sunglasses and sunblock lotion

SAFETY AND MAINTENANCE

Proper, regular maintenance is mandatory for safe operation of your boat. Make sure all systems are serviced by qualified personnel in accordance with the maintenance schedule.

Before every use, **check** and **tighten** pylons, towers, speakers, add-on accessories and all other hardware.

Your Tigé boat is not like a passenger car which is equipped with shock absorbers and designed for smooth roadways. Boats are subjected to extreme on-water stresses and vibration during normal operation. These stresses can cause mounting hardware to loosen. Regular checking and periodic tightening is necessary to ensure safe operation.

Refer to the **Preflight Checklist** in this manual as a guide to “what to do before every use.” See your Tigé Dealer for regular service and maintenance of engine, transmission and other systems.

EMERGENCY CONSIDERATIONS

Be prepared to deal with emergencies before they happen. Try to formulate a plan for each type of emergency situation in advance so decisions can be made quickly and without hesitation. Precious moments lost can mean the difference between losing and saving a life.

Fire/Explosion

You must be prepared and act quickly when dealing with a fire. It is not recommended to battle a fire for an extended period of time. Turn the engine off and abandon the boat if the fire cannot be extinguished quickly.

Swim at least 75 ft (23 m) upwind from the boat and use the visual distress signals to get assistance.



WARNING

BURN HAZARD

Gasoline floating on water which is ignited can cause death or serious injury. Gasoline will float on top of water and can burn. If the boat is abandoned, swim upwind, far enough to avoid fuel that can spread over the surface of the water.

Onboard fires involving the fuel system usually result in either an explosion that completely destroys the boat, or the boat burning to the waterline and self-extinguishing. Deciding on abandoning the boat or staying to fight the fire is difficult and depends on many factors. Try to formulate a fire plan in advance to make that decision quickly and without hesitation.

Be sure to:

- 🔥 Use caution and DO NOT smoke when refueling.
- 🔥 Make sure fuel is not leaking.
- 🔥 Use only marine-approved equipment on your boat; DO NOT substitute marine components with automotive parts.

Flooding/Swamping

Improper loading, handling, water conditions, weather and anchoring are the most common causes of flooding. Insist on a safe, stable load. DO NOT operate the boat when you experience difficulty maneuvering it. Use extreme caution in hazardous weather and rough water conditions. Anchor from the bow eye when using one anchor.

Collisions/Leaks

If a collision occurs, immediately account for all passengers. Assess the hull for damage and activate the bilge pumps to reduce any water intake. Try to operate the boat to keep the damaged area above water. If necessary, call or signal for assistance.

If a leak is discovered, immediately determine the cause. Verify all drain plugs are installed. Drain plugs should only be removed for removal of excess water and storage, then reinstalled. The continuous operation of the bilge pump, is also an indicator of water leakage. A collision with an underwater object could cause the hull to develop a leak. A loose fitting or hose clamp on a piece of equipment could cause a leak. Try to repair the leak if possible. If a leak is threatening the safety of you and your passengers, call or signal for assistance.

Grounding

In the event you run aground, assess the situation before proceeding. Immediately stop any water from entering the boat. Inspect the steering and control systems, propeller and the hull for damage. Maneuver the boat to safe water only if the hull and all operating systems are in satisfactory operating condition. Otherwise, call or signal for assistance.

Weather/Seas

Getting caught in severe weather is hazardous. Check the weather, sea and wind conditions not only before, but also periodically while you are boating. Refer to **Communication**, in this section, for weather channel information.

Avoid operating your boat in foggy weather. When fog sets in take bearings and log courses and speeds. You are required to emit a five-second blast from your horn or whistle once every minute. Additionally, have passengers wear PFDs and watch for oncoming vessels.

Water Rescue (Man Overboard)

Immediately react to a person who has fallen overboard. Keep the victim constantly in your sight. Safely return to the victim as soon as possible. Throw the person a life preserver. Turn off the engine and help the person into the boat.

Medical Emergency

Be prepared in the event of an emergency. Know how to use your first aid kit. Be aware of any special medical conditions of your passengers.

Drowning

React to a drowning victim in the same manner as described in **Water Rescue**. Handle the victim with care in case of injury. If necessary, resuscitate the victim. Immediately signal for help and keep the victim warm.

Operation Failure

If you experience an engine, steering or control failure, immediately turn off the engine and set the anchor. Try to determine the failure and repair, if possible. Otherwise, call or signal for assistance.

HAZARDOUS CONDITIONS

Every waterway poses hazards that you should avoid: shallow water, tree stumps, sand bars, etc. Ask local boaters for information and consult a marine chart when boating on unfamiliar waters. As the operator of the boat, you should try to avoid all hazards, known and unknown. The following information does not contain all possible water hazards.

Weather

Getting caught in severe weather is hazardous. Check with local weather stations, the USCG, or weather service broadcasts (162.55 or 162.40 Megahertz) for the latest conditions. It is recommended to check the weather not only before, but also periodically while you are boating.

Storms – Take common sense precautions if you are forced to operate your boat in stormy conditions:

- Wear PFDs.
- Stow gear below and lash equipment on deck.
- Reduce speed and head for a place of refuge you can reach most easily.
- If you lose power, keep boat headed into the waves by rigging a sea anchor off the bow eye.

Fog – It is best to avoid operating your boat in foggy weather. When fog sets in take bearings and log courses and speeds. You are required to emit a five-second blast from your horn or whistle once every minute.

Additionally, have passengers wear PFDs and observe for oncoming vessels.

Dam Spillways

The water around a dam spillway is a hazardous area. It is subject to rapid changes. Keep clear of the spillway areas below dams.

Shallow Water Operation

Operating in shallow water presents a number of hazards. If the engine strikes an underwater hazard, check for boat and engine damage. If the engine vibrates excessively after striking an underwater obstruction, it may indicate a damaged propeller or shaft.

Sand bars in narrow inlets are constantly shifting, making it difficult to mark them with buoys. Sometimes sand bars are indicated by waves as they form into breakers when passing over the sand bar. If you ground the boat on a sand bar, seek help from another boater or radio for help.

In coastal areas, tides can affect water level as much as 30 ft (9 m). Check with local marinas or Coast Guard stations for tide tables and current charts.

Visibility



WARNING

Obstructed visibility can cause death or serious injury. Maintain clear visibility at all times. Arrange passengers and equipment for maximum visibility or designate a passenger to assist when visibility is limited.

Visibility is not only sight, but also hearing. It is very important for the operator to maintain good visibility at all times. Arrange passengers and equipment to ensure you have unobstructed vision at all times. Check for other boats or any obstacles before turning the boat.

BOATING UNDER THE INFLUENCE

Do not operate the boat while under the influence of drugs or alcohol. The combination of noise and vibration, sun, wind and motion all combine to produce fatigue on the water. The effects of alcohol are greater on the water than on land. Drugs and boating do not mix. Operating any boat while intoxicated or under the influence of other drugs is both dangerous and illegal. Impaired vision or judgment on the water can quickly lead to disaster. As the owner/operator, you are responsible for the alcohol/drug use and onboard behavior of your passengers.



WARNING

IMPAIRED OPERATION HAZARD

Operating any craft while intoxicated or under the influence of other drugs can cause death or serious injury. DO NOT operate any craft under the influence of any mind-altering chemical.

SKILL/EXPERIENCE

There is no replacement for skill and experience when operating a boat. If this is your first boat, ask an experienced boater or your Tigé Dealer. Learn to operate your boat in calm water. Avoid windy conditions and rough water and make sure visibility is good at all times. DO NOT practice close to any obstructions such as buoys, piers, bridges, moored boats, high traffic or swim areas. Start off slow and give yourself plenty of time and room to react. A boat is not an automobile. It requires additional time to maneuver and stop.

CARBON MONOXIDE



DANGER

Exposure to carbon monoxide will cause death or serious injury. DO NOT use the swim/boarding platform for any other purpose than boarding the craft or preparation of entering the water, and DO NOT use the swim/boarding platform when the engine is running.

Carbon Monoxide (CO) is a colorless, odorless and dangerous gas produced by all engines and fuel-burning appliances. Even with the best boat design and construction, plus the utmost care in inspection, operation and maintenance, hazardous levels of CO may still be present in occupied spaces under certain conditions.

Direct and prolonged exposure to CO will cause brain damage or death. Signs of exposure to CO include nausea, dizziness and drowsiness. Avoid exposure to yourself and/or your passengers to CO.

Have a suspected CO victim deeply breathe fresh air and immediately seek medical attention.

OPERATION BY MINORS

Minors must be supervised by an adult whenever operating a boat. Many states have laws regarding the minimum age and licensing requirements of minors. Be sure to contact the state boating authorities for information.

COMMUNICATION

Radio communication is the most important avenue of receiving weather reports and Coast Guard warnings, and sending information such as transmitting request for assistance. Use a VHF/FM radio for short-range communication, and a single-side band radio (SSB) for long-range.

For all U.S. waters, the National Weather Service operates the NOAA Weather Radio (NWR). This service provides continuous weather information on the following VHF/FM frequencies:

- 🚩 162.400 MHz • 162.500 MHz
- 🚩 162.425 MHz • 162.525 MHz
- 🚩 162.450 MHz • 162.550 MHz
- 🚩 162.475 MHz

Coast Guard Marine Information Stations

- 🚩 2670.0 kHz • 8765 kHz
- 🚩 4428.7 kHz • 13113.2 kHz
- 🚩 6506.4 kHz

It is good practice to periodically monitor the weather.

Cellular Telephone

A cellular phone can be extremely convenient for ship-to-shore communications. Cellular telephone service continues to improve by expanding service areas and advancing technology.

Seek the latest available information regarding network providers and coverage in your boating area before purchasing cellular telephone service.

WATER SPORT AND TOWING SAFETY

Boat operators, skiers and boarders must all be aware of current boating and water sport rules and pay constant attention to safe operating procedures and skiing practices at all times. If skiing or boarding is a new sport, seek certified training before starting. You will find it especially helpful to join a local ski club, World Wakeboard Association and/or the USA Water Ski, when possible.

Always remember that the majority of water skiing injuries are the result of impacts with other objects. Know the area you are skiing in.

Always look where you are going and be aware of what is going on around you.

Skiers, boarders and other water sports enthusiasts must always wear a USCG-approved PFD. It's the law!

Tigé Boats, Inc. and your dealer will not assume responsibility for damage or personal injury that may occur from the use of a boom or extended pylon on a Tigé boat. The transom towing hook is designed for normal water sports activities only.

The following guidelines will help you stay safe, avoid accidents and have a fun time on the water.



Teak/Drag Surfing

Read, understand and be familiar with the information contained on warning labels and adhere to the boat operation practices described on them. The USCG issued a SAFETY ALERT on August 28, 2001 that covers some of the issues of improper use of the boarding platform. The SAFETY ALERT and portions of the accompanying information follow:

Every year tragic deaths occur from the negligence of unsafe boating and dangerous activities. Experts say, “many of these deaths may have been caused by an invisible hazard, carbon monoxide poisoning.” Taking the risk of swimming under a boarding platform when the engine is running, skiing within 20 ft (6.1 m), “teak surfing” or “dragging” behind a moving boat can be fatal.

No boating manufacturers consider dangerous activities which can result in a death or serious injury a water sport. Boating manufacturers are concerned for the safety of all boaters and Do not promote unsafe boating risks or jeopardizing any boaters’ safety, in a boat or in the water.

Do not use the swim/boarding platform for any other purpose than boarding the boat or preparation of entering the water, and DO NOT use the swim/boarding platform when the engine is running.

SAFETY ALERT From August 28, 2001:

The United States Coast Guard advised boaters not to “Teak/Drag Surf.” Recent boating fatalities revealed that carbon monoxide (CO) emitted from a vessel’s exhaust resulted in CO poisoning and the death of at least six teak surfers. “Teak/Drag Surfing” places the individual in position directly exposed to the CO in the engine’s exhaust. This may result in a loss of coherent responses and even death. In addition, “Teak/Drag Surfing” dangerously exposes the individual to a possible propeller injury, and since it is done without a life jacket (PFD), it significantly increases the probability of drowning. Therefore, the Coast Guard stresses, “Teak/Drag Surfing” is a very dangerous activity and advises boaters not to participate in it.

The Coast Guard pointed out that carbon monoxide is one of the most dangerous gases. It strikes before you know you are exposed and it impairs in a way that can and too often does lead to death.

That is why it is so important to the Coast Guard that in every circumstance where it can be avoided, it is.

General Water Sport Precautions

- **DO NOT** participate in water sports in shallow water, close to shore or in water where you do not know the depth or what is beneath the surface.
- **DO NOT** put your arm, head or any other part of your body through any part of the tow lines or wrap a line around any part of the body at any time.
- **DO NOT** participate in water sports at night or directly in front of other boats.
- **DO NOT** jump from a boat that is moving at any speed, and do not enter or exit the water when the engine is running.
- **DO NOT** approach the boat if the engine is running.
- **DO NOT** participate in water sports near swimming areas, beaches, other boats or personal watercraft.
- **DO NOT** follow directly behind another boat or other water sport participants without leaving an adequate safe distance.
- **DO NOT** “back up” to anyone in the water.
- **DO NOT** participate in water sports with multiple skiers with different length ropes.
- **DO NOT** participate in water sports in limited visibility conditions.
- **DO NOT** approach the rear of the boat while the engine is running.
- **DO NOT** use the water sport tow points for anything other than “towable” water sports.
- **DO NOT** kitefly.
- **DO NOT** sit behind the tow pylon during water sports activities.
- **Operate blower while at slow speeds.**
- **Make sure that everyone knows and uses approved water sport hand signals and common water sport courtesies.**
- **Make sure to turn off the engine before allowing anyone to approach the boat.**
- **The engine must be shut down before any water sport participant enters or exits the boat, swim platform or ladder.**
- **Every water sport participant must always wear a USCG-approved Type III PFD. Special PFDs are available for high-impact falls into the water.**
- **Maintain a distance of at least 100 feet from all other objects, including other boats, piers, rafts, mooring and navigational buoys, pilings, abutments or any other items.**
- **Make sure to have an experienced operator and observer in the boat when skiing.**
- **Look before you turn the boat to pick up a fallen water sport participant.**
- **Have ship-to-shore communication devices and a compass on board if operating at a significant distance offshore.**

- The operator should never retrieve or pick up an article from the water while the engine is running. The engine must be shut off.
- The operator should always keep the water sport participant in view when the participant is entering or exiting the boat.
- Communicate towing speed with the participant before starting.
- The operator should know the ability level of the water sport participant.
- The participant should indicate he/she is clear of the boat prior to starting the boat or putting the boat into gear and tightening the tow line.
- The operator, observer and participant should agree to communication hand signals before starting.
- An observer in the boat should keep the operator aware of participants' status.
- The operator should always watch the participant as the tow line is tightened to start.
- The operator should be aware of path before starting.
- The operator should start from a safe place with good forward and peripheral visibility.
- The operator should be primarily aware of what is occurring in front of the boat, but aware of the participant's progress.
- Be sure to inspect the tow eye or water sports tow point before use. If there is any evidence of wear or other damage, **DO NOT** use until it has been inspected by your dealer.
- Be sure to wear wet suits or protective shorts when skiing to prevent abrasions, hypothermia and injuries to orifices (rectal and vaginal) from impact with a water surface.
- When people are getting on or off of water sports equipment, always turn the engine off. If boarding water sports equipment from the boat, always use the swim platform.
- Always inspect water sports equipment for wear, fraying, etc., before use. **DO NOT** use if they show signs of wear or fraying. Replace the equipment if they show signs of wear. **DO NOT** wait for the equipment to break before replacing it and **DO NOT** use old parts.
- When approaching a water sport participant, always turn the engine off before allowing the participant to come onboard.
- Be sure to approach a downed participant on the operator's side and always keep them in view.
- Display a "skier down" flag whenever the participant is in the water and not skiing.
- Be sure to follow the approved towing pattern on each lake.

When participating in water sports, be safe and courteous and follow these guidelines:

- Be considerate to fishermen and others on the water.
- **DO NOT** perform water sports in congested areas.
- Stay away from navigation markers.
- Stay away from other boats and water sports participants.

Water Sports Responsibility Code

Be aware that there are elements of risk in boating, skiing and riding that common sense and personal awareness can help reduce.

Know your limitations and ability level and stay within them.

To increase your enjoyment of water sports, follow the "Water sports Responsibility Code."

It is your responsibility to:

- Familiarize yourself with all applicable laws, the risks inherent in the sport and the proper use of equipment.
- Know the waterways where you will be participating in water sports or riding.
- **DO NOT** ski or ride in shallow water or near shore, docks, pilings, swimmers or other watercraft.
- Always have a person of the appropriate age and capable, other than the boat driver, as an observer and agree on hand signals before starting.
- Always wear a USCG type III (PFD) vest.
- Finish reading this owner's manual and any equipment manual and inspect your equipment prior to use.
- Ski or ride within your limits.
- Always ski or ride in control and at speeds appropriate for your ability.
- Always turn ignition off when anyone is near watercraft power drive unit.
- Avoid exposure to CO poisoning!
- Never drag within 20 ft (6.1 m) behind a moving watercraft.
- **DO NOT** operate watercraft, ski or ride under the influence of alcohol or drugs.



Section 3

BASIC RULES OF THE ROAD



WARNING

COLLISION HAZARD

Collisions between boats can cause death or serious injury. Follow the nautical "Rules of the Road."

The operator is legally required to follow the rules. The following information outlines only the most basic of the nautical "Rules of the Road." For more information, contact your local USCG Auxiliary.

TRAILER SAFETY

Before trailering:

- Check trailer ball for tightness.
- Connect trailer hitch only to the ball size marked on coupling.
- Make sure the hitch ball is fully engaged in coupler and locking lever is down. Never place hands or other body parts between the coupling and any part of the tow vehicle.
- Connect safety chains under coupling, allowing only enough slack in chains for turns.
- Lock winch and attach safety straps and chains. Never tow your boat/trailer unless the safety straps and chains are attached and the winch is in the locked position.
- Check trailer wheel lug nuts are tightened 90-95 ft-lbs (122-129 N·m) of torque.
- Check tire pressure in accordance with the tire pressure on the tire.
- Make sure all lights are working properly.
- Make sure "bearing buddies" are greased.

AIDS TO NAVIGATION

Learn to recognize the different buoys and day markers; they are the signposts of the waterways. There are two primary marking systems in use in the U.S.: the Uniform State Waterway Marking System (USWMS), used on inland waters and maintained by each state, and the Federal Waterway Marking System (FWMS), used on coastal waters and rivers and maintained by the USCG. In addition, the FWMS has two modified systems: the Western River Buoyage, and the Intercoastal Waterway Buoyage. Be sure to check with local authorities on the buoyage system in use.

The type of hazard/warning buoys and markers depends on the area of jurisdiction. Check with local boating authorities.

The only buoys you are permitted to moor to are mooring buoys.

Mooring to a navigation buoy or other navigational aid or regulatory marker is illegal.

Types of Buoys

There are several types and shapes of buoys. Buoys may be unlighted, lighted, with sound or may have an audible and a visual signal. Lights, bells and horns are used on buoys for night or poor visibility conditions. Buoys with unique light flashing characteristics are identified on nautical charts with the specific flashing pattern.



UNLIGHTED
BELL BUOY



SPAR BUOY

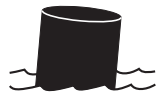

CAN BUOY



LIGHTED BUOY



NUN BUOY



SPHERICAL SAFE
WATER MARKER

Mooring Buoys

The only buoys you are permitted to moor to are mooring buoys. Mooring buoys are white with a blue horizontal stripe. Mooring to a navigation buoy, regulatory markers or lateral markers is illegal.

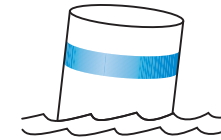

Regulatory Markers

Regulatory markers indicate dangerous or restricted controlled areas. These markers are used to indicate speed zones, areas set aside for particular use, general information and directions.

Regulatory markers are white with orange geometric shapes and also have orange bands near the top and at the waterline of the buoy. You must obey regulatory markers.



CONTROLLED
AREA



DANGER



BOATS
KEEP OUT



INFORMATION

Lateral Markers







Lateral markers are oriented from the perspective of being entered from seaward (the boater is going toward the port). This means that red buoys are passed on the starboard (right) side of the vessel when proceeding from open water into port, and green buoys to the port (left) side.

The right side (starboard) of the channel is marked with RED, even-numbered buoys. The left side (port) of the channel is marked with GREEN, odd-numbered buoys.

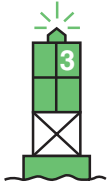
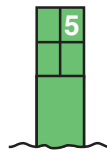
Day markers are colored and numbered the same as buoys. RED, triangular day markers with even numbers mark the starboard side of the channel.

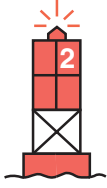
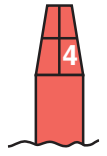
GREEN, square day markers with odd numbers mark the port side of the channel.

Fairways and mid-channels may be marked with safe water marks or buoys. These marks indicate safe water all around. Safe water marks are red and white striped and are round or have a red spherical topmark.

Lateral Aids Marking the Sides of Channels as seen When Entering From Seaward	<div style="border: 1px solid black; padding: 5px; margin-bottom: 10px;"> ■ GREEN LIGHT ONLY Flashing (2) Quick Flashing Flashing Iso Occulting </div> <div style="display: flex; justify-content: space-around; align-items: center;"> <div style="text-align: center;">  Lighted Buoy </div> <div style="text-align: center;">  Can Buoy </div> <div style="text-align: center;">  Daymark </div> </div>
	<div style="border: 1px solid black; padding: 5px; margin-bottom: 10px;"> ■ RED LIGHT ONLY Flashing (2) Quick Flashing Flashing Iso Occulting </div> <div style="display: flex; justify-content: space-around; align-items: center;"> <div style="text-align: center;">  Lighted Buoy </div> <div style="text-align: center;">  Nun Buoy </div> <div style="text-align: center;">  Daymark </div> </div>
Safe Water Aids Marking Mid-Channels and Fairways (No Numbers—May be Lettered)	<div style="border: 1px solid black; padding: 5px; margin-bottom: 10px;"> <input type="checkbox"/> WHITE LIGHT ONLY MORSE CODE Mo (A) </div> <div style="display: flex; justify-content: space-around; align-items: center;"> <div style="text-align: center;">  Lighted </div> <div style="text-align: center;">  Spherical Buoy </div> <div style="text-align: center;">  Daymark </div> </div>

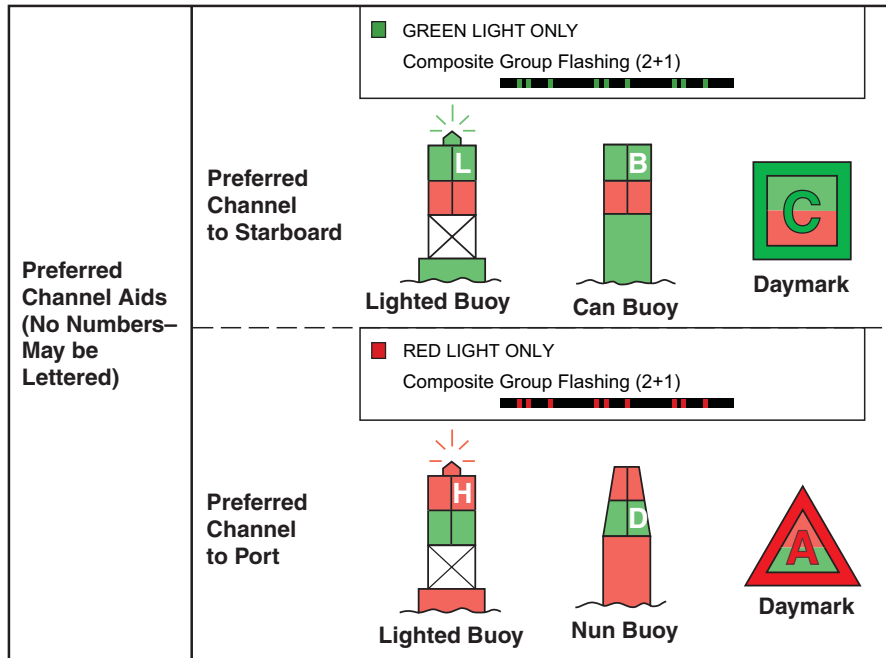

Obstructions, channel junctions, etc. are marked with RED and GREEN horizontally striped buoys.

A RED band at the top means the preferred channel is to the left of the buoy; a GREEN top band means the preferred channel is to the right of the buoy.

Isolated Danger Markers

Isolated danger markers indicate an isolated danger which may be passed on all sides. These markers are colored black with one or more broad horizontal red bands and are equipped with a topmark of two black spheres, one above the other.

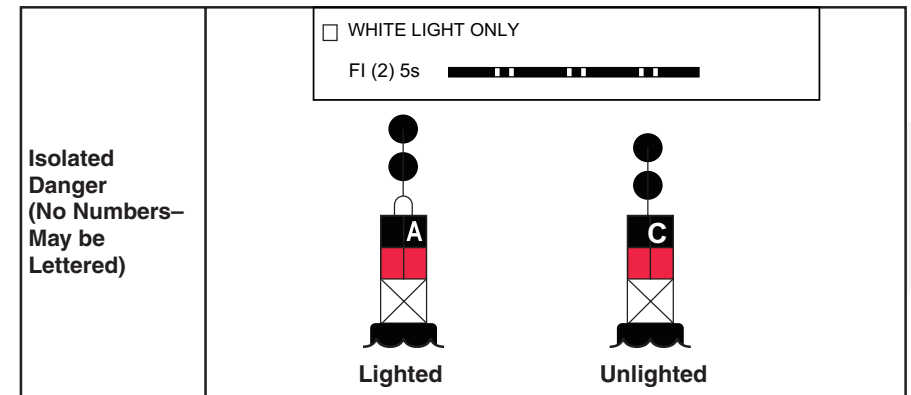

On inland waters, a buoy with alternating vertical black and white stripes may be used to indicate that an obstruction or other danger exists between the buoy and the nearest shore. DO NOT pass between the buoy and the shore.



BLACK-STRIPED
WHITE BUOY

Warning Markers

It is a good idea to ask local authorities if there are hazardous areas and how they are marked.

Boaters must also recognize the flag designs which indicate that skin divers are present and keep well clear of the area.

DIVERS FLAG

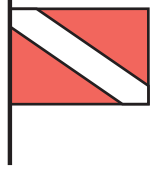

USED BY RECREATIONAL DIVERS - INDICATES DIVER'S POSITION

ALPHA FLAG

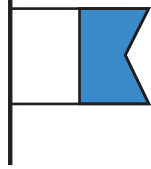

WORLDWIDE VESSELS ENGAGED IN DIVING OPERATIONS - DOES NOT INDICATE DIVER'S POSITION

DISTRESS FLAG



INDICATES FELLOW BOATER IS IN NEED OF ASSISTANCE

Watch for swimmers. Swimming areas may not be marked. Steer clear from the area and remain alert.



Right-of-Way

NOTICE

In general, boats with less maneuverability have right-of-way over more agile craft. You must stay clear of the vessel with right-of-way and pass to his stern.

Whistle/Horn Signals

Signaling other boats with a whistle or horn is similar to using turn signals on an automobile. It is not necessary to sound a signal every time a boat is nearby. In general, boat operators should signal their intention to avoid potentially confusing or hazardous situations.

It is customary for the privileged boat to signal first, and the give-way boat is to return the same signal to acknowledge she understands and will comply.

Use the danger signal (five or more short and rapid blasts) if intent is not clear.

Use the following signal blasts early enough to be noticed and understood by other boaters:

- One long blast: Warning signal (coming out of a slip or passing astern)
- One short blast: Pass on my port side
- Two short blasts: Pass on my starboard side
- Three short blasts: Engines in reverse
- Five or more short and rapid blasts: Danger Signal!

Privileged Boats

Privileged boats have right-of-way and can hold course and speed.

Sailboats and boats paddled or rowed have the right-of-way over motor boats. Sailboats under power are considered motorboats.

Small pleasure craft must yield to large commercial boats in narrow channels.

Burdened Boats

The burdened boat is the boat that must make whatever adjustment to course and speed necessary to keep out of the way of the privileged boat.

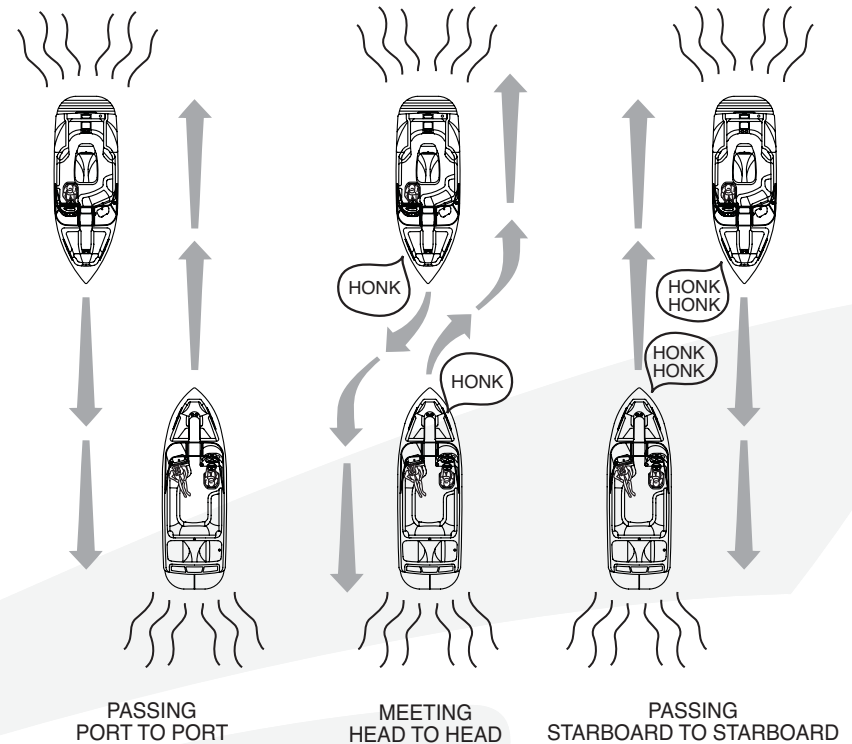

Crossing Situation

In crossing situations, the boat to the right from the 12 o'clock to the 4 o'clock position has the right-of-way. It must hold course and speed. The burdened boat keeps clear and passes behind the privileged boat. Boats going up and down a river have the privilege over boats crossing the river.

Meeting Head-On

Neither boat has the right of way in this situation. Both boats should decrease speed, turn to the right and pass port to port. If both boats are on the left side of the channel, each vessel should sound two short blasts and pass starboard to starboard.

Overtaking

The boat that is overtaking one ahead of it is the give-way boat and must make any adjustments necessary to keep out of the way of the stand-on boat. The stand-on boat should hold its course and speed.

The General Prudential Rule

The General Prudential Rule regarding right-of-way, is that if a collision appears unavoidable, neither boat has right-of-way. As prescribed in the “Rules of the Road,” both boats must act to avoid collision.

Night Running

Boats operating between sunset and sunrise (hours vary by state) must use navigational lights. Nighttime operation, especially during bad weather or fog, can be dangerous. All “Rules of the Road” apply at night, but it is best to slow down and stay clear of all boats, regardless of who has right-of-way.

Protect your night vision by avoiding bright lights and have a passenger, if possible, keep watch for other boats, water hazards and aids to navigation.

The size, speed and direction of other vessels are determined at night from the running lights. A green light indicates the starboard side of the boat, and a red light indicates the port side. Generally, if you see a green light, you have right-of-way; if you see a red light, give way to vessel. Refer to **REQUIRED SAFETY EQUIPMENT, Navigation Lights**, to be sure you are operating legally in certain areas.

Section 4

FEATURES

GENERAL LAYOUTS

The General Layout illustrations show two models to represent a V-drive and a direct drive. All of these components or accessories may not be included on your Tigé boat.

FEATURES

Typical V-drive Layout



RZ2 Shown

1. Bow Eye/Anchor Point
2. Bilge Area Vents
3. Storage
4. Cockpit Seat Adjustment
5. Cooler
6. Swivel Board Racks
7. Cockpit Entrance Tread
8. Fuel Fill
9. Water Sports Tow Pylon
10. Transom Cooler/Transom Shower – Optional
11. Stern Eyes
12. Swim Platform/Boarding Platform
13. Motor Box/Bilge Area
14. Storage/Battery Access
15. V-drive Transmission
16. Cockpit Entrance Tread/Cockpit Table Mount – Optional
17. Dash Storage/Glove Box

Typical Direct Drive Layout

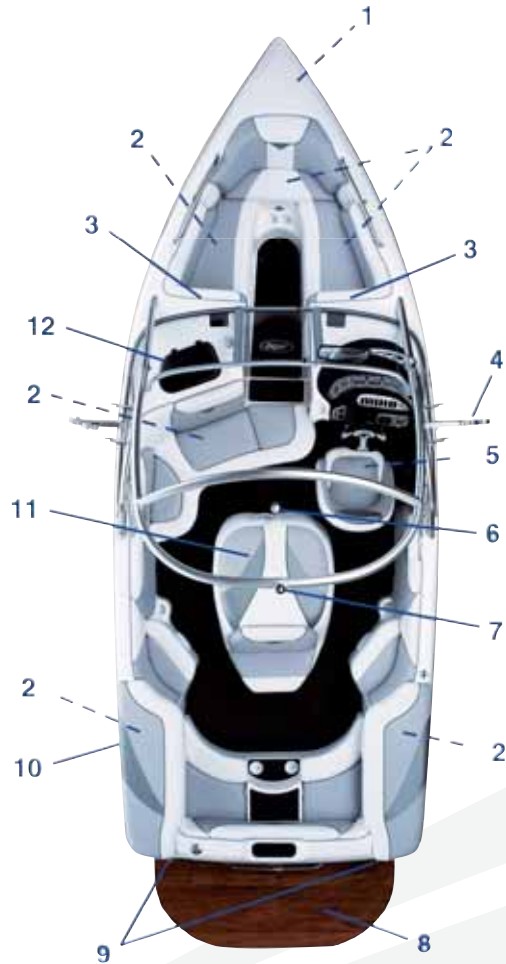

22i Shown

1. Bow Eye/Anchor Point
2. Storage
3. Bilge Area Vents
4. Swivel Board Racks
5. Cockpit Seat Adjustment
6. Water Sports Tow Pylon
7. Tower Water Sports Tow Pylon – optional
8. Swim Platform/Boarding Platform
9. Stern Eyes
10. Fuel Fill
11. Motor Box/Bilge Area/I-drive Transmission
12. Dash Storage/Glove Box

DASH PANELS

The Dash Panel illustrations are used to help you identify the location of switches, controls, ports, gauges and V-drive indicator. Your boat may not be equipped with all of the features or options.

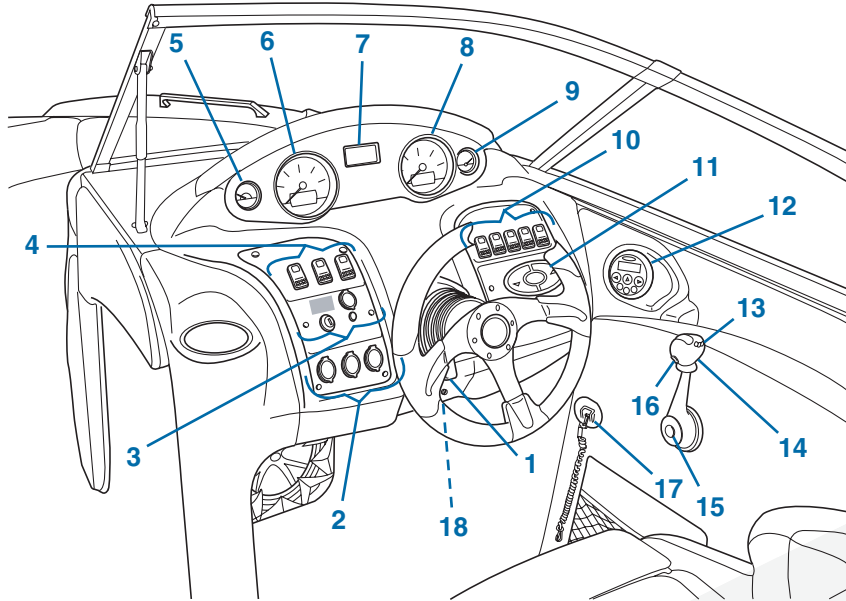

RZ4, RZ2, 24Vé, 22Vé



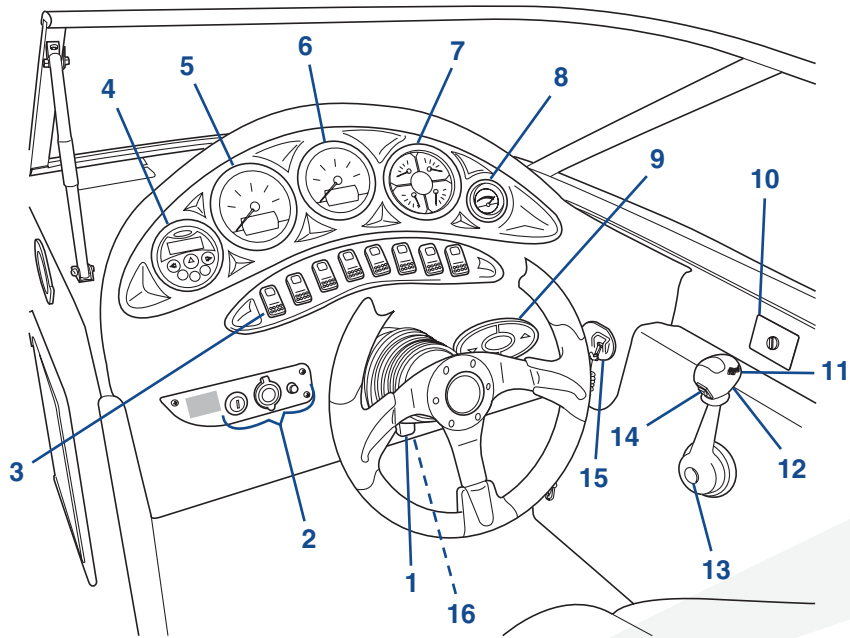

1. Steering Tilt Lever
2. 12-Volt Ports
3. Ignition Key Switch, iPod™/MP3 Port – Optional, Horn
4. NAV ANCH (Navigation Lights), BLOWER (Engine Compartment /Bilge Area Blower), BILGE (Bilge Pump)
5. Fuel Gauge
6. Tachometer
7. Digital Depth Finder / Air/Water Temperature Display
8. Speedometer/Multifunction LED Display
9. TAPS² Gauge
10. CTSY LTS (Courtesy Lights), ACC (Accessory), DOCK LTS (Docking Lights, Optional), FWD TOWER AFT (Tower Lights), CRUISE CONTROL ON/OFF – Optional (Tigé SpeedSet)
11. Tigé SPEEDSET Control Panel – Optional
12. Stereo Remote – Optional
13. Shifter/Throttle Control Handle
14. Safety Lockout Ring (Shift Lockout)
15. Neutral Throttle Button
16. TAPS² Rocker Switch
17. Emergency Stop Switch
18. Circuit Breaker Panel

Ballast Tank Control Switches – Optional, not shown

Heater (Heater Fan Control Switch for the optional cockpit heater), not shown



Z1, 22i, 20V, 20i

1. Steering Tilt Lever
2. 12-Volt Ports
3. CTSY LTS (Courtesy Lights), ACC (Accessory), DOCK LTS (Docking Lights, Optional), FWD TOWER AFT (Tower Lights), CRUISE CONTROL ON/OFF (Tigé SpeedSet)
4. Stereo Remote – Optional
5. Fuel Gauge
6. Tachometer
7. Tigé Multifunction Gauge
 -  fuel (Fuel Level)
 -  volt (Voltmeter)
 -  temp (Engine Temperature)
 -  oil (Engine Oil Pressure)
8. TAPS² Gauge
9. Tigé SPEEDSET Control Panel – Optional
10. Heater (Heater Fan Control Switch for the optional cockpit heater), not shown
11. Shifter/Throttle Control Handle
12. Safety Lockout Ring (Shift Lockout)
13. Neutral Throttle Button
14. TAPS² Rocker Switch
15. Emergency Stop Switch
16. Circuit Breaker Panel

Ballast Tank Control Switches – Optional, not shown



SWITCHES, CONTROLS, PORTS, GAUGES and INDICATORS

Switches

The switches are fitted with LEDs, which will illuminate when power is being supplied to the corresponding switch and its function. The switches and components are protected by circuit breakers. If the component does not function or switch does not illuminate, check the circuit breaker panel located under the dash. Refer to **Circuit Breaker Panel**.

ACC (Accessory)

This switch is reserved to operate a switched accessory item. When the switch is pressed, the accessory will receive power; when the opposite end is pressed, the power will turn off.

NOTICE

DO NOT connect an accessory drawing more than 10 amps to the accessory switch. A hazardous situation or damage to the electrical system can occur.

Ballast Tank Control Switches – Optional

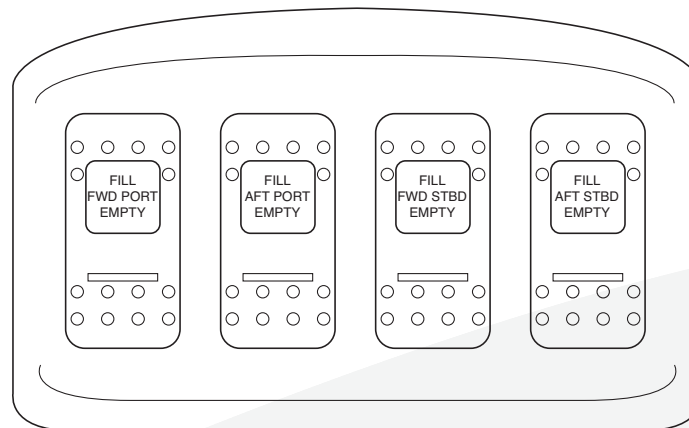

Boat load weight must be reduced when using a ballast system. An average boat passenger is defined as 141 lbs (64 kg) per person. Water weighs approximately 8.4 lbs per gallon (1 kg per liter).

If the boat is equipped with a ballast system, the rated boat load must be reduced when the ballast tanks are in use. Reduce passengers and/or equipment by the additional weight of water intended to be taken into the ballast system.

These switches are three-position switches to fill or drain the ballast tanks. When the top of the switch is pressed, pump will begin to fill the designated tank. When the opposite end of the switch is pressed, the pump will begin to empty the designated tank.

If you continue to fill the tank beyond its capacity, the excess water will expel from the tank vent. The pump will continue to operate until the switch is returned to the OFF (center) position. The LED will illuminate anytime the pump is on. Make sure to return the switch to the OFF position when the tank is filled or emptied.



BILGE (Bilge Pump)

This switch operates the bilge pump to remove excess water from the bilge area of the boat manually. When the top of the switch is pressed, the bilge will turn on. When the bottom is pressed, the bilge will turn off.

Your Tigé boat is equipped with an automatic bilge pump which detects excess water accumulation and will turn the bilge pump on automatically. The switch does not have to be on for the automatic system to work. This switch can also be used to test the bilge pump, by listening to hear that the pump is operating. It may not pump water unless water is present. Do not operate the bilge pump continuously when it is dry.

Inspect the bilge area frequently for evidence of excessive water. Continuous operation of the bilge pump can mean there is excess water in the bilge. Test the bilge pump at regular intervals. Debris can also prevent the pump from operating or make it operate continuously. Make sure no debris is blocking the bilge pump float. See your Tigé Dealer if you have any questions.

BLOWER (Engine Compartment/Bilge Area Blower)

This switch operates the engine compartment ventilation blower to remove explosive fumes from the area. When the switch is pressed, the blower will turn on. When the opposite end is pressed, the blower will turn off. The blower must be operated for a minimum of four minutes before starting the engine. Also, the blower should be operated continuously when at idle or running at slow speeds.



WARNING

FIRE/EXPLOSION HAZARD

Gasoline vapors are highly explosive when exposed to open flame or spark resulting in death or serious injury. Run blower for at least four minutes BEFORE turning on any electrical devices or starting the engine.

CRUISE CONTROL ON/OFF (Tigé SpeedSet)

This switch supplies power to operate the Tigé SpeedSet. When the switch is pressed (on), power is supplied for the cruise control, when the opposite end is pressed, the power will turn off.

CTSY LTS (Courtesy Lights)

This switch operates the courtesy lights. When the switch is pressed, the lights will turn on. When the opposite end is pressed, the lights will turn off.

DOCK LTS (Docking Lights, optional)

This switch operates the docking lights. The docking lights are to be used for docking only; DO NOT use them while cruising. When the switch is pressed, the lights will turn on. When the opposite end is pressed, the lights will turn off.

Emergency Stop Switch



WARNING

LOSS OF CONTROL AND UNSAFE BOAT HAZARD

An emergency stop switch system that is not used or does not function properly can cause death or serious injury. DO NOT operate the boat if the emergency stop switch system does not function properly.

The emergency stop switch will stop the engine when the lanyard is pulled far enough to disconnect the clip from the switch. Attach the lanyard to the boat operator whenever the engine is running, but be aware of loss of engine power if the switch is activated.

If the operator is thrown from the seat, or moves too far from the dash, the lanyard will disconnect the clip from the switch, shutting off the engine.

To attach a lanyard, connect the clip to the emergency stop switch and the hook to a strong piece of clothing on the operator, such as a belt loop.

IMPORTANT

The engine will not start unless the clip is attached to the emergency stop switch.

The emergency stop switch can only be effective when it is in good working condition.

Observe the following:

- DO NOT remove or modify an emergency stop switch and/or its lanyard.
- Keep the lanyard free from obstructions that could interfere with its operation.

Check the emergency stop switch once a month for proper operation. With the engine running, pull lanyard to pull the clip from the switch. If the engine does not stop, see your Tigé Dealer for service immediately.

FWD TOWER AFT (Tower Lights)

This switch is a three-position switch to operate the tower lights. Push FWD to operate the forward lights or AFT to operate the aft lights. DO NOT use them while cruising. The center position of the switch is off for all lights.

Horn

The “HORN” button is a momentary switch. The horn will operate when the button is pressed and stop when the button is released.

Ignition Key Switch

This key switch starts and stops the engine. A built-in protection system prevents the engine from starting in any gear and only in NEUTRAL. Refer to **Shifter/Throttle Control** in this section and refer to the engine owner’s manual for more information.

There is an accessory position on the ignition key switch. A terminal on the back of the switch is provided to control power to add-on accessories. Even though power to this terminal is protected by a 20-amp fuse, do not connect any accessory that draws more than 10 amps. Attaching an accessory to this terminal should only be done by a qualified technician.

NOTICE

DO NOT connect an accessory drawing more than 10 amps to the key switch accessory terminal. A hazardous situation or damage to the electrical system can occur.

NAV ANCH (Navigation Lights)

This switch is a three-position switch to operate the navigation lights. The law requires the bow light and the 360 degree light (anchor) be turned on while running the boat after sunset or before dawn. When the top of the switch is pressed, the navigation lights will turn on (the red, green and anchor).

When the opposite end of the switch is pressed, the anchor light only will turn on, for mooring. This light is required by law to be on after sunset and before dawn when the boat is not moving. The center position of the switch is off for all lights.

Insert the anchor light pole into the receptacle located near the stern and push the anchor switch on. Refer to **SAFETY, Navigation Lights** for detailed information on operating your boat after sunset and before dawn.

CONTROLS

Shifter/Throttle Control



WARNING

COLLISION HAZARD

An overspeeding engine, from loss of throttle control, can cause collision resulting in death or serious injury. Make sure all control systems are regularly inspected and properly maintained.

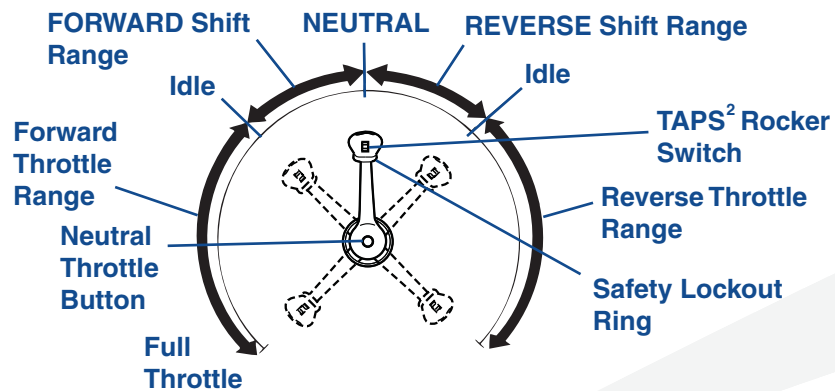

This single-lever control operates both the gearshift and throttle. The control can only be moved from the neutral position by lifting the safety ring under the throttle handle. Moving the control forward from the NEUTRAL position will advance the throttle FORWARD. Moving the control aft from the neutral position will advance the throttle REVERSE.

To “rev” the engine without engaging the transmission from NEUTRAL, push in the neutral throttle button and advance the throttle handle. To return to normal operation, return the throttle to the NEUTRAL position.

IMPORTANT

The engine will only start in NEUTRAL. If engine does turn over and battery is charged, make sure the throttle handle is in NEUTRAL and try again.



CAUTION

DO NOT shift too quickly from FORWARD to REVERSE. Stay in NEUTRAL or idle position until the boat has lost most of its headway before completing the shift to REVERSE, or engine/transmission damage can occur.

Shifter/Throttle Control Handle

Shifts from NEUTRAL to FORWARD or REVERSE and controls throttle position.

Safety Lockout Ring (Shift Lockout)

Detent to prevent shifter from going into gear without driver action.

Neutral Throttle Button

Allows the throttle to be advance without being engaged in gear.

TAPS² Rocker Switch

This controls the TAPS² system. View the TAPS² gauge to monitor position.

Tigé SpeedSet Control Panel – Optional

This panel controls the Tigé SpeedSet cruise control system. Refer to **Tigé SpeedSet** for operation.

Steering Tilt Lever

The steering tilt lever allows you to adjust the angle of the steering wheel. DO NOT adjust when the boat is underway.

Stereo Remote – Optional

This remote control allows the stereo to be controlled at the cockpit. For details on operation, refer to the stereo owner's manual.

Heater (Heater Fan Control Switch for the Optional Cockpit Heater)

This switch operates the fan to deliver heat to the cockpit and windshield. The switch is a four-position switch: Off, Low, Medium and High. The vents have a diffuser which can be opened to allow more air flow toward the cockpit or closed to direct all the air to the windshield as a defogger. The diffuser also rotates to direct air to a desired direction.

PORTS

12-Volt Ports

These receptacles can be used to power or charge cellular phones, MP3 players, video cameras or other electronics which can be powered or charged from a 12 V DC system. These ports are powered through a 20-amp circuit breaker.

NOTICE

DO NOT connect an accessory to a single port drawing more than 20 amps, or if all the ports are used, the total amperage must not exceed 20 amps. A hazardous situation or damage to the electrical system can occur.

iPod™/MP3 Port – Optional

This port provides a convenient means to connect your iPod™ or MP3 player to your boat's stereo system.

GAUGES



RZ4, RZ2, 24Vé, 22Vé



Z1, 22i, 20V, 20i

FUEL GAUGE indicates the approximate amount of fuel in the tank. The ignition switch must be in the RUN position to activate the gauge.

SPEEDOMETER indicates forward speed of the boat in miles per hour (MPH).

SPEEDOMETER/MULTIFUNCTION LED DISPLAY indicates forward speed of the boat, in addition to oil pressure, voltage and engine hours. Refer to the Tigé multifunction gauge for the ranges.

SPEEDOMETER with SpeedSet Multifunction LED Display indicates forward speed of the boat, in addition to the SpeedSet set speed, actual speed and engine hours.

ENGINE HOUR METER keeps a running total of engine hours while operating. Depending on Tigé model, the hour meter readout may be a separate gauge or incorporated within the tachometer unit.

Make sure the key is in the OFF position when the engine is not running. Accessory equipment (stereos, showers, etc.) should not be installed to operate when the key is in the ON position.

IMPORTANT

The hour meter will log time whenever the engine is running.

TACHOMETER indicates engine speed in crankshaft revolutions per minute, or RPM.

TACHOMETER/DIGITAL DEPTH FINDER / AIR/WATER TEMPERATURE DISPLAY indicates engine speed in crankshaft revolutions per minute, or RPM. In addition to RPM, the tachometer also displays depth, air and lake (water) temperature.

Digital Depth Finder / Air/Lake (Lake Water) Temperature Display

1. Turn the ignition key to the ON position.
2. Make sure the cruise control switch is off.
3. Scroll through the dash screens using the ▲/FASTER and ▼/SLOWER arrows on the SpeedSet until you reach the “Setup” screen.
4. Hold down the ▲ and ▼ arrows simultaneously until the screen changes.
5. Scroll down to “units.” Hold both ▲ and ▼ arrows until the word ENG flashes.
6. Let go of buttons and press ▲ one time. This will change the text to MET (metric).
7. Press ▲ and ▼ buttons simultaneously until the flashing stops to lock this setting. The screens will return to the setup screen. Use the arrows to go back to the original menu.

TAPS² GAUGE indicates the position of the TAPS² plate; refer to **TAPS² Operation.**)

Tigé Multifunction Gauge

- **fuel (FUEL LEVEL)** indicates the approximate amount of fuel in the tank. These readings are only approximate and allow an adequate margin of comfort.
- **volt (Voltmeter)** indicates electrical system operating voltage DC. Normal operating voltage at 5000 RPM is 14.75 ± 0.25 volts.
- **temp (Engine Temperature)** indicates the internal engine coolant temperature in °F. Normal operating temperature is between 165-195°. **If gauge indicates temperature above 195°, shut engine off immediately!**
- **oil (Engine Oil Pressure)** indicates the pressure in PSI (lbs per square inch) of the lubricating oil inside the engine. Normal pressure is between 10-30 PSI at idle and 30-60 PSI at running speed.

CIRCUIT BREAKER PANEL

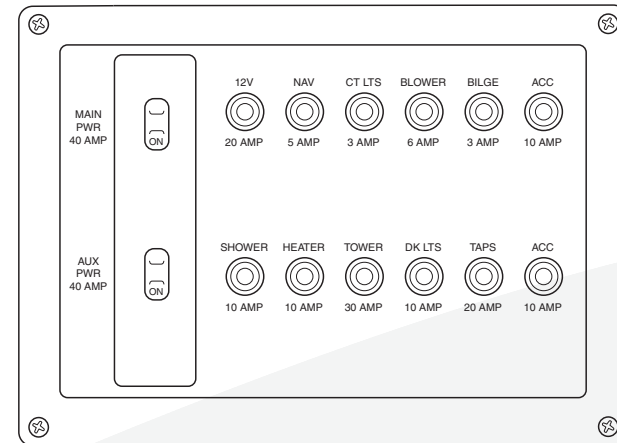

Standard and optional electrical equipment devices are protected by circuit breakers located under the dash. The pop breakers are labeled to identify the devices protected. The MAIN PWR and AUX PWR breakers provide power to their respective circuits. These PWR (power) breakers must be on to power the circuits.

The pop breakers will trip (pop out) if overloaded and cut power to the device. To reset, turn the device off (if applicable) and push the breaker in. If the pop breaker continues to pop out, see your Tigé Dealer. Your boat may not be equipped with all of the devices, features or options. Any accessory device added must not exceed the amperage of the breaker or total circuit capacity.

A quick way to check if a pop breaker is tripped is to run your fingers over breaker face to verify breaker is not “popped” out.

NOTICE

DO NOT connect an accessory or a device drawing more than the breaker's amperage capacity. A hazardous situation or damage to the electrical system can occur.



FUSES

Fuses protect the circuit by limiting the amount of current which can flow. Fuses are located under the dash and at the cranking battery. There are also mini-modular fuses in the fuse box, on the engine harness, on the top rear of the engine, near the ECM on the 5.7 L engine and on the back of the 6.0 L engine. Always carry spare fuses.

The following is a list of four fuses and their functions that are located on the engine, but not under the dash. These four fuses can prevent the engine from operating.

If a fuse should “blow,” it usually indicates a problem. See your Tigé Dealer. Use only an identical replacement when replacing the fuse.

- At the cranking battery, 10 Amp Modular Fuse (Ignition Circuit)
- 10 Amp Mini-modular Fuse (Injectors)
- 15 Amp Mini-modular Fuse (ECM)
- 20 Amp Mini-modular Fuse (Fuel Pump)

COCKPIT AND EXTERIOR

Battery Disconnect Switch

The battery disconnect switch allows you to isolate all power to the boat. This switch provides positive disconnection of the battery to protect against tampering, electrical fire hazards and battery rundown. Rotate the switch to the OFF position when the boat is not in use. This will not affect stereo memory or engine electronics functions.

Swim Platform

The swim platform is a convenient feature to enjoy water sports and provide a means of safety to boating. The swim platform is required for exiting and entering your boat and protects you from underwater components of your boat. The swim platform must be attached to the boat anytime it is used. There are very serious safety concerns regarding the use of the platform and safety labels are used to convey safety around the platform. For more information, refer to **Section 2, BOATING SAFETY**.

To remove the swim platform for storage or lifting V-drive models, remove the clips located in the mounting brackets, under the platform, tilt down and lift the platform. Reinstall the swim platform before you put your boat back into service. The swim platform must be attached to the boat anytime it is used.

Bow Features of Your Tigé

The open bow section of your boat has cushions which can be raised to access storage. The storage areas are for storage only and should not be occupied by passengers. These areas do not provide adequate ventilation and can accumulate CO.

The optional center bow cushion (RZ4, RZ2, Z1, 24Vé, 22Vé only) can be installed to create a bow sun deck. Store the cushion in the trunk or under the observer’s seat when it is not in use or before getting underway.

The Lexan® Walk-thru Windscreen (standard on RZ4 and RZ2 only) can be installed by sliding it into position and closing the windshield. Keep the windscreen in its protective boot and stow when it is not in use. The windscreen will not float.

Walk-Thru Windshield Opening/Latching

The two latches on the inside starboard side of the walk-thru windshield must be latched when the boat is underway or trailered. Rotate both of the window locks to secure or unlock the window.



DANGER

Exposure to carbon monoxide or a spinning propeller will cause death or serious injury. **DO NOT** use the swim/boarding platform for any other purpose than boarding the craft or preparation of entering the water, and **DO NOT** use the swim/boarding platform when the engine is running.



CAUTION

Glass door must be closed and secured with both locks when the boat is underway.

Cockpit Seating



WARNING

DROWNING OR LOSS OF CONTROL HAZARD

Ejection or sudden loss of control can cause death or serious injury from improper use of seating. **DO NOT** stand while driving above engine idle speeds and make sure cockpit seat is in the locked/secured position and all passengers are seated when the boat is underway.

The cockpit seat has a flip-up bolster for greater visibility and maneuverability while docking.

You can have the bolster raised and sit on the cushion or stand in front of it. Standing while driving should only be done while maneuvering at an idle speed by an experienced driver. To raise bolster, lift on the leading edge of the seat and raise into position.

The chair can be adjusted fore, aft or can rotate. You may have to move the seat fore or aft when rotating to avoid rubbing the chair on the side panel. Some dash and seating configurations may allow the seat to rotate completely.

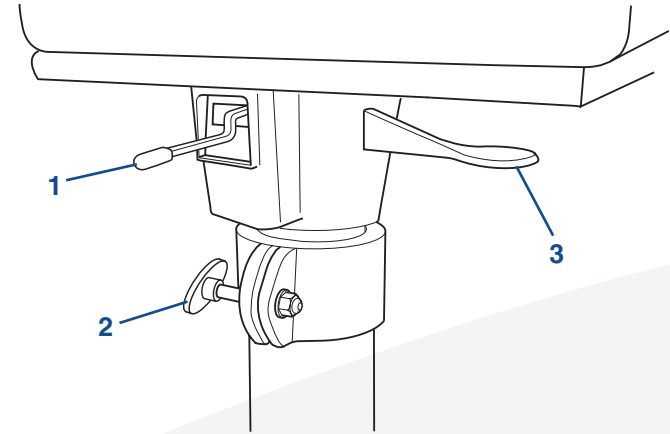

- Lift lever (1) to adjust fore and aft.
- To increase friction, rotate friction handle (2) clockwise, or counterclockwise to decrease friction. There should always be slight friction.
- To rotate, move chair slightly fore, then lift lever (3) to rotate. The lever will rest in a detent when locked into position.

The optional cockpit seat has the capability to adjust fore, aft, up and down, and rotate for greater visibility, maneuverability and comfort. You may have to move the seat fore or aft when rotating to avoid rubbing the chair on the side panel. Some dash and seating configurations may allow the seat to rotate completely.

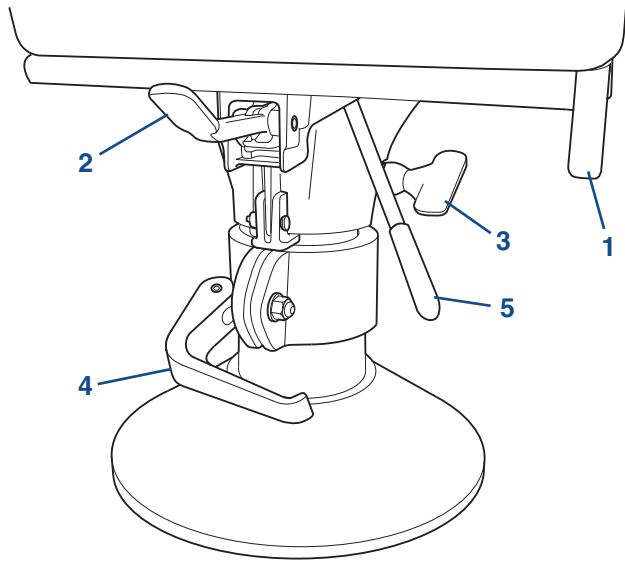

- ✦ Lift lever (1) to adjust fore and aft, release the lever to lock seat into the desired position.
- ✦ To rotate, move chair slightly forward, then lift lever (2). If you want to rotate the seat 360°, leave the lever up. If you want to lock the seat in a desired rotated position, push the lever down. The seat will lock into the rotation position within a few degrees.
- ✦ To increase friction, rotate friction handle (3) clockwise, or counterclockwise to decrease friction. There should always be slight friction.
- ✦ To raise or lower, loosen lever (4) lift lever (5) and the seat will rise automatically; release the lever at desired height. You may have to relieve down pressure on the seat for it to rise. To lower, lift lever when seated.

Cooler

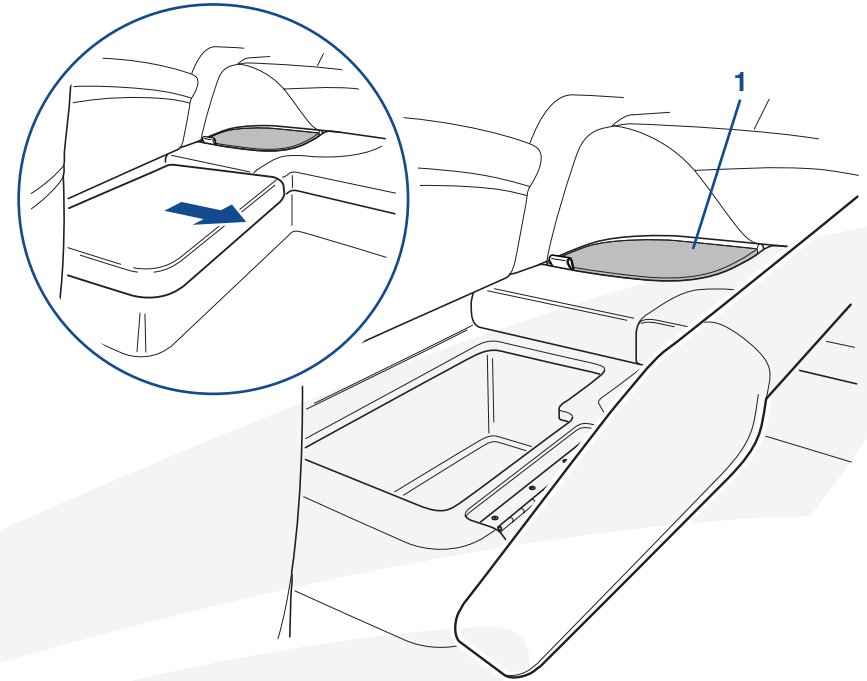

R22 Cooler shown

The cooler can be used to store miscellaneous items to keep food and drinks cool. The coolers are self-draining. DO NOT depend on the cooler to keep valuables or electronics dry. These types of items should be stored in a location which are not exposed to the elements or in a specialized dry bag. To clean the cooler, use a mild biodegradable soap only; DO NOT use abrasive cleaners.

The cockpit entrance tread (1) can be turned over to expose a carpeted tread for entering or exiting the cockpit. There is a cockpit entrance tread located on both sides of the cockpit.

Dash Storage

The dash storage/glove box is for dry storage only. It is equipped with a drain for water that enters the glove box. If your Tigé is equipped with a factory stereo, the glove box will house the stereo.

Cockpit Table – Optional, V-Drive only

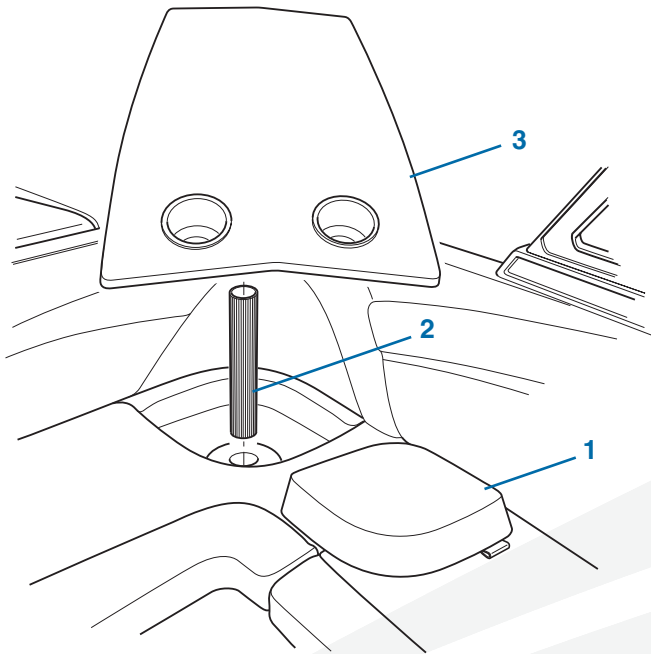

To install the table, remove the cockpit entrance tread (1) and stow. Insert the pedestal (2) into the mount and securely install the table (3). When using the dinette table, Do not sit or lean on the table top, or use it as a step. Do not exceed 50 lbs (22.7 kg). Protect the table top and pedestal when it is stowed and not in use.

EIDB Dual-Battery System – Optional

The EIDB dual-battery system protects your starting battery from discharging when high amperage accessories, like a high-output stereo system, are being used. The system allows the amperage to be drawn from the accessory battery only, without drawing from the starter battery. When the engine is restarted, both batteries will be charged, but will direct the charge to the weaker battery first.

Batteries

The standard battery is a heavy duty, marine grade 12 V battery. This battery primarily serves as the cranking battery and can operate standard equipment. A cranking battery is not designed to fully discharge like a deep cycle battery which can be fully discharged more often. It is not recommended to fully discharge the cranking battery.

The optional EIDB Dual-Battery System includes a cranking battery and a deep cycle battery. A Deep Cycle Battery is designed specifically for providing constant power to high-output stereo systems for extended periods of time.

Engine Compartment Cover

The engine compartment cover is a machinery guard and must be in place and closed whenever the engine is running. DO NOT operate your boat without the cover in place or closed unless you are performing a check or maintenance.



WARNING

MOVING PARTS HAZARD

Contact with moving parts can entangle, cut and cause death or serious injury. Never get close enough to make contact with any running machinery moving parts, i.e., engine or propeller. Contact can result in loss of body parts, strangulation, burns and/or severe loss of blood resulting in serious injury or death.



Direct Drive Models

The engine cover is a “wedge fit.” Make sure the cover is seated properly before getting underway.

V-Drive Models

To open the engine cover, lift the latch and turn counterclockwise. A gas shock will help raise the cover. To close and cover, pull down on and allow the cover to close firmly. Keep hands, fingers or any other obstructions clear of the cover when closing. To close the latch, turn latch clockwise and fold down.

Observer’s Seat

Lift up on the bottom of the observer’s seat to access storage under the glove box. Leave the seat up periodically to help keep the storage area dry.

Storage Hatch

To open the storage hatch, lift the latch and turn counterclockwise. A gas shock will help raise the hatch. To close and hatch, pull down on and allow the hatch to close firmly. Keep hands, fingers or any other obstructions clear of the hatch when closing. To close the latch, turn latch clockwise and fold down.

The storage hatch can be locked. The latch can be locked down to prevent the latch from being raised and rotated. Use the key to lock and unlock the latch. The key only requires about a 45° turn to lock and unlock.

Walk-Thru Windshield Opening/Latching

The two latches on the inside of the walk-thru windshield are to be closed when the boat is underway. Rotate both of the window latches to secure or unlock the window. Make sure both window locks are secure when your boat is underway. Always keep the window closed and secured when trailering your boat.

Water Sports Tow Pylon



WARNING

OVERLOAD HAZARD

Failure to inspect or properly install the tow pylon can cause the tow pylon to fail, resulting in death or serious injury. Inspect and make sure the tow pylon is installed correctly.

Improper use of the tow pylon can overstress the pylon, imbalance the boat or allow the tow rope to come into contact with passengers.

- DO NOT use the two pylon for towing parasails, kites or other watercraft.
- DO NOT tow more than one person at a time or exceed a load of 300 lbs (136 kg).
- DO NOT allow passengers to sit behind the tow pylon when it is in use.
- Check that the tow pylon is secure before every use.

The tow pylon is designed for towing a wakeboard or a ski device only.

Misuse of the tow-point can cause death or serious injury. The pylon was designed for water sports only. DO NOT use the parasailing, kite flying, towing other watercraft and/or using pylon extensions. DO NOT sit behind (aft) the pylon when tow pylon is in use.



The water sports tow pylon is manufactured from high-strength aluminum alloy, engineered for durability. The tow pylon is rated to tow one person and not to exceed the weight of 300 lbs (136 kg). If the load limit is exceeded or becomes loose when towing, the tow pylon could separate from the boat. If the pylon separates from the boat and because of its mass, it could become a missile hazard and strike someone, causing death or serious injury.

Make sure the tow pylon is secured to the boat before each use. Tow pylons can loosen over time, and must be inspected and tightened before every use. If the tow pylon is loose when towing, it could separate from the boat.

Although pylon extensions and barefoot booms have become popular additions to many tournament inboards, most boat manufacturers object and oppose the use of any pylon extension, whether up or to the side of any of their products. The use of pylon extensions can alter the handling characteristics of the boat, possibly resulting in dangerous instability, which can lead to loss of control or a situation which can cause death or serious injury to the boat driver, passengers, skiers and anyone else who might be in the vicinity.

Pull-out Cleats

The pull-out cleats allow the cleats to be stowed into the boat's exterior when they are not in use. Pull the cleats out when they are to be used and return them when they are not in use. **DO NOT** use the cleats for towing or tying as an anchoring point.

Lockdown Boat Cover – Optional

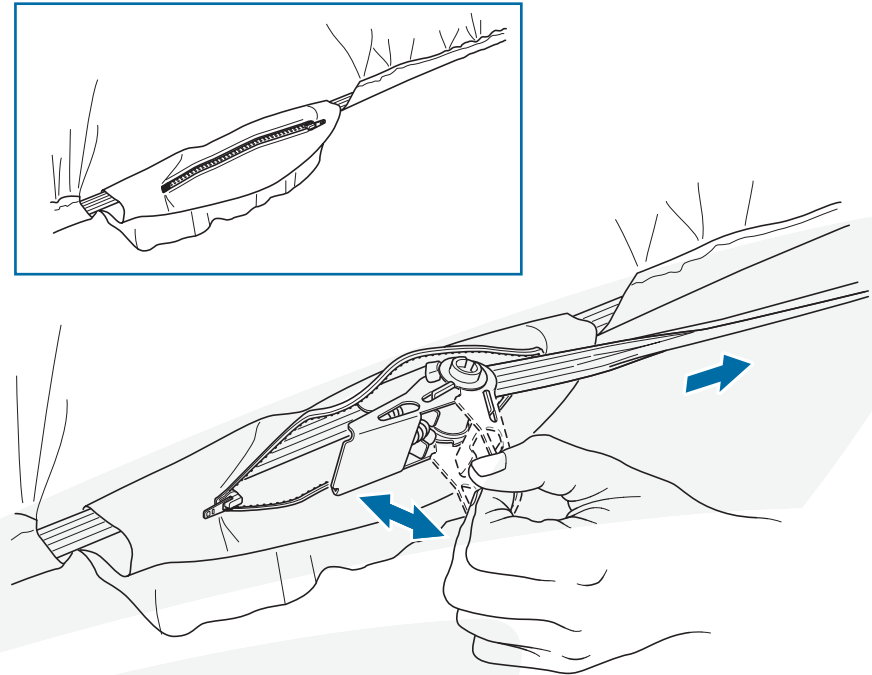

The lockdown boat cover is designed to protect your boat during trailering and short-term storage.

Start by installing the cover from the stern of the boat and unfold the cover as you move it fore. The cover has a label “REAR” to identify the stern end of the cover. Insert the pole support to help with rain run-off.

After the cover is installed, use the clamp strap to draw the cover snug around the boat, below the rub rail. Pull the excess strap aft, and winch the clamp to draw the cover. Lock the clamp. Position any excess strap into the protective boot and zip closed to protect the clamp from possibly making contact with your boat.

Section 5

OPERATION

There are many things to consider when planning a safe and enjoyable boating trip. This section describes the basics on fueling, starting, shifting/running, steering, docking and stopping your boat. This section also includes a safety preflight checklist, boarding guidelines, boat loading information and other important topics on handling your boat. Knowing and understanding all of these fundamentals will give you confidence in using your boat.

GETTING UNDERWAY

Read and understand the contents of this section before casting off. Remember, if you have a problem during your outing, you cannot get out and fix it, or walk to safety or for help. You are responsible for the safety of all passengers, the boat and any damage your boat or its wake may cause. Always keep passengers from blocking your view so that you do not run into other boats, swimmers, water skiers, personal water vehicles or aids to navigation.



PREFLIGHT CHECKLIST

The following checks are essential to safe boating and must be performed before starting the engine. Get in the habit of performing these checks in the same order each time so that it becomes routine.

DO NOT launch the boat if any problem is found during the safety check. A problem could lead to an accident during the outing causing severe injury or death. Have any problem attended to immediately; see your dealer.

Before launch:

- ✦ Check and tighten all hardware including pylons, towers, speakers and other accessories.
- ✦ Energize Electrical System. Energize system by:
 - Turning on the Battery Disconnect Switch located near the battery (see page 6-10 or 6-12 for location).
 - Switch MAIN PWR and AUX PWR to “ON” on the Circuit Breaker Panel (page 4-23) located under the dash (see page 4-6 or 4-8 for location).
- ✦ Check fuel level. If possible, fill tank at a land-based fueling station. Marina gas sometimes contains water and is usually more expensive.
- ✦ Make sure the Saltwater Flush Kit shut-off valve (if equipped), and/or seacock on water pickup (seacock applies to all models sold in Canada), is open (handle in-line [OPEN] with hose, not perpendicular [CLOSED]).
- ✦ Check engine oil level.
- ✦ Check transmission fluid level.
- ✦ Check battery charge.
- ✦ Check and operate the blower.
- ✦ Check that bilge drain plug is installed properly.
- ✦ Check the propeller, strut and rudder for damage.
- ✦ Check the weather report, wind and water conditions.
- ✦ Lift engine compartment cover for to check for evidence of gasoline fumes.
- ✦ Check that the required safety equipment is on board.
- ✦ Check that the fire extinguisher is fully charged.

- ✦ Check that all required maintenance has been performed.
- ✦ Check bilge pump operation and make sure bilge is free of debris.
- ✦ Check steering and rudder movement.

Make sure adequate number of PFDs and all other Coast Guard-required items are onboard and accessible.

Launch:

- ✦ Operate the blower for at least four minutes before starting engine.
- ✦ Check bilge for leaks.
- ✦ Stow gear and clothing.

Pre-Operation:

- ✦ Check that no fuel, oil or water is leaking or has leaked into the bilge compartment.
- ✦ Check all hoses and connections for leakage and damage.
- ✦ Check the engine cooling water intake pick-up for blockage.
- ✦ Check that battery terminals are clean and tight.
- ✦ Check electrical circuits (lights, pumps, horn, etc.) for proper operation.
- ✦ Check that shifter/throttle control handle is in NEUTRAL.
- ✦ Check that the steering system operates properly.

During Operation:

- ✦ Monitor gauges frequently for signs of abnormal behavior.
- ✦ Check that controls operate smoothly.
- ✦ Check for excessive vibration.

After Operation:

- ✦ Fill fuel tank to prevent moisture from condensation.
- ✦ Check for fuel, oil and water leakage.
- ✦ Check the propeller for damage.

FUELING

**WARNING****FIRE/EXPLOSION HAZARD!**

Gasoline vapors are highly explosive when exposed to open flame or spark resulting in death or serious injury. Run blower for at least four minutes before turning on any electrical devices or starting the engine.

- Stop all engines, motors and fans before refueling.
- Do not smoke or allow open flames or sparks nearby, within 50 ft (15 m) of the fueling area.
- Maintain contact between the fuel nozzle and the fuel tank to prevent electrostatic spark. **DO NOT** use a plastic funnel.

Try not to spill gasoline. If gasoline is spilled, wipe up all traces of it with dry rags and immediately dispose of the rags properly onshore.

When fueling:

1. Close all doors, hatches, windows and other compartments.
2. Extinguish cigarettes, pipes and all other flame-producing items.
3. Make sure all power is off, and **DO NOT** operate any electrical switches.
4. Remove fuel fill cap. Insert hose nozzle and make sure nozzle is in contact with or grounded against fill opening. This will reduce the risk of a static spark.
5. Add fuel in accordance with the engine owner's manual. **DO NOT** fill to capacity to allow for fuel expansion.
6. Tighten the fuel filler cap completely after refueling.
7. Check oil level.

NOTICE

Each time you fill up, inspect fuel lines for leaks and hose deterioration.

After fueling, make sure fuel and oil fill caps are tightened securely and wipe up any spillage.

**CAUTION**

To prevent engine damage, refer to the engine owner's manual for manufacturer's recommended fuel.

SHIFTING/RUNNING

When shifting your boat, follow these guidelines:

Pause in neutral before shifting from FORWARD to REVERSE, or REVERSE to NEUTRAL.

- Avoid shifting into reverse while the boat is traveling forward at speed.
- Keep the shifter control clean and clear of obstructions.

To shift into forward:

Push shifter/throttle control handle forward to go forward.

To shift into reverse:

Push shifter/throttle control handle back for reverse.

STEERING

Practice steering your boat. Make sure the steering system is working correctly and is properly maintained. Have the steering system checked regularly.



WARNING

LOSS OF CONTROL AND UNSAFE BOAT HAZARD

Hazard from improper maintenance of steering system is hazardous and can cause death or serious injury from sudden loss of control. Make sure all steering hardware, cables and fluid levels are regularly inspected and maintained.

Boats have a tendency to wander at slow speeds and steering the boat back and forth will result in over-steer. Keep the steering wheel in the center position and make slight adjustments.

STOPPING

1. Slowly bring the shifter/throttle control handle to the idle position. If the boat has been driven for a long period of time at high speed, allow the engine a two- to three-minute cooldown period at idle.
2. Turn the ignition key to the OFF position.
3. If any problems were encountered during the outing, have the boat inspected by your dealer and request any necessary repairs before the next outing.

DO NOT use the emergency stop switch to shut off the engine.

DOCKING

Practice docking before attempting it for the first time. Use a float, like a plastic milk jug with a line and small weight, as your docking target. Remember, your boat is steered with a rudder and maneuvering at slower speeds takes practice.



WARNING

CRUSH HAZARD

Using your hand, arm or other part of your body to attempt to keep the boat from hitting the dock can result in serious injury. DO NOT use any body part to keep the boat from hitting the dock.

Dock and Mooring Lines

Use enough fenders to protect the craft from damage and good quality double-braided nylon line. Only use the cleats, bow eye and stern eyes to secure the craft. DO NOT use the handrails or windshield. The foredeck handrails should only be used for tying a “jackline” in an emergency situation.



Follow these guidelines when docking:

- Approach docks slowly with the port side of the boat if possible.
- Come to a stop a short distance from the dock, then proceed slowly.
- Have fenders, mooring lines and crew ready.
- Observe how the wind and current are moving your boat. Approach the dock with the boat pointed into the wind, if possible. If the wind or current is pushing you away from the dock, use a sharper angle of approach. If you must approach the dock downwind or down current, use a slow speed and shallow angle. Be ready to reverse to stop and maintain position.
- If there is no wind or current, approach the dock at a 10- to 20-degree angle.
- If possible, throw a line to a person on the dock and have that person secure a bow line.
- With the bow secure, swing the stern in with the engine, or pull it in with a boat hook.

If the boat is to be moored for a long period of time, use chafing protectors on lines to protect the gelcoat finish. Leave slack in the lines to allow for some wave movement or tidal action if applicable.

Follow these guidelines when departing:

- Very slowly shift into forward at idle speed.
- When the stern moves away from the dock, turn the engine away from the dock.
- Cast off bow line and back away.

If the wind or current is pushing away from the dock, cast off all lines and allow to drift until you are clear.

STARTING

1. Run the blower for at least four minutes before starting the engine. If you smell gasoline fumes, do not start the engine. Continue to run the blower until fumes have dissipated.



WARNING

FIRE OR EXPLOSION HAZARD

Gasoline vapors are highly explosive when exposed to open flame or spark resulting in death or serious injury. Run blower for at least four minutes before turning on any electrical devices or starting the engine.

2. Make sure the Saltwater Flush Kit shut-off valve (if equipped), and/or seacock on water pickup (seacock applies to all models sold in Canada), is open (handle in-line [OPEN] with hose, not perpendicular [CLOSED]).
3. Make sure the emergency stop switch is attached to the switch and the lanyard is attached to the operator.
4. Make sure the shifter/throttle control handle is in NEUTRAL.
5. Turn the key clockwise to the START position. After the motor starts, release the key.
6. Push shifter/throttle control handle forward to go forward, pull back for reverse.

Always pause in NEUTRAL before going into REVERSE to avoid taking water in over the transom.

TAPS² OPERATION



Working in conjunction with the patented Tigé ConvexV hull, TAPS² allows variable-hull trim capability that dramatically enhances wake characteristics, ride and overall boat performance. With the push of a button, TAPS² instantly modifies the hull's running angle for optimum watersport wake enhancement, a smoother ride in rough water, better fuel economy and increased safety and comfort.

TAPS² adjustments are made using the rocker switch located on the throttle handle. Always keep your left hand on the steering wheel and your right hand on the throttle.

The location of the TAPS² switch allows operation with the right thumb, maintaining safe, hands-on control of the throttle.

TAPS² switch adjustments can be made while stopped or while underway at any speed. The position of TAPS² plate is indicated on the TAPS² gauge located on the dash.

Settings range from 1, a flat, bow-low running angle to 8, a bow-high running angle. To move the bow to a higher running attitude, push the top of the TAPS² rocker switch (the TAPS² will raise). The TAPS² gauge will begin moving toward a higher number. To lower the bow, push the bottom of the TAPS² rocker switch. The bow angle will lower and the TAPS² gauge will move to a lower number.

Although the effects of the various TAPS² settings depend on Tigé model, passenger load, water conditions, speed and other factors, the following guidelines are provided as a starting point as you learn to use TAPS² to optimize your performance needs. Practice and experience using TAPS² can also optimize your performance needs.

WATER SPORTS SETTINGS

TAPS² has been designed for “shift-on-the-fly” adjustment of wake size and shape. Generally, the larger the wake desired, the higher the TAPS² setting.

Slalom

Because the best TAPS² setting for slalom is the one which best suits the skier, experiment with the TAPS² settings and take full advantage of the system's full variability.

For kids skiing below 15 MPH, try a setting between 0 and 2. Skiers in the 15-32 MPH range usually require a setting between 1 and 3. At or above 32 MPH, skiers will prefer a setting from 1 to 4.

Remember, the optimum TAPS² setting will vary depending on passenger load, line length, water conditions, etc. A slight TAPS² adjustment can make a big difference in wake size and shape, so do not hesitate to use the switch.

Wakeboarding

Experienced riders will find that the largest, pro-size wakes will be achieved with a TAPS² setting at 8+. If you have a full passenger load or skybox seating, use TAPS² at a lower setting to dial in the optimum wake shape. For recreational or intermediate riders, we recommend a maximum TAPS² setting of 4.

Other Water Sports

TAPS² also dramatically enhances wake characteristics for air chairs, barefooting, kneeboarding and towables. Experiment with different settings, have a great time, but be safe!

Helpful Hint

For best ride and performance, use the extreme slalom setting (1) only when pulling up a skier or boarder or at towing speeds under 24 MPH. At speeds greater than 24 MPH, adjust TAPS² to a setting more conducive to the water conditions.

Ride, Safety and Boat Performance

The variable-hull TAPS² system also dramatically enhances boat performance, comfort and safety. To eliminate bow rise on take-off, set TAPS² at 1. As soon as the boat reaches planing speed, adjust TAPS² to 3 or higher, depending on water conditions. If the water is choppy, less than 6 in. (152.4 mm) waves, the optimum ride setting will be from 2 to 5, depending on Tigé model and passenger load. If the water is rougher, 6 to 12 in. (152.4 to 304.8 mm) waves, the optimum ride setting will be from 5 to 8, depending on Tigé model and passenger load.

Raising the bow in rougher water will provide a safer, drier ride while maximizing the hull's "entry vee" to reduce the effects of the chop. This higher running attitude will also provide bow passengers with a smoother, drier ride.

To maximize top speed in your Tigé, set TAPS² between 5 and 8. When the boat reaches top speed, bring the TAPS² setting down slightly to achieve the optimum running attitude. Top speed should be achieved at a TAPS² setting of 5 to 6.

TIGÉ SPEEDSET CRUISE CONTROL OPERATIONS

Available as an option on all Tigé models, Tigé SpeedSet allows precise, easy-to-use digital speed control that is useful in towing wakeboarders and skiers or maintaining a constant cruising speed. The SpeedSet control panel incorporates Touchpad Recognition for easy fingertip use without taking your eyes off the waterway. Raised, domed buttons are scaled to the human hand and positioned to allow for two-finger touch operation while you safely pay attention to your rider or skier and other boat traffic.

Before using Tigé SpeedSet take time to familiarize yourself with the system and its operations.

The system will only operate when the dash CRUISE CONTROL switch is toggled ON. If this switch is toggled OFF during SpeedSet operation, the system will disengage as soon as the throttle is brought back below the set point.

Tigé SpeedSet resets each time the CRUISE CONTROL switch is manually toggled off and the throttle arm is brought below the set position.

Tigé SpeedSet is solely governed by the throttle. If you desire to stop your boat at any time, pull back on the throttle arm.

To Set Tigé Speedset

Toggle dash CRUISE CONTROL switch to ON position.

There are two ways to set Tigé SpeedSet:

- At idle, preset the desired speed using the UP/DOWN buttons on the SpeedSet control panel. The preset speed appears in the center dash digital readout. Push the throttle handle fully open to give Tigé SpeedSet full throttle authority. The boat will accelerate to the preset speed.
- While underway, accelerate to the desired speed and press the SPEEDSET button on the center of the SpeedSet control panel, then push the throttle handle fully open to give Tigé SpeedSet full throttle authority. The boat will maintain the set speed.



Pulling the throttle arm back will instantly disengage SpeedSet, allowing the boat to slow or come to a stop. Tigé SpeedSet will allow slowing and stopping, it will not allow the boat to go over the set speed.

For example, if you are towing a skier at a set speed and the skier falls, simply pull back on the throttle arm. The boat will slow and you can resume normal throttle operation to turn around to pick up the skier. As long as the CRUISE CONTROL switch remains ON, Tigé SpeedSet will remember the set speed. To begin towing the skier again, push the throttle arm completely open and Tigé SpeedSet will accelerate the boat to the previously set speed.

To Increase Speed While Using Tigé SpeedSet

There are two ways to go to a higher speed:

✦ Hold down the FASTER button and release it when you reach desired speed.

OR

✦ Press the FASTER button in increments (about a half a second each time).

Each time the FASTER button is pressed, your speed increases by about a 0.2 MPH. This is useful for small speed changes desired by the person being towed.

For example, if you desire to go 1 MPH faster, press the FASTER button five times (about a half second each time) and Tigé SpeedSet will take you to your desired speed.

To Reduce Speed While Using Tigé SpeedSet

There are three ways to reduce your speed:

✦ Hold down the slower button and release it when you reach the slower speed.

OR

✦ Press the SLOWER button in increments. Each time the SLOWER button is pressed, your speed decreases by about 0.2 MPH, the same increment as the FASTER button.

OR

✦ Pull the throttle arm back to your desired speed.

To erase the Tigé SpeedSet memory and regain throttle authority, turn OFF the CRUISE CONTROL switch on the dash.

For example, if you are cruising using Tigé SpeedSet and want to regain throttle authority for quick acceleration, simply toggle the Cruise Control switch OFF (this resets the memory), back off the throttle and then move it forward to achieve your desired speed. This can be done quickly or slowly.

Troubleshooting

No throttle power when you start your boat engine:

Move throttle to neutral and verify that the dash Cruise Control switch is toggled OFF.

Boat does not seem to maintain speed on turns or in rough waters:

Verify that you have given your boat plenty of throttle authority (move the throttle forward).

Engine power cuts out and then in:

This usually occurs when the throttle is positioned at, or near, the set speed. Move the throttle to the full forward position after the speed is set, giving Tigé SpeedSet adequate throttle authority.

SAFETY EQUIPMENT

Federal and local laws require certain safety equipment to be onboard at all times. In addition, responsible boaters carry other equipment in case of emergency. Check with local boating authorities for any additional requirements over and above federal requirements.

Refer to **Section 2, SAFETY, Required Safety Equipment**.

BOARDING

When boarding the boat, always step in. Do not jump. Avoid stepping on fiberglass or other potentially slippery surfaces. Board one person at a time.

DO NOT board the boat while carrying gear. Set gear on the dock, board the boat and then pick up the gear.

BOAT LOADING

The performance of your boat is dependent on load weight and distribution.

Passengers should board one at a time and should distribute themselves to maintain trim. Remember to distribute weight from right to left, and also from front to back.

All passengers should be carefully seated and not be riding on the deck, gunwale or rear sun deck while underway. Passengers riding in the bow should exercise extreme caution. Do not overload the open bow area. Never seat more than three people in the open bow area. Maximum weight capacity for the open bow area is 250 lbs (combined weight of persons and gear). Children under 11 years of age should not use the open bow area unless accompanied by an adult. During rough water operation, passengers in the bow should move to the aft passenger seats.

- DO NOT allow your passengers to ride with their feet dangling over the side; floating debris can cause serious injury.

- Avoid excess weight in the bow or stern.
- Securely stow all extra gear in stowage areas to prevent load shifting.

Do not stow gear on top of safety equipment; safety equipment must be quickly accessible.

In adverse weather, reduce the load in the boat. People/load capacity ratings are based upon normal boating conditions.

RUNNING

We urge you and all others operating the boat to seek certified instruction from local boating authorities.

This section is designed to present the most basic operational principles. It is not intended to cover all conditions encountered during operation.

The principles presented in this manual are limited to the facts related directly to the operation of the boat, while the responsibility for the proper application of these principles belongs to you.



MANEUVERING TECHNIQUES

Steering response depends on three factors: engine position, motion and throttle.

High-speed maneuvering is relatively easy and takes little practice to learn.

Slow-speed maneuvering is more difficult and requires time and practice to master.

When making tight maneuvers, it is important to understand the effects of turning. Since both thrust and steering are at the stern of the boat, the stern will push away from the direction of the turn. The bow follows a smaller turning circle than the stern.

The effects of unequal propeller thrust, wind and current must also be kept in mind. While wind and current may not always be present, an experienced boater will use them to their advantage. A counterclockwise rotation propeller tends to cause the boat, steering in the straight ahead position, to drift to port slightly when going forward, and to starboard when going backward. At high speed, this effect is usually unnoticed, but at slow speed, especially during backing, it can be powerful. More experienced boaters approach the dock with the starboard side of the boat toward the dock, if possible.

Stopping (checking headway) is a technique that must be developed. Since a boat has no brakes, reverse thrust is used to slow and stop the boat. The momentum of the boat will vary according to the load as well as the speed.

Make it a practice to slow to idle (no-wake) speed before shifting into reverse.

It is best to learn maneuvering skills in open water away from traffic. Practice is the only way to develop your boating skills.

SALT WATER

If boat is moored in salt water for long periods, allow the cooling system to drain thoroughly after removing the boat from the water. Hose down the entire hull with fresh water and wipe dry.

Today's engines are built for operation in either fresh or salt water. Fresh water internal flushing is not normally required; however, it may be desirable after use in salt, polluted, or brackish water. Your Tigé Dealer will assist you in securing the appropriate engine flushing device.

FREEZING TEMPERATURES

When the boat will be operated and left in the water and temperatures drop below freezing, drain the engine completely when the boat is removed from the water.



TOWING PROCEDURE

If water is rough, it may not be easy to extend the tow line from one boat to another. In these cases, use a light throwing line with a weight on one end and with the heavier towing line secured to it.

Never attempt to tow a much larger or grounded vessel. Because of the tremendous stress caused by towing, use a tow line that is rated at least four times the gross weight of the boat being towed. Tow ropes must always be in good condition, free of any cuts or abrasions.

Attach tow line to the bow lifting eye on the disabled boat. Attach the opposite end of the bridle only to the stern lifting eyes of the tow boat. Wrap the bridle with chafing gear where it rubs against the boat or any corners. Leave at least two boat lengths between the boats for adequate movement.

When towing, use only the bow and stern eyes; never use cleats, handrails, etc. Do not allow anyone to be in line with the tow rope. If the rope should break or pull free, a dangerous recoil could occur.

Adjust the tow line to match wave action. Keep the boats on the crest or in the trough of the waves at the same time. In protected, calm waters, shorten the line for better handling. Always tow at moderate speed, allowing for adverse wind and wave conditions. Have the operator of the towed boat steer with you if possible.

If you need a tow, or wish to tow another boat, use great care. The boat structure can be damaged by excessive pulling strain. You should always offer help to a boat in trouble; however, towing a capsized, grounded, or hull-damaged boat is dangerous. Give assistance to the occupants, and then call the proper authorities.

ANCHORING

Dropping Anchor

There are many types of anchors available on the market. The choice of one anchor over another depends on many factors. An anchor will usually hold best in a mixture of mud and clay or in hard sand. A lightweight Danforth anchor is recommended for general boating. For more information on anchors, see your dealer.



WARNING

SINKING OR DROWNING HAZARD

Anchoring at the stern can pull a boat under water and keep it there. DO NOT anchor at the stern.

- Make sure the line is tied to the anchor and tie the other end of the line to the bow lifting eye.
- Head the boat into the wind or current over the spot where you want to lower the anchor.
- Stop the boat before lowering the anchor.
- When the anchor hits bottom, slowly back up the boat, keeping tension on the line. Let out an anchor line that is four to six times the depth of the water. For example, if you are in 10 ft (3 m) of water, let out 40 to 60 ft (12 to 18 m) of line.
- Secure anchor line to the bow lifting eye. Pull on line to make sure anchor is holding.
- Occasionally check your position against the shoreline. If the anchor is dragging and you are drifting, reset the anchor.

Weighing (Pulling In) Anchor

Start engine and move forward until anchor line is straight up and down.

Pull hard to lift anchor from the bottom material.

If the anchor is stuck, allow the up and down motion of the bow from wave action to loosen the anchor from the bottom. If the anchor remains stuck, slowly maneuver the boat around the anchor until the anchor pulls loose. Be sure to keep the line tight during this procedure.

PERFORMANCE BOATING

Some boat models, especially those with high horsepower engines, are capable of truly exhilarating performance. Do not be tempted to push your boat to its limits until you are completely familiar with the boat's operating characteristics. The operator should have at least 10 hours of experience with the boat before any extended full throttle operation.

Here are some guidelines for performance operation. Read and practice them, and soon you will be operating your boat to its full capability.

Before Running

- Keep the bottom clean and free of scum, barnacles and other growth. Growth on the hull can slow the boat down considerably.
- Prepare the boat. Be sure all gear is properly stowed and compartments are latched.
- Keep weight in the boat low and evenly distributed. Remove unnecessary weight and keep it onshore. Weight distribution affects performance.
- The propeller should be of the proper pitch to turn the recommended RPM rating for the engine and of the proper type for your average load and individual requirements. Your Tigé boat is already equipped with the proper propeller to achieve maximum performance with an average load for your boat. If you have questions, see your Tigé Dealer.



When Underway

If the boat begins to operate in an unsafe way, pull back on the throttle. Monitor the gauges when operating at full throttle.

As the boat begins to get on plane, acceleration will increase since less boat will be in the water.



WARNING

LOSS OF CONTROL AND UNSAFE BOAT HAZARD

Failure to maintain control can cause death or serious injury. Keep one hand on the wheel and the other on the shifter/throttle control handle.

High-speed operation on smooth water is very stable, but quick reactions and adjustments are needed to maintain control. Know your limits and stay within them. Always keep one hand on the steering wheel and the other on the throttle; constant adjustments are necessary for rapidly changing conditions. Small inputs of throttle and steering are exaggerated at high speeds. Depending on the speed, keep watch well ahead so that you may have enough time to react.

PROPELLERS

The propeller converts the engine's power into the thrust needed to propel the boat. Care and selection of your propeller is very important to proper boat operation. Propellers are identified by two numbers, such as 13 x 19. In the number sequence, the first number is the diameter of the propeller and the second is the pitch.

Pitch is the angle of the blades expressed in the theoretical distance a propeller travels in each revolution. In the above example, the pitch is 19, or each revolution of the propeller pushes the boat 19 in. (483 mm) through the water. A 19 pitch is considered "higher" pitched and a 15 pitch propeller is considered "lower" pitched.

Your Tigé boat is already equipped with the proper propeller to achieve maximum performance with an average load, for your boat. If you have questions, see your Tigé Dealer.

Keep these guidelines in mind when selecting a propeller:

- Engine RPM must be within the recommended operating range. Refer to the engine owner's manual.
- Higher propeller pitch reduces: RPM, acceleration and engine noise, and usually improves fuel economy and top speed.
- Lower propeller pitch increases: RPM, acceleration and engine noise, and reduces fuel economy and top speed.

Refer to **Section 7, CARE AND MAINTENANCE, Propeller**, for information on removal and installation.



Section 6

BOAT SYSTEMS

Knowing the systems on your Tigé boat is as important as knowing the switches, controls and indicators on your boat. System knowledge is essential for safe and proper operation and integrity.

When replacement parts are required, DO NOT substitute marine-grade parts with anything other than parts with equivalent characteristics, including type, strength and material.

Marine-grade parts are specifically designed for the conditions and environment which marine products are exposed to. Using substandard parts could result in injury and product failure.



WARNING

FIRE OR EXPLOSION HAZARD

Gasoline and other fuels are extremely flammable and highly explosive under certain conditions.

- DO NOT smoke or allow open flame or sparks nearby when refueling.
- DO NOT block fuel vents.
- DO NOT store fuel in any containers or compartments which are not designated for fuel storage and DO NOT use these storage areas for any other purpose.





WARNING

LOSS OF CONTROL AND UNSAFE BOAT HAZARD

Improper maintenance of boat systems is hazardous and can cause death or serious injury from sudden loss of control. Make sure all systems are regularly inspected and maintained.



WARNING

FLOODING OR DROWNING HAZARD

A water system component failure is a flooding or drowning hazard which can cause death or serious injury. Maintain all water system components and keep seacocks closed during periods of inactivity.

STEERING

Your Tigé boat has a mechanical steering system. When the steering wheel is turned, the dash unit transfers rotary motion of the wheel to linear motion in the cable which pushes or pulls the rudder arm.

Boat steering is not self-centering. Always keep a secure grip on the steering wheel to maintain control. Improperly maintained controls are dangerous.

Check steering operation and visually inspect for loose or missing hardware before operating the craft. If you suspect the steering system is damaged, see your dealer. DO NOT operate the craft if you suspect the steering system is malfunctioning.

ENGINES

Your Tigé boat is powered by a single MarinePower® inboard engine. The specific operation, specifications, maintenance and troubleshooting information is contained in the engine owner's manual included in your Owner's Kit. Familiarize yourself with the information contained in the engine owner's manual. Following the manufacturer's recommendations and guidelines will provide you with continued boating pleasure and engine integrity.

TRANSMISSIONS

The transmission has one forward and one reverse speed, and is shifted by the shifter/throttle control handle.

V-Drives

The power generated by the engine is transmitted as a combination of the straight inboard and the V-drive transmission (a series of gears), which drives the shaft coupling and the propeller shaft assembly. The propeller shaft is supported and aligned with the engine by a thru-hull shaft log and an outside strut.

Direct Drives

The power generated by the engine is transmitted to the propeller via the direct drive transmission, a shaft coupling and the propeller shaft assembly. The propeller shaft is supported and aligned with the engine by a thru-hull shaft log and an outside strut.



Propellers

The propeller installed on your Tigé boat was selected because of its diameter and pitch to provide the optimum speed and performance under average conditions of load. The propeller selection must be based on the ability of the engine to turn the propeller and achieve the manufacturer's recommended RPM at full throttle.

STRUT AND BEARING

The propeller shaft is supported on the outside of the hull by a strut. The strut is equipped with a water-lubricated plastic bearing to allow the propeller shaft to rotate in the strut.

NOTICE

The strut bearing is lubricated by water. DO NOT shift the transmission and run the propeller out of the water even if the water is supplied to the engine's cooling system. Damage to the shaft and bearing can occur.

ELECTRICAL SYSTEM

Your Tigé boat is equipped with a direct current (DC) system which is battery-powered and supplies electricity to lights, pumps, blowers, engine ignition and accessories. The alternator from the engine produces alternating current (AC) and converts it to DC, which provides power while the engine is running and also charges the battery or batteries, if your boat is equipped with more than one battery.

The electrical system is controlled by the battery disconnect switch, located in engine compartment and MAIN switch on breaker box. The electrical system is protected by circuit breakers on the breaker box. The breaker box is located under the dash. Make sure the battery disconnect switch and the MAIN switch on breaker box are both ON and make sure no breakers are tripped. Run fingers over breaker face and reset any tripped circuit breakers.



WARNING

FIRE OR EXPLOSION HAZARD

An AC/DC can create sparks. In the presence of explosive gases, fire or explosion can occur. Check for explosive gases or run the blower.

DO NOT work on an energized system. Disconnect the negative cable from the battery before performing any service.

FUEL SYSTEM

The fuel system consists of a built-in fuel tank, a fuel tank vent, a port fuel fill on direct drive models, a port and starboard fuel fill on V-drive models.

The fuel tank is located mid-ship, fore of the engine. To inspect the hose connections, raise the floor panels. Your Tigé Dealer or a qualified service technician should perform all fuel system service.



BALLAST TANK SYSTEM (optional)

The patented Tigé ConvexV hull and TAPS² technology is designed to deliver phenomenal wakeboarding wakes without ballast or drag hardware. However, Tigé does offer an optional ballast system for expert riders performing extreme-level tricks. The system consists of tanks, pumps and valves (or seacocks). The pumps fill and drain the tanks and the valves allow the system to be opened or closed.

When ballast is used, the available load weight in the boat must be reduced. This means fewer passengers and/or less gear are allowed to keep the boat within legal and safe weight limits. An average boat passenger is defined as 141 lbs (64 kg) per person. Water weighs approximately 8.4 lbs per gallon (1 kg per liter).

BILGE SYSTEMS

NOTICE

The Federal Water Pollution Control Act prohibits the discharge of oil or oily waste into the water. Violators can be fined \$5,000.

IMPORTANT

Bilge pumps and bilge pumping systems are not designed for damage control. Check the function of all bilge pumps at regular intervals. Debris can also prevent pumps from functioning or also make it operate continuously. Make sure no debris is blocking the bilge pump float. Continuous operation of the bilge can mean a leak or a drain plug is installed incorrectly, make sure all drain plugs are installed. See your Tigé Dealer if you have any questions.

DO NOT allow water to accumulate in the bilge area of your boat. When the boat is in use, check the bilge area often. Your Tigé boat is equipped with an automatic bilge pump which detects excess water accumulation and will turn the bilge pump on automatically. Bilge water normally accumulates from weather, wet water sports gear, getting into your boat from the water and draining coolers.

The engine and other parts of the drive system could be damaged and there is a risk of personal injury as increasing water level will affect the handling and maneuverability of the boat.



CAUTION

The risk of personal injury from excess water in the bilge area will adversely affect the handling and maneuverability of the boat. Also, damage to the engine and other parts of the drive system can occur from the additional water. DO NOT allow the bilge pump to operate after all the water has been cleared from the bilge area. Damage to the pump will occur.

SHOWER SYSTEM

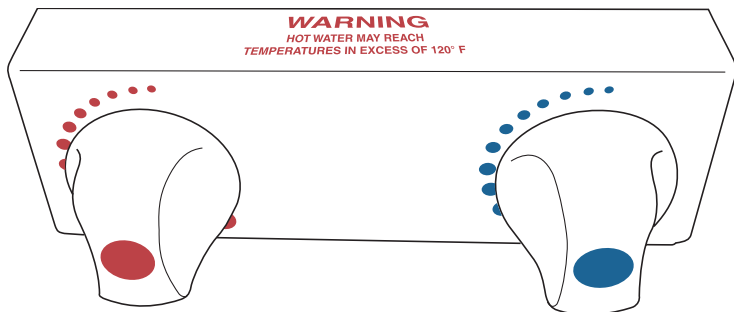

The shower system consists of a pump for water pressure, a “manifold” for cold and hot water, and a five-setting nozzle with an ON/OFF valve.

The hot water is supplied from the residual water from the engine’s cooling system. DO NOT run the engine when using the shower at the boarding platform. If additional hot water is necessary, turn off the shower and warm up the engine for a couple of minutes.

! WARNING

BURN HAZARD
Hot water from the shower may reach temperatures in excess of 120°F (49°C). Use both the cold and hot water control knobs when testing water temperature.

The shower manifold has two water control knobs, one for cold (blue) and one for hot (red). Turn the knobs counterclockwise to increase pressure and control the temperature.

Use the nozzle to turn the water stream on and select the desired setting, SHOWER/FULL/STREAM/FLAT/MIST.

After using the shower, turn off the water control knobs. Relieve the pressure from the shower hose by opening the ON/OFF valve at the nozzle and then closing it.

During off-season storage or below freezing temperatures, the shower system must be winterized. Your Tigé Dealer can assist you with winterization of the shower system.

SCHEMATIC AND SYSTEM ILLUSTRATIONS

The Schematic and System illustrations show models with the maximum components and accessories, which may not be included on your Tigé boat.

! WARNING

CARBON MONOXIDE POISONING OR ROTATING PARTS HAZARD
Poisonous CO gases are present at the rear of the craft when the engine is running. Exposure to CO gases can cause death or serious injury. A rotating propeller can cut or entangle causing death or serious injury. DO NOT use the swim/boarding platform when the engine is running.

Use the swim/boarding platform only for boarding the craft or entering the water.

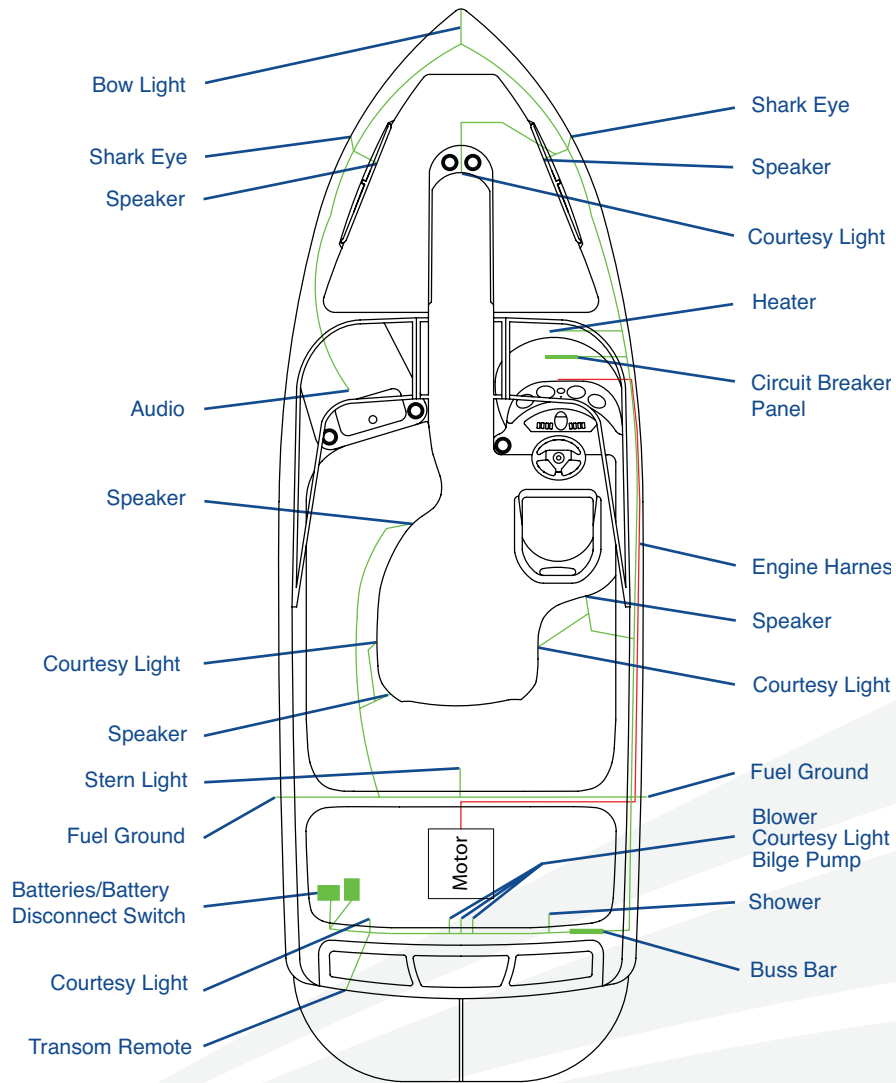

Typical V-Drive Electrical Schematic

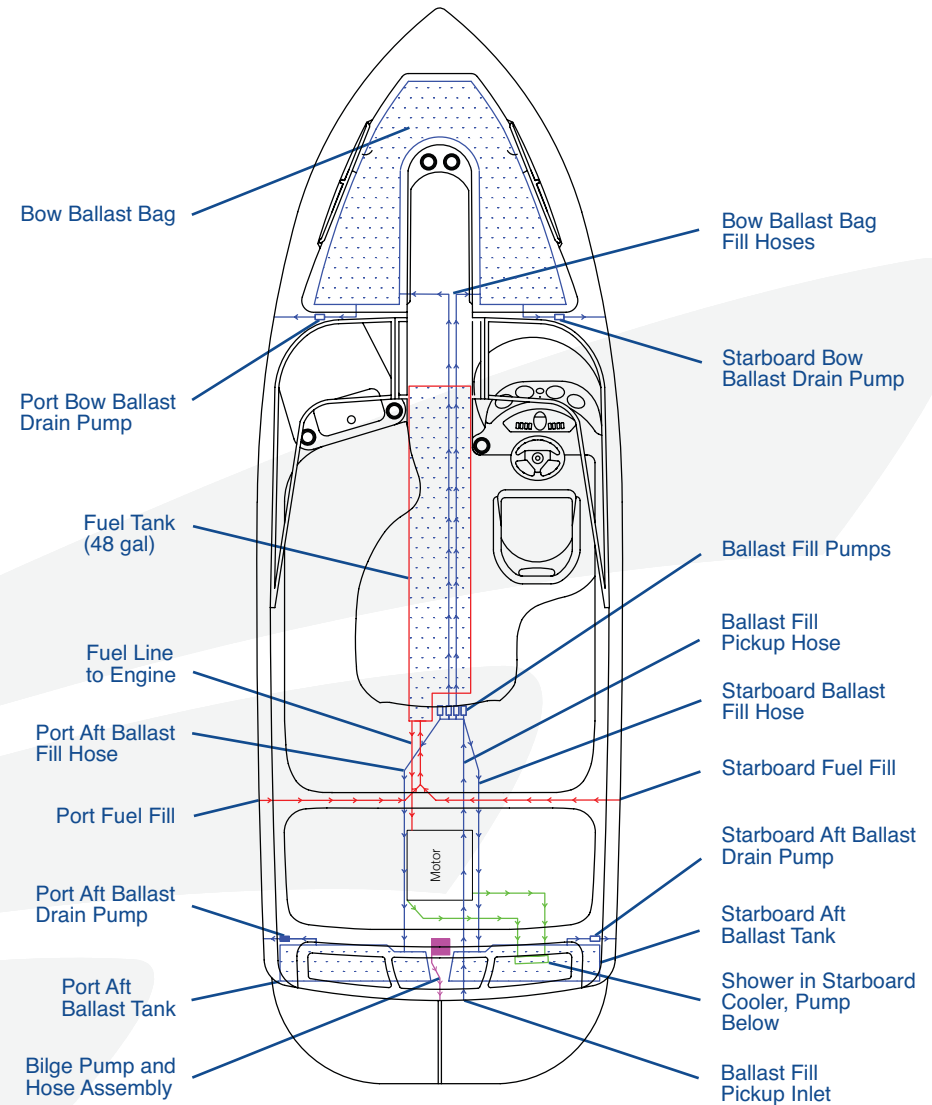

Typical V-Drive Fuel and Water System

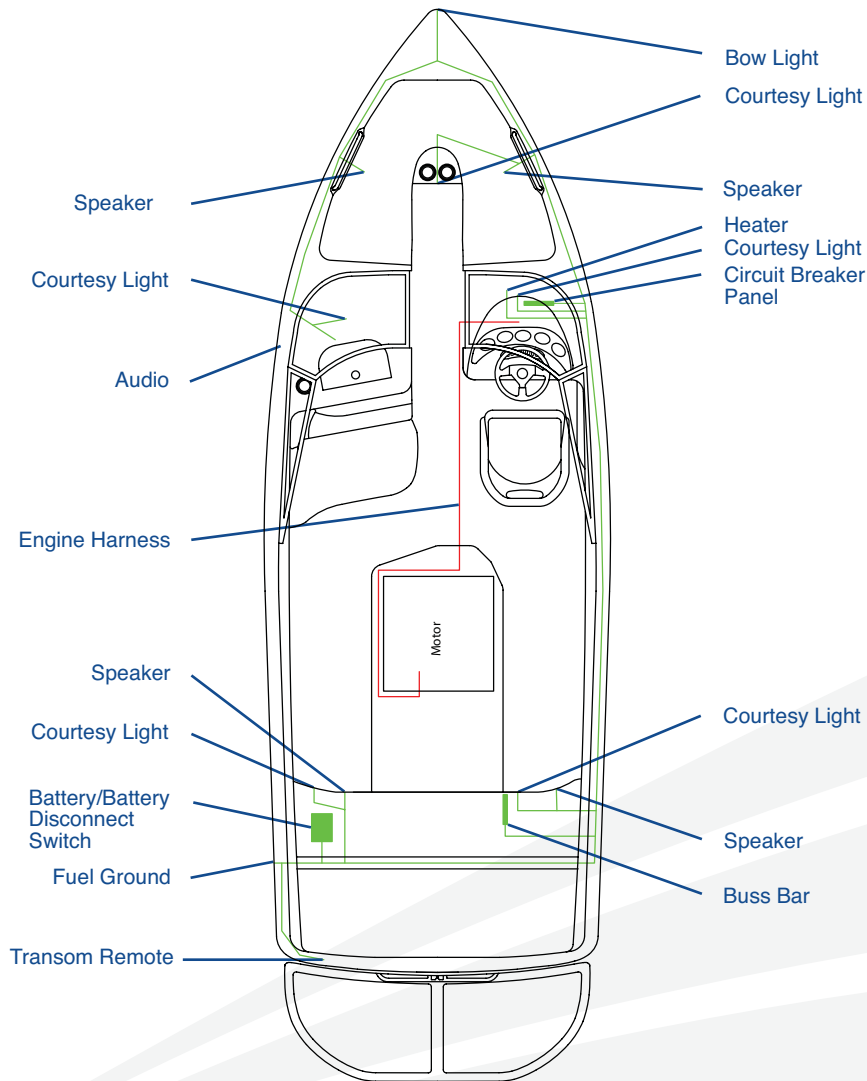

Typical Direct Drive Electrical Schematic

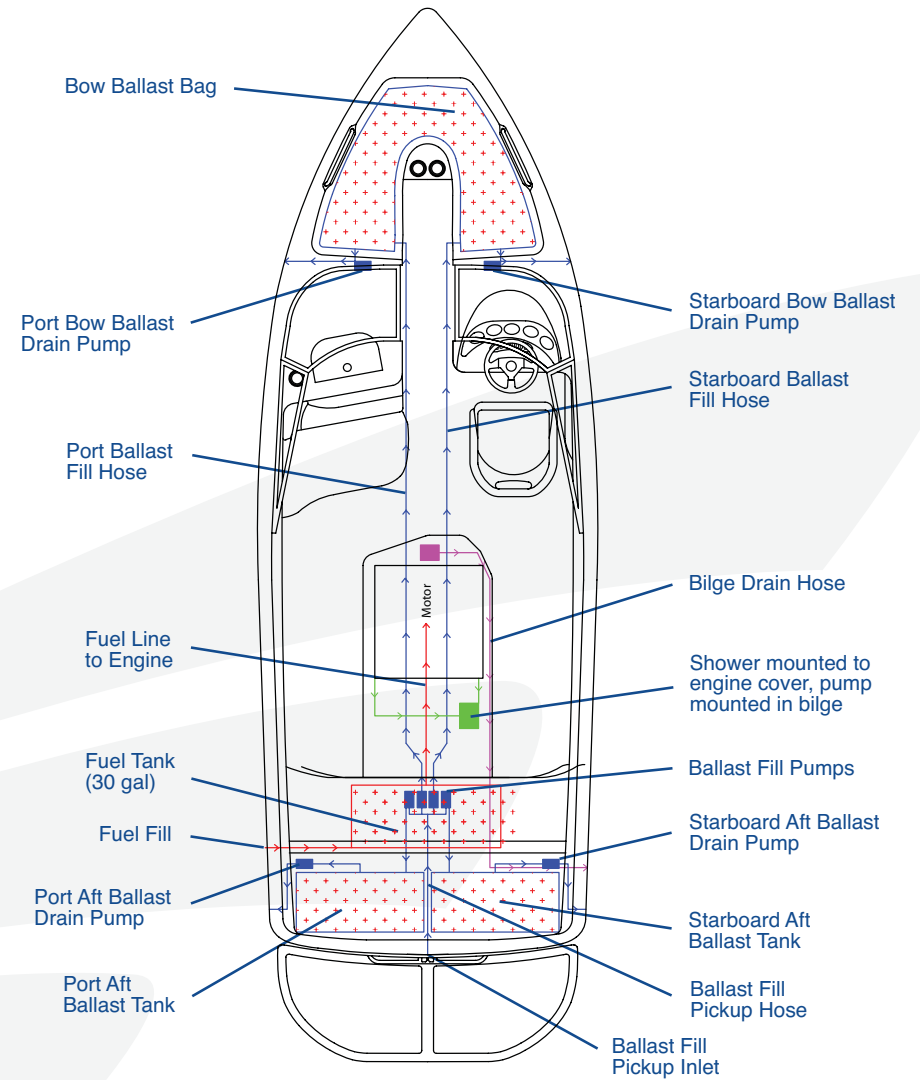

Typical Direct Drive Fuel and Water System

Section 7

CARE AND MAINTENANCE

This section describes how to take care of and maintain your Tigé boat. Periodic inspection and maintenance of items listed in this section are absolutely necessary.

Winterization of major components and some engine maintenance procedures are best performed by your Tigé Dealer. Some maintenance procedures also require special tools which only a dealer may have. Refer to the engine's owner's manual for maintenance information for the engine.

Some maintenance items that can be done by you or your dealer are listed in this section. We suggest that you become familiar with these even if you have your dealer service your boat.





GENERAL MAINTENANCE

1. Read engine owner's manual carefully and completely.
2. Check and make sure all drain plugs are installed correctly everytime you use your boat.
3. Check the fuel system for leaks every time you use your boat.
4. DO NOT start your engine if you smell gasoline or an odor is present. Gasoline fumes are highly explosive. Before starting your engine, always operate the blower for at least four minutes or open the engine cover and inspect the engine compartment for gasoline fumes. Run your blower when operating at slow speeds. If fuel vapors are present, DO NOT start the engine. Check all hoses and fittings to determine the source of the vapor. Make the necessary repairs or take the boat to a qualified service technician to eliminate the fuel vapor.



WARNING

FIRE OR EXPLOSION HAZARD

Fuel vapors are highly explosive when exposed to open flame or spark resulting in death or serious injury. Run blower for at least four minutes before turning on any electrical devices or starting the engine.

5. When servicing the ignition switch or any wiring, disconnect the battery cables from the battery.
6. Check for water circulation when the engine is running.

Exhaust should contain steady flow of water. In closed cooling systems, make sure the coolant in the cooling system is at the proper level.

INTERIOR

The interior fabric of your Tigé boat is designed to take the tough punishment of the elements and usage of an active boater. Keep sharp objects away from the interior to prevent cuts or damage to your interior.

The interior of your Tigé boat can be cleaned easily, over and over, without showing signs of wear. Certain ingredients in products can contribute to staining of your interior, such as sunscreens. Some of these ingredients are:

- Aminobenzoic acids - e.g. PABA
- Hydroxy benzophenones - e.g. Oxybenzone
- P-methoxycinnamic acid - e.g.
- Octylmethoxycinnamate

This list is not inclusive, but does represent a large selection of sunscreens which are known to stain vinyls. Almost any sunscreen with a high percentage (two percent or more) of active ingredients can stain.

The interior manufacturer or Tigé Boats warranties do not cover staining from sunscreens.

Special care should be taken to prevent dark-colored rubber products from coming in contact with your interior upholstery.

NOTICE

It is extremely important to clean the stained area as quickly as possible, making sure the recommended cleaning steps are followed in order.

Care and Cleaning of Interior

Remove ordinary dirt and light smudges with a mild soap and warm water solution. Dry it with a soft, lint-free cloth or towel. For more difficult stains, use a stronger detergent. Follow the detergent manufacturer's instructions closely.



Step-by-step cleaning instructions:

- A** – Medium-soft brush, warm soapy water. Rinse/dry.
- B** – Vinyl Finish Vinyl Cleaner®. Rinse/dry.
- C** – One teaspoon of ammonia, 1/4 cup of hydrogen peroxide and 3/4 cup of water. Rinse/dry.
- D** – Wipe or scrape off excess. (Chill gum with ice.)
- E** – Hemisphere Ink Remover. Rinse/dry.

All cleaning methods must be followed with a thorough rinse with clean warm water.

Type of Stain	Steps:	1	2	3
General care:		A	B	
Foods:				
Chewing gum		D	A	
Chocolate, Coffee, Tea:		B		
Grape juice:		A	C	
Ketchup:		A	B	
Olive oil:		A		
Yellow mustard:		A	B	C
Type of Stain	Steps:	1	2	3
Miscellaneous:				
Ballpoint ink:		E	B	A
Bird droppings:		A	B	
Blood:		A	C	
Dirt buildup:		A	B	
Grease:		D	B	
Hair oil tonic:		A		
Household soil:		A	B	
Latex paint:		A	B	
Lipstick:		A	B	
Mildew or wet leaves:		C	B	A

Motor oil:	B	
Oil base paint:	D	B
Oily spot:	A	B
Permanent marker:	E	B C
Spray paint:	B	
Suntan lotion:	A	B
Tar / asphalt:	D	B
Urine:	A	C

Do's

- 🔥 Vinyl Finish Vinyl Cleaner®
- 🔥 Dish soap, Dawn®, Ivory®
- 🔥 303 Aerospace Protectant

Don'ts

- 🔥 Fantastik™
- 🔥 Formula 409®
- 🔥 Murphy's® Oil Soap
- 🔥 Simple Green®
- 🔥 Armor All®
- 🔥 Sun-of-a-Gun®
- 🔥 Bleach / baking soda®
- 🔥 Turtle® Wax / Tar Remover



WARNING

FIRE, EXPLOSION OR ASPHYXIATION HAZARD!

Vapors from flammable solvents can cause fire, explosion or asphyxiation resulting in death or serious injury. DO NOT use flammable solvents to clean the bilge.

Dark Stowage Areas

When a boat is stored completely covered or in a dark building, the vinyl will darken or become “dingy” looking. If this happens, simply place the boat in direct sunlight for a few hours and the vinyl will brighten up.

BILGE PUMP AND BILGE AREA

Check your bilge pump often to make sure it is functioning properly. The BILGE switch can be used to test the bilge pump, by listening to hear that the pump is operating. It may not pump water unless water is present. The bilge pump is located in the bilge area. Keep it from getting clogged by removing any debris you find in the bilge area. Debris can also block the pump float from functioning or make it operate continuously. Make sure no debris is blocking the bilge pump float.

Wash the bilge with a good biodegradable household detergent or a bilge cleaner available at your Tigé Dealer or a marine supply store. Rinse with water while your bilge pump is running. If your pump seems too slow, remove the top of the pump from the base and check the impeller to make sure there is no debris inside. See your dealer if there is still a problem or you suspect a problem with the pump.

IMPORTANT

DO NOT discharge oil or cleaners into the water. Refer to Section 1, **OUR ENVIRONMENT, Fuel/Oil Spillage**. Bilge pumps and bilge pumping systems are not designed for damage control. Check the function of all bilge pumps at regular intervals. Continuous operation of the bilge can mean a leak or a drain plug installed incorrectly. Make sure all drain plugs are installed. See your Tigé Dealer if you have any questions.

EXTERIOR

Use quality boat care product when protecting the exterior of your Tigé boat. The exterior of your boat is as important as protecting the engine. A little effort today will keep your boat looking good in the future and show the pride every time you use your boat.



WARNING

FIRE/EXPLOSION/ASPHYXIATION HAZARD

Cleaning agents and paint ingredients can be flammable and/or explosive, or dangerous to inhale. Make sure ventilation is adequate, wear proper personal protection and dispose of rags properly ashore.

Vapors from flammable solvents can cause fire, explosion or asphyxiation resulting in death or serious injury. Keep open flame or spark away from work area. **DO NOT** paint unless in a well-ventilated area.



WARNING

SLIPPERY SURFACE HAZARD

Cleaning craft surfaces can generate slippery conditions which can result in death or serious injury. Use caution when cleaning with detergents and rinse thoroughly.

GELCOAT MAINTENANCE

Regular maintenance will keep your exterior surfaces in good condition. Exposure to the sun, sand, sap or staining properties from trees and minerals in the water affect your boat's finish.

To help maintain the shine of your boat, wash the hull with a mild biodegradable detergent after each use to help to remove any debris and waterborne materials. Use a soft sponge or towel and dry with a chamois cloth to prevent water spots.

Wax the hull sides and deck regularly with a high-quality wax. Waxes and polishes can be obtained from your Tigé Dealer or a marine supply store. Always follow the directions of the manufacturer of these products before you use them.

In certain areas, sudden changes in temperature can affect gelcoat. When planning on moving your boat from outdoors to a heated location, allow the change of temperature to be gradual. Heat the location after the boat is brought inside to allow the boat to change temperature slowly as the location is heated. Also, if you are planning on moving your boat from a warmer area to a colder one, wait for the outside temperature to be closer to the warmer area's temperature or allow the warmer area and the boat to cool down before moving your boat.

If your boat's gelcoat develops a chalky look over a period of time due to exposure to sun, there are gelcoat buffing and polishing compounds available from your Tigé Dealer or a marine supply store. DO NOT use common household scouring pads or powders.

The hull bottom is also an important area to keep clean since buildup of water scum and algae will reduce the boat's efficiency. If you leave your boat in the water, compounds to remove algae buildup on your hull are available. Use care when choosing these products since some can be caustic. Pay special attention to the cautions on the labels of these coatings. Ask your Tigé Dealer for advice on which products work best in your area.

Deck and Hull

The finish on your Tigé boat is known as gelcoat. Our gelcoat and lamination processes are among the finest available. Even though we take all the precautions during manufacturing, the finish on your boat is susceptible to the elements and many types of water conditions.

Cleaning Deck and Hull

A multipurpose boat soap* should be used to clean exterior fiberglass/gelcoat surfaces on your Tigé boat after each use. This product, depending upon the ratio mixed, is designed to clean anything from dirty hulls and decks to greasy engines. Always rinse and wipe off the finish with a damp towel or chamois.

A fiberglass restorer/wax* should be used to remove heavy oxidation, rust and exhaust stains. This product will not only restore the look but will also leave a wax protection on the cleaned surface.

Deck and Hull Care

Paste wax* will help protect against UV light damage. A coat should be applied at the beginning, middle and end of the boating season.

To extend the life of your gelcoat finish, use a Tigé marine mooring cover to cover the top deck of the boat for maximum protection. If your boat is to be stored where the sun is constantly on the side or transom of the boat, you should consider protecting those surfaces.

Tonneau covers will supply adequate short-term protection to the interior, but will not protect the gelcoat finish.

*3M and your Tigé Dealer carry a complete line of fiberglass care products.

STAINLESS STEEL AND CHROME

Stainless steel is highly resistant to marine environments, but is still capable of rusting. Signs of rust and corrosion when left untreated can result in permanent damage. You can keep your stainless steel looking new by cleaning monthly with a good quality stainless steel cleaner or polish. Clean and polish in the direction of the grain or finish.

Clean and wax metal prior to extended storage. In saltwater or other harsh environments, clean and wax more often. High-quality stainless steel cleaners and conditioners are commercially available. Rinse with fresh water and wipe dry with towel or chamois after each use.

Cleaning Stainless Steel

If rust or corrosion does appear use a good metal cleaner/polish immediately to protect from permanent damage. **DO NOT use steel wool or other coarse abrasives, or clean with citrus cleaners, acids or bleach. DO NOT use cleaners that are not for use on stainless steel, such as glass, tile or counter cleaners.** These types of cleaners can damage the surface permanently. Apply metal or automotive wax after cleaning for additional protection. Always test any product in an inconspicuous area before applying to the complete surface.

If you have to replace hardware or fasteners, make sure the replacement components are made of the correct materials. See your Tigé Dealer if you have any questions.

DO NOT store soiled rags onboard. Store or dispose of rags properly ashore.

NOTICE

Use caution in cleaning around stitching, wood or other decorative trim, since solvents could seriously damage these materials.

TEAK SWIM PLATFORM

If your Tigé boat is equipped with a teak swim platform, keep the teak in top condition by cleaning it with a teak cleaner occasionally and re-oiling it at least once a season. Follow the manufacturer's instructions and warnings carefully. Some cleaners and oils can damage gelcoat, vinyl, stainless and aluminum. DO NOT use steel wool pads when cleaning.

NOTICE

Teak sealers and cleaners can be harmful to other materials. Thoroughly clean up any spills or excess. DO NOT varnish teak. The natural oils in teak will prevent adhesion.

PROPELLER



WARNING

CUT HAZARD

A propeller can be sharp and can cause death or serious injury. Wear a pair of protective gloves when handling any propeller. Prevent accidental starting of the engine by:

- Removing key from the ignition.
- Removing emergency stop switch clip from the switch.

DO NOT reuse the nylon locknut or the cotter pin, or use a damaged propeller. A damaged propeller can damage your engine and boat.

To remove:

1. Remove the cotter pin from the propeller shaft and discard.
2. Wedge a piece of 1" x 4" wood between the propeller blade and the port side of the strut and rudder.
3. Remove the nylon locknut and discard.

Use a propeller puller to remove the propeller and then remove the key from the keyway. Make sure the keyway in the propeller and on the shaft are free of any damage.

To install:

Look at the keyway on the shaft and in the propeller and make sure the key slides freely in the propeller keyway and shaft keyway. If the key has burrs, remove them by filing the flat sides or replace the key. DO NOT file the key beyond its normal shape or size.

1. Rotate the shaft until the keyway is up.
2. Place the key in the shaft keyway. Rotate the propeller so the keyway in the propeller is aligned with the keyway on the shaft. The propeller will only slip on in one direction. Once everything is aligned, push the propeller solidly onto the shaft and make sure the propeller is seated.
3. Wedge a piece of 1" x 4" wood between the propeller blade and the starboard side of the strut and rudder.
4. Install a new nylon locknut and torque the nut to maximum of 30 ft-lbs (40.7 N·m).
5. Install a new cotter pin and bend the retaining ends of the cotter pin in opposite directions.

SALTWATER BOATING

NOTICE

If you use your boat in salt water or other unusual water conditions, freshwater flushing is recommended for your engine and the cooling system.

Tigé offers an optional freshwater flush kit. The Tigé freshwater flush kit has a relief valve to prevent excess water pressure to your engine. Excess water pressure can damage the engine. This is the only system Tigé recommends. Running the boat in fresh water is another good way to flush the engine, but it must be done immediately.

BATTERY MAINTENANCE



WARNING

FIRE/EXPLOSION HAZARD

Explosion or fire from hydrogen gases produced by lead acid batteries will cause death or serious injury.

- Wear personal protective equipment when working on or around batteries.
- **DO NOT** charge or use a battery booster to start your engine.
- Charge the battery outside of the craft.
- **DO NOT** smoke or bring a flame near a battery.
- **DO NOT** have your head directly above a battery when making or breaking electrical connections.
- If ignited by a spark or flame gas may explode violently, causing spraying of battery acid or fragmentation of the battery.
- **DO NOT** use a metal object to spark between battery posts to check if the battery is charged.

Use care when connecting or disconnecting a battery charger. Make sure the charger is turned OFF and unplugged from power source when you clip ON/OFF the connecting clamps.

Make sure the connection is solid with the charging clamps.

Poor connections are common causes of electrical arcs, engine problems and errant signals to the engine's ECM.

DO NOT make or break electrical circuits at the battery terminals; a spark will occur when a circuit is live and opened or made. Turn off all components.

Use a voltmeter or hydrometer to check the battery charge condition.

Remove the battery cables from the battery when the boat is placed in storage, on display or in transit, to eliminate the possibility of the engine accidentally starting without a supply of cooling water.

The battery and cables are identified:

+ = red positive

– = black negative

To clean your battery, remove and wash down the battery case with a diluted ammonia or baking soda/water solution to neutralize the acid, then flush with fresh water. Keep the fill/vent caps tight so the neutralizing solution does not get into the battery cells.

The electrolyte level should be checked every 30 days. Use distilled water only if any water is required. Maintain the level between the top of the plates and the bottom of the fill/vent cap. **DO NOT** overfill. Batteries contain sulfuric acid which can cause severe burns.

TRANSMISSION OIL LEVEL INSPECTION

Check the oil with the boat level and the engine off.

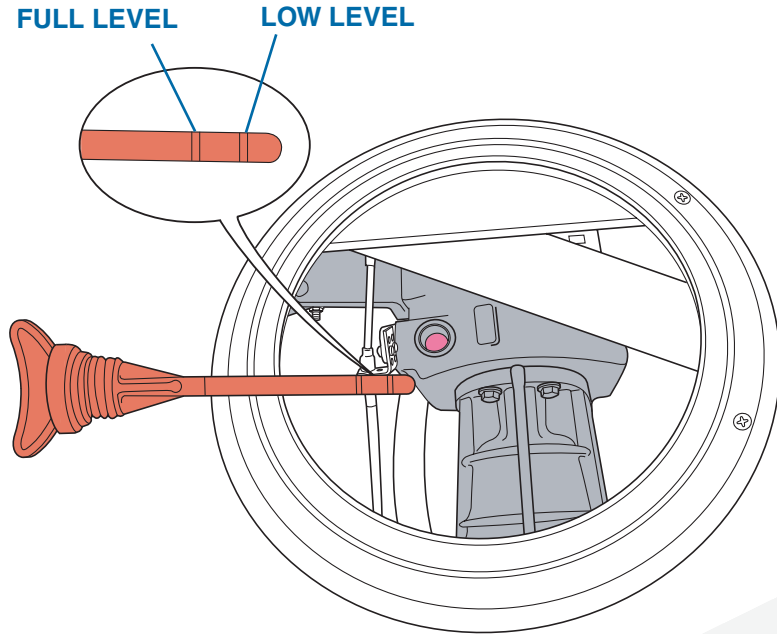

V-Drive

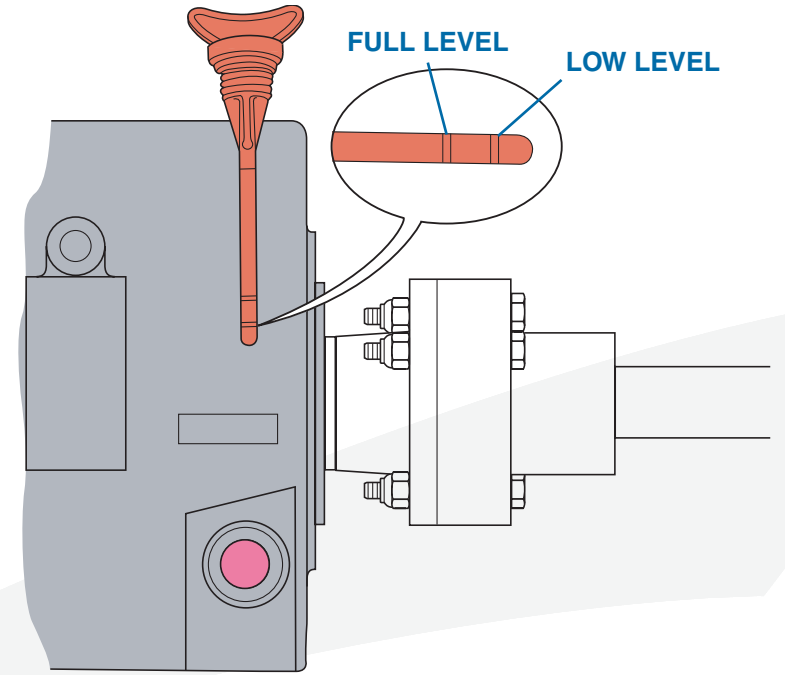

Direct Drive

Remove the oil level dipstick. The oil level should be between the “FULL LEVEL” and the “LOW LEVEL” indicator marks on the dipstick.

Verify the oil level with the gauge fully inserted into the transmission housing. DO NOT overfill. Use fresh recommended fluid only. To add or fill, use the dipstick opening. Refer to the transmission owner’s manual for type of fluid, changing fluid intervals and more detailed information.

STEERING

All steering systems require periodic maintenance to be trouble-free and safe. Check steering operation and visually inspect for loose or missing hardware before operating the craft. If you suspect the steering system is damaged, see your dealer.



WARNING

LOSS OF CONTROL AND UNSAFE BOAT HAZARD

Improper maintenance of steering system is hazardous and can cause death or serious injury from sudden loss of control. Make sure all steering hardware, cables and fluid levels are regularly inspected and maintained.

UNSCHEDULED MAINTENANCE

A problem with any electrical or mechanical equipment can occur anytime. Be aware of a malfunction if one occurs, or if you suspect a problem. Have the problem serviced immediately by your Tigé Dealer.

Engine/Propulsion/Cooling System

If a problem occurs with your engine, propulsion unit or the cooling system between the scheduled maintenance cycle, immediately notify your Tigé Dealer to have the problem resolved. DO NOT allow a problem to go unattended.

Electrical System

Have your Tigé Dealer repair all electrical problems. Electrical problems must be treated seriously and repaired immediately. Whenever checking for electrical problems, use extreme caution. Fuel and fumes are extremely flammable and explosive.



WARNING

FIRE OR EXPLOSION HAZARD

An AC/DC can create sparks. In the presence of explosive gases, fire or explosion can occur. Check for explosive gases or run the blower.

DO NOT work on an energized system. Turn the battery disconnect switch OFF.

Fuel System

DO NOT operate your boat if you know you have a fuel system problem. When you discover or suspect a fuel system problem, immediately notify your Tigé Dealer for repair.



WARNING

FIRE OR EXPLOSION HAZARD

Fuels are extremely flammable and highly explosive under certain conditions. DO NOT smoke or allow open flame or sparks nearby when inspecting the fuel system.



Shower System

The shower system must be filled with the proper storage antifreeze or drained completely for winter storage. If antifreeze is added to the engine cooling system, the shower must be included. After the system is drained or filled with antifreeze, the two water control knobs and the nozzle must be left open.

Cockpit Heater

The cockpit heater must be filled with the proper storage antifreeze or drained completely for winter storage. If antifreeze is added to the engine cooling system, the heater must be included.

SLINGING/LIFTING THE BOAT

To prevent structural damage to your Tigé boat, the proper procedure must be used when lifting your boat. Only use appropriate style lifting slings or lift rings with a spreader bar. Protect the rub rail to prevent any part of the lift device from making contact with the boat. On the RZ2 model, the swim platform must be removed if lift rings are used.

If the boat is to be removed from the water without a trailer, follow these guidelines:

- Never attach lifting cables to cleats, ski tow eyes or handrails. Attach cables only to the bow and stern eyes.
- Cover lifting cables with rubber hose or other protectors to prevent damage to the finish.
- Attach guide lines to the bow and stern to control movement.
- Use spreader bars and keep lifting pressure vertical to prevent gunwale damage.
- Keep the bow slightly higher than the stern to prevent engine damage.

Using Lifting Slings

This method should only be used by a qualified person with knowledge on how to use lifting slings, or your Tigé Dealer. Slings must be the flat, wide-belted type. DO NOT use cable-type slings.

The spreader bars used with the slings must be wide enough to avoid pressure to the gunwales.

Contact your Tigé Dealer to identify the proper location for slings. Slings may need to be adjusted fore or aft for your particular boat.

Storage Cradle

If you are planning on storing your Tigé boat on a cradle, only use a storage cradle. You may also use the trailer designed for your boat to store your boat when it is not in the water. A storage cradle or your boat's trailer will provide proper support and prevent stress on the hull.

Position the storage cradle as close to the sling locations as possible. Use caution not to damage any underwater components.

The storage cradle must completely touch the hull for proper support. Be sure there are no gaps between the cradle and the hull. Store your boat with the bow slightly elevated to the same attitude as if the boat were floating. If the boat is stored with the bow down, moisture cannot move to the engine bilge area and out of the boat. Remove the transom drain plug.

Make sure all compartments in the bilge area completely drain. Mold and mildew can form as a result of moisture.

After the boat has been properly positioned on a storage cradle, thoroughly wash the interior, hull, deck and interior compartments. Allow a couple of days of air drying before covering the boat, store all cushions in the open position and open all storage areas to help prevent mold/mildew.

Cover the boat with the storage cover. If a temporary poly cover such as shrink wrap is used, your Tigé Dealer will install vents to provide ventilation to help prevent mold or mildew.



STORAGE/WINTERIZATION

Preparing for winter lay-up is important. In frigid zones, be particularly attentive to items that can be damaged by freezing. Damage to your boat from improper storage is not covered by the warranty.

Without proper preparation, storage for long periods of time can cause internal parts of the engine and drive system to rust because of lack of lubrication. Or, if the boat is stored in below freezing temperatures, water inside the bilge or cooling system can freeze, causing damage. The following procedures should help prevent damage to your boat.

Perform all annual maintenance at this time.

The following items require special attention for winterization. Your Tigé boat may not include all the features described. Have your Tigé Dealer perform winterization procedures for the following:

- 🚩 Engine cooling and exhaust systems
- 🚩 Fuel system
- 🚩 Batteries
- 🚩 Cockpit heater
- 🚩 Drain Ballast System

Storage Preparation

While the boat is still in the water:

1. Fill fuel tank and add the proper amount of fuel stabilizer and conditioner according to the engine manufacturer's recommendations.
2. Operate boat for at least 15 minutes to be sure the treated fuel has reached the engine.

NOTICE

If the boat is to be stored for more than five months, stored in a high-moisture (humidity) environment, in temperature extremes or outdoors, "fog" the engine with a rust-preventive fogging oil according to the manufacturer's recommendations. See your Tigé Dealer.

When the boat is removed from the water:

NOTICE

Remove the bilge drain plug immediately after taking the boat out of the water. After washing, raise the bow of the boat high to allow as much water as possible to drain while performing other storage preparations.

- 🚩 Flush the engine cooling system with clean fresh water. DO NOT exceed 1500 RPM when flushing.

- ✦ Drain the ballast tank system.

IMPORTANT

It is extremely important to drain ballast system during freezing temperatures and during long periods of non-use. Protect our natural resources by using environmentally friendly products and always discard in an environmentally friendly manner.

1. Drain the system completely after your boat is out of the water and keep the intake/drain valves open.
 2. Use a 50/50 mixture of an environmentally friendly antifreeze and fresh water.
 3. Pour an even amount, approximately 1 gallon (3,8 liters) of the antifreeze mixture into each tank's vent.
 4. Make sure you catch any spilled mixture by placing a container under the intake/drain of the tank you are winterizing.
 5. Operate the pump in the drain mode for two seconds; then shut off. Repeat procedure for other tank(s).
 6. Close the water intake/drain valves in the ballast tank(s). When returning your boat back to service, make sure to drain the remainder of the mixture before getting onto the water.
- ✦ Thoroughly wash the interior, interior compartments, deck and hull as soon as your boat is removed from the water. Cleaning the hull at this time is easier because the marine growth is still wet. Allow a couple of days of air drying before covering the boat. Store all cushions in the open position and open all storage areas to help prevent mold/mildew.
 - ✦ Apply a coat of wax to the entire surface of the boat and rust inhibitor on all metal parts.
 - ✦ Clean all traces of dirt, oil, grime and grease from the engine and bilge. Touch up areas of engine where paint has been removed.

- ✦ Prepare the engine for storage according to the instructions contained in the engine owner's manual.
- ✦ Store the bilge drain plug and any other drain plugs removed in a plastic bag and tape it to the throttle control lever or near the dash so it is easy to find after being stored.
- ✦ Remove the battery from the boat. Clean, fully charge and store the battery in an area not subject to freezing temperatures or directly on cement. DO NOT store batteries close to heat, spark or flame-producing devices.
- ✦ Repack trailer wheel bearings with water-resistant wheel bearing grease. If the trailer is equipped with bearing protectors, apply grease into hubs with a grease gun.
- ✦ Park trailer and boat in a protected area on cement if possible. If your boat and trailer are left outside, install a boat cover. Cover the boat with the storage cover. If a temporary poly cover such as shrink wrap is used, your Tigé Dealer will install vents to provide ventilation to help prevent mold or mildew.
- ✦ Loosen tie-downs and winch line, but make sure the boat is resting properly on hull supports.
- ✦ Jack up trailer and place blocks under trailer frame to relieve weight on trailer tires and springs.

NOTICE

DO NOT use your tonneau cover or bimini top for long-term storage. These are not designed for long-term storage and do not provide good protection. Adequate ventilation is not possible and mold/mildew will form. For more information on appropriate covering for long-term storage, see your Tigé Dealer.



What to do after Boat Storage

Have your Tigé Dealer prepare your boat for the next boating season. It is very important for the fuel system and exhaust system to be thoroughly inspected and repaired, if necessary, before operating the boat.

There are many steps required to ensure your boat is in proper operating condition. Avoid the risk of fire or explosion. Inspect the fuel system. Failure to inspect the fuel system and allow fuel leaks to go undetected will contribute to a fire or explosion hazard.

If your swim platform was removed for storage, reinstall it. The removable feature is for boat storage only. The boarding ladder is attached to the boarding platform and the boat must not be operated without the swim platform and boarding ladder.



WARNING

FIRE OR EXPLOSION HAZARD

Fuels are extremely flammable and highly explosive under certain conditions. **DO NOT** smoke or allow open flame or sparks nearby when inspecting the fuel system.

Make sure these steps are followed before using your boat:

- Check and inspect the fuel and exhaust systems, the engine cooling and lubrication systems.
- If the swim platform was removed for storage, reinstall it.
- Charge and reinstall battery into boat.
- Check engine and bilge for signs of nesting animals; clean as necessary.
- Check entire engine for cracks and leaks caused by freeze damage.
- Check hose condition and all hose clamps for tightness.
- Install bilge drain plug or any other drain plugs removed. Make sure all plugs are installed correctly.
- Perform daily maintenance. If not performed during lay-up, perform annual maintenance.
- Check and lubricate steering system.
- Remove blocks from under trailer frame.
- Tighten tie-downs and trailer winch line.
- Check tire pressure and lug nuts on trailer.
- Take the boat to the water and start it. It may take a minute of cranking to allow the fuel system to prime. Allow a one-minute cooldown period for every 15 seconds of cranking. When the engine starts, keep a close watch over the gauge readings, and check for leakage and abnormal noises. Keep speeds low for the first 15 minutes until the engine has reached normal operating temperature.





Section 8

TROUBLESHOOTING AND SERVICE REQUIREMENTS

TROUBLESHOOTING

The following chart will assist you in finding and correcting minor problems with your Tigé boat. Refer to your engine owner's manual for more detailed information concerning a problem starting, shifting or operating the engine. Some problems may require the skills of a trained technician and special service tools. Contact your Tigé Dealer for assistance.

Engine Symptom	Possible Cause
Engine will not crank	<p>Ignition safety switch not in place. Install ignition safety switch.</p> <p>Battery disconnect switch located in engine compartment is off. Turn switch ON.</p> <p>MAIN switch on breaker box located under dash is off. Turn switch ON.</p> <p>Circuit breaker is tripped. Run fingers over breaker face and reset any tripped circuit breakers.</p> <p>Bad starter connections. Check connections and tighten. If starter solenoid clicks when attempting to start engine, check battery connections. If condition persists, contact your Tigé Dealer.</p> <p>Engine circuit breaker open. Make sure breaker is in operating position.</p> <p>Faulty ignition switch or engine problem. See your Tigé Dealer.</p> <p>Shift position not in NEUTRAL. Make sure shifter is NEUTRAL.</p> <p>Starting procedure not followed.</p>

TROUBLESHOOTING AND SERVICE REQUIREMENTS

Engine Symptom	Possible Cause
Low starter speed Engine cranks but will not start	Weak or bad battery. See your Tigé Dealer. Fuel level low or empty. Add fuel. Contaminated fuel. See your Tigé Dealer.
Engine runs erratically	Contaminated fuel. See your Tigé Dealer.
Engine vibrates	Propeller damaged. Check for bent, broken or damaged propeller, misaligned propeller shaft, or weeds on propeller.
Engine runs but boat makes little or no progress	Fouled or damaged propeller. Check for weeds on propeller, bent or broken propeller, or contaminated fuel. See your Tigé Dealer.
Performance loss	Throttles not fully open. Make sure throttle opens fully at engines. Improper fuel. Fill tank with correct fuel.
Engine overheating	Turn off engine immediately. Contact your Tigé Dealer. Boat overloaded. Reduce load or distribute boat load evenly. Improper propeller selection. See your Tigé Dealer. Excessive bilge water. Check for excessive water. Drain bilge. Boat hull buildup or blocked water pick-up. Clean if marine growth is present. Saltwater Flush Kit shut-off valve (if equipped), or water pickup seacock (seacock applies to all models sold in Canada), is CLOSED. Open shut-off valve or seacock (handle in-line [OPEN] with hose, not perpendicular [CLOSED]).

Electrical	Possible Cause
Electrical problem	Battery disconnect switch located in engine compartment is off. Turn switch ON. MAIN switch on breaker box located under dash is off. Turn switch ON. Circuit breaker is tripped. Run fingers over breaker face and reset any tripped circuit breakers. Loose wiring connection. Check connections. Defective switch or gauge. See your Tigé Dealer. Dim or no lights, circuit breaker tripped or in OFF position. Check breaker. Battery discharged. Charge battery.
Steering	
Steering problem	Corroded steering cable or worn rudder. See your Tigé Dealer.
Throttle/Shifting	
Throttle/shifting problems	Low transmission fluid level. Check level. Corroded cables, defective throttle return spring or sticking transmission shift lever. See your Tigé Dealer.

SERVICE REQUIREMENTS

20-HOUR SERVICE REQUIREMENTS

Boat # _____

This service must be performed to keep warranty active. Please see your dealer.

Tigé Maintenance Schedule

	DAILY	WEEKLY	REGULAR	ANNUAL	20 HRS.
Smell bilge area for fuel vapors	X	X	X	X	X
Check and tighten all steering system bolts and connections					X
Check rudder, tiller arm bolt and safety setscrew					X
Lubricate rudder stuffing box and steering support tube					X
Lubricate cables					X
Replace cables	If stiffness continues after lubricating				
Check bilge pump operation	X	X	X		X
Check blower operation	X	X	X		X
Adjust and tighten throttle linkage					X
Inspect shaft packing			X		X
Check shaft alignment/ensure it is within .003					X
Check and tighten motor mounts					X
Tighten pylon and tower mounting bolts	X	X	X		X
Tighten all hardware and fasteners					X
Oil teak swim platform (as needed)					X
Change engine oil and filter					X
Change fuel water separator					X
Change transmission fluid					X
Check engine oil	X				
Check transmission		X			
Check water pickups for debris or marine growth		X			
If equipped with a strainer, check and clean		X			
If operated in salt water, flush engine/cooling system and boat	X			X	

IF PROPELLER STRIKES AN OBJECT, INSPECT DRIVE TRAIN IMMEDIATELY!

I certify that the 20-Hour Service has been conducted and a copy will be sent to:

**Tigé Boats, Inc.,
1801 Hwy. 36
Abilene, TX, 79602**

Place Stamp Here

Signature of Mechanic

Date

75-HOUR SERVICE REQUIREMENTS

Boat # _____

This service must be performed to keep warranty active. Please see your dealer.

Tigé Maintenance Schedule

	DAILY	WEEKLY	REGULAR	ANNUAL	75 HRS.
Smell bilge area for fuel vapors	X	X	X		X
Check and tighten all steering system bolts and connections					X
Check rudder, tiller arm bolt and safety setscrew					X
Lubricate rudder stuffing box and steering support tube					X
Lubricate cables					
Replace cables	If stiffness continues after lubricating				
Check bilge pump operation	X	X	X		X
Check blower operation	X	X	X		X
Adjust and tighten throttle linkage					X
Inspect shaft packing			X		X
Check shaft alignment/ensure it is within .003					X
Check and tighten motor mounts					X
Tighten pylon and tower mounting bolts	X	X	X		X
Tighten all hardware and fasteners					X
Oil teak swim platform (as needed)					X
Change engine oil and filter (every 100 hrs. or annually)				X	
Change fuel water separator (every 100 hrs. or annually)				X	
Change transmission fluid (every 100 hrs. or annually)				X	
Check engine oil	X				
Check transmission		X			
Check water pickups for debris or marine growth		X			X
If equipped with a strainer, check and clean		X			X
If operated in salt water, flush engine/cooling system and boat	X				

IF PROPELLER STRIKES AN OBJECT, INSPECT DRIVE TRAIN IMMEDIATELY!

I certify that the 75-Hour Service has been conducted and a copy will be sent to:

**Tigé Boats, Inc.,
1801 Hwy. 36
Abilene, TX, 79602**

Place Stamp Here

Signature of Mechanic

Date

TROUBLESHOOTING AND SERVICE REQUIREMENTS

150-HOUR SERVICE REQUIREMENTS

Boat # _____

This service must be performed to keep warranty active. Please see your dealer.

Tigé Maintenance Schedule	DAILY	WEEKLY	REGULAR	ANNUAL	150 HRS.
Smell bilge area for fuel vapors	X	X	X		X
Check and tighten all steering system bolts and connections					X
Check rudder, tiller arm bolt and safety setscrew					X
Lubricate rudder stuffing box and steering support tube					X
Lubricate cables					X
Replace cables	If stiffness continues after lubricating				
Check bilge pump operation	X	X	X		X
Check blower operation	X	X	X		X
Adjust and tighten throttle linkage					X
Inspect shaft packing			X		X
Check shaft alignment/ensure it is within .003					X
Check and tighten motor mounts					X
Tighten pylon and tower mounting bolts	X	X	X		X
Tighten all hardware and fasteners					X
Oil teak swim platform (as needed)					X
Change engine oil and filter (every 100 hrs. or annually)				X	
Change fuel water separator (every 100 hrs. or annually)				X	
Change transmission fluid (every 100 hrs. or annually)				X	
Check engine oil	X				
Check transmission		X			
Check water pickups for debris or marine growth		X			
If equipped with a strainer, check and clean		X			
If operated in salt water, flush engine/cooling system and boat	X				

IF PROPELLER STRIKES AN OBJECT, INSPECT DRIVE TRAIN IMMEDIATELY!

I certify that the 150-Hour Service has been conducted and a copy will be sent to: **Tigé Boats, Inc.,**
1801 Hwy. 36
Abilene, TX, 79602

Place Stamp Here

Signature of Mechanic

Date

225-HOUR SERVICE REQUIREMENTS

Boat # _____

This service must be performed to keep warranty active. Please see your dealer.

Tigé Maintenance Schedule	DAILY	WEEKLY	REGULAR	ANNUAL	225 HRS.
Smell bilge area for fuel vapors	X	X	X		X
Check and tighten all steering system bolts and connections					X
Check rudder, tiller arm bolt and safety setscrew					X
Lubricate rudder stuffing box and steering support tube					X
Lubricate cables					X
Replace cables	If stiffness continues after lubricating				
Check bilge pump operation	X	X	X		X
Check blower operation	X	X	X		X
Adjust and tighten throttle linkage					X
Inspect shaft packing			X		X
Check shaft alignment/ensure it is within .003					X
Check and tighten motor mounts					X
Tighten pylon and tower mounting bolts	X	X	X		X
Tighten all hardware and fasteners					X
Oil teak swim platform (as needed)					X
Change engine oil and filter (every 100 hrs. or annually)				X	
Change fuel water separator (every 100 hrs. or annually)				X	
Change transmission fluid (every 100 hrs. or annually)				X	
Check engine oil	X				
Check transmission		X			
Check water pickups for debris or marine growth		X			
If equipped with a strainer, check and clean		X			
If operated in salt water, flush engine/cooling system and boat	X				

IF PROPELLER STRIKES AN OBJECT, INSPECT DRIVE TRAIN IMMEDIATELY!

I certify that the 225-Hour Service has been conducted and a copy will be sent to: **Tigé Boats, Inc.,**
1801 Hwy. 36
Abilene, TX, 79602

Place Stamp Here

Signature of Mechanic

Date

TROUBLESHOOTING AND SERVICE REQUIREMENTS

300-HOUR SERVICE REQUIREMENTS

Boat # _____

This service must be performed to keep warranty active. Please see your dealer.

Tigé Maintenance Schedule	DAILY	WEEKLY	REGULAR	ANNUAL	300 HRS.
Smell bilge area for fuel vapors	X	X	X		X
Check and tighten all steering system bolts and connections					X
Check rudder, tiller arm bolt and safety setscrew					X
Lubricate rudder stuffing box and steering support tube					X
Lubricate cables					X
Replace cables	If stiffness continues after lubricating				
Check bilge pump operation	X	X	X		X
Check blower operation	X	X	X		X
Adjust and tighten throttle linkage					X
Inspect shaft packing			X		X
Check shaft alignment/ensure it is within .003					X
Check and tighten motor mounts					X
Tighten pylon and tower mounting bolts	X	X	X		X
Tighten all hardware and fasteners					X
Oil teak swim platform (as needed)					X
Change engine oil and filter (every 100 hrs. or annually)				X	X
Change fuel water separator (every 100 hrs. or annually)				X	X
Change transmission fluid (every 100 hrs. or annually)				X	X
Check engine oil	X				
Check transmission		X			
Check water pickups for debris or marine growth		X			
If equipped with a strainer, check and clean		X			
If operated in salt water, flush engine/cooling system and boat		X			

IF PROPELLER STRIKES AN OBJECT, INSPECT DRIVE TRAIN IMMEDIATELY!

I certify that the 300-Hour Service has been conducted and a copy will be sent to: **Tigé Boats, Inc.,
1801 Hwy. 36
Abilene, TX, 79602**

Place Stamp Here

Signature of Mechanic

Date

400-HOUR SERVICE REQUIREMENTS

Boat # _____

This service must be performed to keep warranty active. Please see your dealer.

Tigé Maintenance Schedule	DAILY	WEEKLY	REGULAR	ANNUAL	400 HRS.
Smell bilge area for fuel vapors	X	X	X		X
Check and tighten all steering system bolts and connections					X
Check rudder, tiller arm bolt and safety setscrew					X
Lubricate rudder stuffing box and steering support tube					X
Lubricate cables					X
Replace cables	If stiffness continues after lubricating				
Check bilge pump operation	X	X	X		X
Check blower operation	X	X	X		X
Adjust and tighten throttle linkage					X
Inspect shaft packing			X		X
Check shaft alignment/ensure it is within .003					X
Check and tighten motor mounts					X
Tighten pylon and tower mounting bolts	X	X	X		X
Tighten all hardware and fasteners					X
Oil teak swim platform (as needed)					X
Change engine oil and filter (every 100 hrs. or annually)				X	X
Change fuel water separator (every 100 hrs. or annually)				X	X
Change transmission fluid (every 100 hrs. or annually)				X	X
Check engine oil	X				
Check transmission		X			
Check water pickups for debris or marine growth		X			
If equipped with a strainer, check and clean		X			
If operated in salt water, flush engine/cooling system and boat	X				

IF PROPELLER STRIKES AN OBJECT, INSPECT DRIVE TRAIN IMMEDIATELY!

I certify that the 400-Hour Service has been conducted and a copy will be sent to: **Tigé Boats, Inc.,
1801 Hwy. 36
Abilene, TX, 79602**

Place Stamp Here

Signature of Mechanic

Date

TROUBLESHOOTING AND SERVICE REQUIREMENTS

500-HOUR SERVICE REQUIREMENTS

Boat # _____

This service must be performed to keep warranty active. Please see your dealer.

Tigé Maintenance Schedule	DAILY	WEEKLY	REGULAR	ANNUAL	500 HRS.
Smell bilge area for fuel vapors	X	X	X		X
Check and tighten all steering system bolts and connections					X
Check rudder, tiller arm bolt and safety setscrew					X
Lubricate rudder stuffing box and steering support tube					X
Lubricate cables					X
Replace cables	If stiffness continues after lubricating				
Check bilge pump operation	X	X	X		X
Check blower operation	X	X	X		X
Adjust and tighten throttle linkage					X
Inspect shaft packing			X		X
Check shaft alignment/ensure it is within .003					X
Check and tighten motor mounts					X
Tighten pylon and tower mounting bolts	X	X	X		X
Tighten all hardware and fasteners					X
Oil teak swim platform (as needed)					X
Change engine oil and filter (every 100 hrs. or annually)				X	X
Change fuel water separator (every 100 hrs. or annually)				X	X
Change transmission fluid (every 100 hrs. or annually)				X	X
Check engine oil	X				
Check transmission		X			
Check water pickups for debris or marine growth		X			
If equipped with a strainer, check and clean		X			
If operated in salt water, flush engine/cooling system and boat		X			

IF PROPELLER STRIKES AN OBJECT, INSPECT DRIVE TRAIN IMMEDIATELY!

I certify that the 500-Hour Service has been conducted and a copy will be sent to: **Tigé Boats, Inc.,
1801 Hwy. 36
Abilene, TX, 79602**

Place Stamp Here

Signature of Mechanic

Date

ORIGINAL OWNER INFORMATION

Owner Name: _____

Address: _____

City: _____ State: _____ Zip: _____

E-Mail: _____

Boat Number _____ Date of Purchase: _____

Dealer: _____

SECOND OWNER INFORMATION

Owner Name: _____

Address: _____

City: _____ State: _____ Zip: _____

E-Mail: _____

Boat Number _____ Date of Purchase: _____

Dealer: _____

Ask about the transferable Tigé LifePlus Lifetime Replacement Warranty.



tigé 

1801 Hwy. 36 • Abilene, TX 79602 • 325.676.7777 • www.tige.com