



**OWNER'S MANUAL FOR
RUNABOUTS AND CUDDY
CABIN BOATS**

RINKER

Owner's Manual

Model/Number: _____ Design Category: A B C D
(circle one)

Hull Identification Number: _____

Date of Purchase: _____ Maximum Rated
Engine Power—
kilowatts (horsepower) _____

Dealer Name: _____

Address: _____ Unladen Weight—
kilograms (pounds) _____

_____ Maximum Load:

Phone Number: _____ Weight—kilograms (pounds) _____

Number of People _____

"This manual has been compiled to help you to operate your craft with safety and pleasure. It contains details of the craft, the equipment supplied or fitted, its systems and information on its operation and maintenance. Please read it carefully, and familiarize yourself with the craft before using it.

If this is your first craft, or you are changing to a type of craft you are not familiar with, for your own comforts and safety, please ensure that you obtain handling and operating experience before "assuming command" of the craft. Your dealer or national sailing federation or yacht club will be pleased to advise you of local sea schools, or competent instructors.

PLEASE KEEP THIS MANUAL IN A SECURE PLACE, AND HAND IT OVER TO THE NEW OWNER WHEN YOU SELL THE CRAFT."

For a complete list of standard and optional features and equipment, consult your local dealer. Due to a policy of continual product improvement, specifications are subject to change without notice. The weights and volumes shown are estimated and can vary from boat to boat because of equipment, etc. Rinker boats meet or exceed both NMMA and U.S. Coast Guard standards.

CERTIFICATION AND SPECIFICATION

All Rinker boats meet or exceed U.S. Coast Guard requirements.

The CE Mark means your Rinker boat meets or exceeds the European Directives for Recreational Vessels as published by the International Organization for Standardization (ISO).

All Rinker boats are National Marine Manufacturers Association (NMMA) certified. NMMA certified vessels are in compliance with applicable federal regulations.

Rinker boats are International Marine Certification Institute certified (IMCI) for the EU Directive for recreational craft.

International Marine Certificate Institute
Treves Centre
rue de Treves 45
1040 Brussels, Belgium
Tel. Int + (32) 2 236 7892
Rinker Certificates - RKR001 thru RKR013

National Marine Manufacturers Association
200 E. Randolph Dr.
Suite 5100
Chicago, Illinois U.S.A. 60601
Tel. (312) 946-6200

TABLE OF CONTENTS

INTRODUCTION	1
WELCOME ABOARD	1-1
YOUR OWNER'S MANUAL	1-1
CONSTRUCTION AND STANDARDS	1-2
TRAILERING	1-2
RESPONSIBILITIES	1-3
OWNER'S LOGS & RECORDS	1-4
WARRANTY	1-4
BOAT DATA RECORD	1-5
TRAVEL PLAN LOG	1-6
FUEL USAGE CHART	1-7
WARRANTY COPY	1-8

SAFETY	2
HAZARD COMMUNICATION STATEMENTS	2-1
RECOMMENDATIONS	2-1
CARBON MONOXIDE HAZARD	2-3
SAFETY EQUIPMENT	2-5
ILLEGAL TO DUMP	2-6
UNDERWAY	2-7
NAVIGATIONAL AIDS CHART	2-9
WATER SPORTS	2-11
SAFETY TIPS	2-11
WATER SKIING	2-11
ADDITIONAL EQUIPMENT	2-12
HAZARD COMMUNICATION LABELS	2-12

SYSTEMS & COMPONENTS	3
ELECTRICAL • 12 VOLT DC	3-1
DC SCHEMATIC WIRING DIAGRAM	3-2
FUEL SYSTEM	3-3
ENGINE EXHAUST SYSTEM	3-3
INSTRUMENTATION AND CONTROLS	3-3
COMPONENTS	3-5

GETTING UNDERWAY	4
TRAINING COURSES	4-1
TRANSPORTING	4-1
LAUNCHING	4-2
FUELING	4-2
LOADING PASSENGERS AND GEAR	4-3
STARTING THE ENGINE	4-4
LEAVING THE DOCK	4-5
STEERING	4-6
ACCELERATING	4-6
TRIMMING	4-7

GETTING UNDERWAY, CONT.	4
STOPPING	4-7
ANCHORING	4-8
DOCKING	4-8
MOORING	4-9
GOING ASHORE	4-9
ADDITIONAL UNDERWAY INFORMATION	4-9

MAINTENANCE & REPAIR	5
ENGINE	5-1
CHANGING OIL AND OIL FILTER	5-1
FUEL SYSTEM	5-3
COOLING SYSTEM	5-3
STERN DRIVE UNIT (I/O)	5-3
PROPELLER	5-4
POWER STEERING SYSTEM	5-4
BILGE	5-5

TROUBLESHOOTING	6
ENGINE	6-1
POOR PERFORMANCE	6-5
VIBRATION	6-5

INTERIOR & EXTERIOR CARE	7
FIBERGLASS AND GELCOAT	7-1
DECK HARDWARE AND FITTINGS	7-3
WINDSHIELD AND PORTALS	7-3
CARPET	7-4
SEAT COVERINGS AND VINYL	7-4
CANVAS (WEATHER COVERINGS)	7-4
CABIN CUSHIONS, SIDE CURTAINS AND FABRICS	7-5

WINTERIZING & STORAGE	8
DRY STORAGE PREPARATION	8-1
ENGINE	8-1
FUEL SYSTEM	8-2
BATTERY	8-2
RECOMMISSIONING	8-2

NAUTICAL GLOSSARY	9
--------------------------------	----------

WELCOME ABOARD

We at Rinker Boat Company welcome you to our boating family and wish you many happy hours on your Rinker boat in the months and years ahead. As the owner of a new Rinker Cuddy or Runabout Boat, you have every right to be proud of your boat's style, comfort, and performance.

The Rinker family began building boats in 1945. Because your Rinker boat is backed by more than 50 years' experience, you can be confident that your craft has been designed, built, and tested to give you the ultimate in boating pleasure. Our rigorous inspection and testing program is your assurance that your boat meets or exceeds U.S. Coast Guard and the National Marine Manufacturers Association (NMMA) safety and quality standards in effect at the time your boat was manufactured.

YOUR OWNER'S MANUAL

This manual contains valuable information about your boat's operation and maintenance, plus tips on boating safety and seamanship. Before you put your boat into the water, read this manual and the engine owner's manual. Then keep both manuals stowed aboard your boat for reference.

Your owner's manual packet contains this owner's manual and owner's manuals from the suppliers of some of the more complex components with which your boat may be equipped such as engine, electronics, and pumps. The manufacturers of these products maintain their own warranty and service facilities. It is imperative that you fill out each warranty card and mail it to the manufacturer to indicate that you are a registered owner of the product. Record all information regarding the products on the Boat Data Record form. A copy is at the end of this chapter. Keep the form in a safe place at home, not on board the boat.

Use this manual as a guide for operating and maintaining your boat. Read it to become familiar with your boat's systems and components. Although the information may be detailed in some cases and general in others, the intent is to provide the information you need to operate and maintain your boat properly and safely.

Following is a summary of the manual's contents:

Introduction

Included in the Introduction chapter of the manual are the welcome aboard message to our new Rinker boating family members; trailering information, construction and standards, dealer and consumer responsibilities, warranty, and logs and records.

Safety

The Safety chapter contains safety recommendations, safety information and practices, water sports safety, and safety equipment (on board and underway) which provide a reasonably safe operating environment. Additionally, specific safety warnings and comments are located throughout the owner's manual where appropriate.

Systems and Components

This chapter consists of detailed information about your boat's instruments and controls; its electrical, fuel, exhaust, and steering systems; and its components, such as bilge pump, bilge blower, navigation lights, and others.

Getting Underway

The intent of this chapter is to provide you with information about launching and loading your boat, getting underway, operation underway, and returning from your outing.

Preventive Maintenance & Repairs

The chapter contains recommendations for the inspection frequencies and adjustments needed to keep your boat in sound operating condition.

Troubleshooting

This chapter covers engine- and operation-related problems which the owner or operator can resolve.

Interior and Exterior Care

This chapter includes instructions for inspecting, cleaning, and maintaining your boat's interior and exterior.

Winterizing and Storage

In this chapter are information and procedures for winterizing your boat or storing it for extended periods of time.

Nautical Glossary

The Nautical Glossary defines terms associated with your boat and terms you may encounter during your boating experience.

CONSTRUCTION AND STANDARDS

All Rinker inboard/outboard powered boats meet or exceed U.S. Coast Guard and National Marine Manufacturers Association requirements for flotation. Under swamped conditions, a Rinker inboard boat (under 20 feet in length) will continue to have BASIC flotation. During swamped conditions, boats with upright/level flotation will remain upright and level in mild to moderate waters.

All Rinker inboard/outboard powered boats meet or exceed the following U.S. Coast Guard and NMMA requirements:

- Backfire flame arrestors
- Basic flotation (applies only to boats under 20 feet in length)
- Engine and fuel tank compartment ventilation
- Factory installed fuel systems
- Navigational lights
- Steering system

TRAILERING

Improper trailering is one of the major causes for damage to the hull. A correctly selected trailer provides you with proper support, safe and easy towing, and ease of unloading and loading in varying weather conditions.

The type and the size of the side supports, or pads, are very important. Side supports run lengthwise to the boat and parallel to the keel. Newer trailers feature self-adjusting side supports and an adjustable bow pad. Adjustable pads eliminate the task of manually adjusting side supports and keel rollers every time you load your boat. Your Rinker dealer can help you select the trailer that best fits your boat.

Inspect your trailer periodically to make sure the side supports are in good working condition. **Remember:** Any side support should be just tight enough to keep the boat from leaning side to side. Any unnecessary pressure will damage the hull.

The trailer for your new Rinker boat should be designed and built to carry the full weight of your boat, engine, and gear while providing support for the hull. Be sure not to overload your trailer by loading the boat with excess baggage, camping equipment, and the like. A certification label on your trailer frame must, by law, show the Gross Vehicle Weight Rating (GVWR). Be sure that the total weight of your boat, engine, fuel, gear and trailer does not exceed the GVWR. Ensure that your towing vehicle is equipped with a hitch capable of handling the GVWR.

The published weight is the dry weight of your boat. Dry weight does not include the weight of batteries, gasoline, gear and any optional items. The weight of these items must be added to the dry weight to determine the proper trailer GVWR needed.

Tongue weight is generally determined as a percentage of the total weight of the loaded trailer. Tongue weight should be not less than 5% and not more than 10% of the total weight. For example, if the weight of the loaded trailer is 2000 pounds, the weight on the tongue should be more than 100 pounds but less than 200 pounds. A weight distribut-

ing hitch transfers portions of tongue weight to a point between the front and rear wheels of the towing vehicle and to the trailer wheels.

▲WARNING

WARNING: Balancing the load on the trailer is extremely important. If weight at the tongue is excessive the towing vehicle will oversteer, a condition that will cause the front end of the vehicle to sway. Conversely, insufficient tongue weight will cause the trailer to fishtail. In both cases, the vehicle will be difficult to handle and at higher speeds the swaying or fishtailing can become uncontrollable.

State laws require that trailers above a specific Gross Vehicle Weight Rating (GVWR) have brakes. (Since state requirements may vary, check with your dealer for more information.) The brake system is usually completely self-contained on the trailer, and no hookup to the towing vehicle is required. The trailer is equipped with either drum or disc brakes. The brake works like the brake on a standard passenger vehicle, but the method of actuation does differ. Discuss any questions you may have with your Rinker dealer.

RESPONSIBILITIES

Your Rinker dealer is a trained professional with the necessary facilities and resources available to accommodate your boating needs. Discuss with your dealer any problems you cannot resolve.

Dealer

1. The dealer will discuss the terms of all warranties, and stress the importance of registering warranties with the appropriate manufacturers.
2. The dealer will provide instruction for obtaining warranty service.
3. The dealer will go over the pre-delivery service record with you, and then sign it to certify that all work has been done.

4. The dealer will provide you with thorough instruction in the operation of your boat and all of its systems and components.

Owner

You, the owner, have responsibilities also.

1. Schedule an appointment with your dealer to go over all warranties. Complete the Rinker Boat limited warranty registration card. The card is in an envelope inside the owner's manual packet. Keep a record of the hull number for future reference.
2. Inspect the boat at the time of delivery to ensure that all systems and components are operating properly.
3. Schedule an appointment with your dealer to go over the pre-delivery engine service record. Sign this record to indicate that it has been explained to you by your dealer.
4. Operate all equipment in accordance with the manufacturer's instructions. Read all manuals and instructions supplied with your boat.
5. Refer to your engine warranty for initial inspection and service requirements.
6. Perform or provide for the appropriate periodic maintenance outlined in the owner's manuals and service guides.
7. Schedule your boat's 20 hour check-up with your dealer.
8. As a boat owner/operator, it is your responsibility to learn your boat's dimensions, especially its draft and bridge clearance (on and off the trailer), to prevent accidents and damage.

IMPORTANT: Make sure your dealer checks the engine alignment during the 20 hour check-up and annually thereafter. The engine alignment check should be performed in accordance with the recommended procedures as stated by the engine manufacturer in the engine manual. Failure to do so could result in drive train damage not covered by the Rinker Boat Warranty.

OWNER'S LOGS & RECORDS

Three useful forms are at the end of this chapter.

The **Boat Data Record** is used to record all of your boat's important information as well as the major components installed on your boat. Once you have entered all the data, remove this form from your Owner's Manual and store it in a safe place. Do not keep this form aboard your boat.

The **Travel Plan Log** provides a record of your destination, departure and return times, boat description, passenger list, and other information about your boating trip. At the bottom of the form is an area for listing emergency telephone numbers in case you encounter trouble underway and have not returned by the time indicated on the log. There is also an entry area for the person filing this report to the proper authorities (in the event of an emergency) to list his or her name, location, and telephone number. You should make several copies of this form to use during each boating season. Leave the form ashore with a responsible person.

The **Fuel Usage Chart** is a handy way to record information covering engine hours, fuel consumption, miles traveled, as well as RPM, average MPH, and gallons per hour (GPH).

WARRANTY

You are entitled to all the benefits and services set forth in the warranties. If a problem arises with your Rinker boat as a result of workmanship or materials, contact your Rinker Boat dealer as soon as possible. Please have your hull identification number, and necessary model numbers on hand for the items that may need service or repair. Your hull identification number is located below the rub rail on the starboard rear corner of your boat.

Boat Data Record

Rinker Model Name _____	Hull Identification Number _____
Boats Name (if any) _____	State _____ Length _____ Beam _____
Servicing Dealership	Purchase Dealership
Name _____	Name: _____
Address _____	Address _____
Phone Number _____	Phone Number _____
Fax Number _____	Fax Number _____
Service Manager _____	Point of Contact _____
Hull Color(s) _____	Weight _____
Draft (drive down) _____ (drive up) _____	Freeboard (forward) _____ (aft) _____
Engine(s)	
Make _____ Model Name _____ HP _____ Model No. _____	
Oil SAE _____ Quarts/Engine(s) _____ Oil Filter Type _____	
Port Serial No. _____ Transom Plate Serial No. _____	
Starboard Serial No. _____ Transom Plate Serial No. _____	
Drive Unit(s) Gear Ratio _____	
Port Serial No. _____ Starboard Serial No. _____	
Fuel Tank Capacity _____ Number of Tanks _____ Fuel Filter Type _____	
Freshwater Tank Capacity _____ Number of Tanks _____	
Propeller(s) Manufacturer _____ Diameter _____ Pitch _____	
Generator	
Make _____ Model Name _____ Model No. _____	
Serial No. _____ Kilowatts _____	
Air Conditioner	
Make _____ Model Name _____ Model No. _____	
Serial No. _____ BTU _____	
Battery Make _____ Type _____	
Radio	
Make _____ Type _____ Model No. _____ Serial No. _____	
Key Numbers Cabin _____ Glove Box _____ Ignition(s) _____ / _____	
Additional Equipment _____	

Travel Plan Log

1. **Trip Expectations** Departure date/time _____ From _____
Destination _____ or _____
Expected return date/time _____ and in no event later than _____

2. **Boat Description** Boat name _____ Type _____
Color of: Hull _____ Deck _____ Cabin _____ Trim _____
Registration No. _____ Length _____ Make _____
Other physical characteristics _____

3. **Engine(s)** Type _____ HP _____ Fuel Type _____ Gallons _____

4. **Survival Equipment On board** (check all that apply) _____ Anchor _____ Cushions _____ Distress Light
_____ Flares _____ Flash Light _____ Food _____ Life Jackets _____ Mirror _____ Paddles
_____ Raft/Dingy _____ Smoke Signals _____ Water

5. **Radio On board** (____ yes ____ no) Frequencies _____

6. **Additional information** _____

7. **Passengers Aboard** Total number _____

Name _____ Age _____ Sex ____ Phone No. _____
Address _____

Name _____ Age _____ Sex ____ Phone No. _____
Address _____

Name _____ Age _____ Sex ____ Phone No. _____
Address _____

Name _____ Age _____ Sex ____ Phone No. _____
Address _____

Name _____ Age _____ Sex ____ Phone No. _____
Address _____

Note: Use additional sheet for more passengers. Additional sheet attached ____ yes ____ no.

If not returned by _____ call one or more of the following emergency telephone numbers:
Coast Guard _____ Local Authority _____ Rescue Center _____
Name of person filing report _____
Location and Telephone Number _____

Rinker Boat recommends filing a copy of this Travel Plan each time you depart in your boat. Leave the form with a responsible person ashore. A relative, friend, marina manager, or dockmaster.

LIMITED WARRANTY

Coverage Under This Limited Warranty

Rinker Boat Company, Inc. ("Rinker") warrants to the original consumer purchaser that each new Rinker boat will be free from substantial defects in materials and workmanship for a period of one (1) year from the date of purchase under normal conditions and recommended use, subject to the exclusions listed below. In addition, Rinker warrants that the boat hull will be free of structural defects in material and workmanship for a period of five (5) years from date of purchase, subject also to the exclusions listed below.

THIS WARRANTY DOES NOT APPLY TO: (1) equipment or accessories not manufactured by Rinker, whether or not separately warranted, including but not limited to engines, batteries, steering assembly, outdrives, propellers, and controls; (2) any boat which has been repaired or altered in any way so as to affect its use or operation; (3) Gel-Coat cracking or crazing, blistering, or discoloring; (4) windshield breakage; (5) any upholstery damage, including but not limited to tears, punctures, fading or soiling; (6) any boat which was overpowered according to the U.S. Coast Guard recommended engine horsepower on capacity plate; (7) damage caused to fly wheels, ring gears, starters, oil pans, electrical components, and the basic engine by water in the bilge, whether it be fresh or salt; (8) any boat used for racing, commercial, or rental purposes or any boat subject to misuse, negligence, accident or used in any unauthorized manner; (9) accessories, components, machinery or equipment that is not installed by Rinker at its factory; (10) routine maintenance or any condition resulting from failure to perform routine maintenance as required; (11) scratches, dents or other surface blemishes; (12) damage caused by continued use of the boat after a defect is or should have been discovered; (13) water damage of any nature or dry rot to interior surfaces, wood structures, upholstery or polyurethane frame; and (14) any published or announced performance characteristics including, but not limited to, speed, or fuel and oil consumption.

Registration Required For Limited Warranty Coverage

IN ORDER FOR YOU TO BE ELIGIBLE FOR COVERAGE UNDER THIS LIMITED WARRANTY, THE WARRANTY REGISTRATION CARD MUST BE COMPLETED AND SIGNED BY YOU AND RETURNED TO RINKER WITHIN FIFTEEN (15) DAYS AFTER THE DATE OF PURCHASE.

In addition to validating your warranty coverage, returning the registration card will allow Rinker to provide you with notice of any condition Rinker may need to supply after you have purchased the boat.

Your Obligations in the Event of a Defect

IF YOU BELIEVE YOU HAVE A CLAIM UNDER THIS LIMITED WARRANTY, YOU MUST GIVE WRITTEN NOTICE OF YOUR CLAIM TO RINKER AT 300 W. CHICAGO STREET, SYRACUSE, INDIANA 46567, AND/OR THE DEALER WITHIN THE APPLICABLE WARRANTY PERIOD AND WITHIN A REASONABLE PERIOD OF TIME (NOT TO EXCEED THIRTY (30) DAYS) AFTER THE DEFECT IS OR SHOULD HAVE BEEN DISCOVERED. Your notice must describe the defect, provide your name and address, the name and address of the dealer from whom you purchased the boat, and the date of purchase. You must pay all incidental expenses incurred in obtaining warranty service, including, without limitation, transportation of the boat and postage or delivery charges to and from the dealership or Rinker's factory.

Remedies Under This Limited Warranty

Rinker will reply to you within a reasonable period of time after it receives your claim and it reserves the right to require you to furnish additional information or evidence at your expense. Further, Rinker reserves the right to inspect the boat within a reasonable period of time after it receives your claim.

All warranty work is to be performed at a Rinker authorized dealer or service center, or at Rinker's factory, after it is established to Rinker's satisfaction that there is a substantial defect in materials and workmanship covered by this Limited Warranty. Rinker will designate the location where the warranty work will be performed. The defective parts or the entire boat must be delivered, at Rinker's option, to an authorized dealer or service center, or to Rinker's factory, at your expense. **REPAIR OR REPLACEMENT, AT RINKER'S ELECTION, IS THE SOLE AND EXCLUSIVE REMEDY AND NO OTHER LEGAL OR EQUITABLE REMEDIES SHALL BE AVAILABLE TO THE ORIGINAL CONSUMER PURCHASER.**

Warranty performance will commence within a reasonable time after Rinker's receipt of the required notice and confirmation that the defect is covered under this Limited Warranty, and will be completed within a reasonable time, subject to the availability of parts and scheduling. Rinker cannot guarantee any specific completion date due to the different nature of claims that may be made and the services that may be required.

The term of the Limited Warranty for any repaired or replaced defective parts will be the remaining unexpired portion of the original warranty period for the original part.

Disclaimer of Incidental and Consequential Damages

THE ORIGINAL CONSUMER PURCHASER OF THE NEW RINKER BOAT COVERED UNDER THIS LIMITED WARRANTY SHALL NOT BE ENTITLED TO RECOVER FROM RINKER ANY SPECIAL, INDIRECT, INCIDENTAL OR CONSEQUENTIAL DAMAGES RESULTING FROM ANY DAMAGE OR DEFECTS. RINKER WILL NOT BE LIABLE TO THE ORIGINAL CONSUMER PURCHASER FOR HAUL-OUT, LAUNCH, TOWING OR STORAGE CHARGES, INCONVENIENCE, LOSS OF TIME, LOSS OF INCOME, SHIPPING OR DELIVERY CHARGES, OR ANY OTHER INCIDENTAL OR CONSEQUENTIAL DAMAGES OF ANY NATURE OR KIND.

Some states do not allow the exclusion or limitation of incidental or consequential damages, so the above exclusion or limitation may not apply to you.

Limitation and Disclaimer of all Implied Warranties

RINKER EXPRESSLY LIMITS THE DURATION OF ANY IMPLIED WARRANTIES OF MERCHANTABILITY AND ALL IMPLIED WARRANTIES OF FITNESS FOR A PARTICULAR PURPOSE TO THE TERM OF THIS LIMITED WARRANTY. RINKER EXPRESSLY DISCLAIMS ANY IMPLIED WARRANTIES OF MERCHANTABILITY AND IMPLIED WARRANTIES OF FITNESS FOR A PARTICULAR PURPOSE AFTER EXPIRATION OF THIS LIMITED WARRANTY. THERE IS NO WARRANTY OF ANY NATURE, EXPRESS OR OTHERWISE, MADE BY RINKER BEYOND THAT CONTAINED IN THIS LIMITED WARRANTY. NO PERSON HAS AUTHORITY TO ENLARGE, AMEND, OR MODIFY THIS LIMITED WARRANTY.

Some states do not allow limitations on how long an implied warranty lasts, so the above limitation may not apply to you.

General Provisions

This Limited Warranty gives you specific legal rights and you may also have other rights which vary from state to state. No action to enforce this Limited Warranty shall be commenced later than six (6) months after expiration of this Limited Warranty.

Due to continuing improvements and changes in product features and options, Rinker reserves the right to make changes at any time, without notice, in specifications, equipment, materials, pricing, and to discontinue models, without any obligations to maintain spare parts or to make corresponding changes in products previously manufactured.

This Limited Warranty is not transferable by the Original Consumer Purchaser.
RINKER BOAT COMPANY, INC.
300 West Chicago Street
Syracuse, IN 46567

Effective 12-01-95

HAZARD COMMUNICATION STATEMENTS

Five levels of advisory and cautionary statements are used throughout this manual to call attention to special information, operating procedures and safety precautions. Statements, set off with a signal word, identify the level of significance that it conveys.

Advisory Statements

Advisory statements consist of two levels: **NOTE** and **IMPORTANT**. Advisory statements alert you to conditions that affect equipment operation, maintenance and servicing practices.

A **NOTE** statement is a general advisory statement relating to equipment operation and maintenance procedures. A **NOTE** statement draws attention to information that is of more importance than normal text.

An **IMPORTANT** statement is an advisory statement or procedure intended to prevent damage to the equipment or associated components. Not adhering to the instructions in an **IMPORTANT** statement could result in damage to the equipment.

Hazard Seriousness Level

The signal words **DANGER**, **WARNING** and **CAUTION** identify hazards and the levels of hazard seriousness. Their selection is based on how a hazard can affect a person:

1. The degree of severity.
(Minor injury, severe injury, death)
2. The probability of severity.
(WILL result in, COULD result in)

Definitions for identifying hazard levels with their respective signal words are as follows:

▲ DANGER

DANGER Immediate hazards that **WILL** result in severe personal injury or death.

▲ WARNING

WARNING Hazards or unsafe practices that **COULD** result in severe personal injury or death.

▲ CAUTION

CAUTION Hazards or unsafe practices that **COULD** result in minor personal injury or product or property damage.

RECOMMENDATIONS

Your safety and the safety of your passengers are your responsibility. You should fully understand and become familiar with the following safety precautions before launching your Rinker boat:

- Always operate your boat with care, courtesy and common sense. Understand and obey the Rules of the Road.
- Keep your boat and equipment in safe operating condition. Make a practice of inspecting the hull, engine, and all boating gear.
- Be sure that regulation lifesaving and fire extinguishing equipment is on board. Periodically inspect all safety equipment to be sure it is in proper operating condition. Make sure all passengers know what safety equipment is on board, where it is, and how to use it.

- Do not allow passengers to ride on parts of your boat other than designated seating areas. Make sure passengers remain seated while underway. Passengers seated in the bow area should not obstruct driver's vision.
- If your boat has a walk-through windshield, secure it in the closed position before accelerating faster than idle speed.
- Keep an eye on the weather. Be aware of possible changing conditions by checking local weather reports prior to departure. Monitor strong winds and electrical storms closely.
- Be **very careful** when fueling your boat. Be aware of the boat's fuel tank capacity and fuel consumption for frequently used engine speeds.
- Make sure you have enough fuel for your boating excursion. Keep an adequate reserve of fuel in case your plans change due to weather or other circumstances. The most common practice for good fuel management is the **one-third rule**. Use one-third of your fuel supply to travel to your destination and one-third to return. Keep the remaining one-third in reserve for emergencies.
- Always keep accurate updated charts of your boating area on board.
- Before departure, file a travel plan with a responsible person ashore.
- Make sure at least one other passenger knows the basic operating procedures for handling your boat in case you unexpectedly become unable to do so.
- Do not use the swim platform or boarding ladder while the engine is running.
- Do not overload or improperly load your boat. You are responsible for using common sense and sound judgment. Turbulent water and unfavorable weather reduce the capacity of your boat. You should be aware of weather reports and water conditions before getting underway.

Safe Boating Courses

Your local U.S. Coast Guard Auxiliary and the U.S. Power Squadrons offer comprehensive safe boating classes several times a year. You may contact the Boat/U.S. Foundation at 1-800-336-BOAT (2628), or in Virginia 1-800-245-BOAT (2628). For a course schedule in your area you may also contact your local U.S. Coast Guard Auxiliary or Power Squadron Flotilla for the time and place of their next scheduled class.

Rules of the Road

Your Rinker boat is subject to U.S. Coast Guard-enforced marine traffic laws known as "**Rules of the Road.**" There are two sets of rules — the United States Inland Navigational Rules and the International Rules. The United States Inland Rules are applicable to all vessels inside the demarcation lines separating inland and international waters. You can get a copy of the "**Rules of the Road**" from your local U.S. Coast Guard Unit or the United States Coast Guard Headquarters (1300 E. Street NW, Washington, D.C. 20226) in the publication titled, "**Navigational Rules, International -Inland.**"

"**Aids to Navigation**" (U.S. Coast Guard pamphlet #123) explains the significance of various lights and buoys. This and other pamphlets, including the "**Boating Safety Training Manual**" and "**Federal Requirements For Recreational Boats,**" are also available from the U.S. Coast Guard Headquarters.

Because of proposed alterations for buoys and markers, contact the U.S. Coast Guard to stay informed of impending changes.

If you have a ship-to-shore radio telephone on board, heed storm warnings and answer any distress calls. The spoken word "**MAYDAY**" is the international signal of distress. "**MAYDAY**" should **NEVER be used unless there is present danger — an emergency — and you are in need of immediate assistance.**

Drugs and Alcohol

▲ WARNING

WARNING: Operating a boat while intoxicated or under the influence of drugs is dangerous and illegal. Impaired vision or judgment on the water can quickly lead to disaster. Driving any boat, requires sober, attentive care.

In the interest of safety, you must refrain from the use of drugs or alcohol while operating your boat. Federal law prohibits operating a boat under the influence of drugs or alcohol. These laws, which carry a significant penalty, are vigorously enforced. The use of drugs and/or alcohol will decrease reaction time, impair your judgment and inhibit your ability to operate your boat safely.

CARBON MONOXIDE HAZARD

Carbon monoxide poisoning can be a hazard whether your boat is moored or underway. You must be aware of your surroundings and how they may affect your safety and that of your passengers. Make sure of proper ventilation at all times.

IMPORTANT: Rinker Boat recommends that you have a CO monitor installed. The monitor must be professionally installed and calibrated.

▲ DANGER

DANGER: Carbon monoxide can be harmful or fatal if inhaled. Carbon monoxide in high concentrations can be fatal in minutes. To prevent exposure and reduce the possibility of carbon monoxide accumulation in the cabin, ensure adequate ventilation by opening cabin hatches, doors, windows, and side windshield vents to increase air movement.

Carbon monoxide (CO) is an odorless and colorless poisonous gas. Burning gasoline or any other fuel containing carbon produces carbon monoxide. Common sources of carbon monoxide include the exhaust from internal combustion engines and open flame devices such as cooking ranges and charcoal grills. Because its weight is about the same as that of air, it can quickly spread throughout a confined space such as a boat's cabin without the occupants being aware of its presence. It does not rise or fall as do some other gases.

When inhaled, carbon monoxide in the lungs combines with the blood to reduce the ability of the blood to carry oxygen. Reducing the oxygen supply to body tissues results in death of the tissue. Carbon monoxide in high concentrations can be fatal in minutes; however, the effects of exposure to lower concentrations are cumulative, and lower concentrations can be as lethal as high concentrations.

The symptoms of excessive exposure to carbon monoxide concentrations may include watering and itchy eyes, throbbing temples, ringing in the ears, inattentiveness, headache, nausea, dizziness and drowsiness. Certain health problems (for example, lung disorders or heart problems) and age will increase the effects of carbon monoxide as does consuming alcohol or inhaling high concentrations of cigarette smoke.

Many variables can affect carbon monoxide accumulation. Among these are the following:

- Boat layout and configuration
- Location of hatch, window, door and ventilation openings
- Location of structures and other boats
- Wind direction
- Vessel speed

Because this manual cannot identify or describe every possible variable or combination of variables, boat operators must remain aware of the possibility of carbon monoxide accumulation.

The following illustrations show how carbon monoxide can accumulate while at the dock or while underway. Become familiar with these examples and their precautions to prevent dangerous accidents.

⚠ DANGER

DANGER: Hull exhaust outlets blocked by a nearby pier, dock, seawall bulkhead, or any other means can cause excessive accumulation of poisonous carbon monoxide gas within the cabin areas. Make sure hull exhaust outlets are clear and open.

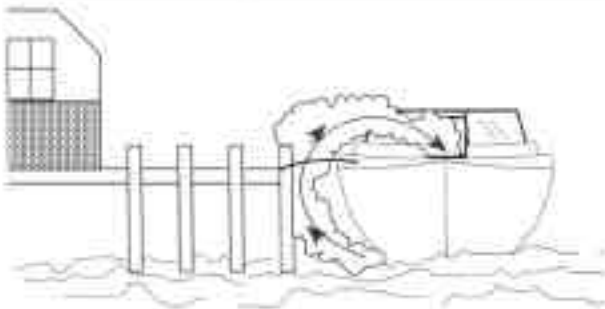

FIGURE 2.1 BLOCKED HULL EXHAUST OUTLETS

⚠ DANGER

DANGER: Engine and generator exhaust from other vessels alongside, while docked or anchored, can emit carbon monoxide and cause excessive accumulation in the cabin and cockpit areas. Be alert for exhaust from other vessels alongside.



FIGURE 2.2 EXHAUST FROM OTHER VESSELS

⚠ DANGER

DANGER: When protective weather coverings are in place, hull exhaust from your boat while underway can cause excessive accumulation of carbon monoxide within the cabin and cockpit areas. Provide adequate ventilation when the canvas top, side curtains, or aft curtains are in place.



FIGURE 2.3 CO ACCUMULATION WITH PROTECTIVE COVERINGS

⚠ DANGER

DANGER: While underway, engine exhaust from your boat can cause excessive accumulation of carbon monoxide within cabin and cockpit areas when operating boat with a high bow angle. Provide adequate ventilation, redistribute the load, or operate at lower bow angle.



FIGURE 2.4 HIGH BOW ANGLE

⚠ DANGER

DANGER: Engine exhaust from your boat, when operating at slow speed or stopped, can cause excessive accumulation of carbon monoxide within the cabin and cockpit areas. Force of tail wind can increase accumulation. Provide adequate ventilation or slightly increase speed if possible.



(Operation at slow speed)



FIGURE 2.5 OPERATION AT SLOW SPEED AND PROPER VENTILATION

SAFETY EQUIPMENT

Federal law requires you to provide and maintain safety equipment on board your boat. Check U.S. Coast Guard, state, and local regulations to ensure your boat has all required safety equipment on board. Additional equipment may be recommended. For your own safety and that of your passengers, make yourself aware of its availability and use.

Personal Flotation Devices (PFDs)

There must be one United States Coast Guard approved wearable personal flotation device of Type I, II, or III for each person on board or being towed on water skis, water sports tubes, kneeboards, etc. The PFDs must be of a suitable size for each person, and they must be in serviceable condition and readily accessible.

- **PFD Type I, Wearable** This PFD has the greatest required buoyancy. Its design allows for turning most unconscious persons in the water from face down position to a vertical or slightly backward position. Type I is most effective for all waters, especially offshore when rescue may be delayed.
- **PFD Type II, Wearable** Type II turns its wearer the same as Type I, but the turning action is not as pronounced as the Type I. The Type II will not turn as many persons under the same conditions as a Type I.
- **PFD Type III, Wearable** Type III allows the wearers to place themselves in a vertical or slightly backward position. Type III has the same buoyancy as a Type II PFD. It has little or no turning ability.
- **PFD Type V, Wearable**, must be worn to be effective. When inflated, it provides buoyancy equivalent to Type I, II or III PFDs. When it is deflated, however, it may not support some people.

Your Rinker boat also must have one throwable **PFD Type IV** device on board. The Type IV device can be thrown to a person in the water and grasped and held by the person until rescued. The design does not allow for it to be worn. The most common Type IV PFDs are buoyant cushions and ring buoys. The throwable Type IV PFD shall be immediately available for use, and in serviceable condition.

Fire Extinguishers

As the owner of a Rinker boat, it is your responsibility to comply with U.S. Coast Guard regulations regarding fire extinguishers. You must have at least one portable fire extinguisher (Type B-I, U.S. Coast Guard approved) on board the boat. This requirement applies to all Class 1 boats, 16 feet to less than 26 feet (4.9-7.9 m).

All fire extinguishers should be mounted in a readily accessible location away from the engine compartment. All persons on board should know where the fire extinguishers are and how to use them.

If a fire extinguisher has a charge indicator gauge, cold or hot weather may affect the gauge reading. Consult the instruction manual supplied with the fire extinguisher to determine the accuracy of the gauge.

Visual Distress Signals

U.S. Coast Guard regulations require all recreational boats be equipped with visual distress signal equipment. The regulations apply to boats used on coastal waters, which includes the Great Lakes, territorial seas and those waters directly connected to the Great Lakes and the territorial seas, up to a point where the waters are less than two miles wide, and to boats owned in the United States when operating on the high seas.

Visual distress signal equipment may be of the pyrotechnic or non-pyrotechnic type. The equipment must be approved by the U.S. Coast Guard, be in serviceable condition, and be stowed in a readily accessible location. Equipment having a date for serviceable life must be within the specified usage date shown.

Approved pyrotechnic visual distress signals and associated equipment include:

- Red flares, hand held or aerial
- Orange smoke, hand held or floating
- Launchers for aerial red meteors or parachute flares

Approved non-pyrotechnic equipment includes orange distress flags and electric distress lights.

No one signaling device is ideal under all conditions or for all purposes. Consider carrying various types of equipment on board. ***Careful selection and proper stowage of visual distress equipment is very important if young children are frequently aboard.***

Whistle

Your boat must be equipped with a device that can produce a blast of two-second duration and audible at a distance of at least one-half mile. The device can be mouth-, hand-, or power-operated.

Boat Registration

Federal and state laws require that every boat equipped with propulsion machinery of any type must be registered in the main state where it is used. Registration numbers and validation stickers must be displayed on the boat as stated in the regulations. The registration certificate must be carried on board when your boat is being used.

Discharge of Oil

The Federal Water Pollution Control Act prohibits the discharge of oil or oily waste into or upon the navigable waters of the United States or the waters of the contiguous zone if such discharge causes a film or sheen upon or a discoloration of the surface of the water or causes a sludge or emulsion beneath the surface of the water. Violators are subject to a penalty of \$5,000.

Disposal of Plastics and Other Garbage

U.S. Coast Guard regulations absolutely prohibit the dumping of plastic refuse or other garbage mixed with plastic into the water anywhere. They restrict the dumping of other forms of garbage within specified distances from shore. Plastic refuse in the water can kill fish and marine wildlife. It can also foul vessel propellers and cooling water intakes. Other forms of waterborne garbage can litter our beaches and make people sick.

ILLEGAL TO DUMP

INSIDE 3 MILES (and in U.S. Lakes, Rivers, Bays and Sounds)

- Plastic
- Dunnage, lining and packing materials that float
- Any garbage except dishwater, gray water, fresh fish parts

3 TO 12 MILES

- Plastic
- Dunnage, lining and packing materials that float
- Any garbage not ground to less than one square inch

12 TO 25 MILES

- Plastic
- Dunnage, lining and packing materials that float

OUTSIDE 25 MILES

- Plastic

The U.S. Coast Guard has issued these regulations to implement Annex V of the International Convention for the Prevention of Pollution from Ships, 1973, commonly known as Annex V of the MARPOL (Marine Pollution) Treaty 73/78. They apply to all U.S. vessels wherever they operate (except waters under the exclusive jurisdiction of a state), and foreign vessels operating in U.S. waters out to and including the Exclusive Economic Zone (200 miles).

UNDERWAY

Fog

Fog is a result of either warm-surface or cold-surface conditions. You can judge whether fog is likely to form by periodically measuring the air temperature and dew point temperature. If the difference between these two temperatures is small, you are likely to run into fog.

Remember the following guidelines:

- As fog sets in take bearings, mark your position on the chart while continuing to log your course and speed.
- Ensure all persons on board have put on their personal flotation devices.
- If equipped with sounding equipment, take soundings regularly and match them with soundings on your charts.
- Station a person forward in the boat as a lookout.
- Reduce your speed. From time to time stop engine and listen for other fog signals.
- Sound the horn or fog bell intermittently to warn others.

- If there is any doubt about continuing your boat's movement, anchor.

Weather and Storms

Current and forecasted weather conditions are a primary consideration when planning a cruise. You should listen to local weather forecasts before leaving port. You should also learn to recognize the weather signals flown by many cruiser clubs.

Storms can nevertheless come up without much advance notice. Although accurate weather information is available from meteorological observation and reporting stations, predictions are sometimes incorrect or data gathering equipment may fail. A good skipper will watch the horizon for an approaching storm.

There is no substitute for a keen observation of weather conditions and a good knowledge of what action to take when the weather takes a turn for the worse. If a storm does come up, do the following:

- Keep a watch on the horizon for approaching storms.
- Turn radio on. Dial in a local weather reporting station and monitor forecast.
- Return to a safe port if time allows (the best possible alternative).
- Close portals and hatches and secure them. Stow all loose gear below deck and tie down any gear on deck.
- Reduce speed as the seas build. Make sure all persons on board have put on their personal flotation devices.
- Place a sea anchor out over the bow to maintain bow into seas. If no sea anchor is aboard, use a canvas bucket or any object that will offer resistance.

Fire

A fire aboard your boat is a serious emergency! You must work quickly to implement safety procedures.

IMPORTANT: Everyone on board should know where the fire extinguishers are and how to use it.

If a fire occurs:

- Stop the engine immediately.
- Have everyone on board put on a PFD (personal flotation device).
- If the fire is small, attempt to put it out with your fire extinguisher.
- If the fire is on the engine compartment, turn off the bilge blower. Do not open the engine compartment. Feeding more oxygen to the fire may cause it to flare up.
- If the fire gets out of control, send up a distress signal. Call for help if your boat has a ship-to-shore radio.

If the fire cannot be controlled and help is not available, everyone on board should jump overboard and swim a safe distance away from the flames. Stay together in a group. Swim to shore only if it is a **short** distance. Be aware that the distance to shore is often much farther than it appears to be. Looking for a person attempting to swim to shore makes rescue efforts more difficult.

Swamped or Capsized Boat

If your boat becomes swamped or capsizes, put on a PFD immediately and set off a distress signal. Chances are good that a capsized boat will stay afloat. For this reason, stay with the boat. Do not leave the boat or try to swim to shore except under extreme conditions. A capsized boat is easier to see than a swimmer, and the shore may be further away than it appears.

More often than not, boats sink while docked. Any number of factors may contribute to these sinkings. There may have been a mechanical failure such as a failed bilge pump or an electrical problem such as a dead battery or tripped circuit breaker. Check your boat regularly if it is docked for an extended period of time, to make sure everything is in order.

Hypothermia

If a person falls overboard, hypothermia may be an immediate concern. Hypothermia means a person's body loses heat to the water faster than the body can replace it. If not rescued, the person will become exhausted or likely drown. In general, the colder the water, the shorter the time for survival. PFDs will increase survival time because they provide insulation.

Hypothermia Chart

Water Temperature (F)	Exhaustion Unconsciousness	Expected Time of Survival
32.5	Under 15 min.	Under 15-45 min.
32.5-40	15-30 min.	30-90 min.
40-50	30-60 min.	1-3 hr.
50-60	1-2 hr.	1-6 hr.
60-70	2-7 hr.	2-40 hr.
70-80	3-12 hr.	3 hr-Indefinite
Over 80	Indefinite	Indefinite

Collision

In case of a serious collision, first check the condition of persons aboard. Then inspect the boat to determine the extent of damage.

- Have all persons on board put on their personal flotation devices.
- If your boat has a VHF radio, contact the U.S. Coast Guard or other rescue authorities immediately (VHF channel 16).
- Prepare to help the other craft unless your passengers or boat are in danger.
- If the bow of the other boat penetrated your boat's hull, prepare to plug the fracture once the boats are separated.
- Shore up the hole with a spare life jacket or bunk cushion inside your boat.
- While plugging the hole, trim weight to get the hole above the waterline.

Running Aground

If your boat runs aground, check persons on board for injury and inspect the boat and propeller for damage. If possible, shift weight of passengers or gear to heel boat while reversing engine.

WARNING

WARNING: Do not use deck hardware for grounding or towing. Rinker Boat recommends that you use a commercial towing service if your boat becomes grounded.

If you ground your boat on a sand bar, shut down the engine and seek help from another boater or radio for help. See your dealer as soon as possible, as sand sucked into the engine cooling system can cause major engine damage.

NAVIGATIONAL AIDS CHART

The following Navigational Aids Chart contains information concerning:

- Whistle Signals
- Storm Warnings
- Bridge Signals
- Buoy description and information

Navigational Aids Chart

REMEMBER THESE RULES

1. OVERTAKING - PASSING: Boat being passed has the right-of-way. KEEP CLEAR.
2. MEETING HEAD ON: Keep to the right.
3. CROSSING: Boat on right has the right-of-way. Slow down and permit boat to pass.

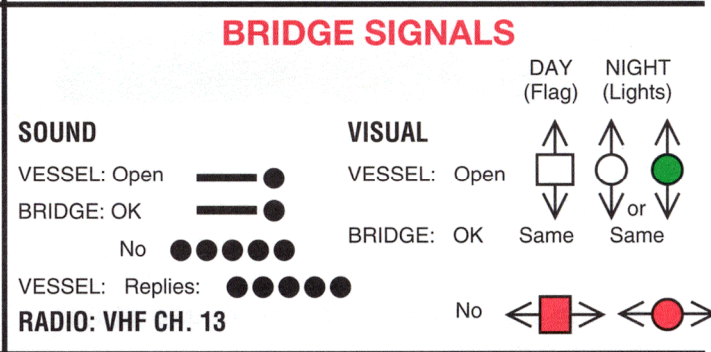
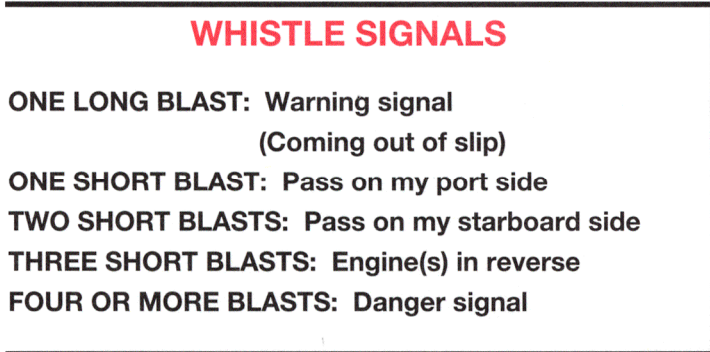
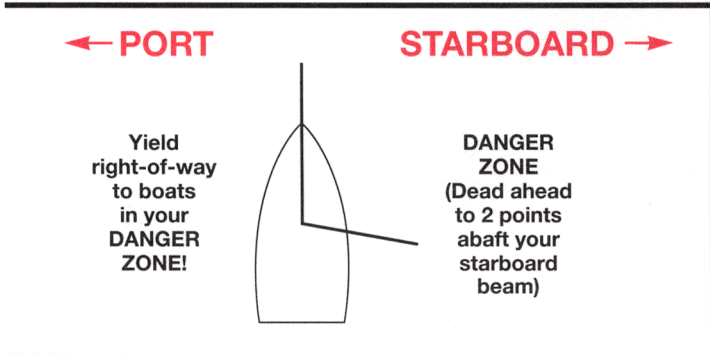

LATERAL AIDS AS SEEN ENTERING FROM SEAWARD

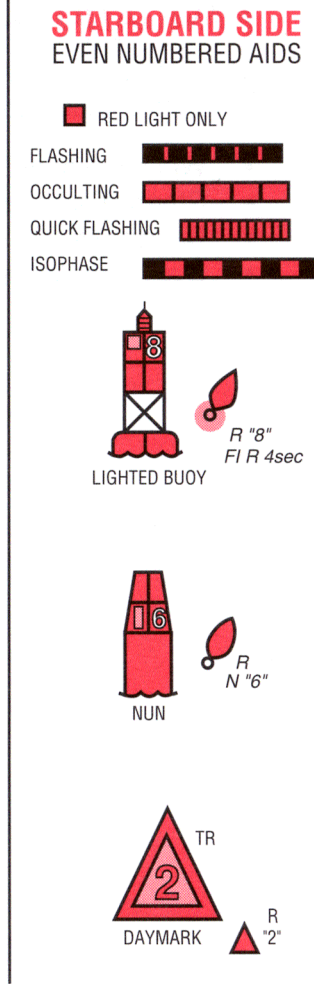
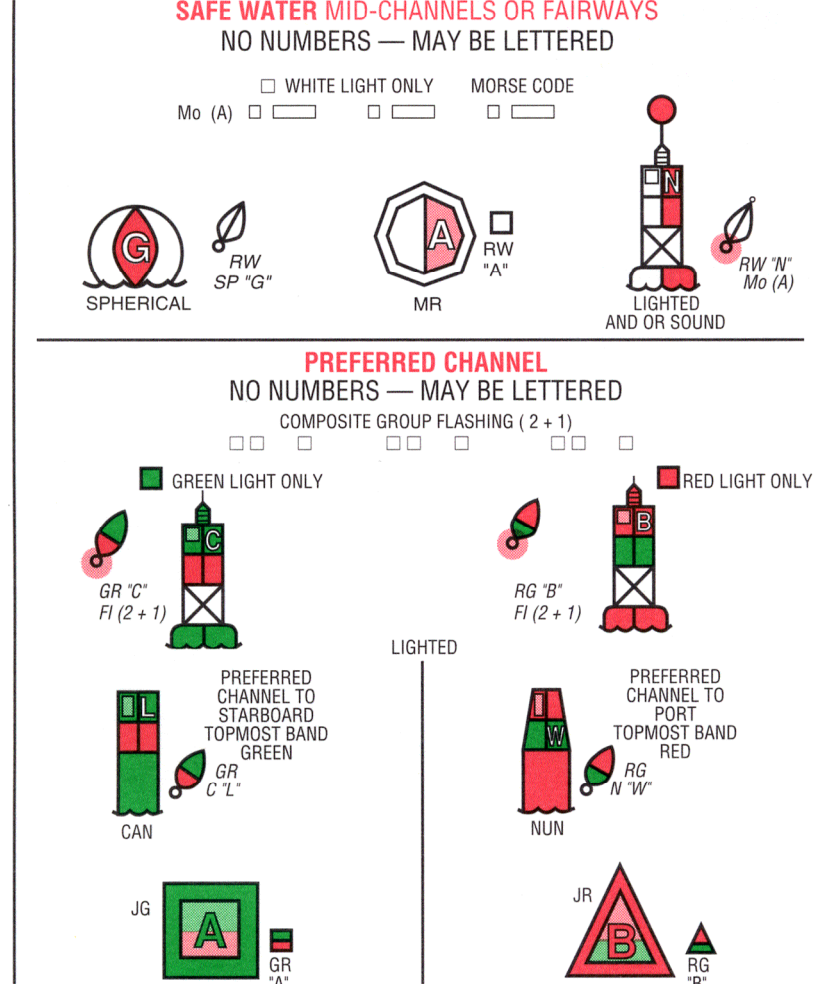
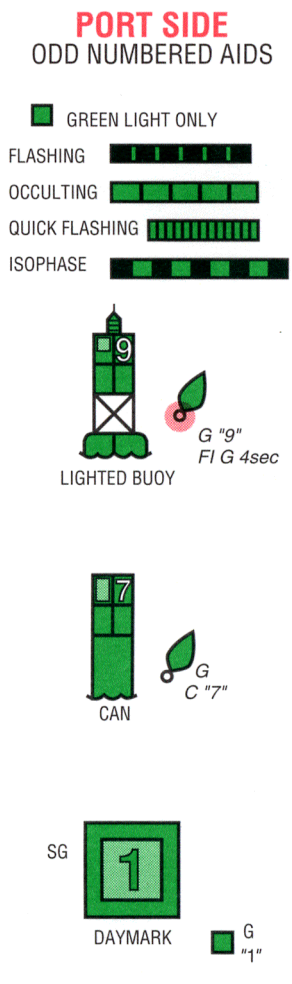

WATER SPORTS

The advancement of technology has created new and improved products for recreation on the water. Water skiing, kneeboarding and riding on inflatable towable devices require an increased safety awareness.

WARNING

WARNING: Rinker boats are not designed for and should not be used for towing of para-sails, kites, or any other device that is designed to become airborne when towed behind a boat.

SAFETY TIPS

1. Always wear a personal flotation device approved by the U.S. Coast Guard.
2. Have an observer aboard facing the rear to inform helmsman of what is taking place behind the boat.
3. Never participate in towed water sports near beaches or in restricted areas.
4. Stay out of channels and other heavily traveled waterways.

WATER SKIING

This popular sport has its own special precautions. The following guides will do much to reduce the hazards while water skiing.

1. Water ski only in safe areas, away from other boats and swimmers, out of channels and in water free of underwater obstructions.
2. Allow no one who cannot swim to water ski.
3. Be sure that the skier is wearing a proper personal flotation device. A properly designed ski vest is intended to keep a stunned or unconscious person afloat.
4. Always carry a second person on board to observe the skier so the driver can give full attention to the operation of the boat and the waters ahead.
5. Approach a skier in the water from the lee side, and be certain to stop your motor before coming in close proximity to the skier.
6. Give immediate attention to a fallen skier. He or she is vulnerable in the water alone and is difficult to see by other boaters.

The following illustration (Figure 2.6) identifies a set of hand signals recommended by the American Water Ski Association (AWSA).

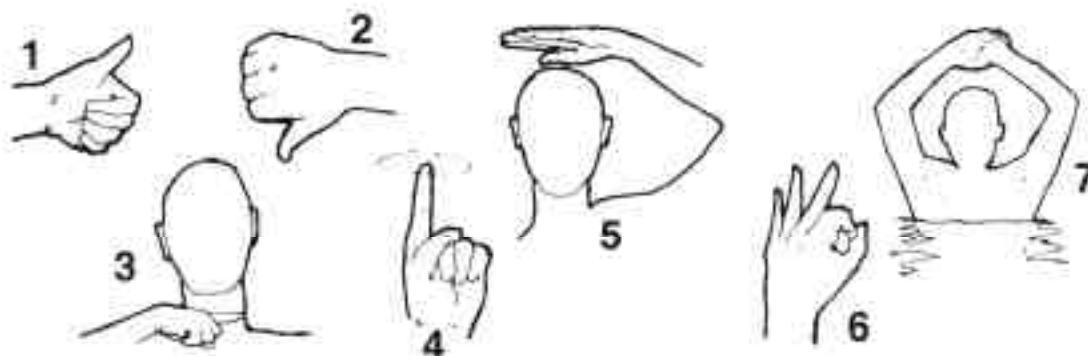

1. **Thumb Up:** Speed up the boat.
2. **Thumb Down:** Slow down the boat.
3. **Cut Motor/Stop:** Immediately stop boat. Slashing motion over neck (also used by driver or observer).
4. **Turn:** Turn the boat (also used by driver). Circle motion—arms over head. Then point in desired direction.
5. **Return to Dock:** Pat on the head.
6. **OK:** Speed and boat path OK, or signals understood.
7. **I'm OK:** Skier OK after falling.

FIGURE 2.6 WATER SKIING HAND SIGNALS

Skier, observer and boat operator should all know and understand these seven simple signals from the skier.

For more information about water skiing, Please contact the American Water Ski Association, 799 Overlook Drive, Winter Haven, Florida 33884 (1-800-533-2972).

ADDITIONAL EQUIPMENT

Rinker Boat recommends keeping additional safety equipment on board to help make your boating experience safer and more enjoyable. Examples of such equipment include the following:

- Anchor and line
- Boat hook
- Bucket and sponge
- Commonly used spare parts
- Compass, navigational charts
- Docking and towing lines
- Engine lubricating oil
- Extra keys
- Extra V-belts
- Fenders

- First-aid kit
- Flashlight and extra batteries
- Manually operated bilge pump
- Paddle
- Portable plastic fuel can (less than 7 gallon capacity)
- Replacement light bulbs
- Ship-to-shore radio
- Spare fuel and oil filters
- Spare propeller with fastening hardware
- Spare set of spark plugs and ignition parts
- Tool kit

HAZARD COMMUNICATION LABELS

Some or all of the hazard communication labels shown below can be found in various locations on board your Rinker boat. If any label is missing, notify your Rinker dealer for a replacement.

NOTE: Respective labels are determined by the standard and optional equipment actually installed on board your boat upon delivery.

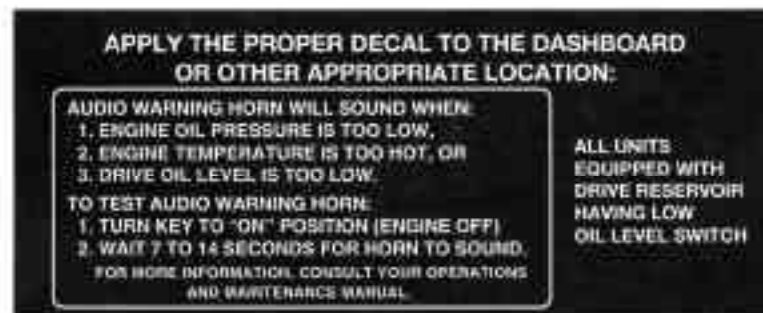
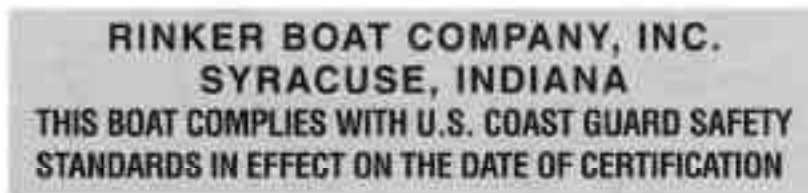
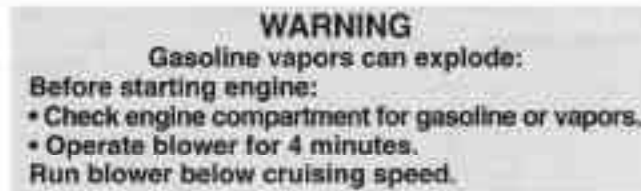

ELECTRICAL SYSTEM

• 12 VOLT DC

A battery supplies power to the 12 Volt DC system. If provided, the voltmeter on the instrument panel in the dash shows the charge level of the battery. The power from the battery is supplied to the 12 Volt DC breaker panel on the helm dash. Figure 3.2 is a typical electrical schematic.

The battery's negative terminal is connected to the grounding studs of the engine. This type of negative ground system is the approved system for marine DC electrical systems. If additional equipment is to be added to your boat it must be adaptable to the negative ground system. When installing additional equipment, be sure to specify that each item's current supply must be taken from the 12 Volt DC circuit breaker panel. If additional circuit protection is required, it must be added at the circuit breaker panel.

NOTE: Power feeds for accessory equipment must NOT be taken from the voltmeter terminals. Consult with your Rinker dealer for additional DC power needs on your boat.

IMPORTANT: Be sure to protect all electrical components from rain, water, or sea spray.

Battery

The battery installed on your boat, by your Rinker dealer, is completely sealed using an absorbent electrolyte principle. The battery is charged through the engine-driven alternator.

DC Lighting

See your Rinker dealer for information regarding bulb replacement.

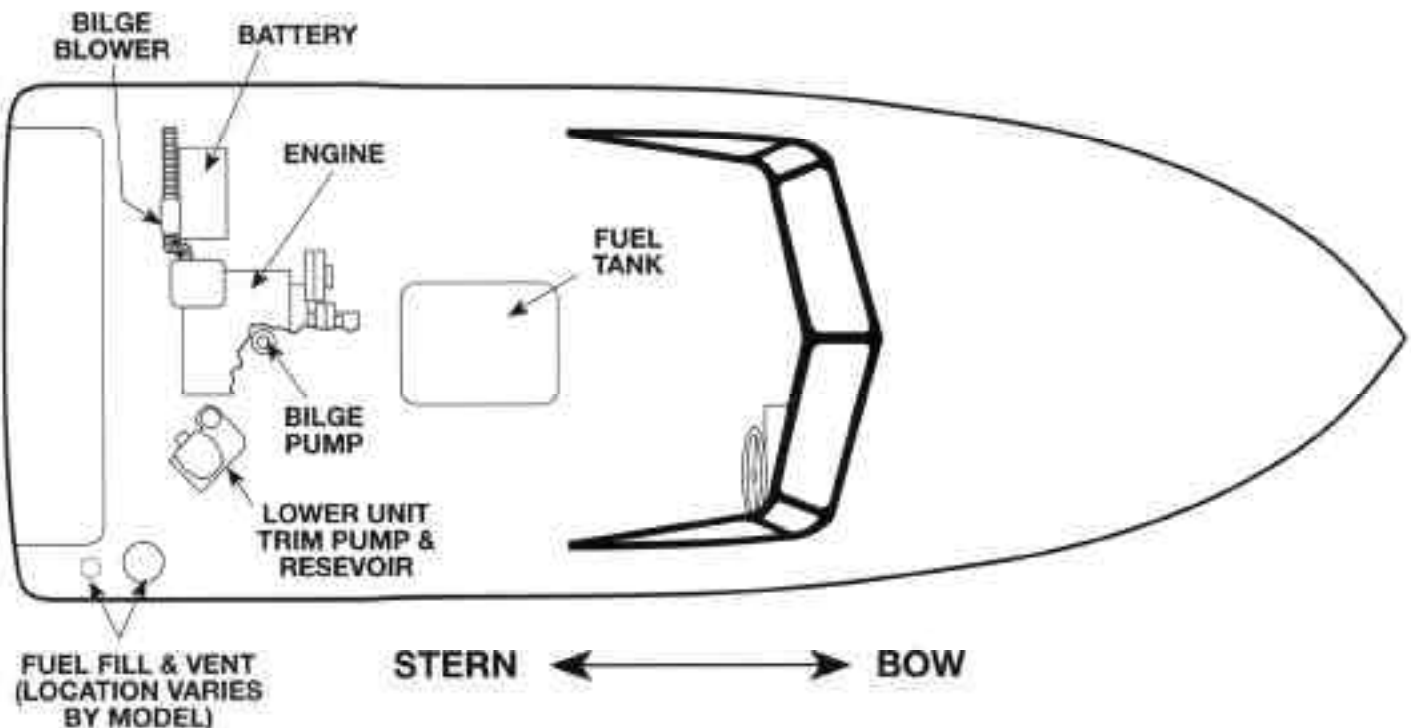

FIGURE 3.1 EQUIPMENT LOCATOR

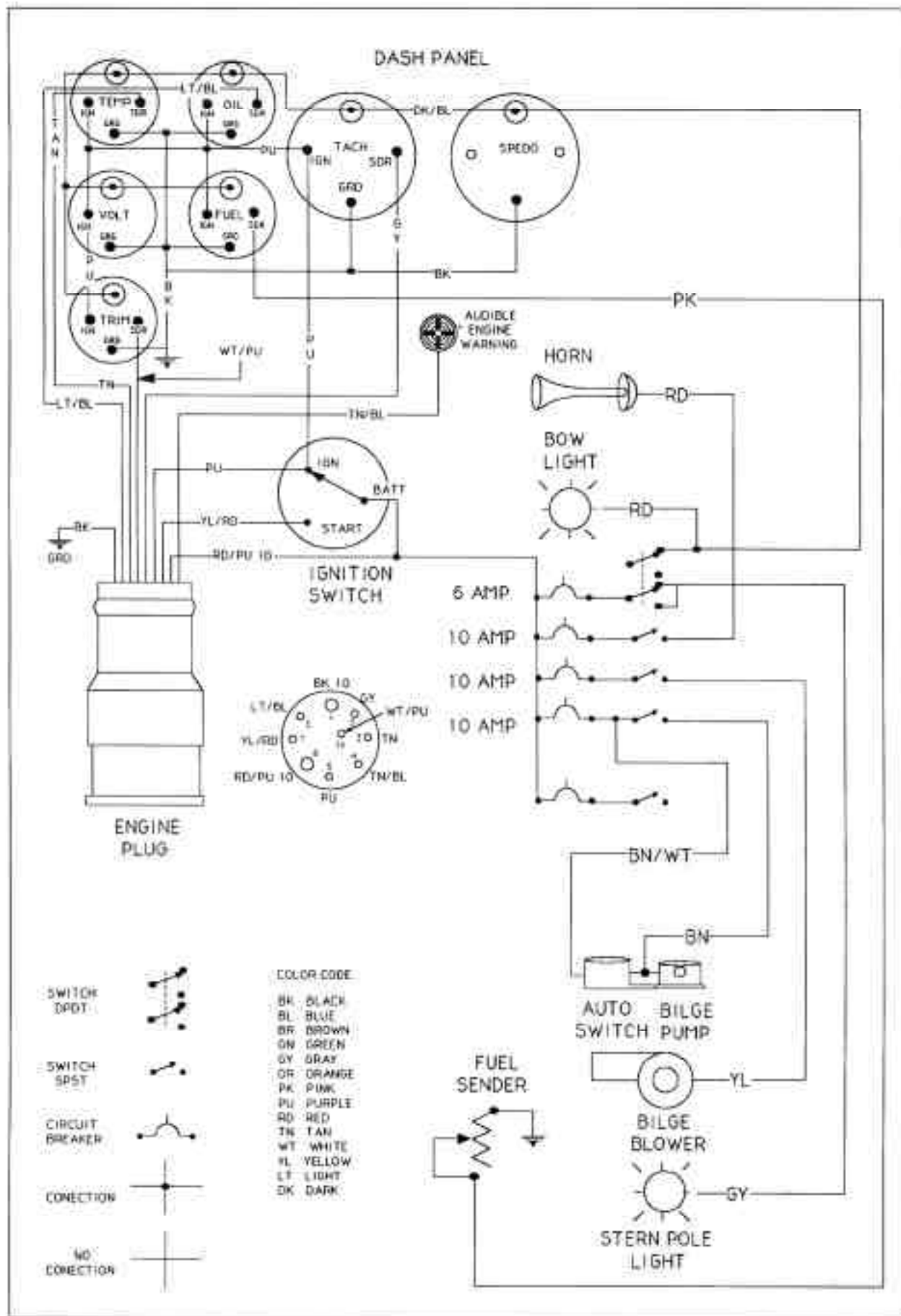

FIGURE 3.2 DC SCHEMATIC WIRING DIAGRAM

FUEL SYSTEM

The internal fuel system on board your Rinker boat meets current Federal requirements at the time of manufacture. The fuel system was assembled with the best materials and components available. Fuel systems on cuddy and runabout models have an anti-siphon valve and a remote fuel gauge.

NOTE: See the engine owner's manual for safety precautions and detailed operation, maintenance, and winterizing instructions.

ENGINE EXHAUST SYSTEM

The engine exhaust system removes harmful gas created by the engine during combustion. Inspect the system for leaks before each use of the boat. Make sure all hose clamps and connections are tight and there are no cracks in any exhaust system component that would allow carbon monoxide gases to escape.

INSTRUMENTATION AND CONTROLS

The full set of instruments installed on your Rinker boat show what is taking place within your engine and related systems. When you take delivery of your boat, ask your Rinker dealer about the normal readings of the gauges. This will provide you with a reference point to evaluate how well your boat is operating. Keep in mind that the readings on some gauges tend to fluctuate. You should investigate the cause for gauge readings that show a continuous variance or a sudden, substantial variance from normal readings.

The instrument panel at the helm has circuit breakers that control the operation of DC equipment on your boat.

Engine Systems Alarm

Some engine models are equipped with a systems alarm. One of the following problems will activate the alarm:

1. High engine temperature
2. Low oil pressure

3. Low outdrive oil level

Refer to your engine owner's manual or check with your dealer to determine whether your engine is equipped with this alarm.

Fuel Gauge

The fuel gauge shows the amount of fuel in the fuel tank. Be aware that the actual fuel supply may vary slightly from that shown on the gauge. The most accurate reading of the fuel gauge is at idle speed when your boat maintains an approximately level position. While underway, the fuel gauge will usually indicate that the tank is fuller than it actually is because the bow is higher than when the boat is at rest. Since gauge readings are approximate, they should be compared to the hours of use versus known fuel consumption per hour.

The most common practice for good fuel management is the **one-third rule**. Use one-third of your fuel supply to travel to your destination and one-third to return. Keep the remaining one-third in reserve for emergencies.

Oil Pressure Gauge

The oil pressure gauge will indicate most, if not all, serious engine problems. A preset valve in the oil pump controls the maximum oil pressure. If the gauge indicates a complete loss of oil pressure, **stop the engine immediately** to prevent serious damage.

Check the engine oil level, and add oil if it is low. If the oil level is full, contact your Rinker dealer or a qualified mechanic to rectify the problem. **Do not restart the engine until the problem is corrected.**

Tachometer

The tachometer displays the engine operating speed in increments of 100 revolutions per minute (RPM). The tachometer shows the RPMs necessary under various engine operating conditions. Consult your Rinker dealer if you need more information.

Temperature Gauge

The temperature gauge shows the temperature of the coolant in the engine's cooling system. Always check this gauge right after starting the engine. The water pump on a marine engine draws in raw water, circulates it through the engine's heat exchanger, and discharges it overboard through the exhaust system. If the temperature gauge indicates that the coolant is hot, **stop the engine immediately**. Refer to your engine owner's manual for instructions and corrective action.

Voltmeter

The voltmeter shows battery voltage. If the engine is running at normal speed (1000 RPMs or higher) and the alternator is charging, the reading on the meter will range between 12.0 to 15.5 volts. If the meter reading is high when the engine is not running and the ignition key or switch is ON, the battery is fully charged. Significantly higher or lower readings indicate a battery problem, alternator malfunction, or heavy drain on the battery. Check the charging system and the battery system for the cause of these readings. An oscillating reading shows a loose voltage regulator connection or loose belts. Low voltage readings after stopping the engine indicate a bad battery or a heavy load on the battery. **Refer to your engine owner's manual for proper gauge readings.**

Throttle and Gearshift

The throttle controls the engine operating speed and acts as the gearshift lever to control the forward and aft movement of the boat. (See Figure 3.3) This type of design ensures safe control of the engine with one hand.

Moving the throttle forward of the neutral position engages the shifting mechanism, causing the boat to move forward. Continuing the forward movement increases engine RPMs and increases the speed at which the boat moves through the water.

⚠ WARNING

WARNING: High speed acceleration in reverse can create a wake that could wash over the transom and flood the boat. Gradually increase speed when moving in reverse.

Moving the throttle aft of the neutral position reverses the shift mechanism, causing the boat to move backward. Continuing the aft movement of the throttle increases engine RPMs and causes the boat to move backward faster. When maneuvering at low speeds, you can reverse the throttle (move throttle forward or aft) to control or brake boat travel.

See your Rinker dealer for specific information about the operation of the throttle/shift.

⚠ CAUTION

CAUTION: When shifting between forward and reverse, always pause in neutral for a few seconds before reversing propeller rotation to prevent damage to the drive system.

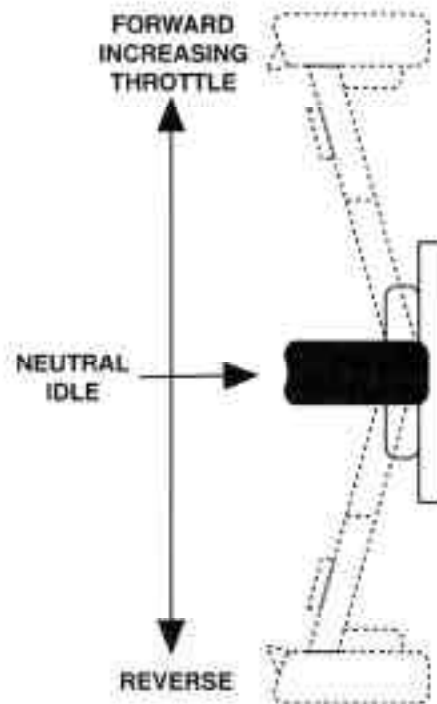

FIGURE 3.3 THROTTLE AND GEARSHIFT

COMPONENTS

WARNING

WARNING: When using electrical components, observe basic safety precautions to reduce the risk of fire, electrical shock, personal injury, or damage to your boat and the component.

Read all operation, maintenance, and safety information in each component's manual before operation. Adhere to all safety precautions in the manual when operating the components.

Rack and Pinion Steering

Your boat has a rack and pinion steering system. Some models have power steering and a tilt steering wheel.

An enclosed cable system connects the steering wheel to the stern drive. Check the cables regularly and tighten them as needed.

Power steering provides positive steering control while providing you, the operator, with the steering sensitivity and the "feel" needed for good steering control.

Getting the "feel" of your boat's steering system is important. Steering does vary from boat to boat depending on the shape of the hull, the type of engine, water and wind conditions, and the load. Turn the wheel from full left to full right. Check that the drive unit is turning correctly, freely, and smoothly. The cable output end of the steering system should be clear of fuel lines, control cables, electrical wiring, and outboard gear when an engine is moved through its full operating range.

NOTE: Your boat has power steering equipment. Refer to the engine owner's manual for detailed information regarding steering system operation and maintenance.

Porta Potti

A self-contained porta potti is standard equipment on some models. See the manufacturer's manual for safety precautions and detailed operation and maintenance instructions.

Automatic Bilge Pump

All Rinker inboard/outboard models have an automatic bilge pump. Figure 3.1 shows its typical location. A float switch controls pump operation. The bilge pump removes water from the bilge. If the pump motor runs but does not remove any water, the pump intake may be clogged. If no visible debris is clogging the pump and water is still not being removed, inspect the discharge hose for kinks or an obstruction.

NOTE: The Federal Water Pollution Act prohibits the discharge of oil or oily waste into or upon the navigable waters and contiguous zone of the United States if such discharge causes a film or sheen upon, or discoloration of, the surface of the water, or causes a sludge or emulsion beneath the surface of the water. Violators are subject to a penalty of \$5000.

Bilge Blower

The bilge blower forces explosive fumes out of the engine compartment by drawing fresh air in through the deck vents. Figure 3.1 shows the blower's location. The bilge blower must be running four minutes before and while you are starting the engine, and while the boat is operating below cruising speed.

WARNING

WARNING: Never assume that operating the blower removes all explosive fumes from the engine compartment. If you smell any fuel, shut down the engine, all electrical components, and immediately determine the source of the smell.

Running/Navigation Lights

If you boat at night, the law requires that you turn on your boat's running lights. Your Rinker boat has one white (mast), one red (port), and one green (starboard) light. Check the running lights periodically for proper operation. If you set out on a boating excursion during daylight hours and will be returning at night, check the lights before you leave port.

The mast light is a removable pole light. To use the light, line up the two-prong plug in the pole with the receptacle in the base. Plug the light in, and lock it into place with lever/slide lock. When not in use, stow the light inside your boat for safe keeping.

You will probably see various running light combinations for the types of vessels you encounter while boating. You should learn to identify what they are and what type of vessel they are associated with. Participation in a "safe boating" course will help you learn more about boating safety and help develop your navigation skills.

The running/navigation lights are controlled by a three-position rocker switch at the helm. This switch allows you to turn all lights off, turn on only the mast light when your boat is anchored or moored, or to turn on all three lights while underway.

Compass

The compass is standard equipment on some models and optional on others. After all equipment has been installed at the helm, a qualified compass adjuster should compensate for the deviations caused by iron, steel, magnets and electrical wiring in the helm area. Even after the compass is adjusted, there will be slight deviations. The adjuster will give you a deviation card or chart showing you how the deviations will affect a compass course. See the manufacturer's instruction manual for safety precautions and for operation and maintenance instructions.

⚠ WARNING

WARNING: Other equipment near compass can cause erroneous readings. Compensator must be adjusted by trained professional to ensure accuracy. Always make a deviation table and use it when navigating with compass. Consult your dealer for more information about using and adjusting the compass.

The compass is a delicate instrument. After the compass has been adjusted, keep all metal or electrical items at least three feet away from the compass. For example, placing a screwdriver or wrench on the helm next to the compass, even for a minute or two, can affect its magnetic field and result in incorrect readings.

To prevent damage to the compass, use only water and a soft cloth to clean the compass housing.

Electric Horn

An electric horn is standard on all inboard and outboard Rinker models. See the manufacturer's instruction manual for proper operation, maintenance, and safety precautions.

AM/FM Cassette Marine Stereo

All Rinker inboard/outboard models are equipped with an AM/FM stereo receiver with cassette tape player. The system has electronic circuits especially designed for radio reception on both AM and FM bands. Your boat has stereo speakers either above or below deck.

NOTE: Features may vary on some stereo models. See the manufacturer's manual for a list of features for stereo installed on your boat. The manual also has detailed instructions for using your stereo safely.

Depth Finder

A depth finder is standard equipment on some models, refer to the depth finder owner's manual for detailed information covering proper operation.

This chapter provides basic information for a typical boating excursion from launching to returning to port. All boaters are responsible for their own safety and the safety of others. Even though you may be an experienced operator, you can still benefit from reviewing the basic boating principles discussed in this chapter.

NOTE: This chapter may refer to equipment and components that are standard on some models and optional or unavailable on other models.

TRAINING COURSES

Rinker Boat urges you to attend the instruction classes and boat safety courses sponsored by the U.S. Coast Guard and other organizations. They provide owners and operators the opportunity to gain knowledge and experience in a variety of skills such as those listed below:

- Safety at sea
- Radio communication
- Using distress signals
- Using lifesaving equipment
- "Rules of the Road"
- First aid
- Federal, state, and local regulations
- Predicting the weather
- Survival in bad weather
- Respect for others on the water
- Pollution control
- Understanding your boat and its systems
- Seamanship
- Boat handling and navigation
- Leaving or approaching a dock or mooring
- Anchoring and weighing anchor
- Handling mooring lines and tying up
- Responding to fire, flooding, collision, and other emergencies

TRANSPORTING

A correctly selected trailer supports your boat properly, makes towing safer, and makes unloading and loading in varying weather conditions easier. Improper trailering is one of the major causes of damage to the hull. The warranty does not cover damage of this type. See Chapter 1 for more information about trailer selection and use.

These are some general guidelines for safe trailering of your Rinker boat.

1. Always check local and state laws for legal towing speeds and other requirements such as licensing, lighting, brakes and turn signals. Requirements may vary from state to state.
2. If the weight of the boat and equipment is not properly distributed on the trailer, the trailer may sway or fishtail while being towed. Swaying or fishtailing can result in damage to the boat, trailer, or towing vehicle and can be very dangerous at higher highway speeds.
3. To prevent damage to the hull, make sure the rollers or bunks support a large hull surface area. Distribute the weight of the boat and equipment evenly on the trailer.
4. To prevent wind damage to a boat with a convertible top, do not tow it with the top up. Also, some mooring covers are not intended for use while trailering. Check with your Rinker dealer for more information.
5. Always remove the bilge drain plug while trailering your boat. **Be sure to install it before launching.**
6. Make sure the overall height of your boat while it is on the trailer does not exceed legal limits.

LAUNCHING

Launching your boat will require that you back the trailer down the launch ramp. If you do not have experience in backing a trailer, practice before you get into a confined launch site. Take your trailer to an open area, and have someone guide you. Learn to back the trailer as straight as possible. Remember that if you want the trailer to move right or left, you must turn the steering wheel in the opposite direction. For example, if the trailer needs to go to the right, turn the wheel to the left.

NOTE: For more specific information refer to your trailer owner's manual.

Here are some tips to remember when you are putting your Rinker boat in the water:

1. Prepare for launching **before** backing your boat onto the ramp.
 - Remove stern tiedowns.
 - Store all loose gear properly.
 - Inventory your safety equipment.
 - Lock winch and trailer unit.
 - Tilt drive unit up to clear the ramp.
 - Disconnect trailer wiring - car to trailer.
 - Install boat's drain plug if not already in place.
2. Have someone at the ramp give you directions. Back slowly down the ramp. Always remember to launch your boat at a right angle to the shore.
3. When the boat's transom is in several inches of water, stop the towing vehicle. Turn off the engine with transmission in first gear (manual transmission) or PARK (automatic transmission). **Set the hand parking brake.**
4. Attach lines to the bow and stern of the boat. Disconnect winch cable and move the boat down the trailer and into the water. Tie boat to the pier.

NOTE: To keep the boat from drifting away, a person on shore should hold the other end of the bow line until the boat is tied to the pier.

5. Lower drive unit into water.
6. Pull your vehicle away from the launch ramp. Park your vehicle in a designated area. Be sure you do not block access to the launch ramp.

FUELING

If possible, fill your boat's fuel tank before loading passengers and gear. If passengers are on board, have them leave the boat until fueling is complete.

DANGER

DANGER: Fuel leaking from any part of the fuel system can lead to fire and explosion that can cause serious bodily injury or death.

IMPORTANT: Remember that if 1/2 pint of gasoline explodes, it has the same power as 15 sticks of dynamite.

Inspect fuel system for leakage, weakening, hardening, swelling or corrosion of components including fuel tanks, fuel lines, fittings, fuel filters, and carburetors. If any component shows signs of leakage or deterioration, it must be replaced before starting the engine.

WARNING

WARNING: Do not use fuels containing any form of alcohol or alcohol derivatives. Alcohol destroys marine fuel system hoses and components. Weakened hoses can lead to hazardous leaks, fire, or explosion.

Rinker Boat recommends the use of alcohol-free gasoline when possible because of the adverse effect of alcohol on fuel system components. If only gasoline containing alcohol is available, or the presence of alcohol is unknown, you must inspect the system more frequently.

Preparing for Fueling

⚠ DANGER

DANGER: Fuel vapors are explosive and can become trapped within the lower portions of the boat. All hatches, windows, doors, and compartments must be closed while fueling your boat.

1. Securely moor boat to dock. Stop engine.
2. Turn off all electrical equipment, engines, generator, air conditioner, appliances, lights, bilge pump and blower, etc.
3. Put out all cigarettes, cigars, and pipes. Do not use anything that can produce a spark or flame.
4. Close all hatches, windows, doors, and compartments.
5. Make sure a fire extinguisher is readily available.

Filling the Tank

1. Always fill tank in an area having adequate lighting. You may not see gasoline spills under poor lighting or in darkness.
2. Remove fuel fill cap from through-hull fitting on transom. Insert fuel supply nozzle. Keep nozzle in contact with metal fill plate (if provided) while fueling.
3. After pumping approximately 10 gallons of fuel into tank, inspect engine and fuel tank area for signs of fuel leakage. Continue fueling if you do not find any leaks or other problems.
4. Stop filling tank before fuel overflows. Allow space at top of tank for thermal expansion. Fuel pumped from underground tanks is cooler than outside air. Gasoline expands as it warms up and can easily overflow tank.

If fuel cannot be pumped into the tank at a reasonable rate, check for a plugged fuel vent or a kink in the line.

After Fueling Procedures

1. When you have finished fueling, replace fuel fill cap. If necessary, wash off any fuel spilled around fuel fill area. Properly dispose of rags used to wipe off fuel spillage.
2. Open engine compartment and all hatches, windows, doors and compartments closed during fueling. Inspect these areas for fuel fumes or fuel line leakage. Investigate and correct any indication of fumes or fuel leakage **before** starting engine.
3. Run bilge blower for at least five minutes before starting engine. Continue to run bilge blower until boat is underway and has reached cruising speed.

LOADING PASSENGERS AND GEAR

⚠ CAUTION

CAUTION: Overloading and improper distribution of weight are significant causes of accidents. Capacity plates, located near the helm, show maximum loads under normal conditions. Give yourself an added margin for safety in turbulent waters. **Overloading is a violation of U.S. Coast Guard regulations. Boats under 20 feet (6.1 meters) long are subject to U.S. Coast Guard safe loading and labeling requirements.**

The U.S. Coast Guard requires that a plate stating the maximum load capacity be affixed to boats up to 20 feet long. This plate shows the load in pounds (persons and gear) the boat can carry safely under normal conditions. The U.S. Coast Guard establishes these load capacity ratings. (Boats over 20 feet long are not subject to U.S. Coast Guard safe labeling requirements.)

You, the operator, are responsible for using common sense and sound judgment when loading your boat. Pleasure boats tend to remain stable under most operating conditions because of their beam, draft, and weight

displacement. **Remember that overloading and improper distribution of weight are significant causes of accidents.** Keep weight below maximum limits for safety in turbulent waters.

When loading your boat, remember to distribute the load evenly and keep the load low. When loading your boat, always **step** onto the boat, never jump. Have someone on the dock pass your gear aboard. Secure all gear firmly so that it will not move or interfere with boat operation. **Be sure all required safety gear is aboard your boat in an easily accessible location.**

CAUTION

CAUTION: Wet surfaces can be slippery. Passengers should wear adequate deck shoes while boarding and underway to avoid accidental slipping and injury.

Passengers should board the boat one at a time and find a seat. Passengers should remain seated during loading of the boat to maintain an even trim. Do not allow passengers to ride on the bow with feet hanging over the side or to ride sitting on the stern or gunwales. Falling from moving boats is a major cause of fatal recreational boating accidents.

CAUTION

CAUTION: Driver's vision must not be obstructed by passengers seated in the bow rider area.

The way passengers are seated and gear is stowed in your boat affects your boat's performance. To get the best performance, drive it as nearly parallel to the water as possible. On planing-type boats, place more weight in the stern to **slightly** raise the bow.

Minor deficiencies in your boat's ride can be quickly corrected by shifting passengers or gear forward or aft. Shifting passenger or gear weight changes the planing angle of the hull or the thrust of the propeller. This has the same effect as changing the angle on the drive unit. By taking a little extra time to carefully place such items as coolers, water jugs and the anchor, you will create a more desirable trim.

STARTING THE ENGINE

The following information is merely a guide and not intended to explain in detail all starting procedures and instructions. **Refer to the engine owner's manual for detailed pre-start and starting instructions.**

1. Secure the boat to the dock or mooring slip before attempting to start the engine.

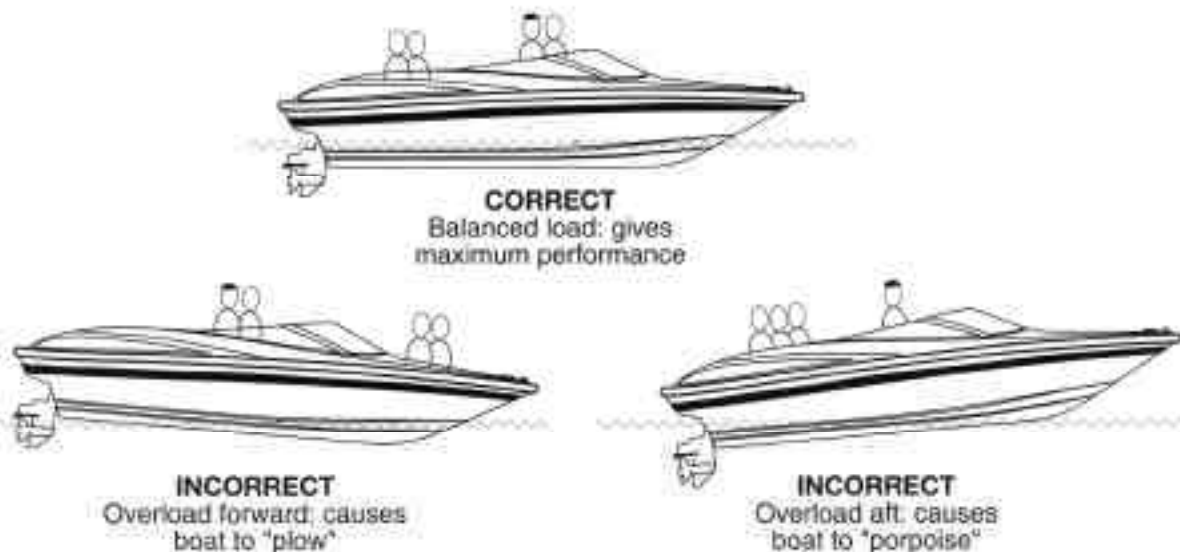

FIGURE 4.1 LOADING PASSENGERS AND GEAR

2. Check engine oil level.
3. Check fuel supply to ensure you have enough fuel for your expected travel plan.

▲ DANGER

DANGER: Gasoline vapors are highly explosive. To prevent a possible explosion and fire, check engine and fuel compartments for fumes or accumulation of fuel before each engine start. Always operate bilge blower for at least four minutes before starting engine.

4. Inspect fuel, oil, coolant, exhaust, and power steering systems for leaks.
5. Always operate bilge blower for at least four minutes before starting engine.
6. Operate bilge pump until flow of water stops.
7. Make sure throttle is in neutral position.
8. If you are starting a cold engine, advance the throttle several times and leave it in the SLOW/START position. This will actuate the carburetor accelerator pump and feed fuel to the engine. Ask your dealer to show you the proper use of throttles.
9. If your engine is equipped with electronic fuel injection, the throttle lever should be left in the neutral position during cold or warm starting.
10. Turn ignition key to START position to start engine.

NOTE: Engine will not turn over if throttle is not in the neutral position. If engine does not turn over, throttle may not be in neutral. Move throttle lever up and down slightly and try again.

▲ CAUTION

CAUTION: Do not operate starter continuously for more than 15 seconds without pausing. Allow starter to cool between start attempts. See engine owner's manual for details.

11. If engine fails to start, wait one minute. Move throttle only once to maximum position, then back to neutral. Try to start engine again.
12. Run engine approximately one to two minutes at fast idle speed (1200 to 1500 RPM) to warm up engine. Keep boat secure at dock until engine is warmed up.
13. If your engine is equipped with electronic fuel injection, there is no need to actuate the throttle during engine warm up. Engine idle speed will be controlled automatically by the electronic fuel injection system.

LEAVING THE DOCK

After the engine has warmed up, you are ready to leave the dock. Before you cast off, check all gauges for proper readings. If oil pressure reading is abnormally low or temperature reading abnormally high, **stop engine immediately**. Check that charging system is working properly. Voltmeter should read between 12 to 15 volts. Check again for fuel, oil, and exhaust leaks. Correct the cause for any abnormal condition or gauge reading before getting underway.

Check the operation of the steering by turning the steering wheel to full port and to full starboard while observing outdrive movement. With boat still securely moored to the dock and engine idling at 600 to 800 RPM, move the throttle forward, then aft, then back to neutral to check for proper shifting. Then cast off mooring lines and stow fenders.

▲ CAUTION

CAUTION: Make sure passengers sitting in the bow area do not obstruct the operator's vision when casting off and while underway.

▲ CAUTION

CAUTION: Before getting underway, close and latch walk-through windshield to prevent personal injury or damage at higher speeds.

When you are sure your boat is ready, check wind, tide, and current or other forces that will affect the way you maneuver your boat away from the dock. Shift your boat's engine into forward or reverse depending on whether you want to move the bow or the stern away from the dock first. Move the throttle lever to neutral. Then push forward quickly and firmly to shift into forward gear or push backward to shift into reverse. Your engine should be running at a slow speed as you move away from the dock. If you move the bow out first, watch that the swim platform does not swing into the dock or a piling.

CAUTION

CAUTION: Deck areas and swim platform are slippery when wet. Passengers must be careful when passing through companionway to prevent accidental slipping or tripping. Passengers should wear adequate deck shoes at all times to prevent accidental slipping. Passengers must stay off swim platform while underway to avoid falling overboard.

STEERING

Watch the stern when you turn! Steering a boat is like driving a car on slippery pavement. When you turn the steering wheel, the stern responds first by swinging in the opposite direction of the bow. When you are leaving the dock or trying to avoid an object in the water, this swing can be critical.

Always give yourself plenty of room to make a turn. You should also slow the speed of your boat while turning. Never make sharp, fast turns because you can easily lose control of your boat. Remember that your passengers should be seated whenever you are making a turn.

ACCELERATING

CAUTION

CAUTION: Acceleration at full throttle is not recommended during the first 20 hours of engine operation. This engine "break-in period" coincides with the 20-hour engine checkup.

When you throttle up and accelerate, your boat increases the trim angle which causes the boat to ride bow high as shown in Figure 4.2. The maximum angle is commonly known as the "hump." Get over the hump as quickly as possible because visibility, handling, and performance are limited. It should only take a few seconds at full throttle for your boat to level out at its planing attitude. Then, accelerate until you reach a comfortable plane and throttle down to cruising speed. This also will provide for better fuel efficiency.

WARNING

WARNING: High speed acceleration in reverse can create a wake that could wash over the transom and flood the boat.

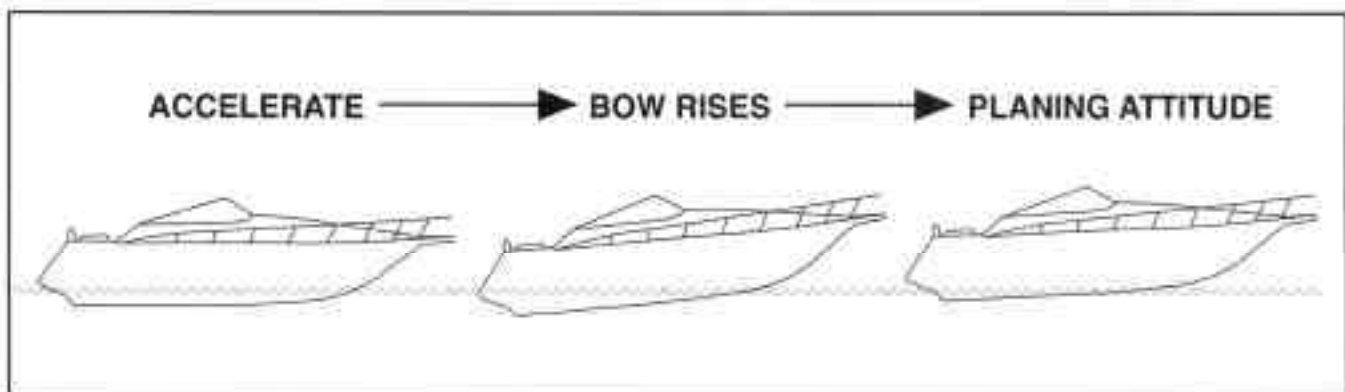

FIGURE 4.2 ACCELERATION

TRIMMING

Power Trim Drive Unit

NOTE: Refer to your engine owner's manual regarding the power trim controls installed on your boat.

CAUTION

CAUTION: Never trim drive unit up/out using TRAILER switch while boat is underway. Use extreme caution when operating with drive unit raised. Severe damage to drive unit may result if unit is raised beyond the gimbal ring support flanges at engine speeds above 1200 RPM.

The drive angle of the boat is the relationship of propeller thrust to the planing surface of the hull's bottom. The performance of the same boat under varying conditions can be improved by adjusting the drive angle.

By gradually shifting the drive unit from its innermost adjustment towards the outermost adjustment, the propeller thrust will change. It will push in a downward motion and tend to lift the bow. (See Figure 4.3)

Move the drive unit angle towards its innermost adjustment, and the propeller is brought in as close as possible to the transom. The angle of the propeller will cause an upward thrust and the boat's bow will be pushed downward.

After reaching plane, under certain load conditions, your boat could have a tendency to bury its forward V-ed section. The boat will begin to plow and lose speed. If the water is choppy the boat will yaw. A boat will spin out if its bow is excessively buried. The only way to correct this situation is to increase the angle and swing the drive unit outward.

When the drive unit is extremely angled out, your loaded boat will be sluggish in coming to plane. Once on plane, it will tend to porpoise. Correct this motion by moving the propeller inward. This will decrease the angle between the drive shaft and transom.

Very often, the optimum drive unit angle setting for the highest speed while carrying a light load will be just short of the porpoise point. However, such a setting is unsuitable when you have a heavy load or are pulling skiers. By reducing the drive unit angle, the boat operator will find it easier to maneuver the boat and to pull skiers to the surface.

To adjust to the ideal boat angle for given load and water conditions, the drive unit must be trimmed. The drive unit has an adjustable trim range. The best all-around performance attainable is when the drive unit is adjusted to allow the boat to run at an angle between 3° and 5° to the water.

STOPPING

You cannot stop a boat as quickly as a land vehicle because a boat has no brakes. Stop the boat by allowing it to slow down to less

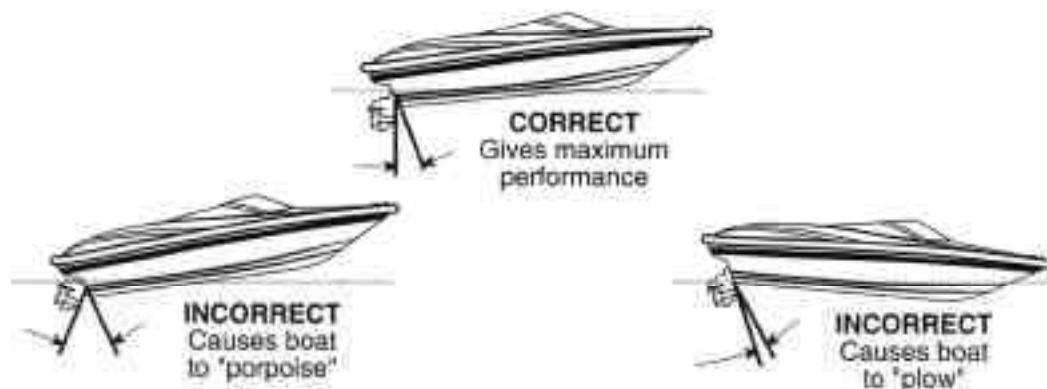

FIGURE 4.3 TRIMMING

than 5 miles per hour. Then, put the engine in reverse. By slowly increasing reverse power, you can stop the boat in a short distance. Remember that the boat does not respond to steering in reverse as well as it does when going forward.

ANCHORING

If you stop for recreation or an emergency, you must anchor your boat. The size and weight of your boat govern the weight of the anchor and the diameter of the anchor line. A burying anchor, such as a Danforth or plow anchor, grips into the bottom and holds your boat secure. Holding power should be more important than weight. Your Rinker dealer can help you select the proper anchoring equipment.

The length of the anchor line should be six to eight times the depth of the water to assure that the anchor bites into the bottom. The bottom end of the anchor line should be galvanized chain which holds up well as the line moves back and forth on the bottom. The rest of the line should be nylon anchor line which stretches to soften the impact of wind and waves on your boat.

WARNING

WARNING: Keep anchor secure while underway to prevent damage or injury if boat's attitude changes suddenly.

These are some general guidelines for anchoring your boat:

- Always anchor from the bow; never anchor from the stern. Anchor lines may become fouled in the drive unit. A slight current may make the boat unsteady.
- Secure the anchor line to the deck cleat. Do not tie line to hardware not designed to support this stress.
- Use more than one anchor if you are anchoring overnight or for an extended period of time. If you use only one anchor, make sure your boat has enough space to swing full circle in case of shifting winds.

- Keep the anchor and line in an area where it will be readily available in an emergency.

Dropping Anchor

1. Have a crew member carefully **lower** the anchor, keeping a slight tension on the line as the anchor drops. Maintain tension after the anchor reaches the bottom. Simply throwing the anchor overboard usually fouls the line and requires starting over.
2. Maneuver the boat slowly aft until the proper length of line is run out.
3. Fasten the anchor line around the deck cleat. Anchor flukes should dig into the bottom and hold boat in position.
4. Check shoreline landmarks when you drop anchor. Check the position of the landmarks again 30 minutes later. If your boat's position has changed, the anchor is dragging and must be reset.

Weighing Anchor

Weighing, or pulling in the anchor, requires moving the boat towards the anchor and pulling in the anchor line as the boat moves. When the line is vertical, pull up firmly on the anchor line to free the flukes from the bottom. If the anchor remains stuck, feed out a few feet of line and attach it to the bow cleat. Maneuver the boat around the anchor, keeping the line taut until you find an angle that will pull the anchor free.

DOCKING

As you approach the dock or other mooring area, slow your boat down in time for the wake to subside before it reaches other boats or docks. As you get close to the dock, slow down to idle speed. Check for wind or currents, and allow them to carry the boat toward the dock if you can. When approaching, check that fenders are lowered and lines are attached to the cleats on the mooring side. Be sure fenders are at the proper height. If you can, have one person at the stern and one person at the bow, each with a boat hook and a mooring line attached to a cleat.

Approach the dock at idle speed and at approximately 45°. When the bow is within a few feet of the dock, bring the stern alongside the dock. Turn wheel in opposite direction. Then, put the engine in reverse to bring the stern closer to the dock.

MOORING

After you have positioned your boat next to the dock, you must secure it with mooring lines to keep it in position. Mooring lines must be long enough to secure your boat in any docking situation. For example, the length of the lines for a 16-foot runabout should be at least 15 feet. An eye splice at the end of each line works well with bow or stern cleats.

The mooring lines you will use most often are the bow line, the stern line, and spring lines. Each line has a specific purpose. The bow line and the stern line secure your boat's bow and stern. The two spring lines keep your boat from moving forward or backward when you are moored alongside a dock.

If you are mooring your boat for a short time, bow and stern lines may be the only lines you will need. If you are mooring your boat for a longer time or the currents are swift, you should use spring lines. The stern spring line leads from the boat's stern cleat forward to the piling or cleat on the dock. The bow spring line leads from the bow cleat aft to the dock.

If you are mooring your boat in a slip, bow and spring lines, port and starboard, will keep your boat in position.

NOTE: If tides are a consideration, be sure to leave slack in the lines to make up for the rise and fall of the water while your boat is docked.

GOING ASHORE

While mooring your boat, allow engine to idle with drive in neutral. After turning off the engine, run bilge blowers for a few minutes to circulate fresh air through the engine compartment. Before going ashore, make sure all electrical components are turned off to prevent draining the battery.

ADDITIONAL UNDERWAY INFORMATION

- Be sure to run the bilge blower whenever the boat is operated under cruising speed.
- Keep all bilge blower and engine compartment vents free of obstructions to allow proper ventilation.
- Always be aware of local laws on noise limits. Noise means engine noise, radio noise or even yelling by people on your boat. Good seamanship demands that you operate your boat quietly so as not to infringe on the rights of others. Don't use thru-transom exhaust unless you are well off shore.
- You are responsible for any damage or injury caused by your boat's wake. Observe no wake speed zone warnings. Operate your boat with regard for the safety of other boats and people in your boating area.
- Keep your engine well tuned to decrease exhaust hydrocarbon emissions that pollute the air and water.

Rinker Boat recommends that maintenance and repairs be performed by an authorized Rinker dealer. Your dealer is qualified to make repairs or modifications to your boat in such a manner as to not compromise safety, design integrity, or warranty coverage. However, some owners may prefer to perform routine maintenance and repairs themselves. For those individuals, this chapter includes basic procedures for general maintenance and repairs.

IMPORTANT: Always refer to the manufacturers' manuals for detailed maintenance and repair procedures. If information in this manual conflicts with information in the manufacturer manuals, the manufacturer manuals must take precedence. Do not attempt any repairs on your boat unless qualified to do so. Only use approved marine replacement parts available from your dealer.

ENGINE

Checking and Adding Oil

NOTE: During the engine 20 hour break-in period, Rinker Boat recommends the oil level be checked after every two (2) hours of engine running time.

To check oil:

1. Ensure boat is in the water and engine is stopped.
2. If the engine is warm, let it cool for ten minutes to allow the oil to drain back into the engine oil pan and provide for a more accurate check.
3. Pull engine oil dipstick out of its sleeve, wipe clean, and push dipstick back into the sleeve. Make certain that the dipstick is pushed all the way back into the sleeve.
4. Pull dipstick out again, check oil level on dipstick. The oil level must be between the ADD and FULL marks on the dipstick.
5. Add oil if oil level is at or below the ADD mark.

6. Push dipstick back down into the sleeve. Make sure it is properly seated all the way down.

To add oil:

1. Remove oil fill cap from valve cover.
2. Add oil as required to raise the oil level up between the ADD and FULL marks on the dipstick. **Do not** overfill. One quart (.95 liter) of oil will be required if oil level was at the ADD mark. Adjust amount of oil being added if oil level was below ADD mark.
3. Check oil level after adding oil.

NOTE: Use a funnel when adding oil to prevent oil spills and help keep your engine free of surface grime and dirt.

CHANGING OIL AND OIL FILTER

WARNING

WARNING: The Federal Water Pollution Control Act prohibits the discharge of oil or oily waste into or upon the navigable waters of the United States or the waters of the contiguous zone if such discharge causes a film or sheen upon or a discoloration of the surface of the water or causes a sludge or emulsion beneath the surface of the water. Violators are subject to a penalty of \$5,000.

1. Run engine long enough to bring water temperature gauge up to NORMAL operating temperature. Stop engine.
2. Place a container (large enough to avoid spills) under drain plug on crankcase.
3. Slowly remove oil drain plug. Allow all oil to completely drain out of crankcase.
4. Slowly unscrew filter in a counterclockwise direction and remove oil filter and filter ring. Properly dispose of old oil filter and filter ring.

- Carefully screw the new oil filter and filter ring into the opening by hand.

IMPORTANT: Do not cross thread the new filter when installing. This will create possible leaks and damage the threads on the engine.

- Use an oil filter wrench to tighten securely 1/2 turn.
- Reinstall drain plug by hand. Then tighten 1/2 turn with a wrench.
- Fill crankcase with proper grade and viscosity oil. (To add oil, refer to Checking and Adding Oil Check procedure on page 5-1.)

▲WARNING

WARNING: Be careful when changing the fuel filter. Gasoline is extremely flammable and highly explosive under certain conditions. Always STOP engine and do not smoke or allow open flames in area when changing filter.

Changing the Fuel Filter

- Remove fuel filter canister from engine.
- Remove and discard filter elements and sealing gasket.

NOTE: Do not reuse elements or gasket. Always install a new filter.

- Inspect fuel filter canister for signs of corrosion. Replace canister if any corrosion is evident.
- Install filter elements. Coat sealing rings with light coating of oil and install filter canisters. Tighten securely.

▲CAUTION

CAUTION: Make sure that all fuel line connections are tight and that no fuel leaks exist.

- Run engine and check for fuel leaks.

Adjusting Drive Belt Tension

Alternator

Check alternator drive belt tension by pressing down on the belt midway between the engine circulating pump pulley and the alternator pulley. The belt should depress 1/4 inch (6.4 mm). If depression is more than allowable, adjust tension by loosening alternator mounting screws and pivoting the alternator as required to achieve proper tension. Tighten mounting screws.

Sea Water Pump

Check the sea water pump belt tension by pressing down on the belt midway between the crank pulley and the sea water pump pulley. The belt should depress 1/8 inch (3.2 mm). If depression is more than allowable, adjust tension by loosening the sea water pump mounting bolts and slide pump over to achieve proper tension. Tighten mounting bolts.

NOTE: On some models, the sea water pump is inside the drive unit. Rinker Boat recommends replacing the sea water pump impeller every two years to help eliminate pump failures.

NOTE: Some models may come equipped with a single serpentine belt which has an auto-tensioning feature and should not require adjustments.

Tuning Up the Engine

Keeping the distributor, spark plugs, and spark plug wires in excellent condition help assure that you will get the best possible performance from your engine. Tune up the engine every 200 to 300 hours or when engine displays starting or running problems. If you use your boat less the 200 to 300 hours per year, Rinker Boat recommends that a tune-up be performed at least once a year.

NOTE: Refer to the engine owner's manual for detailed information.

Distributor

1. Periodically check the distributor for wear and deterioration.
2. Inspect the distributor cap and rotor for hairline cracks and excessive deterioration of contacts. Replace distributor cap if either defect is noted.
3. If there is dirt or an oily film on the inside of the distributor cap, wash it with household dish washing liquid and warm water. Rinse with clean water and dry thoroughly.

Spark Plugs

NOTE: Before removing spark plugs, mark each plug wire with its corresponding engine cylinder number.

Remove spark plugs and examine one for carbonization. Replace spark plugs every 150 hours of operation or sooner depending on their condition.

Spark Plug Wires

1. Inspect each spark plug wire for deterioration or cracks in the insulation.
2. If any wires need replacement, replace all spark plug wires.
3. Remove and replace only one spark plug wire at a time to avoid crisscrossing the firing order.

NOTE: Replace spark plug wires every two years, even if they appear to be in good working condition. Refer to the engine owner's manual for detailed information.

FUEL SYSTEM

The fuel system is designed to prevent fire and explosion while providing a clean fuel supply to the engine. All fuel systems installed at the Rinker Boat factory meets federal requirements.

NOTE: This information applies only to the fuel system beyond the engine. Any replacement of parts or repairs to the fuel system should be performed by a trained marine

mechanic. See your Rinker dealer for parts and repair.

Inspect the fuel system frequently. Check for leaks and vapors. **Repair any problems immediately.** Keep fuel tank filled during the boating season to prevent moisture condensation.

Monthly Inspection

1. Starting at the fuel tank, inspect the complete fuel system for leaks or vapors.
3. Inspect fuel line fittings, carburetor, and fuel pump. Make sure mounting brackets are tight.
4. Inspect fuel ventilation ducts and clamps for wear or damage.
5. Inspect fuel tank vent screens (located outside of hull) for obstruction.

COOLING SYSTEM

Check that the raw water cooling system pump is drawing in seawater through the stern drive and discharging it overboard through the exhaust pipes.

STERN DRIVE UNIT (I/O)

NOTE: Check the oil level at the frequencies recommended in the stern drive owner's manual. Refer to the manual for detailed information.

1. If necessary, reposition the stern drive unit to level the anti-ventilation plate.

▲WARNING

WARNING: Do not remove oil vent plug immediately after using boat. Oil inside the drive unit becomes hot and expands. Oil will flow out rapidly from the vent plug opening, if oil vent plug is removed. Allow oil to cool before removing plug.

2. When drive unit is cool, remove oil vent plug and o-ring from drive shaft housing.

3. Check oil level. Oil should be touching the bottom edge of the oil vent plug opening.
4. If oil level is low, add correct grade and viscosity as specified in the owner's manual.

▲ CAUTION

CAUTION: No more than 2 ounces (60 ml) of oil should ever be required to bring oil to proper level. If more is needed, the drive unit has an oil leak. Repair the unit immediately.

5. Reinstall the o-ring and oil vent plug and tighten.
6. Make sure your dealer checks the engine alignment during the 20-hour checkup. The engine alignment check should be completed in accordance with the recommended procedures as stated in the engine manual. Failure to do so could result in drive train damage not covered by the warranty. Engine alignment should be checked annually after the 20-hour check.

PROPELLER

The propeller shipped with your boat is the size Rinker Boat recommends for the best overall performance. However, factors such as altitude, temperature, load, bottom growth, and propeller condition can affect your boat's performance. Periodically inspect the propeller for excessive wear and/or damage. Repair or replace, if required.

NOTE: Check with your Rinker dealer regarding your specific performance requirements. Refer to the propeller owner's manual for installation or removal procedures and additional performance-related information.

POWER STEERING SYSTEM

Your boat is equipped with a rack and pinion power steering system. The steering system requires periodic maintenance to be trouble-free and safe. Regular checks of the complete system is essential. (Some engine models do not have power steering as a standard feature. Check with your dealer for details.)

NOTE: Consult your Rinker dealer regarding all repairs or replacement parts. Refer to the steering manufacturer's manual for detailed maintenance and repair or replacement information.

Lubricate, inspect, and perform maintenance every 50 hours of operation or 60 days under normal use or every 25 hours of operation or 30 days under excessive use. Operating boat in saltwater is classified as excessive use.

1. Lubricate control valve through grease fitting with multi-purpose lubricant until grease is visible around rubber boot.
2. Coat power steering output shaft and exposed steering cable end with multi-purpose lubricant.
3. Lubricate cable end guide pivot point with SAE 30W engine oil.
4. Run engine for 20 to 30 minutes. Check power steering fluid level. If level is low, add type "A" automatic transmission fluid to bring level up to FULL mark on dipstick.

NOTE: If engine is cold, the correct fluid level should be at the ADD mark to allow for oil expansion when engine is hot.

5. Inspect all hydraulic lines and hoses for leaks. Make sure all lines and hoses are free from friction and not exposed to any extremely hot parts. Tighten all fittings and clamps as required.
6. Check that all bolts are tight.

7. Check pump pulley drive belt for wear and proper tension. Over-tensioned belts cause bearing failure. Loss of pump pulley drive belt affects steering effort.

CAUTION

CAUTION: Boat steering is not self-centering. Steering is affected by engine and propeller torque, trim tab setting, wave and current action, and the speed of the hull through the water. For safe operation, maintain constant attention and control of the direction of the boat.

BILGE

Inspection

Check the bilge every time you use your boat. A small amount of water in the bilge is usually not a major concern. ***For excessive amounts of water, investigate for water leaks and repair immediately. If the bilge is ever filled with fuel or oil inspect the engine for leaks and repair immediately.*** Dispose of fuel or oil properly. Never pump fuel or oil overboard when your boat is in the water. Doing so violates pollution control laws.

Cleaning

Run bilge until pump is dry. Remove all sand, silt, dirt, or foreign material. Ensure all limber holes are open and strainers are clean. Use bilge cleaner to remove oil stains. Consult your Rinker dealer for recommended types of approved cleaner. **Never** use any flammable type solvents for cleaning the bilge.

The troubleshooting procedures listed in this chapter are designed to correct minor malfunctions for engine, performance, and vibration. Troubleshooting is a process of elimination. The troubleshooting chart displays areas that could be at fault and are presented in the order of probable occurrence.

Use good common sense and always refer to the engine manufacturer's owner/service manual. If the malfunction appears too complicated or unsafe, contact your Rinker dealer. If underway, and contacting your Rinker

dealer is not practical, contact the local marina for information regarding available marine mechanic service.

▲WARNING

WARNING: To avoid personal injury and damage to equipment, disconnect battery cables before inspecting, checking or repairing any component. Do not disconnect or reconnect battery cables if you smell gas fumes. Thoroughly ventilate engine compartment before disconnecting or reconnecting battery cables.

ENGINE

Malfunction	Probable Fault	Solution
Engine will not crank (Ignition system)	<ol style="list-style-type: none"> 1. Throttle lever in wrong position 2. Loose wire in starting circuit 3. Ignition switch defective 4. Defective solenoid 5. Battery switch in OFF position 6. Dead battery 7. Spark plug(s) fouled or broken 8. Distributor broken, wet, cracked, or dirty 9. Lanyard stop switch activated (cord pulled from emergency stop button) 10. Hydrostatic lock 	<ol style="list-style-type: none"> 1. Check position of throttle lever, ensure it is in the "neutral" position. 2. Tighten all wiring connections. 3. Test switch continuity. Replace switch as required. 4. Replace solenoid. 5. Turn selector switch to battery position. 6. Recharge or replace battery. 7. Clean, adjust gap, or replace. 8. If wet or dirty, wipe with cloth and cleaning solvent. Inspect cap for cracks, carbonized paths (inside and out) replace cap as required. 9. Reinstall cord. 10. Remove spark plugs and crank engine. If engine cranks, it indicates that water is getting into the cylinders from the exhaust system or from a possible gasket leak. If water gets into the engine through the exhaust line, it indicates improper draining of exhaust system. Contact your Rinker dealer or a qualified marine mechanic to correct problem.

ENGINE

Continued...

Malfunction	Probable Fault	Solution
Engine cranks but will not start (Fuel system)	<ol style="list-style-type: none"> 1. Lack of fuel 2. Improper starting procedure 3. Clogged fuel filters 4. No fuel reaching carburetor (providing all fuel valves are open) 5. Engine flooded 6. Contaminated fuel 7. Water in fuel tank 	<ol style="list-style-type: none"> 1. Open shut-off valve, clean filters, check fuel level and anti-siphon valve. 2. See Engine Owner's manual to review starting procedure. 3. Check and replace filters. 4. Check fuel pump, fuel pump filter, anti-siphon valve, carburetor fuel filter, and fuel tank line for cracked flanges or restricted fittings. 5. Do not attempt to start engine for at least 5 minutes. For hot engine, fully advance throttle, (make sure throttle lever is in neutral) and crank engine. 6. Have your dealer drain and clean the fuel tank. 7. Check fuel fill and tighten cap if loose. If water is from condensation forming on walls of partially filled fuel tank, see dealer for fuel drying product. If these remedies fail, have dealer draw and clean tank.
Low cranking speed	<ol style="list-style-type: none"> 1. Loose or dirty electrical connections or damaged wiring 2. Bad battery 3. Engine oil too heavy for prevailing temperatures 	<ol style="list-style-type: none"> 1. Check all related electrical connections and wires. 2. Test battery (See Engine Owner's manual). 3. Drain oil and refill with correct grade and viscosity oil. (See Engine Owner's manual).
Starter will not crank engine	<ol style="list-style-type: none"> 1. Discharged battery 2. Corroded battery cables 3. Loose connection in starting circuit 4. Defective starter switch 5. Starter motor brushes dirty 	<ol style="list-style-type: none"> 1. Charge battery, change battery selector switch to "All". 2. Clean terminals. 3. Check and tighten all connections. 4. Replace switch. 5. Clean or replace brushes.
Poor acceleration	<ol style="list-style-type: none"> 1. Defective fuel pump 2. Throttle not fully open 3. Flame arrestor dirty or air intake obstructed 4. Engine overheating 	<ol style="list-style-type: none"> 1. Have dealer replace fuel pump. 2. Inspect cable and linkages for binding, obstructions, or loose fasteners. 3. Clean flame arrestor and check air intake. 4. Determine cause of overheating, consult Engine Owner's manual.

ENGINE

Continued...

Malfunction	Probable Fault	Solution
Engine runs but misfiring	<ol style="list-style-type: none"> 1. Improper timing 2. Fouled spark plug(s) 3. Wet spark plug wires 4. Carbon tracked distributor 5. Loose ignition wires 6. Defective fuel pump 7. Partially clogged fuel filter 8. Incorrect carburetor mixture 9. Contaminated fuel 	<ol style="list-style-type: none"> 1. Check timing and adjust as required (See Engine Owner's manual). 2. Remove, clean, or replace. 3. Wipe dry, inspect and replace damaged wires. 4. Clean or replace as required. 5. Inspect all wire connections. 6. Repair or replace as required. 7. Clean or replace fuel filter. 8. See Engine Owner's manual for proper carburetor adjustment. 9. Drain fuel tank and flush clean and replace fuel filters.
Excessive fuel consumption	<ol style="list-style-type: none"> 1. Restriction in flame arrestor 2. Faulty fuel pump 3. Dirty flame arrestor screen 	<ol style="list-style-type: none"> 1. Remove flame arrestor and clean. 2. Have dealer repair or replace as required. 3. Clean or replace as required.
Blue exhaust smoke	<ol style="list-style-type: none"> 1. Lube level too high 2. Oil too thin 	<ol style="list-style-type: none"> 1. Drain off excessive oil 2. Drain and replace oil (See Engine Owner's manual).
Black or gray exhaust smoke	<ol style="list-style-type: none"> 1. Fuel mixture too rich 2. Choke stuck 3. Carburetor fuel level too high 4. Clogged flame arrestor 	<ol style="list-style-type: none"> 1. Have dealer adjust carburetor. 2. Lubricate and adjust. 3. Have dealer adjust float in carburetor. 4. Clean or replace as required.
White exhaust smoke	<ol style="list-style-type: none"> 1. Engine misfiring 2. Spark plugs dirty or not gapped correctly 	<ol style="list-style-type: none"> 1. See Engine Owner's manual. 2. Clean, adjust gap, or replace.
Low oil pressure	<ol style="list-style-type: none"> 1. Insufficient oil in crankcase 2. Excessive oil in crankcase 3. Diluted or improper grade and viscosity oil 4. Oil leak in pressure line 	<ol style="list-style-type: none"> 1. Check and add correct grade and viscosity oil. Visually check engine for leaks. 2. Check and remove required amount of oil. Check for cause of excessive oil (improper filling, bad fuel pump, etc.). 3. Change oil and oil filter, being sure to use the correct grade and viscosity oil. 4. Inspect all oil lines and tighten all connections as necessary.

ENGINE

Continued...

Malfunction	Probable Fault	Solution
No oil pressure	<ol style="list-style-type: none"> 1. Defective gauge, gauge tube, or oil line 2. No oil in engine 	<ol style="list-style-type: none"> 1. Have dealer replace gauge, or tube, and tighten or replace line as necessary. 2. Fill with proper grade and viscosity oil (See Engine Owner's manual).
High oil pressure	<ol style="list-style-type: none"> 1. Too heavy grade 2. Dirt or obstruction in oil lines 	<ol style="list-style-type: none"> 1. Drain oil and replace with proper grade (See Engine Owner's manual). 2. Have dealer drain and clear oil system. Check for bent or flattened oil lines and replace as required.
Knocking or pinging	<ol style="list-style-type: none"> 1. Incorrect type fuel 2. Incorrect timing 3. Pre-ignition 4. Overheated engine 5. Cooling system trouble 	<ol style="list-style-type: none"> 1. Have dealer drain tank and replace with proper fuel. 2. Have dealer correct timing. 3. Clean or replace spark plugs. 4. Check engine cooling system. 5. Check water intake and connections for leaks.
Rough running	<ol style="list-style-type: none"> 1. Choke not operating 2. Faulty fuel pump 3. Idle speed too low 4. Faulty ignition system components 5. Clogged fuel filters 6. Contaminated fuel 7. Flame arrestor plugged with foreign material or air intake hose obstructed 	<ol style="list-style-type: none"> 1. Check choke linkages for binding or obstruction. 2. Refer to Engine Owner's manual for fuel pump testing procedures. 3. Have dealer check idle speed and adjust. 4. Have dealer service ignition system. 5. Replace filters. 6. Inspect fuel for water or other contaminants. If contaminated. Have dealer drain tank and flush with fresh fuel. 7. Clean flame arrestor and check hose.
Engine overheating	<ol style="list-style-type: none"> 1. Bad sending or receiving unit. 2. Loose wiring connections at sending or receiving unit 3. Worn or broken impeller in sea water pump 4. Clogged oil cooler 5. Exhaust lines plugged 	<ol style="list-style-type: none"> 1. Have dealer replace unit. 2. Tighten all connections. 3. Replace impeller. 4. Remove obstruction. 5. Remove obstruction.

ENGINE

Continued...

Malfunction	Probable Fault	Solution
Engine overheating continued... Engine overheating	<ol style="list-style-type: none">6. Ignition timing late7. Choke valve stuck closed8. Collapsed water pump suction hose9. Loose or worn belts10. Restricted water intake	<ol style="list-style-type: none">6. Have dealer time engine.7. Free choke valve movement.8. Install new hose.9. Adjust or replace as required.10. Clean water intake.
Sludge in oil	<ol style="list-style-type: none">1. Infrequent oil changes2. Dirty oil filter3. Water in oil	<ol style="list-style-type: none">1. Drain and refill with proper grade and viscosity oil.2. Replace filter.3. Drain and refill. If trouble persists, have dealer check engine.

POOR PERFORMANCE

Malfunction	Probable Fault	Solution
Poor performance	<ol style="list-style-type: none">1. Damaged or improper propeller2. Excessive water in bilge area3. Boat overloaded or improper distribution of load4. Fouled or damaged hull bottom	<ol style="list-style-type: none">1. Inspect propeller and replace if required.2. Pump out bilge area. Inspect for causes related to excess water.3. Reduce load or redistribute load.4. Inspect, clean, or repair as required.

VIBRATION

Malfunction	Probable Fault	Solution
Vibration	<ol style="list-style-type: none">1. Loose engine mounting bolts2. Damaged propeller shaft3. Propeller bent or pitch out of true4. Engine out of alignment	<ol style="list-style-type: none">1. Inspect and tighten as required.2. Replace shaft.3. Inspect propeller and replace as required.4. Have dealer correct alignment.

The following information is for your use in caring for the interior and exterior of your boat. If you need more specific information, contact your Rinker dealer.

NOTE: Before attempting to use a particular cleaning solution or method, test the material to be cleaned in a hidden or inconspicuous area for possible adverse reactions. Use cleaning agents sparingly. Never discharge cleaning solutions into the waterways. Do not use products containing phosphates, chlorine, solvents, or nonbiodegradable or petroleum based products.

FIBERGLASS AND GELCOAT

The hull and deck are made of fiberglass. The outer layer of the hull and deck is a color pigmented polyester resin, called gelcoat. Gelcoat is highly resistant to scratches that occur during normal boat use. Some damage to the gelcoat during the life of your boat is bound to occur.

Gelcoat Maintenance

To remove and prevent build-up of most salt, soil, and grime, the hull and deck should be routinely cleaned with household detergent and water.

NOTE: Ensure household detergent **does not** contain ammonia or chlorine. Ammoniate or abrasive type cleaners will dull and discolor the surface of the gelcoat, and are not recommended for use in routine maintenance.

Gelcoat surfaces are very resistant to deep stains. To remove minor stains:

- Wash with a soft cloth and household detergent to remove surface stains. Then rinse thoroughly with clear water.
- If deep stains do occur, use a special fiberglass cleaner and stain remover.

Waxing the gelcoat surface regularly will help prevent soiling and preserve its luster. Rinker

Boat recommends a fiberglass wax that will fill the gelcoat pores. Fiberglass wax contains chemicals that screen out harmful ultraviolet rays that cause fading of the gelcoat color.

⚠ WARNING

WARNING: Never wax deck surfaces that require sure footing. Wet or dry waxed gelcoat is very slippery and hazardous to walk on and/or maintain footing.

Gelcoat Damage Repair

Minor Scratches

Minor scratches can be repaired with automotive rubbing compound or polishing wax. They may not completely disappear, but will not be as noticeable.

- Apply rubbing compound or polishing wax to a damp, soft cloth.
- Rub the gelcoat surface with the damp, soft cloth in a circular motion.

NOTE: Refer to the rubbing compound/polishing wax manufacturer's instructions for detailed information.

Discoloration

The gelcoat surface may discolor if it is not washed and waxed regularly. Discoloration can usually be removed because it is on the gelcoat surface.

- Sand affected areas with 600 grit wet or dry sandpaper. Use plenty of water. **Always sand all areas, including curves, in one direction.**
- After sanding, dry the areas and make sure all discoloration has been removed. If not, repeat the process.
- Buff the sanded surface with a buffing machine having a 1750-2800 rpm capacity to restore the luster.

- Use a soft wool pad and apply a generous amount of a good rubbing compound using a circular motion.
- After buffing, wash off the rubbing compound with clear water. Dry the surface.
- Wax with a high grade fiberglass wax.

Chips, Hairline Cracks, and Small Patches

Purchase gelcoat in the matching color from your Rinker dealer. To match the color properly, specify the boat's model name, color, and year manufactured.

When patching your boat, keep the room temperature at 65° F minimum.

- Area to be repaired must be free of any dirt, water, oil or wax. Wash and dry the damaged area thoroughly before beginning.
- Sand the area with #50 sandpaper or use a power drill with a burr bit. Round out and feather edge the surrounding areas. Remove all flaky edges. If the surface cracks cover a large area, use the power sander to smooth the rough edges.
- Cleanse the area with rubbing alcohol or acetone after you have completed sanding.

▲ WARNING

WARNING: Acetone is a hazardous material and should be used only in well ventilated areas. Follow the manufacturer's instructions. Never store rags diluted with acetone or any other solvent aboard your boat. Discard them immediately to prevent spontaneous combustion and fire.

- On a piece of wood or cardboard, place one teaspoon of the gelcoat.
- Add two to three drops of hardener. Mix for 10 to 15 seconds using a spatula or knife.
- Apply gelcoat to the area. Fill the area a little higher than the surrounding surface.
- Cover with wax paper or clear plastic and smooth to the desired contour.

- Let the area dry. This usually takes between one to two hours.
- Remove the wax paper or plastic. Then water sand with #600 wet or dry sandpaper.
- Buff the area with buffing compound. Follow this with wax and polish.

▲ WARNING

WARNING: If using an electric buffer, be very careful not to pause in one area too long. This will cause overheating of the gelcoat and may cut into the boat's surface.

Hull Bottom Maintenance

NOTE: If your boat will be in water continuously for periods longer than two weeks, Rinker Boat recommends sealing the hull bottom with a high quality barrier coating. Failure to do so could result in the formation of "water blisters". Repair of water blister damage is not covered under the Rinker Boat Warranty. Several manufacturers have products on the market that can be used to help prevent water blisters. Contact your Rinker dealer to purchase or obtain information about barrier coating products.

Wire brushes, scouring pads, or other abrasive type materials/solutions **should never** be used on the bottom surface of your boat. They create small scratch marks that will collect dirt, silt, sand, marine growth and other foreign materials.

Keep the hull bottom of your boat clean and make a practice of inspecting for any signs of excessive wear or damage. Needed repairs to the hull bottom should be performed immediately. Accumulation of natural coatings from water and marine growth can potentially create drag and limit the efficiency of your boat.

Bottom Paint (Antifouling)

The antifouling bottom paint is designed to dissolve slowly to prevent marine growth. Thus, the boat bottom will usually require

painting after the boating season. Some variables to consider when selecting a protective bottom paint are the water temperature, pollution, salinity, current, and organic matter contained within the water. To protect and repaint the boat bottom, perform the following:

IMPORTANT: Consult your Rinker dealer for recommended bottom paints and local laws that govern your area. Many states regulate the chemical content of bottom paints to meet environmental standards and regulations.

- Annually remove boat from water; then scrub bottom with a bristled brush and solution of soap and water.

NOTE: Repainting the bottom is not mandatory each time the bottom is scrubbed, providing there are no bare areas visible in the bottom paint.

- Sand entire bottom surface of the boat.
- Fair (smooth-out) all rough areas as required.
- Clean bottom surface to remove all dust and foreign materials.
- Ensure bottom surface is completely dry.
- Apply new coat of bottom paint.

NOTE: Allow for a 24 to 36 hour drying period of new bottom paint before launching your boat. Never attempt to haul, paint and launch on the same day.

DECK HARDWARE AND FITTINGS

Inspection

Inspect the hardware and fittings to ensure proper tightness. All screws, bolts, clamps, cleats, etc., should all be secure. Never use cleats or bow or stern eyes to lift the boat.

Cleaning and Care

- **Always** clean stainless steel frequently with soap and water. Any cleaner safe for glass is usually safe for stainless steel.

- **Always** remove rust spots as soon as possible with a brass, silver, or chrome cleaner. Irreversible pitting will develop under rust that remains on stainless steel for any period of time.
- **Always** use a cleaner, like a good car wax, for added beauty and protection.
- **Never** use coarse abrasives like **sandpaper or steel wool** on stainless steel. These may actually cause rusting.
- **Never** clean with mineral acids or bleaches.
- **Never** leave stainless steel in contact with iron, steel, or other metals which cause contamination leading to rust or corrosion.

WINDSHIELD AND PORTALS

Cleaning Glass

The helm windshield is made of tempered safety glass. Safety glass will shatter into small pieces upon impact and is affected by temperature changes.

- Clean glass with glass cleaner or ammonia water, then rinse with plenty of clear water.
- Remove grease and/or oil with kerosene or hexane.

CAUTION

CAUTION: Never use acetone, benzine, carbon tetrachloride, lacquer thinner, or similar type solvents. They penetrate the glass surface and cause hazing that will obstruct visibility.

Cleaning Plexiglass and Vinyl

CAUTION

CAUTION: Never use acetone, benzine, carbon tetrachloride, lacquer thinner, or similar type solvents. They penetrate the surface and cause hazing that will obstruct visibility.

The canvas or weather covering windows are made of a synthetic material. Wash all Plexiglass, clear vinyl or other synthetic materials with a mild detergent or dish washing liquid and water solution, then rinse with plenty of clear water. Remove grease and/or oil with kerosene or hexane.

CARPET

Cleaning

- Clean the indoor/outdoor carpet with a scrub brush, mild detergent or dish washing liquid and warm water solution.
- After cleaning, thoroughly rinse the indoor/outdoor carpet with clear water.

Care

- After using the boat, allow carpet to dry completely in the sun to prevent mildew.
- Apply a light coating of Scotch Guard® to protect against accidental spills.

SEAT COVERINGS AND VINYL

The seat coverings and trim are made of expandable vinyl. Extreme temperatures have little effect on them due to their expandable composition.

Cleaning

- Remove stains when possible, to eliminate any possible reaction between staining agent and vinyl fabric.
- Many sunscreens and tanning aids contain chemicals that may stain seat coverings. Vinyls should be cleaned immediately after contact with these products. Stains of this type are not covered under warranty.
- Wipe most dirt and smudges with mild soap and warm water. If additional cleaning is required, scrub with a soft bristle brush to remove dirt from textured patterns. Dry with a soft, lint-free cloth or towel. Do not use 409 Cleaner®.

- For more difficult stains, use a stronger detergent following the manufacturer's instructions closely.
- Never use steel wool or powdered abrasive cleaners. They will mar the surface and leave an unsightly appearance.

Care

- Apply a vinyl protectorant to keep the seats clean and pliable. Do not use silicone based products.
- Place removable exterior cushions inside the boat when not in use.
- To store cushions on board boat for winter or extended periods of time:
 - A. Open zippers and elevate cover away from foam padding.
 - B. Place a small rounded object (ie., plastic bowl) inside to allow for air circulation.
 - C. Seats that can be folded should be stored in the down position.
 - D. Use plastic seat covers. They will keep out dampness and protect against mildew.

CANVAS (WEATHER COVERINGS)

Your Rinker boat is fundamentally an open vehicle. Therefore, in spite of well-designed and well-fitting canvas enclosures, your boat is NOT water proof in the same sense that your automobile is waterproof. In spite of the best efforts to design these enclosures to conform with the boat, a certain amount of leakage may transpire. The construction of the canvas tops and curtains involves sewing as the primary choices of fastening. The needle results in holes at the seam lines which can admit water. Needle holes elongate with time and usage. After cleaning with soap and water, allow seams to thoroughly dry. A vinyl daub sealant can be applied on the seams to somewhat close the needle holes. This sealant must be applied with the canvas up and stretched tight. Your canvas-system is not

warranted to provide a water-tight enclosure. The canvas top supplied with your boat is not a storage cover. Canvas tops which has been used as a storage cover will not be covered by the manufacturer's warranty.

The canvas, or weather coverings, are manufactured from materials that are resistant to water, mildew, rot and weather.

Cleaning

- Wet down all canvas material. Then, use a soft bristle brush to scrub with a mild detergent or dish washing liquid and water solution.
- If heavy build-up of soil or mildew occurs, apply a mild solution of ammonia and water and scrub. Follow scrubbing with a thorough rinsing.
- Brush or sweep the underside of the top. Spray with Lysol™ or other disinfectant to prevent mildew.

Care

- Rinker Boat strongly recommends the use of a storage cover when the boat is not in use. The use of a cruising canvas as a storage cover is not recommended.
- Lubricate the zippers with paraffin, and the snaps with petroleum jelly.
- If a leak occurs along a canvas seam, rub with a vinyl daub sealant, or apply Scotch Guard® treatment.
- Air dry all canvas material before storing. **Never** store canvas damp or wet, and provide proper ventilation to limit the possibility of mildew. If clear plastic canvas parts are stored wet, permanent clouding of the clear plastic may result.
- Avoid mooring under trees.
- Do not tow your boat with the top in the raised position as this may cause damage not covered under warranty.

Acrylic fabrics should be cleaned regularly before dirt and other particles accumulate and become embedded.

- Brush off dirt and particles and clean with natural soap (not detergent) in lukewarm water. Rinse thoroughly with cold water to remove soap.
- Treat stubborn stains with a solution of 1/2 cup non-chlorine bleach and 1/4 cup natural soap per gallon of lukewarm water. Rinse thoroughly with cold water to remove soap.

NOTE: Excessive soaking can deteriorate sewing threads. This treatment may remove part of the fabric's water repellancy.

CABIN CUSHIONS, SIDE CURTAINS AND FABRICS

- Clean interior cabin cushions with a foam type cleaner. Follow all instructions as recommended by the product manufacturer.
- All side curtains and fabrics, other than vinyl, should be dry cleaned.

The information provided here is for winterizing and storing your Rinker boat after the boating season. In regions where temperatures fall below freezing, **all engine plugs must be removed before storing your boat for the winter.** Failure to do so will seriously damage the engine. Rinker Boat strongly recommends that a competent marine dealer winterize your boat. If your location does not require winter storage, we recommend an annual inspection. With proper care your Rinker boat will provide you many years of enjoyable boating.

DRY STORAGE PREPARATION

NOTE: Refer to Chapter 7, Interior and Exterior Care for specific cleaning solutions and procedures.

Deck

- Wash deck and walk-way surfaces.
- Clean all deck hardware; then apply one coat of rust inhibitor.
- Clean the indoor/outdoor carpet.

Hull

- Scrape off any barnacles or crusted marine growth.
- Scrub hull thoroughly to remove marine growth, scum and loose paint.
- Inspect underwater gear and propeller for excessive wear or damage.
- Apply fresh coat of bottom paint.
- Remove hull drain plug; then store plug in a safe place.

General Housekeeping

- Scrub inside boat including all cupboards, cabinets and drawers.
- Remove all cushions, mattresses, curtains, blankets and sheets, pillows, towels

and linens, clothing and any other items that can hold moisture and cause mildew.

NOTE: Mattresses and cushions can be left on board only if they can be propped up where air can circulate.

- The cabin should be well ventilated.
- Life jackets and other safety equipment left on board must have adequate air circulation.
- Clean and dry bilge. Remove any materials such as rags, sponges, or other cleaning material.
- Weather permitting, open all doors, hatches, portals, and windows to air out the interior for a day or two.
- If covering boat while in storage, use a cover constructed of fabric that allows for plenty of ventilation.

ENGINE

Cooling System

Drain cooling system when storing boat for extended periods of time, or when freezing temperatures are possible. This will prevent corrosion damage.

IMPORTANT: When placing boat in dry storage, position boat so that engine is level.

- When draining cooling system, ensure that plug openings are free of foreign materials (i.e., sand, silt, marine growth, rust etc.).
- Further protection against rust and freezing can be provided by filling cooling system with anti-freeze and fresh water.
- Mix anti-freeze, as instructed by anti-freeze manufacturer, in recommended proportion for lowest temperature that engine will be exposed.

- Refer to Engine Owner's manual for detailed winterizing and storage instructions.

Lubrication

- Drain crankcase only after engine has reached operating temperature. This will ensure complete drainage of oil.

NOTE: If the drained engine oil contains sludge, engine should be flushed with flushing oil. Refer to engine owner's manual for detailed winterizing and storage instructions.

- Replace engine oil filter.
- Fill crankcase with required quantity of recommended engine oil. Refer to engine owner's manual.
- Shut off fuel line and start engine.
- Pour or spray fogging oil through carburetor air intake. Continue to pour or spray fogging oil until engine stops.

NOTE: Engine will stop due to lack of gasoline supplied from shut off fuel line.

- Clean and lubricate all linkage.
- Spray entire exterior of engine with rust and corrosion inhibitor.
- Remove stern drive unit.
- Have engine alignment checked and adjusted as required by a qualified technician.
- Inspect all gaskets and seals, grease the U-joints, and change gear oil.
- Install new gaskets and seals, and reinstall stern drive unit.
- Remove propeller. Clean and lubricate the prop shaft. Repair if necessary.

FUEL SYSTEM

Add a gasoline stabilizer solution to the fuel tank. Follow the product manufacturer's recommended procedure.

BATTERY

- Remove battery from boat and store away from freezing temperatures.

NOTE: Battery should be stored in a cool dry place on a wooden pallet. Avoid direct placement on concrete, brick, or dirt floors as the charge will be absorbed into the ground.

⚠ WARNING

WARNING: Battery electrolyte can cause severe eye damage and burns to the skin. Wear goggles, rubber gloves and a protective apron when working with battery. If spillage occurs, wash area with a solution of baking soda and water.

- Clean outside battery case, terminals, and battery clamps with a baking soda and water solution.

NOTE: Do not allow baking soda and water solution to enter the cells.

- Clean battery posts and clamps with a piece of fine grit emery cloth. Use a light sanding motion when cleaning.
- Apply a light coat of petroleum jelly to cover end of battery cables.
- A monthly recharge or continuous trickle charge should be applied to the battery during storage.

RECOMMISSIONING

- Inspect visually and by smelling the fuel system and all associated components for proper connections, wear, leaks, or other damage and needed repair.

NOTE: For detailed information on recommissioning your boat's systems and equipment, refer to the product manufacturer's owner/service manual.

IMPORTANT: Rinker Boat cannot overemphasize our concern for your safety. Inspection of the fuel system is a most important safety precaution.

- Clean battery terminal posts with wire brush or steel wool before reinstallation.
- Check charge on battery. Recharge or replace if necessary.
- Inspect all battery wiring. Repair or replace if necessary.
- Attach battery cables, then tighten cable clamps.
- Apply petroleum jelly or marine grade grease on battery posts and clamps. This will eliminate possible build-ups of air pockets and acid.

IMPORTANT: Do not apply petroleum jelly or marine grade grease before connecting and tightening clamps.

- Reinstall the hull drain plug after coating threads with petroleum jelly.
- Clean the bilge area.
- Reinstall the exhaust drain plug.
- Inspect all exhaust connections to avoid exhaust and carbon monoxide (CO) leakage. Tighten any loose clamps.
- Test operation of navigational lights and other lighting on board. Repair or replace if necessary.
- Inspect all wiring for fraying, wear, loose connections, or other damage. Repair or replace if necessary.
- Inspect all switches, controls, and other related equipment for proper operation. Repair or replace if necessary.
- Inspect all life jackets (PFDs), anchor lines, and other safety related equipment for proper operation and physical condition. Repair or replace if necessary. By law, damaged PFDs must be replaced.

Abaft

Toward the stern.

Abeam

Amidships, at a right angle to the keel.

Aboard

On, in, or into a boat.

ABYC

American Boat and Yacht Council, Inc., the organization that sets voluntary safety and construction standards for small craft in the USA.

Adrift

Without motive power and without anchor or mooring.

Afloat

On the water.

Aft

Describing the after section of a vessel, or things to the rear of amidships and near the stern.

Aground

Touching bottom.

Amidships

In the center, the center portion of a vessel.

Anchor

A forging or casting shaped to grip the sea bottom and, by means of a cable or rope, hold a boat in a desired position.

Anchorage

A customary, suitable and (usually) designated harbor area in which vessels may anchor.

Astern

Toward the stern. An object that is aft of a boat is said to be astern of the boat.

Athwart

Across.

Aweigh

Off the bottom, said of an anchor.

Aye

Yes, while aboard a boat or ship. Means "I understand."

Ball (Bale)

To remove water from a boat by pump or bailer.

Ballast

Heavy material such as iron, lead, or stone placed in the bottom of the vessel.

Beacon

A post or buoy placed over a shoal or bank to warn vessels, also a signal mark on land.

Beam

Imaginary line amidships at right angles to keel of vessel. Also vessel's width amidships.

Bearing

The direction or point of the compass in which an object is seen.

Belay

To make fast to a cleat or belaying pin; to cancel an order.

Below

Beneath, or under, the deck. One goes below when going down into the cabin.

Bend

To fasten by means of a bend or knot.

Berth

A position, as a place to sleep or in which a vessel maybe made fast; a margin of safety, as "a wide berth."

Bilge

The lower internal part of a boat's hull.

Bollard

A strong post for holding lines fast.

Bow

The forward part or front of the boat.

Breakers

Waves cresting as they reach shallow water, as at or on a beach.

Breakwater

A structure, usually stone or concrete, built to create a harbor or improve an existing one.

Bulkhead

Vertical partition in a boat.

Burdened Vessel

Former term for the vessel which must stay clear of vessels with the right-of-way.

Calking (Caulking)

Forcing filler material into the seams of the planks in a boat's deck or sides, to make them watertight.

Camber

The arch of a deck, sloping downward from the center toward the sides.

Capsize

To turn over.

Carburetor

Backfire Flame Arrestor Required equipment on all motorboats except outboards and diesels. Reduces chance of fire caused by backfires in internal combustion engines.

Cardinal Points

The four main points of a compass; north, east, south, and west.

Ceiling

The inside lining of the hull.

Certificate

Government paper, such as a boat's license.

Chart

A map of a body of water that contains piloting information.

Chine

The intersection of sides and bottom of a boat.

Cleat

A piece of wood or metal with projecting ends to which lines are made fast.

Clinker

A method of planking in which the lower edge of each strake overlaps the upper edge of the strake next below. (Also called lapstrake.)

Coaming

A raised edge, as around part or all of a cockpit, that prevents seawater from entering the boat.

Coast Guard

The federal marine law enforcement and rescue agency in the US.

Cockpit

A well or sunken space in the afterdeck of a small boat for the use of the helmsman and crew.

Companionway

A hatch or entrance, from deck to cabin.

Compass

The instrument which shows the heading of a vessel.

Cowls

Hooded openings used for ventilation.

Cradle

A frame used to support a vessel on land.

Current

The movement of the water in a horizontal direction.

Deadrise

The rise of the bottom of a midships frame from the keel to the bilge.

Deck

Any permanent covering over a compartment.

Deep-six

To discard or throw overboard.

Depth Sounder

An electronic depth-finding instrument, measuring the time a sound wave takes to go from the vessel to the bottom and return, then displaying the result in feet, fathoms, or meters.

Dinghy

A small, open boat.

Displacement Hull

Type of hull that plows through the water even when more power is added.

Dock

An enclosed or nearly enclosed water area; all the port installations; a place where vessels can moor, as a pier, wharf, or floating dock.

Documented Vessel

Vessel registered with the U.S. Coast Guard.

Dolphin

A small group of piles, in the water, generally used for mooring or as a channel marker.

Draft

The depth of the vessel below the water line, measured vertically to the lowest part of the hull.

Dunnage

Mats, boughs, pieces of wood, or other loose materials placed under or among goods carried as cargo in the hold of a ship to keep them dry and to prevent their motion and chafing; cushioning or padding used in a shipping container to protect fragile articles against shock and breakage; baggage or personal effects.

Ebb

An outgoing tide.

Estuary

An inlet or arm of the sea.

Fathom

Six feet.

Fenders

Objects placed along the side of the boat to protect the hull from damage.

Flare

The outward spread of the boat's sides from the waterline to the rail at the bow. Also, a pyrotechnic signalling device that can indicate distress.

Fore

Used to distinguish the forward part of a boat or things forward of amidships. It is the opposite of aft or after.

Forward

Toward the bow.

Frame

Ribs of the hull, extending from the keel to the highest continuous deck.

Freeboard

The vertical distance measured on a boat's side from the waterline to the gunwale.

Galley

The kitchen area of a boat.

Gimbals

Swivels used to keep equipment level.

Give-Way Vessel

The one which must stay clear of vessels which have the right-of-way.

Grab Rail

A convenient grip, on a cabin top or along a companion ladder.

Gunwale (pronounced gunnel)

The upper edge of a boat's side.

Harbor

A safe anchorage, protected from most storms; may be natural or man-made, with breakwaters and jetties; a place for docking and loading.

Hatch

An opening in a boat's deck for persons or cargo to go below.

Head

A marine toilet.

Headway

Forward motion of a vessel through the water.

Helm

The wheel or tiller by which a ship is steered.

Holding Tank

Storage tank for sewage, so that it will not be pumped overboard into the water.

Hull

The body of a boat.

Hypothermia

A physical condition where the body loses heat faster than it can produce it.

Inboard

More toward the center of a vessel; inside; a motor fitted inside the boat.

Inland Rules

Rules of the road that apply to vessel operation in harbors and certain rivers, lakes, and inland waterways.

Intracoastal Waterways

ICW: bays, rivers and canals along the coasts (such as Atlantic and Gulf of Mexico coasts), connected so that vessels may travel without going into the open sea.

Jetty

A structure, usually masonry, projecting out from the shore; a jetty may protect a harbor entrance.

Keel

The permanently positioned, fore-and-aft backbone member of a boat's hull.

Knot

To bend a line. Also, a unit of speed equal to one nautical mile (6,076.10 feet) an hour.

Launch

- (1) To put a vessel into the water;
- (2) A small open powerboat, mainly used for transportation between a vessel and shore.

Lee

The side opposite to that from which the wind blows.

Leeward

Situated on the side turned away from the wind. (Opposite of windward.)

Leeway

The amount a boat is carried sideways by the wind's force or current.

Limber Holes

Drainage holes in the bilge timbers of a vessel, allowing to run to a low point for pumping out.

List

- (1) A continuous leaning to one side; often caused by an imbalance in stowage or a leak into one compartment;
- (2) A light list is a printed listing of aids to navigation, in geographical order or inclining of a vessel toward the side.

LOA

Length over all; the maximum length of a vessel's hull, excluding projecting spars or rudder.

Locker

A storage place, a closet.

Log

A record or diary of a vessel's journey.

Lubber's Line

A mark or permanent line on a compass that shows the course of the boat.

Making Way

Making progress through the water.

Marina

A place, essentially a dock area, where small recreational craft are kept; usually floats or piers, as well as service facilities, are available.

MAYDAY

A radio distress call, from the french m'aidez (help me); SOS in Morse Code.

Mooring

Commonly, the anchor chain, buoy, pennant, etc., by which a boat is permanently anchored in one location.

Motor

A source of mechanical power.

Motorboat

Any watercraft 65 feet or less in length propelled by machinery, whether or not such machinery is the principal source of propulsion.

Navigation

The art of conducting a ship from port to port.

Nautical Mile

6076.12 feet, or 1852 meters, an international standard; the geographical mile, the length of one minute of latitude at the equator, is 6087.20 feet.

Nun Buoy

A conical, red buoy bearing an even number and marking the starboard side of a channel from seaward.

Oar

A long, wooden instrument with a flat blade at one end, used for propelling a boat.

Outboard

- (1) A propulsion unit for boats, attached at the transom; includes motor, drive-shaft, and propeller; fuel tank and battery may be integral or installed separately in the boat;
- (2) Outside or away from a vessel's hull; opposite of inboard.

Outdrive

A propulsion system for boats, with an inboard motor operating an exterior drive, with driveshaft, gears, and propeller; also called stern-drive and inboard/outboard.

Overall Length

The extreme length of a vessel, excluding spars or rigging fittings. See LOA.

Painter

A rope attached to the bow of a boat for making it fast.

PFD

Personal Flotation Device.

Pier

A structure, usually wood or masonry, extending into the water, used as a landing place for boats and ships.

Pile

A vertical wooden or concrete pole, driven into the bottom; may be a support for a pier or floats; also used for mooring.

Piling

A structure of piles.

Pitch

- (1) The up and down movement as the bow and stern rise and fall due to wave action;
- (2) The theoretical distance advanced by a propeller in one revolution.

Planning Hull

Type of hull that is shaped to lift out of the water at high speed and ride on the surface.

Port

The left side of a boat when you are facing the bow, also a destination or harbor.

Privileged Vessel

Former term for the vessel with the right-of-way.

Propeller

Wheel or screw. Mechanism that pushes water aft to propel the boat.

Rigging

The general term for all lines(ropes) of a vessel.

Roll

The sideward motion of a boat caused by wind or waves.

Rules of the Road

The nautical traffic rules for preventing collisions on the water.

Scope

The length of the anchor rope or chain. 6 to 1 scope means that the length of the anchor rope from the boat to the anchor is 6 times the depth of the water.

Scupper

A hole allowing water to run off the deck.

Sea Anchor

A floating canvas cone, held open by wire rings, with an opening in the smaller end, and a rope bridle at the larger end attached to a line leading to the vessel; used in storm conditions to (a) keep the bow of the boat to the wind, and (b) slow downwind drift of the boat.

Sea Cock

A through-hull valve, a shut-off on a plumbing or drain pipe between the vessel's interior and the sea.

Slip

- (1) A berth for a boat between two piers or floats;
- (2) The percentage difference between the theoretical and the actual distance that a propeller advances when turning in water under load.

Sole

The cabin or cockpit floor.

Spar Buoy

A channel marker that looks like a tall, slender pole.

Stand-On Vessel

The vessel with the right-of-way.

Starboard

The right side of a boat when you are facing the bow.

Stern

The after end or back of the boat.

Stow

To store items neatly and securely.

Strake

Planks running fore and aft on the outside of a vessel.

Taffrail

The rail around a boat's stern.

Tide

The alternate rise and fall of waters caused by the gravitational attraction of moon or sun.

Topsides

- (1) The sides of a vessel above the waterline;
- (2) On deck as opposed to below deck.

Transom

The transverse planking which forms the afterend of a small, square-ended boat. (Outboard motors are usually attached to a transom.)

Trim

To arrange weights in a vessel in such a manner as to obtain desired draft at bow and stern.

Trimaran

Boat with three hulls, the center one is the largest.

Unbend

To cast-off or untie.

Underway

Vessel in motion, i.e., when not moored, at anchor or aground.

USPS

United States Power Squadron, a private membership organization that specializes in boating education and good boating practices.

Vessel

Every kind of watercraft, other than a sea-plane on the water, capable of being used as a means of transportation on water.

VHF Radio

A Very High Frequency electronic communications and direction finding system.

Wake

Moving waves, created by vessel motion. Track or path that a boat leaves behind it, when moving across the water.

Wash

The loose or broken water left behind a vessel as it moves along; the surging action of waves.

Waterline

The intersection of a vessel's hull and the water's surface; the line separating the bottom paint and the topsides.

Way

Movement of a vessel through the water. Technically it is underway when not at anchor, aground, or made fast to the shore. The common usage is interpreted as progress through the water. Headway when going forward and Sternway when it is going backwards.

Well

Area at the rear of a boat where the motor may be located.

Wharf

A structure, parallel to the shore, for docking vessels.

Wheel

- (1) The steering wheel;
- (2) The propeller.

Whistle Signal

A standard communication signal between boats, to indicate change of course, danger, or other situations.

Windward

Situated on the side closest to the wind. (Opposite of leeward.)

Yaw

To swing or steer off course, as when running with a quartering sea.



Rinker Boat Company, Inc.
300 W. Chicago Street
Syracuse, IN 46567