



SUPER SPORT
OWNER'S MANUAL

218SS, 238SS, 258SS,
278SC, 278SS, 298SS, 328SS



Dear Valued Customer,

Welcome to the Monterey Life!

We would like to extend to you our "Thank You" for choosing a Monterey boat!

You have made an investment in our product and we are confident you will enjoy many years of boating pleasure. Your new boat has been built to the standards set forth by the United States Coast Guard and National Marine Manufacturers Association. We are proud to have you in our "Family!"

At this time, we need you to read your owner's manual and become familiar with all systems on your boat. Make certain that you and your dealer have filled out and mailed your warranty registration card back to us here at the factory. It is very important to us and it is also a U.S. Federal Regulation.

This manual is an important aid in the operation and maintenance of your boat. The information is intended as a guide and cannot cover every question you may have about your boat and boating in general. We encourage you to contact your dealership for any additional information you might need. If there is a question about your boat that can't be answered by your dealer, please contact our factory direct by calling the Monterey Boats Customer Service Department, (352) 529-9181 or online if you prefer at: www.info@montereyboats.com.

If you are new to boating, we recommend you participate in a boating class or group to gain more knowledge and confidence. Contact your dealer, local U.S. Coast Guard or U.S. Power Squadron Organizations for information in your area.

With proper care, routine service and preventive maintenance, your Monterey boat will not only reward you with enjoyment, but with reliability, dependability and one of the higher resale values in today's boating industry.

Enjoy your new boat and please respect our environment at all times. Always remember to practice safe boating procedures for your protection as well as those around you.

Sincerely,

The M.O.S.T. (Monterey Owners Support Team)

THIS PAGE WAS LEFT BLANK
INTENTIONALLY

WELCOME	3
SAFETY INFORMATION	9
BOAT INFORMATION	11
CERTIFICATIONS	12
INTRODUCTION & IMPORTANT INFORMATION	13
OWNER/OPERATOR INFORMATION	15
NEW BOAT DELIVERY	16

Chapter 1: SAFETY EQUIPMENT

1.1 General	17
1.2 Engine Alarm.....	17
1.3 Neutral Safety Switch	17
1.4 Engine Stop Switch	18
1.5 Required Safety Equipment	18
1.6 Bilge and Fuel Fires	19
1.7 Fire Port	20
1.8 Automatic Fire Extinguishing System (Optional)	20
1.9 Carbon Monoxide Poisoning	21
1.10 First Aid	22
1.11 Additional Safety Equipment	22
1.12 Caution & Warning Labels	23

Chapter 2: OPERATION

2.1 General	25
2.2 Rules of the Road	25
2.3 Pre-Cruise Check	28
2.4 Operating Your Boat	29
2.5 Single Engine Docking, Anchoring & Mooring	30
2.6 Twin Engine Docking, Anchoring & Mooring	32
2.7 Controls, Steering or Propulsion System Failure.....	34
2.8 Collision.....	34
2.9 Grounding, Towing & Rendering Assistance.....	34
2.10 Flooding or Capsizing.....	35
2.11 Fishing.....	35
2.12 Water Skiing & Wakeboarding	35
2.13 Wake/Teak Surfing	37
2.14 Man Overboard	37
2.15 Trash Disposal	38
2.16 Maximum Capacities Plate	39
2.17 Trailering Your Boat	40

Chapter 3: PROPULSION SYSTEM

3.1 General	43
3.2 Drive Systems	43
3.3 Engine Exhaust System.....	44
3.4 Engine Cooling System	45
3.5 Propellers	45
3.6 Performance Issues and Propellers.....	46
3.7 Helm and Engine Instrumentation	47

Chapter 4:

HELM CONTROL SYSTEMS

4.1 General	51
4.2 Engine Throttle and Shift Controls	51
4.3 Engine Stop Switch	54
4.4 Neutral Safety Switch	54
4.5 Outdrive Power Tilt and Trim.....	55
4.6 Steering System	56
4.7 Joystick Controls.....	57
4.8 Trim Tabs.....	58
4.9 Control Systems Maintenance	59

Chapter 5:

FUEL SYSTEM

5.1 General	61
5.2 Engine Fuel Delivery System.....	63
5.3 Generator Fuel System	63
5.4 Fueling Instructions.....	64
5.5 Fuel System Maintenance.....	66

Chapter 6:

ELECTRICAL SYSTEM

6.1 General	67
6.2 Single Engine Battery Systems.....	67
6.3 Twin Engine Battery System	70
6.4 12 volt Accessory Switch Panels	72
6.5 Circuit Breaker Panels (214SS/218SS/234SS/238SS/268SS)	77
6.6 Circuit Breaker Panels (288SS/328SS)	79
6.7 AC Battery Charging System (Single Engine Boats).....	86
6.8 Battery Charger	87
6.9 DC To AC Power Inverter (328SS)	87
6.10 120 Volt AC System (328SS)	88
6.11 Generator.....	92
6.12 Bonding System.....	94
6.13 Electrical System Maintenance	94
6.14 AC Line Load Estimator	96

Chapter 7:

FRESH WATER SYSTEM

7.1 General	97
7.2 Fresh Water System Operation.....	97
7.3 Water Heater (328SS)	97
7.4 Shore Water Connection (328SS)	98
7.5 Shower Operation	98
7.6 Fresh Water System Maintenance.....	99

Chapter 7:

RAW WATER SYSTEM

8.1 General	101
8.2 Air Conditioning (328SS).....	101
8.3 Raw Water System Maintenance.....	102

Chapter 9:

DRAINAGE SYSTEMS

9.1 General	103
9.2 Bilge Drainage	103
9.3 Cockpit and Deck Drains	105
9.4 Cabin and Head Compartment Drains (328SS)	106
9.5 Head Compartment Drains (268SS/288SS).....	106
9.6 Grey Water System (268SS/288SS/328SS)	106
9.7 Drainage System Maintenance	107

Chapter 10:

VENTILATION SYSTEM

10.1 Cabin & Head Compartment Ventilation (268SS/288SS/328SS).....	109
10.2 Carbon Monoxide & Proper Ventilation	111
10.3 Engine Compartment Ventilation	112
10.4 Maintenance	113

Chapter 11:

EXTERIOR EQUIPMENT

11.1 Deck Equipment.....	115
11.2 Windlass & Bow Roller (268SS/288SS/328SS).....	118
11.3 Hull Equipment	119
11.4 Cockpit Equipment - All Models	122
11.5 Cockpit Features (214SS/218SS/234SS/238SS)	125
11.6 Cockpit Equipment (268SS/288SS).....	130
11.7 Cockpit Features (328SS).....	142
11.8 Bimini Top & Optional Canvas	152
11.9 Radar Arch	152
11.10 Aftermarket Arch	157

Chapter 12:

INTERIOR EQUIPMENT

12.1 Head Compartment	159
12.2 Marine Head Systems	160
10.3 Cabin (328SS)	163
10.4 Air Conditioner (328SS)	165

Chapter 13:

ROUTINE MAINTENANCE

13.1 Exterior Hull and Deck	167
13.2 Upholstery, Canvas and Enclosures	172
13.3 Cabin Interior	177
13.4 Bilge and Engine Compartment	178
13.5 Drainage System.....	179

Chapter 14:

SEASONAL MAINTENANCE

14.1 Lay-up and Storage	181
14.2 Winterizing.....	183
14.3 Recommissioning	185

Appendix A	
Maintenance Log	187
Appendix B:	
Float Plan	191
Appendix C:	
Boating Accident Report	193
Appendix D:	
Glossary of Terms.....	197
Appendix E:	
Troubleshooting Guide.....	203
Appendix F:	
Medallion Gauges Quick Reference Guide	209
Appendix G:	
Wiring Diagrams.....	217
214/218 Super Sport.....	218
234/238 Super Sport.....	223
268 Super Sport	228
288 Super Sport	236
328 Super Sport	241
Appendix H:	
Occupant Seating	263
Appendix I:	
Specifications.....	265
214/218 Super Sport.....	265
234/238 Super Sport.....	266
268 Super Sport	267
288 Super Sport	268
328 Super Sport	269
Appendix J:	
Monterey Boats Lifetime Limited Warranty	271

Safety Cautions and Warnings

Your Monterey owner's manual has been written to include a number of safety instructions to assure the safe operation and maintenance of your boat. These instructions are in the form of **DANGER**, **WARNING**, and **CAUTION** statements. The following definitions apply:

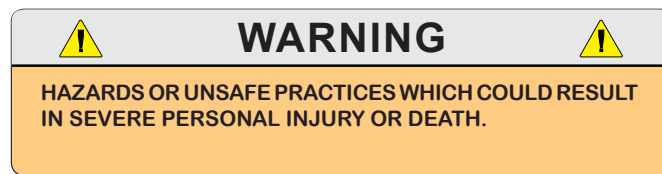

All instructions given in this book are as seen from the stern looking toward the bow, with starboard being to your right, and port to your left. A glossary of boating terms is included.

IMPORTANT NOTE: Your boat uses an internal combustion engine and flammable fuel. Every precaution has been taken by Monterey to reduce the risks associated with possible injury and damage from fire or explosion, but your own precaution and good maintenance procedures are necessary in order to enjoy safe operation of your boat.

State of California Safety Requirements



WARNING



PROPOSITION 65

A WIDE VARIETY OF COMPONENTS USED ON THIS VESSEL CONTAIN OR EMIT CHEMICALS KNOWN TO THE STATE OF CALIFORNIA TO CAUSE CANCER AND BIRTH DEFECTS AND OTHER REPRODUCTIVE HARM.

EXAMPLES INCLUDE:

- ENGINE AND GENERATOR EXHAUST.
- ENGINE AND GENERATOR FUEL, AND OTHER LIQUIDS SUCH AS COOLANTS AND OIL, ESPECIALLY USED MOTOR OIL.
- COOKING FUELS.
- CLEANERS, PAINTS, AND SUBSTANCES USED FOR VESSEL REPAIR.
- WASTE MATERIALS THAT RESULT FROM WEAR OF VESSEL COMPONENTS.
- LEAD FROM BATTERY TERMINALS AND FROM OTHER SOURCES SUCH AS BALLAST OR FISHING SINKERS.

TO AVOID HARM:

- KEEP AWAY FROM ENGINE, GENERATOR, AND COOKING FUEL EXHAUST FUMES.
- WASH AREAS THOROUGHLY WITH SOAP AND WATER AFTER HANDLING THE SUBSTANCES ABOVE.

California Health & Safety Code §§ 25249.5-.13

State of California Emission Requirements

Your boat may be equipped with an engine that meets the special requirements outlined by the California Air Resources Board (CARB). If so, the engine is designed to meet strict requirements and the boat will have a special tag and one of the following labels affixed to it.

The tag and the label are required by CARB. The label has 1, 2, 3 or 4 stars and must be affixed to your boat if it is to be operated in the state of California and/or bordering waters. For more information visit: <http://www.arb.ca.gov>.



Please fill out the following information section and leave it in your Monterey owner's manual. This information will be important for you and Monterey service personnel to know, if you may need to call them for technical assistance or service.

BOAT			
MODEL:	HULL SERIAL #:		
PURCHASE DATE:	DELIVERY DATE:		
IGNITION KEYS #:	REGISTRATION #:		
DOOR KEY #:	OTHER KEYS #:		
ENGINES			
MAKE:	MODEL:		
PORT SERIAL #:	STARBOARD SERIAL #:		
OUTDRIVES			
MAKE:	MODEL:		
PORT SERIAL #:	STARBOARD SERIAL #:		
RATIO:			
GENERATOR			
MAKE:	MODEL:		
SERIAL #:	KILOWATTS:		
PROPELLERS			
MAKE:	BLADES:		
DIAMETER/PITCH:	SHAFT:		
AIR CONDITIONER			
MAKE:	MODEL:		
SERIAL #:	BTU OUTPUT:		
DEALER		MONTEREY	
NAME:	PHONE:		
DEALER/PHONE:	REPRESENTATIVE:		
SALESMAN:	ADDRESS:		
SERVICE MANAGER:			
ADDRESS:	MONTEREY E-MAIL:		
		DEALER E-MAIL:	

All information, illustrations, and specifications contained in this manual are based on the latest product information available at the time of publication. Monterey Boats reserves the right to make changes at anytime, without notice, in colors, materials, equipment, specifications, and models.

Export Documentation

(For Export Only)

To be in compliance with European directives for recreational boats as published by the International Organization for Standardization (ISO) in effect at the time this boat was manufactured, we are providing the following information.

Manufacturer:

Name SEABRING MARINE INDUSTRIES, INC., d.b.a. Monterey Boats
Address 1579 SW 18th St.
Williston, FL Zip Code: 32696

Identification Numbers:

Hull Identification Number US-RGF
Engine Serial Number _____

Intended Design Category:

- Ocean (Cat A) Inshore (Cat C)
- Offshore (Cat B) Sheltered Waters (Cat D)

Weight and Maximum Capacities:

Unladen Weight - Kilograms (Pounds) _____
Maximum Load - Weight- Kilograms (Pounds) _____
Number of People _____
Maximum Rated Engine Horsepower - Kilowatts (Horsepower) _____

Certifications:

Certifications & Components Covered See Declaration of conformity
Boat certified by IMCI (#0009) under certificate BMOHT025

All instructions given in this book are as seen from the stern looking toward the bow with starboard being to your right, and port to your left. The information and precautions listed in this manual are not all inclusive. It may be general in nature in some cases and detailed in others and is designed to provide you a basic understanding of your Monterey boat and some of the responsibilities that go along with owning/operating your boat.

The suppliers of some of the major components such as the engine, pumps, and appliances, provide their own owner's manuals which have been included with your boat. You should read the information in this manual and the manuals of other suppliers completely and have a thorough understanding of all component systems and their proper operation before operating your boat.

REMEMBER - IT IS YOUR RESPONSIBILITY TO ENSURE THAT YOUR BOAT IS SAFE FOR YOU AND YOUR PASSENGERS. ALWAYS EXERCISE GOOD COMMON SENSE WHEN INSTALLING EQUIPMENT AND OPERATING THE BOAT.

Warranty and Warranty Registration Cards

The Monterey Limited Warranty Statement is included with your boat. It has been written to be clearly stated and easily understood. If you have any questions after reading the warranty, please contact the Monterey Boats Customer Service Department

Monterey, engine manufacturers, and the suppliers of major components maintain their own manufacturer's warranty and service facilities. It is important that you properly complete the warranty registration cards included with your boat and engine and mail them back to the manufacturer to register your ownership. This should be done within 15 days of the date of purchase and before the boat is put into service. A form for recording this information for your records is provided at the beginning of this manual. This information will be important for you and service personnel to know, if and when you may need service or technical information.

The boat warranty registration requires the **Hull Identification Number "HIN"** which is located on the starboard side of the transom, just below the rubrail. The engine warranty registration requires the engine serial numbers. Please refer to the engine owner's manual for the location of the serial numbers.



Hull ID # On Starboard Side of Transom

IMPORTANT:

The terms and conditions of the Monterey Boats Limited Warranty are outlined in the warranty statement included in this manual. The manufacturer will automatically honor the warranty to the original purchaser for 15 days from the date of purchase. However, during that 15 day period, owners must comply with the steps outlined in the warranty statement to validate their warranty.

All boat manufacturers are required by the Federal Boat Safety Act of 1971 to notify first time owners in the event any defect is discovered "which creates a substantial risk of personal injury to the public." ***It is essential that we have your warranty registration card complete with your name and mailing address in our files so that we can comply with the law if it should become necessary.***

Your Monterey Boats Dealer will assist you in filling in the hull number and other data required on your Registration Card. Check to see that your card is complete and signed. Detach and mail. Your Warranty Registration Card will be added to our permanent files.

Notice:

Your dealer will also submit the registration electronically “on-line.”

Transferring the Limited Structural Warranty

For a transfer fee, MONTEREY BOATS will offer to extend a Transferable Limited Structural Hull Warranty to subsequent owners of Monterey boats. Please refer to the Monterey Limited Warranty Statement for the terms and conditions of the Transferable Limited Structural Hull Warranty and the procedure to transfer the warranty.

Product Changes

Monterey is committed to the continuous improvement of our boats. As a result, some of the equipment described in this manual or pictured in the catalog may change or no longer be available. **All information, illustrations, and specifications contained in this manual are based on the latest product information available at the time of publication. Monterey Boats reserves the right to make changes at any-time, without notice, in colors, materials, equipment, specifications, and models.** If

you have questions about the equipment on your Monterey, please contact the Monterey Boats Customer Service Department.

Service

All warranty repairs must be performed by an authorized Monterey Dealer. Should a problem develop that is related to faulty workmanship or materials, as stated in the Limited Warranty, you should contact your Monterey dealer to arrange for the necessary repair. If you are not near your dealer or another authorized Monterey dealer or the dealer fails to remedy the cause of the problem, then contact Monterey within 15 days. **It is the boat owner’s responsibility to deliver the boat to the dealer for warranty service.**

Registration and Numbering

Federal law requires that all undocumented vessels equipped with propulsion machinery be registered in the State of principal use. A certificate of number will be issued upon registering the boat. These numbers must be displayed on your boat. The owner/operator of a boat must carry a valid certificate of number whenever the boat is in use. When moved to a new State of principal use, the certificate is valid for 60 days.

In order to be valid, the numbers must be installed to the proper specifications. Check with your dealer or state boating authority for numbering requirements. The Coast Guard issues the certificate of number in Alaska; all others are issued by the state.

Insurance

In most States the boat owner is legally responsible for damages or injuries he or someone else operating the boat causes. Responsible boaters carry adequate liability and property damage insurance for their boat. You should also protect the boat against physical damage and theft. Some States have laws requiring minimum insurance coverage. Contact your dealer or state boating authority for information on the insurance requirements in your boating area.

Reporting Boating accidents

All boating accidents must be reported by the operator or owner of the boat to the proper marine law enforcement authority for the state in which the accident occurred. Immediate notification is required if a person dies or disappears as a result of a recreational boating accident.

If a person dies or there are injuries requiring more than first aid, a formal report must be filed within 48 hours.

A formal report must be made within 10 days for accidents involving more than \$500.00 damage or the complete loss of a boat.

A Boating Accident Report form is located near the back of this manual to assist you in reporting

an accident. If you need additional information regarding accident reporting, please call the Boating Safety Hotline, 800-368-5647.

Education

If you are not an experienced boater, we recommend that the boat operator and other people that normally accompany the operator, enroll in a boating safety course. Organizations such as the U.S. Power Squadrons, United States Coast Guard Auxiliary, State Boating Authorities and the American Red Cross offer excellent boating educational programs. These courses are worthwhile even for experienced boaters to sharpen your skills or bring you up to date on current rules and regulations. They can also help in providing local navigational information when moving to a new boating area. Contact your dealer, State Boating Authority or the Boating Safety Hotline, 800-368-5647 for further information on boating safety courses.

Required Equipment

U.S. Coast Guard regulations require certain equipment on each boat. The Coast Guard also sets minimum safety standards for vessels and associated equipment. To meet these standards some of the equipment must be Coast Guard approved. "Coast Guard Approved Equipment" has been determined to be in compliance with USCG specifications and regulations relating to performance, construction, or materials. The equipment requirements vary according to the length, type of boat, and the propulsion system. Some of the Coast Guard equipment is described in the Safety Equipment chapter of this manual. For a more detailed description, obtain "Federal Requirements And Safety Tips For Recreational Boats" by contacting the Boating Safety Hotline 800-368-5647 or your local marine dealer or retailer.

Some state and local agencies impose similar equipment requirements on waters that do not fall under Coast Guard jurisdiction. These agencies may also require additional equipment that is not required by the Coast Guard. Your dealer or local boating authority can provide you with additional information for the equipment requirements for your boating area.

Your Monterey boat is inspected at each step of the manufacturing process. Before leaving the factory, every Monterey boat undergoes a thorough check for systems operation, fit and finish. Your Monterey Dealer also performs a Pre-Delivery inspection prior to final delivery. When the new boat is delivered to you, the customer, a final check is performed during orientation. Both the Pre-Delivery and Final Delivery inspections are documented to ensure trouble free operation and returned to Monterey Boats.

At the time of new boat delivery, your Monterey Dealer will ask you to sign the completed Inspection Report at the same time as the Warranty Registrations for the boat and other accessory equipment. By signing these documents, you acknowledge that you have reviewed and understand all information.

WARRANTY REGISTRATION AND NEW BOAT CHECKLIST FOR ALL 2011 AND NEWER MODELS



**1579 S.W. 18th Street
Williston, FL 32696
Tel 352-529-9181
Fax 888-922-6287
www.montereyboats.com**

Boat Number (HIN): **RGF** _____ Boat Model: _____
 Selling Dealer: _____ Dealer Code: _____
 Engine Brand: _____ Engine Model: _____
 Engine Serial #1: _____ Drive Serial #1: _____
 Engine Serial #2: _____ Drive Serial #2: _____
 Date of Sale: _____ Warranty Start Date: _____
 Owner Name (Last, First): _____
 Address: _____
 City: _____ Province/State: _____ Postal Code/Zip: _____ Country _____
 E-Mail Address: _____ (We respect your privacy and will use for internal purposes only.)
 Phone: _____ 2nd Phone: _____

PLEASE, INSPECT AND CHECK OFF THE FOLLOWING OPERATIONS

Indicate Status with the following Key: √ or 1 - OK, 2 - Needs Correction, 3- Corrected, N/A - Not Applicable

<p><u>BOAT</u></p> <p>_____ Boat gel coat, striping & graphics _____ Upholstery fit, clean and free of defects _____ Sundeck/Sun Island/lounger operation _____ Canvas fit, clean and free of defects _____ Cabin Doors, port lights, hatches, cabinet & head doors, latches _____ All thru-hull fittings, ball valves, head drain, galley drain, anchor well drain, drain plug-hull, wet bar drain are secure, no leaks _____ Windshield fit _____ Ladders</p> <p><u>EQUIPMENT</u></p> <p>_____ Running Lights (Navigation) _____ Cabin lights, cockpit lights _____ Toilet (Head) operation & hoses _____ Stereo - Radio, CD, remote control _____ Bilge Pumps - Auto float switch _____ Air Conditioner/Heater - operation & components secure _____ Water pressure system (let pressure stand 15 minutes to see if pump goes on) & heater _____ Stove, coffee maker, oven, refrigerator, ice maker _____ Generator - Operation & components secure _____ Bilge Blower(s) _____ Wipers & Horn _____ Shore power (AC) _____ Tables _____ Plumbing Hose Clamps _____ Battery - Polarity, Voltage, Tight Connections _____ Battery Switch(es) - Operation</p> <p><u>ENGINE - BEFORE STARTING</u></p> <p>_____ Engine mounts - tight _____ Fuel system operation - no leaks _____ Engine compartment components not missing, disconnected, loose, kinked, pinched or could chafe _____ Hose clamps on engine & exhaust _____ Steering system operation, components secure, steering wheel straight _____ Drains cooling system closed (Closed cooling coolant level) _____ Throttle control, operation & adjustment _____ Shifter control, operation & adjustment _____ Stern drive oil level at full mark _____ Crankcase & power steering oil levels at full mark _____ Stern drive trim operation _____ Prop Size: _____ _____ Prop installed correctly with grease, nut(s), cotter pins _____ Prop rotation - Forward & Reverse _____ Neutral start switch, engine will not start in gear _____ Transom plate seal has no leaks - water, oil</p> <p>COMMENTS: _____ _____</p>	<p><u>ENGINE - AFTER STARTING: (in water)</u></p> <p>_____ Oil pressure _____ Fuel line connectors - no leaks _____ Engine has no water or oil leaks _____ Idle speed per engine specs, in gear _____ Ignition timing check with timing light or scan tool _____ Gear shift works properly - forward, neutral, reverse _____ Instruments read correctly _____ Exhaust system - no leaks</p> <p><u>SEA TRIAL</u></p> <p>_____ Boat performance _____ Port engine operation _____ Starboard engine operation _____ Steering -operation _____ Stern drive trim operation _____ Instruments register normal _____ Maximum R.P.M. _____</p> <p>Technical Check Performed by _____ Technician _____ Date _____</p> <p><u>PRE-DELIVERY FINAL CHECK</u></p> <p>_____ All accessory equipment operates (Mech. & Elect.) _____ Carpets, curtains, cushions & canvas installed _____ All boat, engine and accessory literature _____ Boat properly cleaned, interior and exterior _____ Trailer wiring, lights, wheels & brakes</p> <p><u>OWNER ORIENTATION</u></p> <p>_____ Review & familiarize Owner with operation of all features and options on boat _____ Sea Trial with Owner _____ Review of Owners Manual _____ Review of Warranties _____ Review of Owner Responsibilities _____ Review of Service & Maintenance Procedures _____ Review of Care & Cleaning</p> <p>Owner Orientation Performed by: _____ Dealer Personnel _____ Date _____</p> <p><i>I have read and agree with the checklist. I have read and understand the Monterey Boats Lifetime Limited Warranty as it appears on the back of this form.</i></p> <p>Signature of Boat Owner _____ Date _____</p>
---	---

SAFETY EQUIPMENT

1.1 General

Your boat and inboard engine have been equipped with safety equipment designed to enhance the safe operation of the boat and to meet U.S. Coast Guard safety standards. The Coast Guard or state, county, and municipal law enforcement agencies require certain additional accessory safety equipment on each boat. This equipment varies according to length and type of boat and type of propulsion. The accessory equipment typically required by the Coast Guard is described in this chapter. Some local laws require additional equipment. It is important to obtain "Federal Requirements And Safety Tips for Recreational Boats," published by the Coast Guard, and copies of state and local laws, to make sure you have the required equipment for your boating area.

Your boat is equipped with engine alarms and could be equipped with an optional automatic fire extinguishing system. These systems are designed to increase your boating safety by alerting you to potentially serious problems in the primary power system and the engine compartment. Alarm systems are not intended to lessen or replace good maintenance and precruise procedures.

This chapter also describes safety related equipment that could be installed on your boat. This equipment will vary depending on the type of engine and other options installed by you or your dealer.

1.2 Engine Alarm

Your boat is equipped with an engine alarm that monitors water temperature and oil pressure. The alarm is equipped with a buzzer and/or a light located in the helm. The alarm will sound if the water temperature reaches 205 degrees F. or the oil pressure drops below 6 P.S.I.

If there is a problem with one of these systems, it will sound an alarm until the problem is found and resolved.



Throwable Device & Personal PFD

If the alarm sounds:

- Immediately throttle the engine back to idle.
- Shift the transmission to neutral.
- Monitor the engine gauges to determine the cause of the problem.
- If necessary, shut off the engine and investigate until the cause of the problem is found.

1.3 Neutral Safety Switch

Every control system has a neutral safety switch incorporated into it. This device prohibits the engine from being started while the shift lever is in any position other than the neutral position. If the engine will not start, slight movement of the shift lever may be necessary to locate the neutral position and disengage the safety cutout switch. Control or cable adjustments may be required to correct this condition should it persist. See your Monterey dealer for necessary control and cable adjustments. Please refer to the Helm Control Systems chapter for more information on the neutral safety switch.

1.4 Engine Stop Switch

Single engine boats with a side mount throttle and shift control are equipped an engine stop switch and lanyard. When the lanyard is pulled it will engage the switch and shut off the engine. We strongly recommend that the lanyard be attached to the driver and the stop switch whenever the engine is running. If the engine will not start, it could be because the lanyard is not properly inserted into the engine stop switch. Always make sure the lanyard is properly attached to the engine stop switch before attempting to start the engine.

Notice:

In some states, a lanyard attached to the driver at all times is required by law.



Stop Switch & Lanyard

1.5 Required Safety Equipment

Besides the equipment installed on your boat by Monterey, certain other equipment is required by the U.S. Coast Guard to help ensure passenger safety. Items like a sea anchor, working anchor, extra dock lines, flare pistol, life vests, a line permanently secured to your ring buoy, etc., could at some time save your passengers' lives, or save your boat from damage. Refer to the "Federal Requirements And Safety Tips For Recreational Boats" pamphlet for a more detailed description of required equipment. You also can contact the U.S. Coast Guard Boating Safety Hotline, 800-368-5647, for information on boat safety courses and brochures listing the Federal equipment requirements. Also, check your local and state regulations.

The Coast Guard Auxiliary offers a "Courtesy Examination." This inspection will help ensure that your boat is equipped with all of the necessary safety equipment. The following is a list of the accessory equipment required on your boat by the U.S. Coast Guard:

Personal Flotation Devices (PFDs)

PFDs must be Coast Guard approved, in good and serviceable condition, and of appropriate size for the intended user. Wearable PFDs must be readily accessible, meaning you must be able to put them on in a reasonable amount of time in an emergency. Though not required, the Coast Guard emphasizes that PFDs should be worn at all times when the vessel is underway. Throwable devices must be immediately available for use. All Monterey boats must be equipped with at least one Type I, II or III PFD for each person on board, plus one throwable device (Type IV).

NOTICE:

Many state laws now require that children 13 years old and under must wear a PFD at all times.

Anyone being towed on skis, wakeboards and other water sports equipment is considered a passenger on the boat and must wear a Coast Guard approved life jacket at all times.

Visual Distress Signals (VDS)

All boats used on coastal waters, the Great Lakes, territorial seas, and those waters connected directly to them, must be equipped with Coast Guard approved visual distress signals. These signals are either Pyrotechnic or Non-Pyrotechnic devices.

Pyrotechnic Visual Distress Signals:

Pyrotechnic visual distress signals must be Coast Guard approved, in serviceable condition, and readily accessible. They are marked with a date showing the service life, which must not have expired. A minimum of three are required. Some pyrotechnic signals meet both day and night use requirements. They should be stored in a cool, dry location. They include:

- Pyrotechnic red flares, hand held or aerial.
- Pyrotechnic orange smoke, hand-held or floating.
- Launchers for aerial red meteors or parachute flares.

WARNING

PYROTECHNICS ARE UNIVERSALLY RECOGNIZED AS EXCELLENT DISTRESS SIGNALS. HOWEVER, THERE IS POTENTIAL FOR INJURY AND PROPERTY DAMAGE IF NOT PROPERLY HANDLED. THESE DEVICES PRODUCE A VERY HOT FLAME AND THE RESIDUE CAN CAUSE BURNS AND IGNITE FLAMMABLE MATERIAL. PISTOL LAUNCHED AND HAND-HELD PARACHUTE FLARES AND METEORS HAVE MANY CHARACTERISTICS OF A FIREARM AND MUST BE HANDLED WITH CAUTION. IN SOME STATES THEY ARE CONSIDERED A FIREARM AND PROHIBITED FROM USE. ALWAYS BE EXTREMELY CAREFUL AND FOLLOW THE MANUFACTURER'S INSTRUCTIONS EXACTLY WHEN USING PYROTECHNIC DISTRESS SIGNALS.

Non-Pyrotechnic Devices

Non-Pyrotechnic visual distress signals must be in serviceable condition, readily accessible, and certified by the manufacturer as complying with U.S. Coast Guard requirements. They include:

- Orange Distress Flag (Day use only)**
 The distress flag is a day signal only. It must be at least 3 x 3 feet with a black square and ball on an orange background. It is most distinctive when attached and waved from a paddle or boat hook.
- Electric Distress Light (Night use only)**
 The electric distress light is accepted for night use only and must automatically flash the international SOS distress signal. Under "Inland Navigation Rules," a high intensity white light flashing at regular intervals from 50-70 times per minute is considered a distress signal.

Sound Signaling Devices

The navigation rules require sound signals to be made under certain circumstances. Recreational vessels also are required to sound fog signals during periods of reduced visibility. Therefore, you must have some means of making an efficient sound signal.

Navigation Lights

Recreational boats are required to display navigation lights between sunset and sunrise and other periods of reduced visibility (fog, rain, haze, etc.) Navigation lights are intended to keep other vessels informed of your presence and course. Your boat is equipped with navigation lights required by the U.S. Coast Guard at the time of manufacture. It is up to you to make sure they are operational and turned on when required.

Fire Extinguishers

Inboard boats less than 26 feet are required to carry one fire extinguisher. Coast Guard approved fire extinguishers are hand-portable, either B-I or B-II classification and have a specific marine type mounting bracket. It is recommended the extinguisher be mounted in a readily accessible position.

Fire extinguishers require regular inspections to ensure that:

- Seals & tamper indicators are not broken or missing.
- Pressure gauges or indicators read in the operable range.
- There is no obvious physical damage, corrosion, leakage or clogged nozzles.



Refer to the "Federal Requirements And Safety Tips For Recreational Boats" pamphlet or contact the U.S. Coast Guard Boating Safety Hotline, 1-800-368-5647, for information on the type and size fire extinguisher required for your boat.

Please refer to the information provided by the fire extinguisher manufacturer for instructions on the proper maintenance and use of your fire extinguisher.

CAUTION

INFORMATION FOR AGENT FE-241 AND FE-227 FIRE EXTINGUISHERS IS PROVIDED BY THE MANUFACTURER. IT IS ESSENTIAL THAT YOU READ THE INFORMATION CAREFULLY AND COMPLETELY UNDERSTAND THE SYSTEM, IN THEORY AND OPERATION, BEFORE USING YOUR BOAT.

1.6 Bilge and Fuel Fires

Fuel compartment and bilge fires are very dangerous because of the presence of gasoline or diesel fuel in the various components of the fuel system and the possibility for explosion. You must make the decision to fight the fire or abandon the boat. If the fire cannot be extinguished quickly or it is too intense to fight, abandoning the boat may be your only option.

If you find yourself in this situation, make sure all passengers have a life preserver on, go over the side and swim well upwind of the boat. This will keep you and your passengers well clear of any burning fuel that could be released and spread on the water as the boat burns or in the event of an explosion. When clear of the danger, check about and account for all those who were aboard with you. Give whatever assistance you can to anyone in need or in the water without a buoyant device. Keep everyone together in a group for morale and to aid rescue operations.



Typical Fire Port

WARNING

ALL TYPES OF FUEL CAN EXPLODE. IN THE EVENT OF A FUEL COMPARTMENT OR BILGE FIRE, YOU MUST MAKE THE DIFFICULT DECISION TO FIGHT THE FIRE OR ABANDON THE BOAT. YOU MUST CONSIDER YOUR SAFETY, THE SAFETY OF YOUR PASSENGERS, THE INTENSITY OF THE FIRE AND THE POSSIBILITY OF AN EXPLOSION IN YOUR DECISION.

1.7 Fire Port

Some models are equipped with a fire port installed in the engine compartment hatch near the transom door as standard equipment. In the event of a fire in the engine compartment, do not open the hatch. This will supply more air to the fire making it more difficult to extinguish. Instead, leave the engine compartment hatch closed and insert the nozzle of the fire extinguisher into the fire port and discharge the extinguisher. Once the fire is extinguished, leave the engine compartment hatch closed until the compartment has had a chance to cool. This is particularly important when using FE-241 fire extinguishers. FE-241 is heavier than air and interferes with the combustion process. If the engine compartment hatch is opened too soon, the extinguishing agent could escape and a flash back could occur if the hot components have not cooled below a combustible temperature.



Fire Extinguisher Panel In Helm

WARNING

DO NOT OPEN THE ENGINE COMPARTMENT HATCH IMMEDIATELY!! THIS FEEDS OXYGEN TO THE FIRE AND FLASH BACK COULD RESULT. ALLOW THE ENGINE COMPARTMENT TO COOL FOR AT LEAST 15 MINUTES BEFORE CAUTIOUSLY INSPECTING FOR CAUSE OR DAMAGE. HAVE AN APPROVED PORTABLE FIRE EXTINGUISHER CLOSE AT HAND AND READY FOR USE. DO NOT BREATHE FUMES OR VAPORS CAUSED BY THE FIRE!

1.8 Automatic Fire Extinguishing System (Optional)

The engine compartment can be equipped with an automatic fire extinguishing system. The equipment has been chosen and located to provide sufficient volume and coverage of the entire engine compartment area. While the system ensures excellent bilge fire protection, it does not eliminate the U.S. Coast Guard requirement for hand held fire extinguishers. The automatic fire extinguishing system is automatically activated when the temperature in the engine compartment reaches a specific temperature, usually around 165° F.

The boat is equipped with an indicator light at the helm. Under normal circumstances, whenever the ignition key is turned on, the green indicator light will glow. This indicates that the system is

operating and ready for activation if necessary. If the indicator light does not glow when the ignition switch is turned on, either the system has discharged or there is a problem that should be corrected before using the boat.

The green light on the fire extinguisher panel will go off and an alarm will sound if activation should occur during the operation of the boat. You may also hear a rushing air sound as the extinguishing agent discharges.

Typically, the extinguishing agent will shut down the engine when it discharges. If the engine continues to run, it should immediately be shut down manually, provided it is safe to do so. You should also shut off the blower and the main battery switch. The engine can be restarted once the fire extinguishing agent has dissipated from the engine compartment.

When sufficient time has elapsed for the fire to be extinguished and a flashback is no longer possible, find and fix the problem, then activate the battery switch and the engine can be restarted.



Automatic Fire Extinguishing System
In The Engine Compartment

WARNING

IF ACTIVATION SHOULD OCCUR, IMMEDIATELY SHUT DOWN THE ENGINE. TURN OFF ALL ELECTRICAL SYSTEMS, POWERED VENTILATION AND EXTINGUISH ALL SMOKING MATERIALS. DO NOT OPEN THE ENGINE COMPARTMENT HATCH IMMEDIATELY!! THIS FEEDS OXYGEN TO THE FIRE AND FLASH BACK COULD RESULT. ALLOW THE EXTINGUISHING AGENT TO SOAK THE ENGINE COMPARTMENT FOR AT LEAST 15 MINUTES AND WAIT FOR HOT METALS OR FUELS TO COOL BEFORE CAUTIOUSLY INSPECTING FOR CAUSE OR DAMAGE. HAVE AN APPROVED PORTABLE FIRE EXTINGUISHER AT HAND AND READY FOR USE. DO NOT BREATHE FUMES OR VAPORS CAUSED BY THE FIRE!!

WARNING

THE OWNER'S MANUAL PROVIDED BY THE FIRE EXTINGUISHING SYSTEM MANUFACTURER SHOULD BE INCLUDED WITH YOUR BOAT. IT IS ESSENTIAL THAT YOU READ THE INFORMATION CAREFULLY AND COMPLETELY UNDERSTAND THE SYSTEM IN THEORY AND OPERATION BEFORE USING YOUR BOAT. IF YOU DID NOT RECEIVE THE FIRE EXTINGUISHING SYSTEM OWNER'S MANUAL, PLEASE CONTACT YOUR DEALER OR THE MONTEREY CUSTOMER SERVICE DEPARTMENT.

1.9 Carbon Monoxide Poisoning

A by product of combustion, carbon monoxide (CO) is invisible, tasteless, odorless, and is produced by all engines, heating and cooking appli-

ances. The most common sources of CO on boats are the engines, auxiliary generators and propane or butane stoves. These produce large amounts of CO and should never be operated while sleeping. A slight buildup of carbon monoxide over several hours causes headache, nausea and other symptoms that are similar to food poisoning, motion sickness or flu. High concentrations can be fatal within minutes. Many cases of carbon monoxide poisoning indicate that while victims are aware they are not well, they become so disoriented they are unable to save themselves by either exiting the area or calling for help. Also, young children, elderly persons, and pets may be the first affected.

Drug or alcohol use increases the effect of CO exposure. Individuals with cardiac or respiratory conditions are very susceptible to the dangers of carbon monoxide. CO poisoning is especially dangerous during sleep when victims are unaware of any side effects. The following are symptoms which may signal exposure to CO: (1) Headache (2) Tightness of chest or hyperventilation (3) Flushed face (4) Nausea (5) Drowsiness (6) Fatigue or Weakness (7) Inattention or confusion (8) Lack of normal coordination.

Persons who have been exposed to carbon monoxide should be moved into fresh air immediately. Have the victim breathe deeply and seek immediate medical attention. To learn more about CO poisoning, contact your local health authorities.

!
DANGER
!

CARBON MONOXIDE IS COLORLESS, ODORLESS AND DANGEROUS. ALL ENGINES, GENERATORS AND FUEL BURNING APPLIANCES EXHAUST CARBON MONOXIDE (CO). DIRECT AND PROLONGED EXPOSURE TO CO WILL CAUSE BRAIN DAMAGE OR DEATH. SIGNS OF EXPOSURE TO CO INCLUDE NAUSEA, DIZZINESS AND DROWSINESS.

1.10 First Aid

It is the operator's responsibility to be familiar with the proper first-aid procedures and be able to care for minor injuries or illnesses of your passengers. In an emergency, you could be far from professional medical assistance. We strongly recommend that you be prepared by receiving training in basic first aid and CPR. This can be done through classes given by the Red Cross or your local hospital.



Your boat also should be equipped with at least a simple marine first-aid kit and a first-aid manual. The marine first-aid kit should be designed for the marine environment and be well supplied. It should be accessible and each person on board should be aware of its location. As supplies are used, replace them promptly. Some common drugs and antiseptics may lose their strength or become unstable as they age. Ask a medical professional about the supplies you should carry and the safe shelf life of prescription drugs or other medical supplies that may be in your first-aid kit. Replace questionably old supplies whether they have been used or not.

In many emergency situations, the Coast Guard can provide assistance in obtaining medical advice for treatment of serious injuries or illness. If you are within VHF range of a Coast Guard Station, make the initial contact on channel 16 and follow their instructions.

1.11 Additional Safety Equipment

Besides meeting the legal requirements, prudent boaters carry additional safety equipment. This is particularly important if you operate your boat offshore. You should consider the following items, depending on how you use your boat.

Satellite EPIRBs

EPIRBs (Emergency Position Indicating Radio Beacon) operate as part of a worldwide distress system. When activated, EPIRBs will send distress code homing beacons that allow Coast Guard aircraft to identify and find them quickly. The satellites that receive and relay EPIRB signals are operated by the National Oceanic and Atmospheric Administration (NOAA) in the United States. The EPIRB should be mounted and registered according to the instructions provided with the beacon, so that the beacon's unique distress code can be used to quickly identify the boat and owner.

Marine Radio

A marine radio is the most effective method of receiving information and requesting assistance. VHF marine radios are used near shore and single sideband radios are used for long range communication.

There are specific frequencies to use in an emergency. The VHF emergency channel is 16 in the United States. You should read the owners manual for your radio and know how to use it in an emergency or for normal operation. If you hear a distress call you should assist or monitor the situation until help is provided.

Additional Equipment to Consider:

- | | |
|-------------------|------------------------|
| Cell Phone | Spare Anchor |
| Fenders | Heaving Line |
| Mirror | First Aid Kit |
| Tool Kit | Flashlight & Batteries |
| Anchor | Search light |
| Boat Hook | Sunburn Lotion |
| Mooring Lines | Ring Buoy |
| Binoculars | Whistle or Horn |
| Extra Clothing | Portable Radio |
| Chart and Compass | Marine Hardware |
| Food & Water | Spare Keys |
| Sunglasses | Spare Parts |
| Spare Propeller | |

1.12 Caution & Warning Labels

The caution and warning labels shown are examples of the labels that could be on your boat. The actual labels and their location could vary on your boat.

Caution and warning labels must remain legible for the safety of you and your passengers. If a label becomes missing or damaged it must be replaced. Immediately contact your dealer or Monterey Customer Service for a replacement.

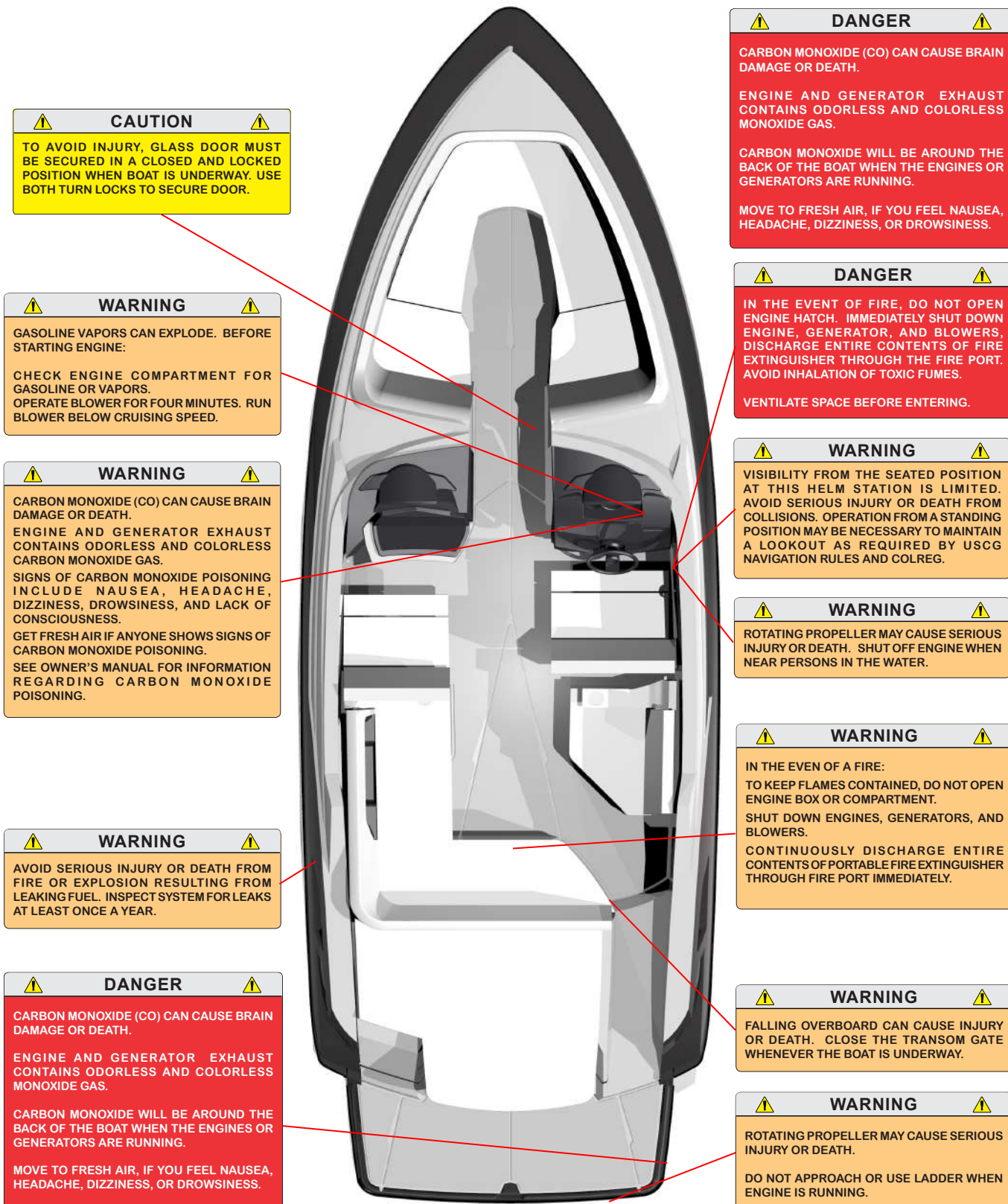

THIS PAGE WAS LEFT BLANK
INTENTIONALLY

OPERATION

2.1 General

Before you start the engine(s) on your Monterey, you should have become familiar with the various component systems and their operation and have performed a "Precruise System Check." A thorough understanding of the component systems and their operation is essential to the proper operation of the boat. This manual and the associated manufacturers' information is provided to enhance your knowledge of your boat. Please read them carefully.

Your boat must have the necessary safety equipment on board and be in compliance with the U.S. Coast Guard, local and state safety regulations. There should be one Personal Flotation Device (PFD) for each person. Non-swimmers and small children should wear PFDs at all times. You should know and understand the "Rules of the Road" and have had an experienced operator brief you on the general operation of your new boat. At least one other person should be instructed on the proper operation of the boat in case the operator is suddenly incapacitated.

The operator is responsible for his safety and the safety of his passengers. When boarding or loading the boat, always step onto the boat, never jump. All passengers should be properly seated whenever the boat is operated above idle speed. Your passengers should not be allowed to sit on the seat backs, gunnels, bows, or transoms whenever the boat is underway. The passengers also should be seated to properly balance the load and must not obstruct the operator's view, particularly to the front.

Overloading and improper distribution of weight can cause the boat to become unstable and are significant causes of accidents. Know the weight capacity and horsepower rating of your boat. Do not overload or overpower your boat.

You should be aware of your limitations and the limitations of your boat in different situations or sea conditions. No boat is indestructible, no matter how well it is constructed. Any boat can be severely damaged if it is operated in a manner that exceeds its design limitations. If the ride is hard on you and your passengers, it is hard on

the boat as well. Always modify the boat speed in accordance with the sea conditions, boat traffic and weather conditions.

Remember, it is the operator's responsibility to use good common sense and sound judgement in loading and operating the boat.

2.2 Rules of the Road

As in driving an automobile, there are a few rules you must know for safe boating operation. The following information describes the basic navigation rules and action to be taken by vessels in crossing, meeting or overtaking situations while operating in inland waters. These are basic examples and not intended to teach all the rules of navigation. For further information consult the "Navigation Rules" or contact the Coast Guard, Coast Guard Auxiliary, Department of Natural Resources, or your local boat club. These organizations sponsor courses in boat handling, including rules of the road. We strongly recommend such courses. Books or videos on this subject also are available from your local library.

NOTICE:

Sailboats not under power, paddle boats, vessels unable to maneuver, vessels engaged in commercial fishing and other vessels without power have the right of way over motor powered boats. You must stay clear or pass to the stern of these vessels. Sailboats under power are considered motor boats.

Crossing Situations

When two motor boats are crossing, the boat on the right has the right of way. The boat with the right of way should maintain its course and speed. The other vessel should slow down and permit it to pass. The boats should sound the appropriate signals.

Meeting Head-On or Nearly-So Situations

When two motor boats are approaching each other head-on or nearly head-on, neither boat has the right of way. Both boats should reduce their speed and turn to the right so as to pass port side to port side, providing enough clearance for safe passage. The boats should sound the appropriate signals.

Overtaking Situations

When one motor boat is overtaking another motor boat, the boat that is being passed has the right of way. The overtaking boat must make the adjustments necessary to provide clearance for a safe passage of the other vessel. The boats should sound the appropriate signals.

The General Prudential Rule

In obeying the Rules of the Road, due regard must be given to all dangers of navigation and collision, and to any special circumstances, including the limitations of the vessels, which may justify a departure from the rules that is necessary to avoid immediate danger or a collision.

Night Operation

Recreational boats are required to display navigation lights between sunset and sunrise and other periods of reduced visibility such as fog, rain, haze, etc. When operating your boat at night you should:

- Make sure your navigation lights are on and working properly. Navigation lights warn others of your position and course and the position and course of other vessels.
- All navigation rules apply. If the bow light of another vessel shows red, you should give way to that vessel, if it shows green, you have the right of way.
- Slow down and never operate at high speeds when operating at night, stay clear of all boats and use good common sense. Always be ready to slow down or steer clear of other vessels, even if you have the right-of-way.
- Avoid bright lights that can destroy night vision, making it difficult to see navigation lights and the lights of other boats. You and your passengers should keep a sharp lookout for hazards, other boats and navigational aids.

Navigation Aids

Aids to navigation are placed along coasts and navigable waters as guides to mark safe water and to assist mariners in determining their position in relation to land and hidden dangers. Each aid to navigation is used to provide specific information. You should be familiar with these and any other markers used in your boating area.

NOTICE:

Storms and wave action can cause buoys to move. You should not rely on buoys alone to determine your position.

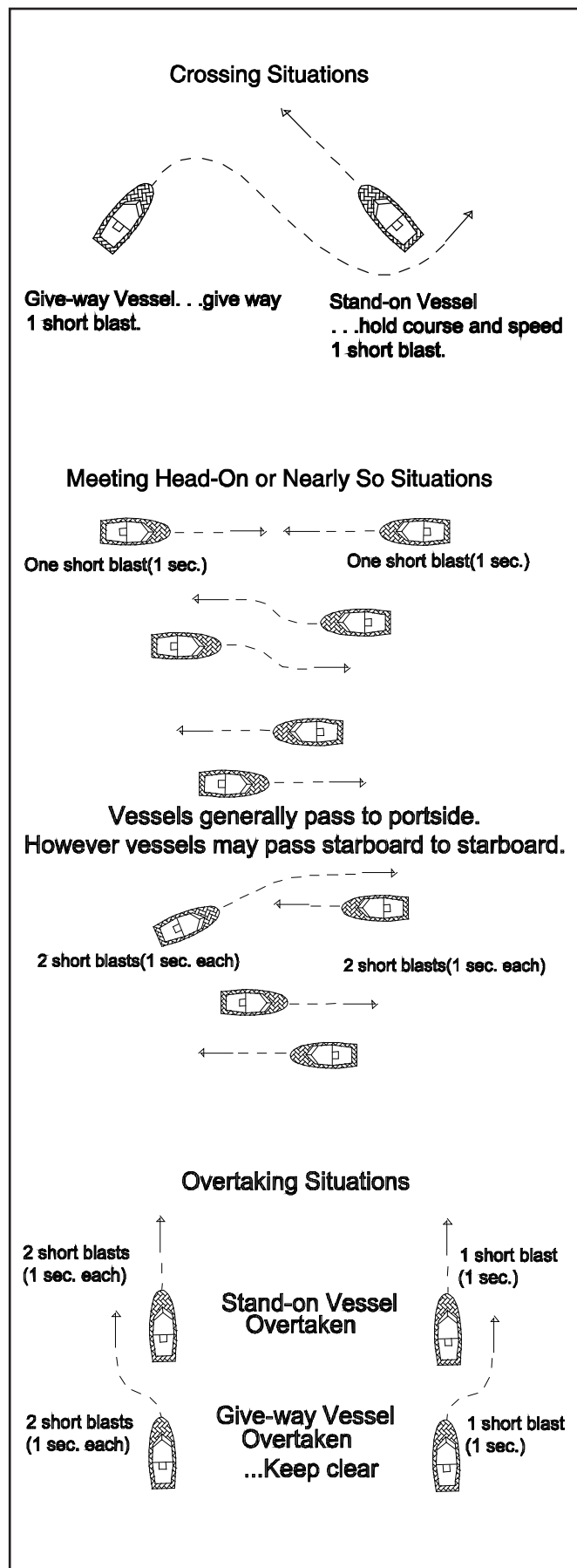

Navigational Aids Chart

REMEMBER THESE RULES

1. OVERTAKING - PASSING: Boat being passed has the right-of-way. KEEP CLEAR.
2. MEETING HEAD ON: Keep to the right.
3. CROSSING: Boat on right has the right-of-way. Slow down and permit boat to pass.

<p>← PORT</p> <p>Yield right-of-way to boats in your DANGER ZONE!</p> <p>STARBOARD →</p> <p>DANGER ZONE (Dead ahead to 2 points abaft your starboard beam)</p>	<p>STORM WARNINGS</p> <p>RED FLAG Small craft (winds up to 33 knots)</p> <p>2 RED FLAGS Gale (winds up to 47 knots)</p> <p>SQUARE RED FLAG BLACK BOX (Storm)</p> <p>2 SQUARE RED FLAGS BLACK BOX (Hurricane)</p>												
<p>WHISTLE SIGNALS</p> <p>ONE LONG BLAST: Warning signal (Coming out of slip)</p> <p>ONE SHORT BLAST: Pass on my port side</p> <p>TWO SHORT BLASTS: Pass on my starboard side</p> <p>THREE SHORT BLASTS: Engine(s) in reverse</p> <p>FOUR OR MORE BLASTS: Danger signal</p>	<p>BRIDGE SIGNALS</p> <table border="0"> <tr> <td>SOUND</td> <td>VISUAL</td> </tr> <tr> <td>VESSEL: Open </td> <td>VESSEL: Open </td> </tr> <tr> <td>BRIDGE: OK </td> <td>BRIDGE: OK </td> </tr> <tr> <td>No </td> <td>Same </td> </tr> <tr> <td>VESSEL: Replies: </td> <td>Same </td> </tr> <tr> <td>RADIO: VHF CH. 13</td> <td>No </td> </tr> </table>	SOUND	VISUAL	VESSEL: Open	VESSEL: Open	BRIDGE: OK	BRIDGE: OK	No	Same	VESSEL: Replies:	Same	RADIO: VHF CH. 13	No
SOUND	VISUAL												
VESSEL: Open	VESSEL: Open												
BRIDGE: OK	BRIDGE: OK												
No	Same												
VESSEL: Replies:	Same												
RADIO: VHF CH. 13	No												

LATERAL AIDS AS SEEN ENTERING FROM SEAWARD

<p>PORT SIDE ODD NUMBERED AIDS</p> <p>GREEN LIGHT ONLY</p> <p>FLASHING </p> <p>OCCULTING </p> <p>QUICK FLASHING </p> <p>ISOPHASE </p> <p> G "9" FI G 4sec</p> <p>LIGHTED BUOY</p> <p> CAN G "7"</p> <p> SG DAYMARK G "1"</p>	<p>SAFE WATER MID-CHANNELS OR FAIRWAYS NO NUMBERS — MAY BE LETTERED</p> <p><input type="checkbox"/> WHITE LIGHT ONLY</p> <p>Mo (A) </p> <p> SPHERICAL RW SP "G"</p> <p> MR RW "A"</p> <p> LIGHTED AND OR SOUND RW "N" Mo (A)</p> <p>PREFERRED CHANNEL NO NUMBERS — MAY BE LETTERED</p> <p>COMPOSITE GROUP FLASHING (2 + 1)</p> <p><input type="checkbox"/> <input type="checkbox"/> <input type="checkbox"/> <input type="checkbox"/> <input type="checkbox"/> <input type="checkbox"/></p> <p> GR "C" FI (2 + 1)</p> <p> RG "B" FI (2 + 1)</p> <p>LIGHTED</p> <p> CAN GR "L"</p> <p>PREFERRED CHANNEL TO STARBOARD TOPMOST BAND GREEN</p> <p> CAN RW "W"</p> <p> NUN RG "N"</p> <p> JG DAYMARK GR "A"</p> <p> JR DAYMARK RG "B"</p>	<p>STARBOARD SIDE EVEN NUMBERED AIDS</p> <p>RED LIGHT ONLY</p> <p>FLASHING </p> <p>OCCULTING </p> <p>QUICK FLASHING </p> <p>ISOPHASE </p> <p> LIGHTED BUOY R "8" FI R 4sec</p> <p> NUN R "6"</p> <p> TR DAYMARK R "2"</p>
--	--	---

2.3 Pre-Cruise Check

Before Starting the Engine:

- Check the weather forecast and sea conditions before leaving the dock. Decide if the planned cruise can be made safely.
- Be sure all required documents are on board.
- Be sure all necessary safety equipment is on board and operative. This should include items like the running lights, spotlight, life saving devices, etc. Please refer to the Safety Equipment chapter for additional information on safety equipment.
- Make sure you have signal kits and flare guns aboard, and they are current and in good operating condition.
- Be sure you have sufficient water and other provisions for the planned cruise.
- Leave a written message listing details of your planned cruise with a close friend ashore (Float Plan). The float plan should include a description of your boat, where you intend to cruise, and a schedule of when you expect to arrive in the cruising area, and when you expect to return. Keep the person informed of any changes in your plan to prevent false alarms. This information will tell authorities where to look and the type of boat to look for in the event you fail to arrive.
- Check the amount of fuel on board. Observe the "rule of thirds:" one third of the fuel for the trip out, one third to return and one third in reserve. An additional 15% may be consumed in rough seas.
- The engine fuel filter should be checked for leaks or corrosion.
- Turn the battery switch on.
- Check the bilge water level. Look for other signs of potential problems. Monitor for the scent of fuel fumes.
- Test the automatic and manual bilge pump switch to make sure the system is working properly.

- Turn on the bilge blower. Check the blower output and operate four (4) minutes before starting the engine. The blower also should be activated when operating below cruising speed.
- Have a tool kit aboard. The kit should include the following basic tools:

Spark plug wrench	Hammer
Spark plug gap gauge	Electrician's tape
Screwdrivers	Offset screwdrivers
Lubricating oil	Pliers
Jackknife	Adjustable wrench
Basic 3/8" ratchet set	Vise grip pliers
Allen wrench set	Needle nose pliers
Wire crimping tool	Wire connector Set
End wrench set	Medium slip-joint pliers
Diagonal cutting pliers	DC electrical test light



WARNING



THERE MUST BE AT LEAST ONE PERSONAL FLOTATION DEVICE ON BOARD FOR EVERY PERSON ON BOARD AND ONE THROW-OUT FLOTATION DEVICE. CHECK THE U.S. COAST GUARD STANDARDS FOR THE CORRECT TYPE OF DEVICE FOR YOUR BOAT.

- Have the following spare parts on board:

Extra light bulbs	Spark plugs
Fuses and	circuit breakers
Main 12 volt fuses	Assorted stainless screws
Assorted stainless bolts	Flashlight and batteries
Drain plugs	Engine oil
Transmission oil	Propellers
Propeller nuts	Fuel filters
Fuel hose and clamps	Wire ties
Engine cooling pump	Hydraulic oil
Impeller Kit	Assorted hose
Clamps	Rags
Steering fluid	Pump & alternator belts

- Make sure all fire extinguishers are in position and in good operating condition.

2.4 Operating Your Boat

After Starting the Engine or engines:

- Check the engine gauges. Make sure they are reading normally.
- Visibly check the engine to be sure there are no apparent water, fuel or oil leaks.
- Check the operation of the engine cooling system by monitoring the temperature gauge frequently until the engine temperature stabilizes at normal operating temperature.
- Check the steering and engine controls for proper operation.
- Make sure all lines, cables, anchors, etc. for securing a boat are on board and in good condition. All lines should be coiled, secured and off the decks when underway.
- Have a safe cruise and enjoy yourself.

Remember:

When you operate a boat, you accept the responsibility for the boat, for the safety of passengers and for others out enjoying the water.

- Alcohol and any drugs can severely reduce your reaction time and affect your better judgement.
- Alcohol severely reduces the ability to react to several different signals at once.
- Alcohol makes it difficult to correctly judge speed and distance, or track moving objects.
- Alcohol reduces night vision, and the ability to distinguish red from green.



WARNING



YOU SHOULD NEVER OPERATE YOUR BOAT WHILE UNDER THE INFLUENCE OF ALCOHOL OR DRUGS.

- Make sure one other person on the boat is instructed in the operation of the boat.
- Make sure the boat is operated in compliance with all state and local laws governing the use of a boat.



WARNING



DO NOT OPERATE THE BOAT UNLESS IT IS COMPLETELY ASSEMBLED. KEEP ALL FASTENERS TIGHT. KEEP ADJUSTMENTS ACCORDING TO SPECIFICATIONS.

- Always operate the blower when operating the boat below cruising speed to help cool the engine compartment and remove dangerous fumes.
- Avoid sea conditions that are beyond the skill and experience of you and your crew. Learn to understand weather patterns and indications for change. You should monitor NOAA weather broadcasts before leaving port and periodically while boating. If the weather deteriorates or a storm approaches, seek shelter in a safe harbor.
- Use caution during periods of reduced visibility due to weather or operation conditions. Reduce speed and designate a passenger to be a lookout for other boats, obstacles and navigational markers until you reach port or conditions improve.
- Your Monterey is a heavy boat that will produce a large wake at certain speeds. You are responsible for damage and injury caused by your boat's wake. Always observe no wake zones and be aware that your wake can endanger small vessels and their passengers. Always be courteous and slow down to reduce your wake when passing smaller boats.
- Before operating the boat for the first time, read the engine break-in procedures. The break-in procedures are found in the owner's manual for the engine. The manual is in the literature packet.
- As different types of engines are used to power the boat, have the dealer describe the operating procedures for your boat. For more instructions on "How To Operate The Boat," make sure you read the instructions given to you in the owner's manual for the engine or engines you have selected.

NOTICE:

For more instructions on safety, equipment and boat handling, enroll in one of the several free boating courses offered. For information on the courses offered in your area, call the "Boating Course Hotline," 1-800-368-5647.

NOTICE:

If the running gear hits an underwater object, stop the engine(s). Inspect the propulsion system for damage. If the system is damaged, contact your dealer for a complete inspection and repair of the unit.

To stop the boat, follow this procedure:

- Allow the engine(s) to drop to idle speed.
- Make sure the shift lever(s) is in the neutral position.

NOTICE:

If the engine(s) has been run at high speed for a long period of time, allow the engine to cool down by running it in the idle position for 3 to 5 minutes.

- Turn the ignition key(s) to the "OFF" position.
- Raise the trim tabs to the full up position.

After Operation:

- If operating in saltwater, wash the boat and all equipment with soap and water.
- Check the bilge area for debris and excess water.
- Fill the fuel tank to near full to reduce condensation. Allow enough room in the tank for the fuel to expand without being forced out through the vent.
- Turn off all electrical equipment except the automatic bilge pump.
- If you are going to leave the boat for a long period of time, put the battery main switch in the "OFF" position and close all sea cocks.
- Make sure the boat is securely moored.



CAUTION



TO PREVENT DAMAGE TO THE BOAT, CLOSE ALL SEACOCKS BEFORE LEAVING THE BOAT.

2.5 Single Engine Docking, Anchoring & Mooring

Docking and Dock Lines

Maneuvering the boat near the dock and securing the boat requires skill and techniques that are unique to the water and wind conditions and the layout of the dock. If possible, position a crew member at the bow and stern to man the lines and assist in docking operations. While maneuvering close to the dock, consideration must be given to the wind and current. You should anticipate the effect these forces will have on the boat and use them to help put the boat where you want it. It is important to practice in open water using an imaginary dock enough to develop a sense for the way your boat handles in a variety of docking scenarios. You must be able to foresee the possibilities and have solutions in mind before problems occur.

Approaching a dock or backing into a slip in high winds or strong currents requires a considerable amount of skill. If you are new to boat handling, you should take lessons from an experienced operator to learn how to maneuver your boat in tight quarters in less than ideal conditions. You should also practice away from the dock during windy conditions.

Dock lines are generally twisted or braided nylon. Nylon is strong and stretches to absorb shock. It also has a long life and is soft and easy on the hands. The line's size will vary with the size of the boat. Typically a 30 to 40 foot boat will use 5/8-inch line and a 20 to 30 foot boat will use 1/2-inch line. The number of lines and their configuration will vary depending on the dock, the range of the tide, and many other factors. Usually a combination of bow, stern and spring lines is used to secure the boat.

Maneuvering to the Dock

Approach the dock slowly at a 30 to 40 degree angle. Whenever possible, approach against the wind or current. Turn the outdrive straight & shift to neutral when you feel you have enough momentum to reach the dock. Use reverse on the engine while turning the steering wheel toward the dock to slow the boat and pull the stern toward the dock as the boat approaches. Straighten the outdrive and use the engine to stop the boat if it is still moving forward against the pilings. If you executed your approach properly, the boat will lightly touch the pilings at the same time the forward momentum is stopped. Have the dock lines ready and secure the boat as soon as it stops. Use fenders to protect the boat while it is docked. Keep the engine running until the lines are secured.

Backing into a Slip

Approach the slip with the stern against the wind or current and the outdrive straight ahead. Use the engine and turn the steering wheel to maneuver the boat into alignment with the slip. Reverse the engine and slowly back into the slip. Shift from reverse to neutral frequently to prevent the boat from gaining too much speed. Move the stern right and left by shifting the engine in and out of gear or turning the wheel. When nearly in the slip all the way, straighten the outdrive and shift to forward to stop. Keep the engine running until the lines are secured.

Securing Dock Lines

Securing a boat that is tied along side the dock typically requires a bow and stern line and two spring lines. The bow and stern lines are usually secured to the dock at a 40° angle aft of the stern cleat and forward of the bow cleat. The after bow spring line is secured to the dock at a 40° angle aft of the after bow spring cleat. The forward quarter spring line is secured to the dock at a 40° angle forward of the stern cleat or the stern spring cleat. The spring lines keep the boat square to the dock and reduce fore and aft movement while allowing the boat to move up and down with the tide.

Securing a boat in a slip is somewhat different. It typically requires two bow lines secured to pilings on each side of the bow, two stern lines secured to the dock and two spring lines that prevent the boat from hitting the dock. The bow lines are typically secured with enough slack to allow the boat to ride the tide. The stern lines are crossed. One line runs from the port aft boat cleat to the starboard dock cleat and the other line runs from

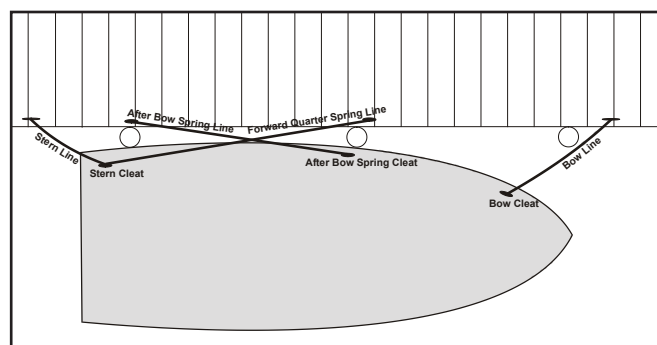

Securing The Boat Along Side A Dock (Typical)

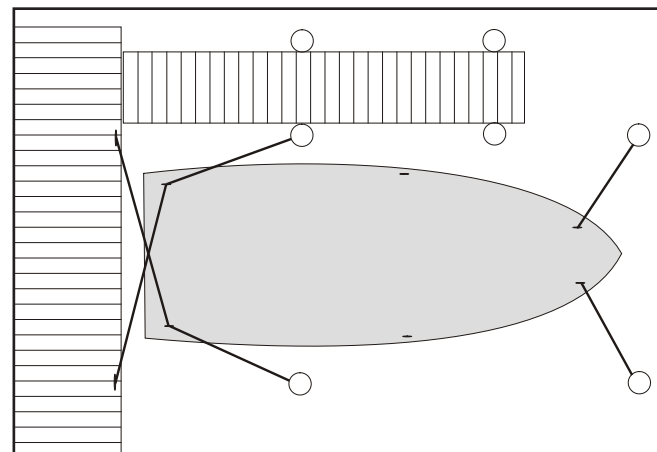

Securing The Boat In A Slip (Typical)

the starboard aft boat cleat to the port cleat on the dock. The stern lines center the boat, control the forward motion, and allow the boat to ride the tide. Two forward quarter spring lines typically are secured to the stern cleats and to mid ship pilings or cleats. The spring lines keep the boat from backing into the dock while allowing it to ride the tide.

Leaving the Dock

Always start the engine and let it warm up for several minutes before releasing the lines. Boats steer from the stern and it is important that you achieve enough clearance at the stern to maneuver the boat as quickly as possible. Push the stern off and maneuver such that you get stern clearance quickly. Proceed slowly until well clear of the dock and other boats.

Mooring

Approach the mooring heading into the wind or current. Shift to neutral when you have just enough headway to reach the buoy. Position a crew member on the bow to retrieve the mooring with a boat hook and secure the line. Keep the engine running until the line is secured.

Leaving a Mooring

Start the engine and let it warm up for several minutes before releasing the mooring line. The boat will already be headed into the wind, so move it forward enough to loosen the line and untie it. Back the boat away from the mooring until you can see the buoy. Move the boat slowly away from the mooring.

Anchoring

Make sure the bitter end of the anchor line is attached to boat before dropping the anchor. Bring the bow into the wind or current and put the engine in neutral. When the vessel comes to a stop, lower the anchor over the bow. Pay out anchor line so that it is at least 5 to 7 times the depth of the water and secure the line to a cleat. Use caution to avoid getting your feet or hands tangled in the line. Additional scope of 10 times the depth may be required for storm conditions. Check landmarks on shore to make sure the anchor is not dragging. If it is dragging, you will have to start all over. It is prudent to use two anchors if you are anchoring overnight or in rough weather.

Releasing the Anchor

Release the anchor by driving the boat slowly to the point where the anchor line becomes vertical. It should release when you pass that point. If the anchor doesn't release right away, stop the boat directly above the anchor and tie the line to the cleat as tight as possible. The up and down movement of the boat will usually loosen the anchor within a minute. Make sure you secure the anchor and properly stow the line before operating the boat.



WARNING



NEVER ANCHOR THE BOAT BY THE STERN. THE STERN OF THE BOAT IS VULNERABLE TO SWAMPING FROM WAVE ACTION AND WIND AND CURRENT WILL PUT MORE STRESS ON THE ANCHOR WHEN IT IS ATTACHED TO THE STERN. ONLY ANCHOR THE BOAT BY THE BOW

2.6 Twin Engine Docking, Anchoring & Mooring

Docking and Dock Lines

Maneuvering the boat near the dock and securing the boat requires skill and techniques that are unique to the water and wind conditions and the layout of the dock. If possible, position a crew member at the bow and stern to man the lines and

assist in docking operations. While maneuvering close to the dock, consideration must be given to the wind and current. You should anticipate the effect these forces will have on the boat and use them to help put the boat where you want it. It is important to practice in open water using an imaginary dock enough to develop a sense for the way your boat handles in a variety of docking scenarios. You must be able to foresee the possibilities and have solutions in mind before problems occur.

Approaching a dock or backing into a slip in high winds or strong currents requires a considerable amount of skill. If you are new to boat handling, you should take lessons from an experienced pilot to learn how to maneuver your boat in tight quarters in less than ideal conditions. You should also practice away from the dock during windy conditions.

Dock lines are generally twisted or braided nylon. Nylon is strong and stretches to absorb shock. It also has a long life and is soft and easy on the hands. The line's size will vary with the size of the boat. Typically a 30 to 40 foot boat will use 5/8-inch line and a 20 to 30 foot boat will use 1/2-inch line. The number of lines and their configuration will vary depending on the dock, the range of the tide, and many other factors. Usually a combination of bow, stern and spring lines is used to secure the boat.

Maneuvering to the Dock

Approach the dock slowly at a 30 to 40 degree angle. Whenever possible, approach against the wind or current. Turn the outdrives straight & shift to neutral when you feel you have enough momentum to reach the dock. Use reverse on the engines while turning the steering wheel toward the dock to slow the boat and pull the stern toward the dock as the boat approaches. Straighten the outdrives and use the engines to stop the boat if it is still moving forward against the pilings. If you executed your approach properly, the boat will lightly touch the pilings at the same time the forward momentum is stopped. Have the dock lines ready and secure the boat as soon as it stops. Use fenders to protect the boat while it is docked. Keep the engines running until the lines are secured.

Backing into a Slip

Approach the slip with the stern against the wind or current and the outdrives straight ahead. Use the engines and turn the steering wheel to

maneuver the boat into alignment with the slip. Reverse the engines and slowly back into the slip. Shift from reverse to neutral frequently to prevent the boat from gaining too much speed. Move the stern right and left by shifting the engines in and out of gear or turning the wheel. When nearly in the slip all the way, straighten the outdrives and shift to forward to stop. Keep the engines running until the lines are secured.

Securing Dock Lines

Securing a boat that is tied along side the dock typically requires a bow and stern line and two spring lines. The bow and stern lines are usually secured to the dock at a 40° angle aft of the stern cleat and forward of the bow cleat. The after bow spring line is secured to the dock at a 40° angle aft of the after bow spring cleat. The forward quarter spring line is secured to the dock at a 40° angle forward of the stern cleat or the stern spring cleat. The spring lines keep the boat square to the dock and reduce fore and aft movement while allowing the boat to move up and down with the tide.

Securing a boat in a slip is somewhat different. It typically requires two bow lines secured to pilings on each side of the bow, two stern lines secured to the dock and two spring lines that prevent the boat from hitting the dock. The bow lines are typically secured with enough slack to allow the boat to ride the tide. The stern lines are crossed. One line runs from the port aft boat cleat to the starboard dock cleat and the other line runs from the starboard aft boat cleat to the port cleat on the dock. The stern lines center the boat, control the forward motion, and allow the boat to ride the tide. Two forward quarter spring lines typically are secured to the stern cleats and to mid ship pilings or cleats. The spring lines keep the boat from backing into the dock while allowing it to ride the tide.

Leaving the Dock

Always start the engines and let them warm up for several minutes before releasing the lines. Boats steer from the stern and it is important that you achieve enough clearance at the stern to maneuver the boat as quickly as possible. Push the stern off and maneuver such that you get stern clearance quickly. Proceed slowly until well clear of the dock and other boats.

Mooring

Approach the mooring heading into the wind or current. Shift to neutral when you have just enough headway to reach the buoy. Position a

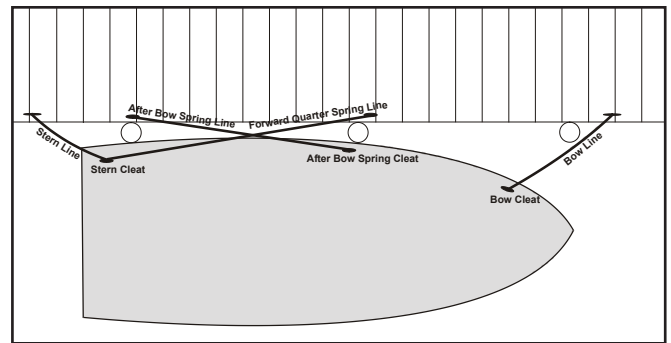

Securing The Boat Along Side A Dock (Typical)

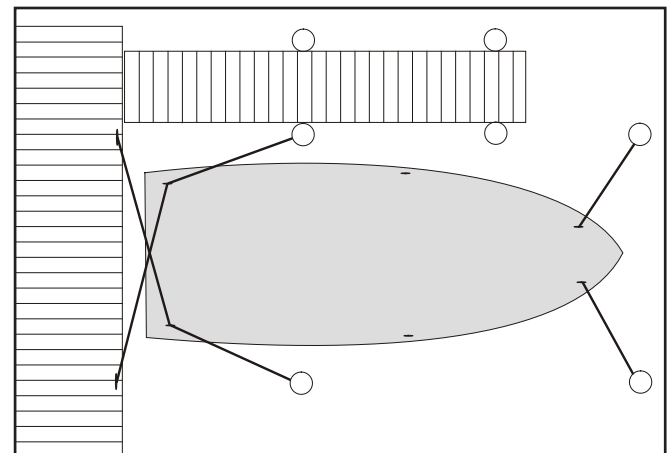

Securing The Boat In A Slip (Typical)

crew member on the bow to retrieve the mooring with a boat hook and secure the line. Keep the engines running until the line is secured.

Leaving a Mooring

Start the engines and let them warm up for several minutes before releasing the mooring line. The boat will already be headed into the wind, so move it forward enough to loosen the line and untie it. Back the boat away from the mooring until you can see the buoy. Move the boat slowly away from the mooring.

Anchoring

Make sure the bitter end of the anchor line is attached to boat before dropping the anchor. Bring the bow into the wind or current and put the engine in neutral. When the vessel comes to a stop, lower the anchor over the bow. Pay out anchor line so that it is at least 5 to 7 times the depth of the water and secure the line to a cleat. Use caution to avoid getting your feet or hands tangled in the line. Additional scope of 10 times the depth may be required for storm conditions. Check

landmarks on shore to make sure the anchor is not dragging. If it is dragging, you will have to start all over. It is prudent to use two anchors if you are anchoring overnight or in rough weather.

Releasing the Anchor

Release the anchor by driving the boat slowly to the point where the anchor line becomes vertical. It should release when you pass that point. If the anchor doesn't release right away, stop the boat directly above the anchor and tie the line to the cleat as tight as possible. The up and down movement of the boat will usually loosen the anchor within a minute. Make sure you secure the anchor and properly stow the line before operating the boat.



WARNING



NEVER ANCHOR THE BOAT BY THE STERN. THE STERN OF THE BOAT IS VULNERABLE TO SWAMPING FROM WAVE ACTION AND WIND AND CURRENT WILL PUT MORE STRESS ON THE ANCHOR WHEN IT IS ATTACHED TO THE STERN. ONLY ANCHOR THE BOAT BY THE BOW

2.7 Controls, Steering or Propulsion System Failure

If the propulsion, control or steering system fails while you are operating the boat, bring the throttle to idle and shift to neutral. Decide whether you need to put out the anchor to prevent the boat from drifting or to hold the bow into the seas. Investigate and correct the problem if you can. Turn the engine(s) off before going into the engine compartment to make repairs. If you are unable to correct the problem, call for help.

If your boat is equipped with twin engines and only one engine has failed, you can usually run home on the other engine. Be careful not to apply too much power to the engine that is running. When only one engine is used to power a twin engine boat, that engine is over propped and can be overloaded if too much throttle is applied. You should contact your dealer or the engine manufacturer for the maximum power settings when running on one engine.

2.8 Collision

If your boat is involved in a collision with another boat, dock, piling or a sandbar, your first priority is to check your passengers for injuries and administer first aid if necessary. Once your passengers situations are stabilized, thoroughly inspect the boat for damage. Check below decks for leaks and the control systems for proper operation. Plug all leaks or make the necessary repairs to the control systems before proceeding slowly and carefully to port. Request assistance if necessary. Haul the boat and make a thorough inspection of the hull and running gear for damage.

2.9 Grounding, Towing & Rendering Assistance

The law requires the owner or operator of a vessel to render assistance to any individual or vessel in distress, as long as his vessel is not endangered in the process.

If the boat should become disabled, or if another craft that is disabled requires assistance, great care must be taken. The stress applied to a boat during towing may become excessive. Excessive stress can damage the structure of the boat and create a safety hazard for those aboard.



Freeing a grounded vessel or towing a boat that is disabled, requires specialized equipment and knowledge. Line failure and structural damage caused by improper towing have resulted in fatal injuries. Because of this, we strongly suggest that these activities be left to those who have the equipment and knowledge, e.g., the U.S. Coast Guard or a commercial towing company, to safely accomplish the towing task.





DANGER



THE MOORING CLEATS, SKI TOW FITTINGS, WAKEBOARD TOWERS AND ARCHES ON MONTEREY BOATS ARE NOT DESIGNED OR INTENDED TO BE USED FOR TOWING PURPOSES. THE CLEATS ARE SPECIFICALLY DESIGNED AS MOORING CLEATS FOR SECURING THE BOAT TO A DOCK, PIER, ETC. THE SKI TOW FITTINGS ARE SPECIFICALLY DESIGNED FOR PULLING WATER SKIERS. DO NOT USE THESE FITTINGS FOR TOWING OR ATTEMPTING TO FREE A GROUND VESSEL.

 **WARNING** 

WHEN TOWING OPERATIONS ARE UNDERWAY, HAVE EVERYONE ABOARD BOTH VESSELS STAY CLEAR OF THE TOW LINE AND SURROUNDING AREA. A TOW LINE THAT SHOULD BREAK WHILE UNDER STRESS CAN BE VERY DANGEROUS, AND COULD CAUSE SERIOUS INJURY OR DEATH.

 **WARNING** 

RUNNING AGROUND CAN CAUSE SERIOUS INJURY TO PASSENGERS AND DAMAGE TO A BOAT AND ITS UNDERWATER GEAR. IF YOUR BOAT SHOULD BECOME GROUNDED, DISTRIBUTE PERSONAL FLOTATION DEVICES AND INSPECT THE BOAT FOR POSSIBLE DAMAGE. THOROUGHLY INSPECT THE BILGE AREA FOR SIGNS OF LEAKAGE. AN EXPERIENCED SERVICE FACILITY SHOULD CHECK YOUR UNDERWATER GEAR AT THE FIRST OPPORTUNITY. DO NOT CONTINUE TO USE YOUR BOAT IF THE CONDITION OF THE UNDERWATER EQUIPMENT IS QUESTIONABLE.

2.10 Flooding or Capsizing

Boats can become unstable if they become flooded or completely swamped. You must always be aware of the position of the boat to the seas and the amount of water in the bilge. Water entering the boat through the transom door or over the stern gunnels can usually be corrected by turning the boat into the waves. If the bilge is flooding because of a hole in the hull or a defective hose, you may be able to plug it with rags, close the thru-hull valve or assist the bilge pump by bailing with buckets. Put a mayday call in to the Coast Guard or nearby boats and distribute life jackets as soon as you discover your boat is in trouble.

If the boat becomes swamped and capsizes, you and your passengers should stay with the boat as long as you can. It is much easier for the Coast Guard, aircraft, or other boats to spot, than people in the water. If your boat is equipped with an EPIRB, make sure it is activated. When activated, EPIRBs will send distress code homing beacons that allow Coast Guard aircraft to identify your boat and find you quickly.

2.11 Fishing

Fishing can be very exciting and distracting for the operator when the action gets intense. You must always be conscious of the fact that your primary responsibility is the safe operation of your boat and the safety of your passengers and other boats in the area.

You must always make sure the helm is properly manned and is never left unattended while trolling. If you are fishing in an area that is crowded with other fishing boats, it may be difficult to follow the rules of the road. This situation can become especially difficult when most boats are trolling. Being courteous and exercising good common sense is essential. Avoid trying to assert your right of way and concentrate on staying clear and preventing tangled or cut lines and other unpleasant encounters with other boats. Also keep in mind that fishing line wrapped around a propeller shaft can damage the seal in the lower unit.

2.12 Water Skiing & Wakeboarding

Your boat is equipped for water skiing and wakeboarding. If you have never driven skiers before, you should spend some hours as an observer and learn from an experienced driver. If you are an experienced driver, you should take some time to become familiar with the boat and the way it handles before pulling a skier. The driver should also know the skier's ability and drive accordingly.

Always use high quality tow ropes with attachment loops when pulling wakeboarders or skiers and only attach the tow rope to the ski tow fittings on the transom, arch or wakeboard tower. Never use mooring cleats or grab rails to pull skiers. They are not designed for towing skiers and injury to skiers or passengers and/or damage to the boat could result.

The tow rope should always be attached using the attachment loops and never tied to the ski tow or to any type of metal hook attached to the tow fitting. Tied ski ropes are very difficult to remove and metal hooks will damage the ski tow fitting and the fiberglass around it. Metal hooks also can cause injury to your skiers if the metal hook breaks under the strain of the tow.

When attaching a tow rope using the attachment loops, hold the attachment loop in one hand and pull a length of rope on the handle side of the loop through the loop, creating another 6" loop. Slide the loop just created over the ski tow fitting and pull the handle side of the rope to tighten the loop around the tow fitting. This procedure will attach the rope securely to the ski tow, be easy to remove and will not come off if the skier or wakeboarder falls.

WARNING

THE ARCH AND WAKEBOARD TOWER ARE DESIGNED FOR TOWING WATER SPORTS DEVICES ONLY. DO NOT TOW MORE THAN ONE PERSON AT A TIME FROM THE TOWER OR ARCH. IMPROPER USE OR OVERLOADING THE TOWER MAY CAUSE DAMAGE TO THE TOWER AND/OR BOAT AND COULD IMBALANCE THE BOAT CAUSING HANDLING DIFFICULTIES.

- DO NOT ALLOW PASSENGERS TO SIT BEHIND THE ROPE ATTACHMENT POINT WHEN THE WAKEBOARD TOWER OR ARCH ARE IN USE.
- DO NOT ALLOW THE LOOSE END OF A TOW ROPE TO DANGLE FROM THE ARCH OR TOWER DOWN INTO THE COCKPIT DURING WATER SPORTS ACTIVITIES.

FAILURE TO ADHERE TO THESE GUIDELINES MAY CAUSE PERSONAL INJURY OR DEATH TO PASSENGERS.

The following safety precautions should be observed while towing water skiers.

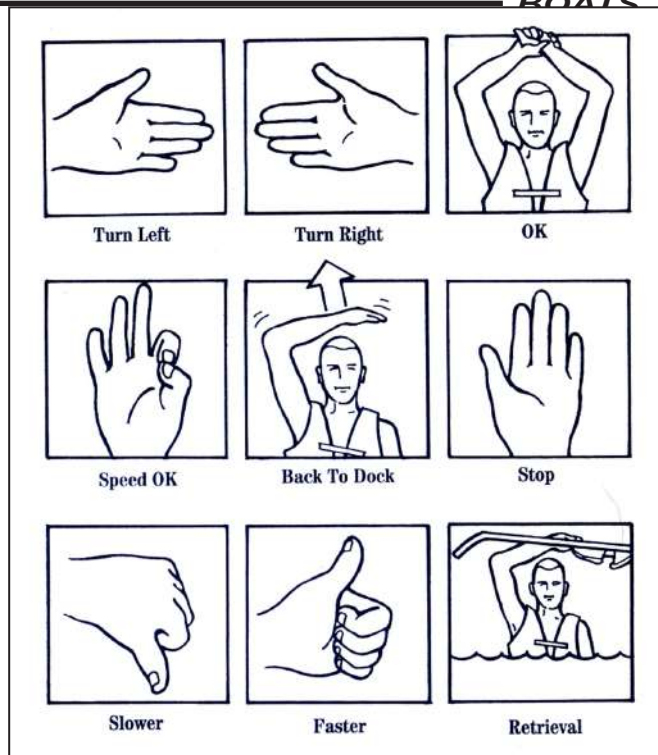

- Water ski only in safe areas, away from other boats and swimmers, out of channels, and in water free of underwater obstructions. The area should be at least 5 feet deep, 3000 feet long and have at least 100' between each side of the boat and any obstructions.
- Make sure that anyone who skis can swim. Do not allow people who cannot swim to water ski.
- Be sure that the skier is wearing a proper life jacket. A water skier is considered on board the boat and a Coast Guard approved life jacket is required. It is advisable and recommended for a skier to wear a flotation device designed to withstand the impact of hitting the water at high speed.
- Make sure to inspect the ski equipment and tow rope before each ski session. Never use equipment that is damaged or with loose screws, torn boots, severe corrosion or tears in the fabric. You should also inspect the ski tow rope and replace if it is frayed, has unnecessary knots or damage. Never use a ski tow line that is questionable.
- Always carry a second person on board to observe the skier or wakeboarder so that your full attention can be given to the safe operation of the boat. The operator should pay attention to driving the boat and have the observer keep him updated on the skier. Never ski after dark. It is hazardous and illegal. Neither the boat operator or skier can see well enough to navigate at skiing or wakeboarding speeds safely at night.



Common Hand Signals for Water Sports Activities

- Never spray swimmers, boats, rafts or other skiers. The risk for a collision makes this dangerous for the skier and people being sprayed.
- Some lakes have an approved tow pattern for skiing. Always make sure to follow the pattern on these lakes.
- Never follow directly behind another boat while pulling skiers. Always stay a safe distance behind or off the side of other boat traffic. If the boat you are following stops unexpectedly, you may not be able to respond quick enough endangering your skier and occupants of both boats.
- Never follow behind another boat pulling a skier for any reason, even if you are not pulling a skier. If the skier you are following falls, you may not be able to respond quick enough and could run over the skier.
- When pulling multiple skiers, make sure the ropes are the same length. Never pull multiple skiers with tow ropes of different length
- Always make sure to slowly pull the slack out of the ski rope and wait for the OK from the skier before advancing the throttle to ensure the rope is not wrapped around the skier and that the skier is ready. Never advance the throttle until the skier provides the ready signal.

- When turning around to pick up a fallen skier, make sure to look for other boat traffic in the direction of the turn before you turn the boat.
- Approach a skier in the water from the downwind side and be certain to stop the motion of the boat and your motor before coming in close proximity to the skier.
- Give immediate attention to a fallen skier. A fallen skier is very hard to see by other boats and is extremely vulnerable. When a skier falls, be prepared to immediately turn the boat and return to the skier.
- Never leave a fallen skier alone in the water for any reason and have an observer display a skier down flag to alert other boaters that your skier has fallen.
- Agree on hand signals to be used between the observer and skier to communicate. This is important to eliminate confusion and ensure the safety of your skiers, wakeboarders or tubers. Refer the Hand Signals drawing in this section for signals that are commonly used during water sports activities.
- Make sure the observer watches for the skier's signal to indicate he or she is OK. If the signal is not seen immediately, assume the skier is injured and in need of immediate assistance. Be prepared to respond quickly.
- For additional information on water skiing, including hand signals and water skiing manuals, contact the American Water Skiing Association in Winter Haven, Florida, 813-324-4341.

	WARNING	
<p>MOVING PROPELLERS ARE DANGEROUS. THEY CAN CAUSE DEATH, LOSS OF LIMBS, OR OTHER SEVERE INJURY. DO NOT USE THE SWIM PLATFORM OR SWIM LADDER WHILE THE ENGINE IS RUNNING. STOP THE ENGINE IF DIVERS, SWIMMERS OR SKIERS ARE ATTEMPTING TO BOARD. ALWAYS PROPERLY STORE THE LADDER BEFORE STARTING THE ENGINE.</p>		



2.13 Wake/Teak Surfing

Wake or Teak Surfing is a new and dangerous boating fad that involves an individual holding on to the swim platform of a vessel while a wake builds up then lets go to body surf the wave created by the boat; hence the term- "Wake Surfing." This activity puts that individual directly in the

path of the boat's exhaust and poisonous carbon monoxide. Because of the multiple dangers associated with wake surfing and the carbon monoxide problem in particular, the Coast Guard has issued a safety alert that strongly advises the public not to engage in wake surfing and warns that the activity may cause carbon monoxide poisoning and even fatalities.

Wake surfing not only exposes an individual to potentially fatal concentrations of carbon monoxide from the engine exhaust, it exposes them unnecessarily and dangerously to the boat's propeller. The danger is compounded by the fact that individuals do not usually wear a life jacket when wake surfing.

Wake surfing is an extremely dangerous activity and you should never allow anyone to "Wake Surf" behind your boat or be in the water near the ladder or swim platform while the engine is operating.

	WARNING	
<p>WAKE OR TEAK SURFING (HOLDING ON TO THE SWIM PLATFORM WHILE BOAT IS UNDERWAY) IS EXTREMELY DANGEROUS AND CAN CAUSE SEVERE INJURY OR DEATH. WAKE SURFING PUTS AN INDIVIDUAL DIRECTLY IN THE PATH OF THE BOAT'S EXHAUST AND EXPOSES THEM TO POISONOUS LEVELS OF CARBON MONOXIDE. IT ALSO EXPOSES AN INDIVIDUAL TO THE POSSIBILITY OF BEING THROWN INTO THE PROPELLERS. YOU SHOULD NEVER ALLOW ANYONE TO WAKE SURF BEHIND YOUR BOAT OR TO BE IN THE WATER NEAR THE LADDER OR SWIM PLATFORM WHILE THE ENGINE IS RUNNING.</p>		

2.14 Man Overboard

If someone falls overboard, you must be prepared to react quickly, particularly when you are offshore. The following procedures will help you in recovering a person that has fallen overboard.

- Immediately stop the boat and sound a man overboard alarm and have all passengers point to the person in the water.
- Circle around quickly and throw a cushion or life jacket to the person, if possible, and another to use as a marker.
- Keep the person on the driver side of the boat so you can keep him in sight at all times.
- Make sure to approach the person from the downwind side and maneuver the boat so the propellers are well clear of the person in the water.

- Turn off the engine when the person is alongside and use a ring buoy with a line attached, a paddle or boat hook to assist him to the boat. Make sure you don't hit him with the ring buoy or the boat.
- Pull the person to the boat and assist him on board.
- Check the person for injuries and administer first aid if necessary. If the injuries are serious, call for help. Refer to the Safety Equipment chapter for more information on first aid and requesting emergency medical assistance.

2.15 Trash Disposal

The discharge of plastic trash or trash mixed with plastic is illegal anywhere in the marine environment. U.S. Coast Guard regulations also restrict the dumping of other forms of garbage. Regional, state and local restrictions on garbage discharges also may apply.

Responsible boaters store refuse in bags and dispose of it properly on shore. You should make sure your passengers are aware of the local waste laws and the trash management procedure on your boat. Refer to the placard mounted on your boat for more specific information regarding solid waste disposal.

Federal law requires that vessels of 26 feet or longer must display in a prominent location, a durable placard at least 4 by 9 inches notifying the crew and passengers of the discharge restrictions (Marpol Treaty). A label for this purpose has been shipped with the boat and is attached to the port side of the cockpit. It is the boat owner's responsibility to make sure this placard remains mounted and legible in accordance with the law.

WARNING

MOVING PROPELLERS ARE DANGEROUS. THEY CAN CAUSE DEATH, LOSS OF LIMBS, OR OTHER SEVERE INJURY. DO NOT USE THE SWIM PLATFORM OR SWIM LADDER WHILE THE ENGINE IS RUNNING. STOP THE ENGINE IF DIVERS OR SWIMMERS ARE ATTEMPTING TO BOARD. ALWAYS PROPERLY STORE THE LADDER BEFORE STARTING THE ENGINE.

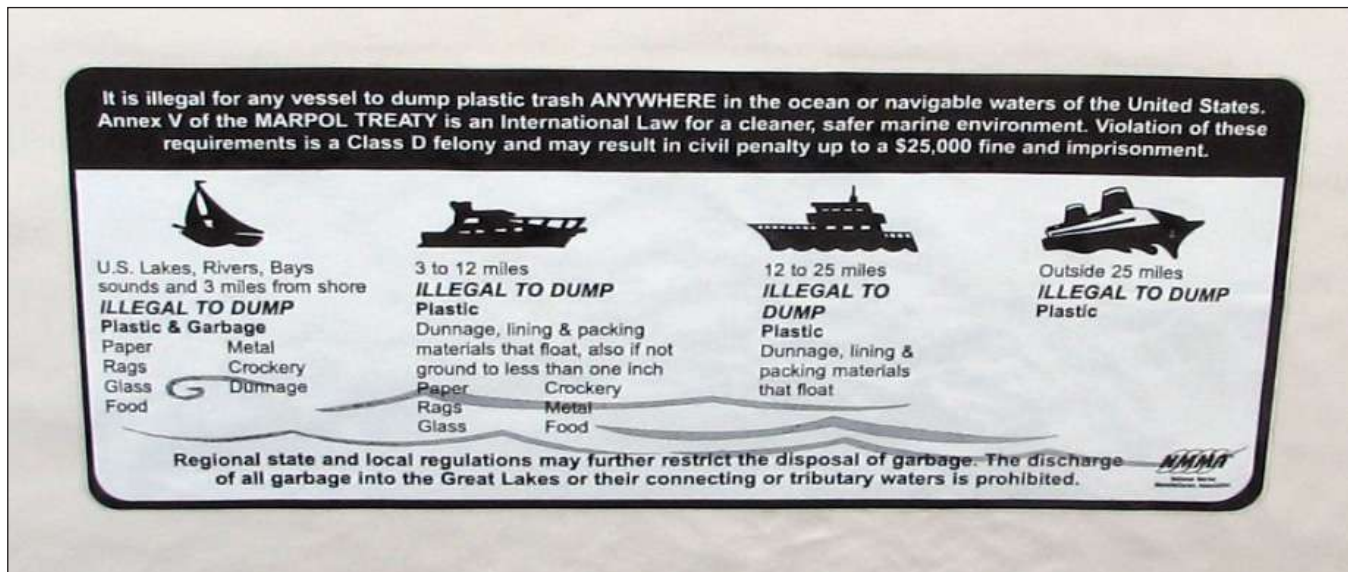

Marpol Treaty Placard - Displayed On In-Floor Storage Compartment Hatch

2.16 Maximum Capacities Plate

Coast Guard rules require boats less than 20 feet (6 meters) to display a gross weight and person-capacity plate provided by the manufacturer.

Boat manufacturers in the National Marine Manufacturers Association (NMMA) program will display a gross weight and person-capacity plate on boats up to 26 feet (7.9 meters).

The person/load capacity is determined by the US Coast Guard. The capacity plate is usually located near the helm in clear view of the operator. The limits indicated on the capacity plate are enforceable by law. Occupant seating charts in Appendix H show the proper seating position for you and your passengers on boats less than 26 feet (7.9 Meters).

You should never exceed the "U.S. Coast Guard Maximum Capacities" indicated on the capacity plate.

Larger boats will display a Yacht Certification plate indicating compliance with the NMMA and U.S. Coast Guard requirements.



Typical 218SS Capacity Plate

Note that the plate shown is for reference purposes only. Always refer to the capacity plate on your boat for actual maximum load capacities and persons.

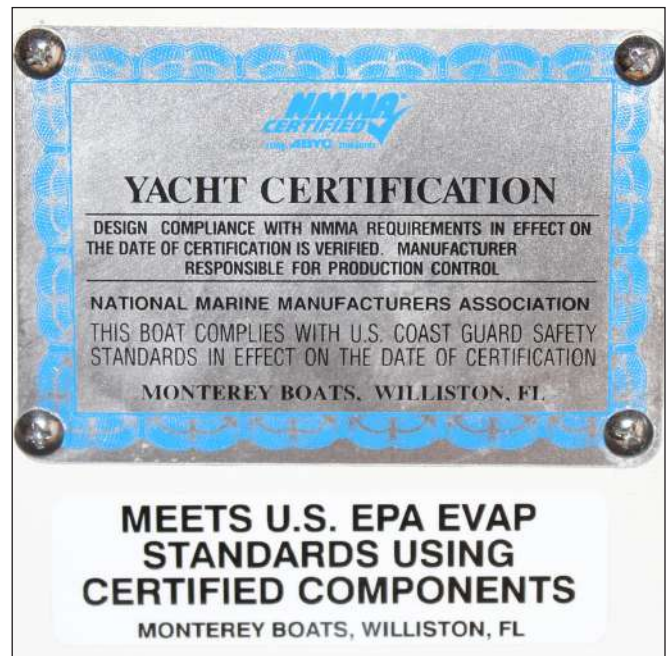

Yacht Certification

2.17 Trailering Your Boat

If you trailer your boat, make sure that your tow vehicle is capable of towing the weight of the trailer, boat and equipment and the weight of the passengers and equipment inside the vehicle. This may require that the tow vehicle be specially equipped with a larger engine, transmission, brakes and trailer tow package.

The boat trailer is an important part of your boating package. The trailer should be matched to your boat's weight and hull. Using a trailer with a capacity too low will be unsafe on the road and cause abnormal wear. A trailer with a capacity too high can damage the boat. Contact your boat or trailer dealer to evaluate your towing vehicle and hitch, and to make sure you have the correct trailer for your boat.

NOTICE:

Your Monterey is a heavy boat and care must be taken when selecting the trailer. We recommend that you use a bunk style trailer that incorporates long bunks running under and parallel to the stringers to support the hull. Large boats should have additional forward bunks on either side of the keel to support the bow.

Avoid using a full roller trailer that does not have bunks. Roller trailers have a tendency to put extreme pressure points on the hull, especially on the lifting strakes, and have damaged boats. The situation is worse during launching and haul out. Damage resulting from improper trailer support or the use of a full roller trailer will not be covered by the Monterey Warranty.

NOTICE:

Contact your boat or trailer dealer to evaluate your towing vehicle and hitch, and to make sure you have the correct trailer for your boat.

- Make sure the trailer is a match for your boat's weight and hull design. More damage can be done to a boat by the stresses of road travel than by normal water operation. A boat hull is designed to be supported evenly by water. So, when it is transported on a trailer it should be supported structurally as evenly across the hull as possible allowing for even distribution of the weight of the hull, engine and equipment.

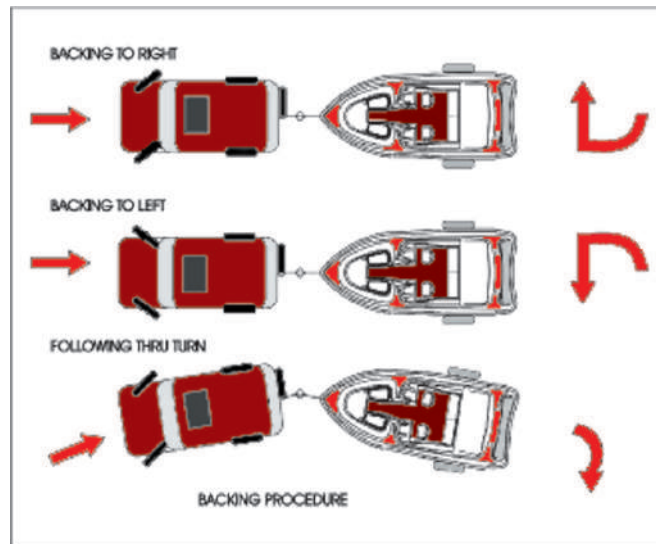

- Make sure the trailer bunks properly support the hull and do not put pressure on the lifting strakes. The bunks must be kept in good condition to prevent scratching and gouging of the hull.
- The capacity rating of the trailer should be greater than the combined weight of the boat, motor, and equipment. The gross vehicle weight rating must be shown on the trailer. Make sure the weight of the boat, engine, gear, fuel and trailer is not more than the gross vehicle weight rating.
- Make sure the boat is securely fastened on the trailer to prevent movement between the boat and trailer. The bow eye on the boat should be secured to the trailer frame with a rope, chain turnbuckle or ratchet strap in addition to the winch cable or strap. Additional straps may be required across the beam of the boat.

NOTICE:

Your boat or trailer dealer will give instructions on how to load, fasten and launch your boat.

CAUTION

BOATS HAVE BEEN DAMAGED BY TRAILERS THAT DO NOT PROPERLY SUPPORT THE HULL. ALWAYS MAKE SURE THE TRAILER BUNKS AND ROLLERS ARE ADJUSTED SO THEY ARE NOT PUTTING EXCESSIVE PRESSURE ON THE LIFTING STRAKES AND ARE PROVIDING ENOUGH SUPPORT FOR THE HULL. HULL DAMAGE RESULTING FROM IMPROPER TRAILER SUPPORT IS NOT COVERED BY THE MONTEREY WARRANTY.

Before Going Out On The Highway:

- Side curtains, clear connector, back drop and aft curtain must be removed when trailering. Canvas enclosures are not designed to withstand the extreme wind pressure encountered while trailering and will be damaged. Always remove and properly store the enclosure before trailering your boat.
- If your boat is equipped with a wakeboard tower or an arch, make sure the arch or wakeboard tower is not too high to go under carports and overhangs when the boat is on your trailer. If necessary lower the arch or tower for trailering.
- Make sure the tow ball and trailer coupler are the same size and bolts and nuts are tightly secured.
- The coupler must be completely over the ball and the latching mechanism locked down.
- Make sure the trailer is loaded evenly from front to rear as well as side to side and has the correct weight on the hitch. Too much weight on the hitch will cause the rear of the tow vehicle to drag and may make steering more difficult. Too little weight on the hitch will cause the rig to fishtail and will make controlling the tow vehicle difficult. Contact your trailer manufacturer or dealer for the correct weight on the hitch for your trailer.

- The safety chains must be attached crisscrossing under the coupler to the frame of the tow vehicle. If the ball was to break, the trailer would follow in a straight line and prevent the coupler from dragging on the road. Make sure the trailer emergency brake cable or chain is also installed to the tow vehicle frame.
- Make sure the lights on the trailer function properly.
- Check the brakes. On a level parking area roll forward and apply the brakes several times at increasing speeds to determine if the brakes on the tow vehicle and trailer are working properly. In most states all trailers with gross vehicle weight of over 1500 LBS (680kg) are required to have brakes.
- Make sure the tow vehicle has side view mirrors that are large enough to provide an unobstructed rear view on both sides of the vehicle.
- Check the tires and wheel bearings.

NOTICE:

Make sure your towing vehicle and trailer are in compliance with all state and local laws. Contact your state motor vehicle bureau for laws governing the towing of trailers.

THIS PAGE WAS LEFT BLANK
INTENTIONALLY

PROPULSION SYSTEM

3.1 General

Your boat is designed to be powered with single or twin inboard engines and outdrive systems. Each manufacturer of the various inboard/outboard drive systems provides an owner's information manual with its product. It is important that you read the manual(s) very carefully and become familiar with the proper care and operation of the engine and drive system. A warranty registration card has been furnished with each new engine and can be located in the engine owner's manual. All information requested on this card should be filled out completely by the dealer and purchaser and then returned to the respective engine manufacturer as soon as possible.



WARNING



CERTAIN MOVING PARTS ARE EXPOSED AND CAN PROVE DANGEROUS TO SOMEONE UNFAMILIAR WITH THE OPERATION AND FUNCTION OF THE EQUIPMENT. DO NOT ATTEMPT TO SERVICE ANY ENGINE OR DRIVE COMPONENT WITHOUT BEING TOTALLY FAMILIAR WITH THE SAFE AND PROPER SERVICE PROCEDURES.

3.2 Drive Systems

The inboard engine is mounted in the stern and coupled to a transom mounted outdrive which does all shifting, steering, and propulsion functions. The outdrive is supplied by the engine manufacturer and has specific lubrication and maintenance requirements. Twin engine boats will be equipped with two engines and two outdrives.

Proper engine alignment is very important. This was done by the factory when the engine was installed and should be checked once per season with Volvo engines and once every three years with Mercruiser engines thereafter. If you experience excessive vibrations or suspect that the engine is out of alignment, please contact your Monterey dealer.

Marine growth and galvanic corrosion is a concern if the boat is to be kept in the water. Marine growth occurs when components are left in the water for extended periods and can cause poor



Typical Mercruiser Gas Engine

performance or permanent damage to the exposed components. The type of growth and how quickly it occurs is relative to the water conditions in your boating area. Water temperature, pollution, current, etc. can have an effect on marine growth. If the boat is to be left in saltwater, the hull and outdrive must be protected with antifouling paint. It is extremely important that the proper antifouling paint is used on each component. Contact your Monterey dealer for information on the proper paint to use in your area.

Galvanic corrosion is the corrosion process occurring when different metals are submerged in an electrolyte. Seawater is an electrolyte and submerged engine components must be properly protected. Outdrives are equipped with sacrificial anodes to prevent galvanic corrosion problems. The anodes must be monitored and replaced as necessary.

On some outdrives, the standard anode may not provide an acceptable level of protection when a drive is used in fresh water and a magnesium anode must be used. A magnesium anode, when used for combined operation in both fresh and saltwater, or water with a low salt content, will deteriorate quicker and must therefore be replaced

more often. For recommendations regarding corrosion protection for the engine or outdrive, please refer to the engine owner's manual.

CAUTION

SOME OUTDRIVES REQUIRE SPECIAL ANODES FOR FRESH WATER AND A DIFFERENT TYPE OF ANODE FOR SALT WATER TO PROTECT THE DRIVE FROM GALVANIC CORROSION. CONTACT THE ENGINE MANUFACTURER OR YOUR MONTEREY DEALER FOR THE PROPER ANODE TO USE IN YOUR BOATING AREA.

CAUTION

MANY ANTI-FOULING PAINTS DESIGNED FOR BOAT HULLS CAN CAUSE SEVERE DAMAGE TO THE OUTDRIVE. DO NOT PAINT THE OUTDRIVE OR ALLOW IT TO COME IN CONTACT WITH ANTI-FOULING PAINTS DESIGNED FOR BOAT HULLS. CONTACT YOUR MONTEREY DEALER OR ENGINE MANUFACTURER FOR INFORMATION ON THE PROPER PAINTING PROCEDURES.



Typical Thru-Hull Exhaust Port

3.3 Engine Exhaust System

Inboard/outboard engines use the exhaust system to expel exhaust gases and cooling water. Engine exhaust exits the rear of the boat through the exhaust system. The system consists of engine exhaust manifolds, exhaust hoses and the outdrive.

A periodic inspection of the coolant hoses, exhaust hoses and related parts should be made to ensure that leaks, heat deterioration or damage has not resulted. Replace them as necessary. Refer to the engine owner's manual for more information on the exhaust system in your boat.

Exhaust Diverter Valves (Optional on some Engines)

Some models can be equipped with an optional exhaust diverter valve system that directs exhaust either through the outdrive and prop or to thru-hull exhaust ports in the hull sides. Valves in each exhaust pipe are opened or closed by electric actuators that are controlled by an Exhaust switch at the helm.

The thru-hull exhaust ports provide added performance and enhanced sound. Using the switch at the helm, the operator can select the aggressive sounding thru-hull mode (Exhaust switch ON) or the quieter thru-prop mode (Exhaust switch OFF).

If this option is installed in your boat, it is important to change the exhaust from thru-prop to



Exhaust System Diverter Valve

thru-hull at least once each time the boat is used. Changing exhaust mode opens and closes the diverter valves which keeps them free and operating properly.

WARNING

DO NOT INHALE EXHAUST FUMES! EXHAUST CONTAINS CARBON MONOXIDE THAT IS COLORLESS AND ODORLESS. CARBON MONOXIDE IS A DANGEROUS GAS THAT IS POTENTIALLY LETHAL.

3.4 Engine Cooling System

All marine engines use surface water as a cooling medium. The cooling water enters the system through a water intake in the outdrive and is expelled through the exhaust system. Water is pumped through the water inlets, circulated through the engine block or heat exchanger, and relinquished with the exhaust gases through the outdrive or thru-hull exhaust system.

The water pump uses a small impeller made of synthetic rubber. The impeller and water pump cannot run dry for more than a few seconds.



CAUTION



RUNNING THE ENGINE WITHOUT WATER FLOWING TO THE WATER PUMP CAN CAUSE SERIOUS DAMAGE TO THE WATER PUMP IMPELLER OR ENGINE. NEVER RUN THE MOTOR WITHOUT WATER FLOWING TO THE WATER PUMP.

NOTICE:

If the boat is used in salt or badly polluted water, engines without fresh water cooling should be flushed after each use. Refer to the engine owner's manual for the proper engine flushing procedure.

Fresh Water Cooling (Optional on some engines)

Your boat could be equipped with a fresh water cooling system. Installation of a "Fresh Water" or Closed" cooling system that is cooled by a heat exchanger and the seawater cooling system provides adequate engine cooling without exposing the internal engine cooling system to the harmful effects of surface water. This system is optional with the gasoline engine on your boat. The engine owner's manual provides additional information regarding service and maintenance of this equipment.



CAUTION



A RUPTURED COOLING OR EXHAUST HOSE CAN CAUSE SEVERE ENGINE DAMAGE OR ALLOW A LARGE AMOUNT OF WATER TO FLOW INTO THE BILGE. SHOULD AN ENGINE INTAKE, EXHAUST OR COOLING HOSE RUPTURE, TURN THE ENGINE OFF IMMEDIATELY. PROCEED UNDER TOW IF NECESSARY, TO A SERVICE FACILITY FOR APPROPRIATE REPAIRS. MAINTAIN A CLOSE VISUAL WATCH ON THE PROBLEM HOSE AND THE BILGE WATER LEVEL.



Typical Mercruiser Bravo III Propellers



Volvo DP Propellers

3.5 Propellers

Outdrives can be equipped with a single propeller or dual, counter rotating propellers that convert the engine's power into thrust, depending on engine and outdrive selected for your boat. Propellers come in a variety of styles, diameters and pitches. Pitch is the theoretical distance traveled by the propeller in each revolution.

The propeller(s) that will best suit the normal needs of your boat will depend somewhat on your application and expected average load. Propeller sizes are identified by a number or code stamped on the prop. Always repair or replace a propeller immediately if it has been damaged. A damaged and therefore out of balance propeller can cause vibration that can be felt in the boat and could damage the outdrive gear assembly.

Please refer to the outdrive owner's manual for specific information on propellers and the proper installation procedure.

3.6 Performance Issues and Propellers

It is extremely important that the boat is propped to run at or very near the recommended top RPM with an average load. If the top RPM is above or below the recommended range, the propeller(s) must be changed to prevent loss of performance and possible engine damage.

The engine can be damaged and the warranty voided if the boat is not propped correctly. Always consult your Monterey or authorized engine service dealer when making changes to the propeller(s) or if the boat does not run near the top recommended RPM.

Your boat was shipped with a propeller or propellers that typically provide optimum performance for your boat. However there are factors that can affect performance and propeller requirements.

NOTICE:

Before changing propellers to correct boat performance problems, be sure other factors such as engine tuning, bottom and running gear growth, etc. are not the source of performance changes. Always be sure the load conditions are those normally experienced before changing propellers.

- The addition of heavy equipment like excessive gear, additional coolers, etc., will cause additional load on the engine. Consequently, a different propeller or propellers may be required.
- If the boat ran in the required RPM range when it was new and you have not added any additional gear or heavy equipment and have not damaged a propeller, there is a good chance the propeller or propellers are not the problem.
- Boats operated at high altitudes (above 2000 feet). Engines operated at high altitudes will not be able to develop as much horse power as they do at or near sea level. Consequently, a different propeller or propellers may be required.



288SS Instrument Panel

3.7 Helm and Engine Instrumentation

The helm station is equipped with a set of engine instruments and/or alarms. These instruments allow the operator to monitor the engine operational conditions. Close observation of these instruments allows the operator to operate the engine at the most efficient level and could save the engine from serious costly damage. The instrumentation is unique to the boat model and type of engine installed in your boat.

Some or all of the following gauges and instruments may be present.

Tachometer

The tachometer displays the speed of the engine in revolutions per minute (RPM). This speed is not the boat speed nor necessarily the speed of the propeller(s). The tachometer may not register zero with the key in the "OFF" position.

Most tachometers have an LCD screen that digitally displays data for specific engine systems and for functions of some optional equipment. Keys on each side of the display allow the operator to scroll through the available data monitored by the display. The functions monitored will vary depending on the engine model and other optional equipment installed on your boat.

Tachometer features are unique to the tachometer and engine or engines installed in your boat. A quick reference guide that provides information and instructions for most tachometer and engine applications used in sport boat models is located in Appendix F.

Contact your dealer if you need assistance with the operation and features for the tachometer in your boat.



Digital LED Display Screen In Tachometer

Some or all of the following data could be available on the tachometer LCD display:

- Time of day
- Total engine hours
- Engine speed (RPM)
- Vessel speed
- Oil pressure
- Engine coolant temperature
- Engine water pressure
- Battery voltage
- Fuel level in tank
- Fuel consumption
- Outdrive trim position
- Outdrive steering position
- Depth
- Air temperature
- Water temperature
- Compass heading



Speedometer

NOTICE:

On some tachometers, Mercury engines broadcast a "SERVICE ENGINE SOON" message on the digital display when the ignition is turned to the "ON" position. This message is required as part of the EPA emissions check routines. This is normal operation for Mercury engines and does not indicate a problem with the tachometer. Volvo engines do not display this message on the tachometer because this function is covered by the Volvo 2.5" display. Contact your dealer for additional information on tachometer or other digital displays and messages.

CAUTION

MAINTAINING MAXIMUM, OR CLOSE TO MAXIMUM RPM FOR EXTENDED PERIODS CAN REDUCE THE LIFE OF THE ENGINE. NEVER EXCEED THE MAXIMUM RECOMMENDED OPERATION RPM OF THE ENGINE.

Speedometer

The speedometer indicates the speed of the boat in miles per hour. Most speedometers measure the water pressure against a small hole in a pickup tube located in the engine lower unit or mounted on the bottom of the transom.

Temperature Gauge

The temperature gauge indicates the temperature of the engine cooling system. A sudden increase in the temperature could signal a blocked cooling passage or a water pump malfunction

CAUTION

CONTINUED OPERATION OF AN OVERHEATED ENGINE CAN RESULT IN ENGINE SEIZURE. IF AN UNUSUALLY HIGH TEMPERATURE READING OCCURS, SHUT THE ENGINE OFF IMMEDIATELY. THEN INVESTIGATE AND CORRECT THE PROBLEM.

Oil Pressure Gauge

The oil pressure gauge monitors the engine lubrication system pressure. The oil pressure indicated when the engine is new is usually the reference for normal oil pressure for that engine. A drop in oil pressure is a possible indication of oil pump problems, a leak or fuel diluted oil.

Fuel Gauge

The fuel gauge indicates the amount of fuel in the fuel tank. This gauge is merely a relative indication of the available fuel supply and not a calibrated instrument.

Voltmeter

The voltmeter displays the voltage for the battery and the charging system. The normal voltage is 11 to 12.5 volts with the engine off, and 13 to 14.5 volts with the engine running.

Hour Meter

The hour meter keeps a record of the operating time for the engine. The hour meter is normally located in the tachometer.

Tilt/Trim Gauge

The tilt/trim gauge monitors the position of the outdrive. The upper range of the gauge indicates the tilt, which is used for trailering and shallow water operation. The lower range indicates the trim position. This is the range used to adjust the hull angle while operating your boat on plane. Please refer to Chapter 2 and the engine owner's manual for more information on the operation of the outdrive power tilt and trim.



Typical Backlit Multi Gauge
Fuel Level, Engine Temperature, Voltage & Oil Pressure



Tilt/Trim Gauge

Depth Gauge (Optional 218SS and 238SS)

The Depth gauge indicates the depth of the water below the bottom of the boat. The gauge is equipped with a shallow water alarm. The alarm will sound at a depth preset by the operator.

Fuel Management (Optional)

Fuel management systems are optional and could be installed on your boat as part of the engine monitoring system. On most engines, the fuel management gauge is built into the tachometer digital display and can monitor miles per gallon, total gallons used and total gallons remaining.

If you have a fuel management system installed on your boat, please refer to the engine or fuel management manual for information on that system.

Engine Alarm

Inboard engines are equipped with an audible alarm system mounted in the helm area that monitors selected critical engine systems. The alarm will sound if one of these systems begins to fail. Refer to the engine owner's manual for information on the alarms installed with your engine.

If an engine alarm sounds, immediately shut off the engine, if safe to do so, until the problem is found and corrected.

Compass

The compass is on top of the console. To adjust the compass for your area, read the instructions on "Compass Compensation" given to you in the literature packet. The compass cannot be adjusted accurately at the factory because it must be compensated for the influence of the electrical equipment and electronics unique to your boat. Therefore, the compass should be adjusted by a professional after the electronics are installed and before operating the boat.

Instrument Maintenance

Electrical protection for the engine instruments and ignition circuitry is provided by circuit breakers located on the engine. The navigational electronics are protected by the electronics breaker in helm breaker panel. The ignition switch and



Depth Gauge



Typical Compass

instrument wire connectors should be sprayed periodically with a contact cleaner/lubricant. The ignition switch and all instruments, controls, etc. should be protected from the weather when not in use. Excessive exposure can lead to gauge and ignition switch difficulties.

HELM CONTROL SYSTEMS

4.1 General

The helm controls consist of three systems: the engine throttle and shift controls, the steering system, and the trim tab control switches. These systems provide the operator with the ability to control the direction and attitude of the boat from the helm station.

Each manufacturer of the control components provides an owner's manual with its product. It is important that you read the manuals and become familiar with the proper care and operation of the control systems.

4.2 Engine Throttle and Shift Controls

The shift and throttle controls on your boat may vary depending on the engine and options selected. The following description is typical of most cable and electronic inboard/outboard remote controls. Refer to the engine or control manual for specific information on the controls installed on your Boat.

Single Engine Cable Engine Controls

Cable engine throttle and shift control systems consists of three major components: the control handle, the throttle cable, and the shift cable. The cables are all the push-pull type. Two cables are required for each engine and control. One connects the remote throttle control to the engine and the other connects the remote shift control to the outdrive shift linkage.

The helm on single engine boats is designed for a side mount control with a single lever that operates as a gear shift and a throttle. General operation will include a position for neutral (straight up and down), a forward position (the 1st detent forward of neutral), and a reverse position (the 1st detent aft of neutral). Advancing the control lever beyond the shift range advances the throttle in forward or reverse. Each control is equipped with a means of permitting the engine to be operated at a higher than idle RPM while in neutral for cold starting and warm-up purposes.



Mercruiser Side Mount Cable Control & Stop Switch

Single Engine Electronic Engine Controls

Electronic engine controls are optional on most single engine boats. The shift and throttle control features may vary depending on the engine used. The following control description is typical of most side mount electronic control installations.

The helm is designed for a side mount control with a single lever that operates as a gear shift and a throttle. The electronic control system consists of three major components: the electronic control head, the control processors and applicable harnesses. Controls are completely electronic and there are no cables.

Movement of the control handle sends a signal to the control processor in the engine compartment that operates the engine throttle and shift control servos. General operation will include a position for neutral (straight up and down or slightly aft of vertical), a forward position (the 1st detent forward of neutral), and a reverse position (the 1st detent aft of neutral). Advancing the control lever beyond the shift range advances the throttle in forward or reverse. Each control is equipped with a means of permitting the engine to be operated at a higher than idle RPM while in neutral for cold starting and warm-up purposes. The control lever is equipped with adjustable control head detent and friction settings.

Switches built into the control or control handle are used by the operator to select available features. The most common features activated by control switches are:

- Starter lockout, which prevents the engine from being started in gear.
- Gear lockout (throttle only), which allows the engine RPM to be advanced in neutral safely.
- Engine Start/Stop button that can be used to start or stop the engine.
- Battery voltage warning indicator that warns the operator of high or low voltage supplied to the system (audible alarm)

These features and others not mentioned require specific procedures to activate and operate them properly. Some of the procedures and features are unique to the engine, drive system and other options installed on your boat. ***It is essential that you read the owner's manual for the control system and be completely familiar with its operation before using your boat.***



CAUTION



ALWAYS RETURN THE ENGINE THROTTLE LEVER TO THE EXTREME LOW SPEED POSITION BEFORE SHIFTING. NEVER SHIFT THE UNIT WHILE ENGINE SPEED IS ABOVE IDLE RPM.



Mercruiser Single Engine Electronic Control

Twin Engine Electronic Engine Controls

Mercury DTS and Volvo EVC models are equipped with electronic engine controls as standard on 328SS twin engine boats. The shift and throttle control features may vary depending on the engine options selected. The following control description is typical of most electronic control installations.

The helm is designed for a binnacle style control with a single lever for each engine. The electronic control system consists of three major components: the electronic control head with integrated or separate keypad, the control processors and applicable harnesses. Most controls are completely electronic and have no cables.

Movement of the helm control arm sends a signal to the control processor, located in the engine compartment that operates the engine throttle and transmission control servos. The controls have a single lever for each engine that operates as a gearshift and a throttle. General operation will include a position for neutral (straight up and down or slightly aft of vertical), a forward position (the 1st detent forward of neutral), and a reverse position (the 1st detent aft of neutral). Advancing the control lever beyond the shift range advances the throttle in forward or reverse. Each control is equipped with a means of permitting the engine to be operated at a higher than idle RPM while in neutral for cold starting and warm-up purposes. The control levers are equipped with adjustable control head detent and friction settings.



The control head key pad has integrated switches and indicator lights which allow the operator to control all aspects of the boat's propulsion system. The most common features activated or monitored by the keypad are:

- Starter lockout, which prevents the engine from being started in gear.
- Gear lockout, which allows the engine RPM to be advanced in neutral safely.
- Low speed or docking mode that reduces engine speed and power surge for more controlled maneuvering in tight quarters and while docking.
- Battery voltage warning indicator that warns the operator of high or low voltage supplied to the system (audible alarm)
- An engine synchronization feature that automatically keeps both engines at the same RPM. Refer to Engine Synchronizing in this section for more information regarding engine synchronization.

These features and others not mentioned require specific procedures to activate and operate them properly. Some of the procedures and features are unique to the engines, drive system and other options installed on your boat. **It is essential that you read the owner's manual for the controls and be completely familiar with their operation before using your boat.**



Mer cruiser Twin Engine Electronic Controls

	CAUTION	
ALWAYS RETURN THE ENGINE THROTTLE LEVERS TO THE EXTREME LOW SPEED POSITION BEFORE SHIFTING. NEVER SHIFT THE UNIT WHILE ENGINE SPEED IS ABOVE IDLE RPM.		

Engine Synchronizing

During most operations of a twin engine boat, it is advantageous for both engines to be operated at the same RPM. This reduces noise and vibration and can increase engine efficiency. Setting the throttles so that the engines are running the same RPM (synchronized) can be done by listening to the engine sounds or with the synchronizer feature built into the electronic engine controls. Attempting to synchronize the engines solely by using the tachometer readings or control lever placement generally will not work. When the engines are in proper synchronization, the throttle levers may not necessarily be even. Refer to the engine or control owner's manual for more information on the using the engine synchronizer feature of your control system.

4.3 Engine Stop Switch

Most boats are equipped with an engine stop switch and lanyard at the helm. When the lanyard is pulled it will engage the switch and shut off the engines. We strongly recommend that the lanyard be attached to the driver whenever the engines are running. If the engine will not start, it could be because the lanyard is not properly inserted into the engine stop switch. Always make sure the lanyard is properly attached to the engine stop switch before attempting to start the engines.

Refer to the engine owner's manual for more information on the engine stop switch.

4.4 Neutral Safety Switch

Every control system has a neutral safety switch. This device prohibits the engine from being started while the control lever is in any position other than the neutral position. If the engine will not start, slight movement of the control lever may be necessary to locate the neutral position and disengage the safety cutout switch. Control system adjustments may be required to correct this condition, should it persist. See your Monterey dealer for necessary control and cable adjustments.

Neutral safety switches should be tested periodically to ensure that they are operating properly. To test the neutral safety switch, make sure the outdrive(s) are tilted down and move the control lever(s) to the forward position with the engines off. **Make sure the control levers and throttles are set to the idle position.** Activate the starter switch just long enough to briefly engage the starter. **Do not hold the starter switch in the start position long enough to start the engine.**

NOTICE

Mercury DTS and Volvo EVC systems are equipped with a computer controlled start feature that will keep the starter engaged until the engine starts if the neutral safety switch fails and allows the starter to engage.

The starter should not engage. Repeat this test with the control levers in reverse and the engine throttles at idle. Again, the starter should not engage. If the starter engages with the control levers in any position other than the neutral position, then the neutral safety switch is not functioning properly and you should contact your dealer and have the neutral safety switch repaired by a



Mercruiser Control Emergency Stop Switch & Lanyard

qualified technician before using your boat. If the engine starts in gear during this test, immediately move the control levers to the neutral position and turn the engine(s) off.



WARNING



IN SOME SITUATIONS, IT MAY BE POSSIBLE TO ACCIDENTALLY START THE ENGINE IN GEAR WITH THE THROTTLE ABOVE IDLE IF THE NEUTRAL SAFETY SWITCH IS NOT OPERATING PROPERLY. THIS WILL CAUSE THE BOAT TO ACCELERATE UNEXPECTEDLY IN FORWARD OR REVERSE AND COULD RESULT IN LOSS OF CONTROL, DAMAGE TO THE BOAT, OR INJURY TO PASSENGERS. ALWAYS TEST THE NEUTRAL SAFETY SWITCH PERIODICALLY AND CORRECT ANY PROBLEMS BEFORE USING THE BOAT.

4.5 Outdrive Power Tilt and Trim

All inboard/outboard drive systems have a tilt and trim feature for the outdrives. This allows the operator to control the position of each outdrive from the helm. Moving the outdrive closer to the boat transom is called trimming "in" or "down." Moving the outdrive further away from the boat transom is called trimming "out" or "up." In most cases, the boat will run best with the drive unit adjusted so the hull runs at a 3 to 5 degree angle to the water.

Typically, a switch or switches on the control lever grip activates the tilt/trim. On twin engine boats, there is typically three switches. One switch that activates both outdrives simultaneously on the port control lever and two switches, one for each outdrive, that activates each tilt/trim individually. The individual tilt/trim switches are usually located either on the port control lever or on a keypad on the control housing.

The term "trim" generally refers to the adjustment of the outdrive within the first 20° range of travel. This is the range used while operating your boat on plane. The term "tilt" is generally used when referring to adjusting the outdrive further up for shallow water operation or trailering. For information on the proper use and maintenance of the power tilt and trim, please refer to the engine owner's manual.

The maximum trim angle for the outdrives is preset at the factory. If necessary, the maximum trim angle can be adjusted by your Monterey dealer.



Mercuriser Single Engine Tilt/Trim Switch

⚠ WARNING ⚠

EXCESSIVE TRIM FOR THE OPERATING CONDITIONS, EITHER TRIM UP OR DOWN, CAN CAUSE BOAT INSTABILITY, PROPELLER CAVITATION, OR MAKE STEERING THE BOAT MORE DIFFICULT. IF THE BOAT BEGINS TO FEEL UNSTABLE OR IS HARD TO STEER, SLOW DOWN AND ADJUST THE TRIM ANGLE.



Mercuriser Twin Engine Tilt/Trim Switches

4.6 Steering System

Your Monterey is equipped with power assisted cable or full hydraulic power steering, depending on the model and selected options. All steering systems are equipped with a tilt steering wheel at the helm. The steering wheel can be tilted to five different positions by activating the tilt lock lever located on the bottom side of the steering wheel mounting bezel. When the lever is released, it automatically locks the steering wheel at or close to the selected angle.

Single Engine Hydraulic Assist Steering

Power assisted cable steering is standard equipment on single engine boats powered by Mercruiser and Volvo engines. Turning the steering wheel moves the gears in the helm, pushing or pulling the cable assembly and turning the outdrive. An engine driven hydraulic power steering pump and cylinder assist the cable steering, which reduces the effort required to turn the boat.

An oil reservoir near the engine hydraulic pump allows for easy system fluid check and fill. It is important that the fluid level in the reservoir be checked frequently and maintained at or near the maximum level. Only use hydraulic fluid recommended by the engine manufacturer.

Refer to the engine manufacturer owner's manuals for specific information on the operation and maintenance for the steering system.

Twin Engine Hydraulic Assist Steering

Boats powered with twin engines and no joystick control are equipped with a power assisted, cable steering system that uses a hydraulic pump driven by one of the engines to provide the "POWER" for the power steering system. Turning the steering wheel moves the gears in the helm, pushing or pulling the cable assembly and turning the outdrives. An engine driven power hydraulic steering pump and cylinder assist the cable steering and reduces the effort required to turn the boat.

An oil reservoir near the engine hydraulic pump allows for easy system fluid check and fill. It is important that the fluid level in the reservoir be checked frequently and maintained at or near the maximum level. Only use hydraulic fluid recommended by the engine manufacturer.

The outdrives are coupled together at the tiller arms by a tie bar. Mercruiser drives are typically



Tilt Steering Wheel & Tilt Release Lever

set parallel and Volvo drives are toed in 1/2" at the aft end of the cavitation plates to provide maximum stability on straight ahead runs and proper tracking through corners. Outdrive or steering system damage may require the outdrives to be realigned.

NOTICE:

If your boat is equipped with hydraulic steering and the joystick option, the outdrives will be independent and not coupled together with a tie bar.

Refer to the engine and steering system manufacturer owner's manuals for specific information on the operation and maintenance for the steering system.

Twin Engine Electronic Steering

Twin engine boats equipped with the joystick control option are equipped with an electronic steering system that provides precise and responsive steering. The system is 100% electronic and there are no mechanical connections between the steering wheel and the drives. Each drive unit is turned independently allowing improved tight quarter maneuvering and the convenience of an optional Joystick control at the helm.

For safety and improved tight quarter maneuvering, the controlling software on most systems senses engine speed and adjusts maximum steering angle and steering wheel resistance to preset limits as the engine speed increases or decreases. The steering angles and steering wheel resistance at specific engine speeds are programmed into the system at the factory and are not adjustable.

The steering on each drive is totally independent with full redundancy built into the system. If the steering fails on one drive unit, the other will continue to operate. Should a failure in one steering system occur, the controlling software will sense the failure and limit the engine RPM as a safety precaution.

Refer to the engine manufacturer owner's manuals for specific information on the operation and maintenance for the steering system installed in your boat.

4.7 Joystick Controls

A joystick control system is an option on most twin engine boats. The joystick can only be used at slow speeds and is engaged by moving the shift and throttle controls to the neutral position and pressing the ON/OFF button on the base of the joystick control or the keypad on the main engine controls. Once activated, the boat moves in the direction the joystick is pushed with the engine speed increasing the further the stick is pushed, up to preset limits. Turning the knob on the top of the joystick rotates the boat in the direction the knob is turned. Another button on the joystick or engine control key pad raises the preset engine speed for maneuvering in high winds and/or strong tides.



Typical Mercruiser DTS Joystick Control

When the joystick is released, it automatically returns to center, the drives shift to neutral, rotate to the straight ahead position, and the engine speed is reduce to idle. It is deactivated by pressing the ON/OFF button at the base of the joystick or control keypad or by moving the shift and throttle control levers.

Joystick control systems are 100% electronic. **Always refer to the engine manufacturer owner's manuals for specific information on the operation and maintenance for the joystick and steering control systems on your boat.**

4.8 Trim Tabs

Trim tabs are optional on the 268SS and standard equipment on 288SS and 328SS models. Trim tabs are mounted to the hull on the transom below the swim platform. Dual rocker switches in the helm are used to control the trim tabs. The switches are labeled and control bow up and down movements. They also control starboard and port up and down movements. Bow up and bow down will control the hull planing attitude, while port and starboard up and down provides control for hull listing.

An indicator next to each switch displays the position of your trim tabs. The display indicates trim tab deflection. When the indicator is at the bottom of the display, the tabs are in the "full-up" (bow up) position. When the indicator is at or near the top of the display, the tabs are fully extended (bow down).

The trim tabs are programmed to automatically retract when the engines are shutdown to keep the actuators clean and set the tabs in the full "UP" position when leaving the dock. Refer to the trim tab operating manual for more information on the operation and programming of the trim tabs.

Before leaving the dock, make sure that the tabs are in the full "UP" position. If they are not, press and hold the control in the bow up position for ten (10) seconds to fully retract the tabs.

NOTICE:

The trim tabs can be damaged by boat trailers if the bunks extend beyond the transom or the boat is not centered properly. They can also be damaged by fork lifts at dry stack marinas during lifting. To reduce the possibility of damage, always make sure the tabs are in the full up position before loading your boat on a trailer or having it lifted by a fork lift.

Trim Tab Operation

Always establish the intended heading and cruise speed before attempting to adjust the hull attitude with the trim tabs. After stabilizing speed and direction, move the trim tabs to achieve a level side to side running attitude being careful not to over trim.

After depressing a trim tab switch, always wait a few seconds for the change in the trim plane to take effect. Avoid depressing the switch while awaiting the trim plane reaction. By the time the effect is



288SS Trim Tab Plane



Trim Tab Control Switch

noticeable the trim tab plane will have moved too far and thus the boat will be in an overcompensated position.

When running at a speed that will result in the boat falling off plane, lowering the tabs slightly, bow down, will improve the running angle and operating efficiency. Positioning trim tabs too far in the down position can reduce operating efficiency and cause substantial steering and handling difficulties.

Be extremely careful when operating in a following sea. The effect of trim tabs is amplified under such conditions. Steering and handling difficulties can result from improper trim tab usage, particularly in a following sea. Always raise the tabs to the full bow up position in these conditions.

When running at high speeds be sure that the tabs are in the full "UP" position. Only enough trim plane action should be used to compensate for any listing. Trim tabs are extremely sensitive at high speeds. Adjust for this and be prepared to slow down if difficulties arise.

When running into a chop, a slight bow down attitude will improve the ride. Be careful not to over trim. Handling difficulties may result.

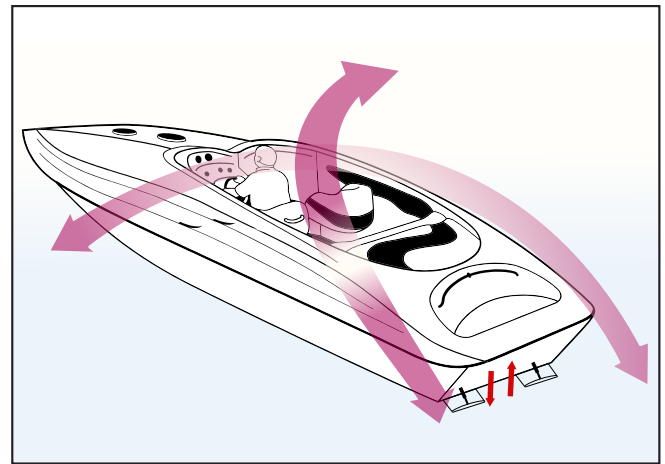

Trim Tabs Control Port & Starboard Listing

4.9 Control Systems Maintenance

Cable Engine Control Maintenance

Periodic inspection of the control systems and all connections should be made. Signs of rust, corrosion, wear, or other deterioration should be serviced immediately. Generally, periodic lubrication of all moving parts and connections with a light waterproof grease is in order.

Lubrication should be performed as often as necessary to keep the system operating smoothly. Control system adjustments may become necessary. If adjustment becomes necessary, see your Monterey dealer.

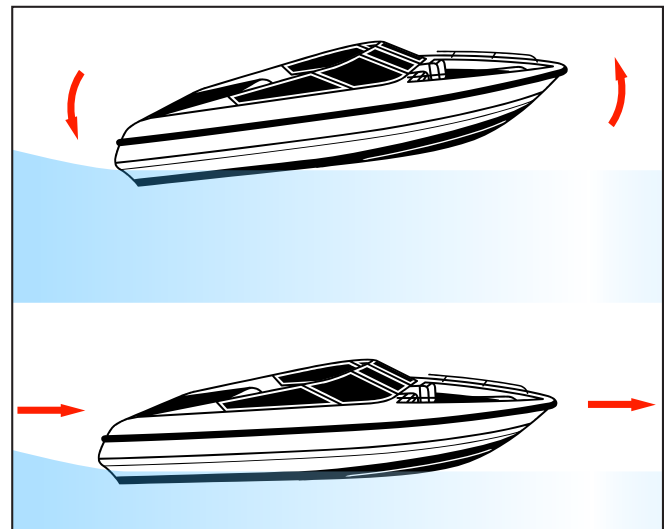

Trim Tabs Control Bow Up & Bow Down

	WARNING	
<p>IMPROPERLY ADJUSTED ENGINE CONTROLS CAN CAUSE LOSS OF CONTROL AND SEVERE ENGINE OR OUTDRIVE DAMAGE. DO NOT ATTEMPT CONTROL SYSTEM ADJUSTMENTS UNLESS YOU ARE FAMILIAR WITH CONTROL SYSTEM SERVICING PROCEDURES.</p>		

Hydraulic and Power Assisted Steering System Maintenance

A periodic inspection of all steering hoses, linkage and helm assemblies should be made. Signs of corrosion, cracking, loosening of fastenings, leaking fluid, excessive wear, or deterioration should be corrected immediately. The transom area in the engine compartment should be checked for leakage around outdrives and for wires, hoses and cables that may be rubbing against the steering cylinder or tiller arm.

You also should make sure there are no wires or cables secured to the steering cable near the power steering cylinder on boats with power assisted steering. The cable is attached to the power steering cylinder control valve and must be free to move slightly to activate the valve. Hard or erratic steering is an indication that the steering cable is not moving freely.

Generally, periodic lubrication of all moving parts and connections with a light waterproof grease is in order. Failure to do so could lead to steering system failure that would result in loss of control.

Engine driven power steering system has specific fluid and maintenance requirements. The fluid level and belt tension should be checked frequently.

Refer to the engine manufacturer's owner's manual for fluid specifications and maintenance instructions for hydraulic assisted steering systems.

Electronic Steering and Control Systems Maintenance

Electronic steering and control systems are supplied by the engine manufacturer. The systems have maintenance requirements that are specific to the engines, drive units and control options installed in your boat.

You should refer to the engine and controls systems owner's manuals for information and maintenance on the control and steering system installed in your boat. Their recommendations should be followed exactly.

The engine controls and steering systems are fully electronic and activated by micro processors and controlling software in each drive unit. If adjustment becomes necessary do not attempt to address the problem yourself. You should contact your Monterey dealer or Monterey Customer Service for assistance.



Trim Tab Plane & Anode



WARNING



IMPROPERLY ADJUSTED ELECTRONIC ENGINE CONTROLS CAN CAUSE LOSS OF CONTROL AND SEVERE ENGINE OR DRIVE DAMAGE. IF YOUR CONTROLS ARE NOT OPERATING PROPERLY, DO NOT ATTEMPT CONTROL SYSTEM ADJUSTMENTS YOURSELF. CONTACT YOUR DEALER OR MONTEREY CUSTOMER SERVICE FOR ASSISTANCE AND DO NOT USE THE BOAT UNTIL THE SITUATION IS CORRECTED.

Outdrive Lubrication

Please refer to the engine owner's manual for maintenance and lubrication instructions for the outdrive.

Trim Tab Maintenance

The trim tab actuators are electric and require no routine maintenance except to periodically inspect the tab actuators for corrosion or marine growth and test the system to ensure that it is operating properly.

Marine growth can interfere with the proper operation of the trim tab planes and actuators. To reduce problems due to marine growth, always return the trim tabs to the full "UP" position after operating the boat and periodically inspect and clean marine growth from the actuators and planes.

If the boat is kept in the water, the trim tabs must be equipped with a zinc anode to prevent galvanic corrosion. Galvanic corrosion is the corrosion process occurring when different metals are submerged in an electrolyte. Seawater is an electrolyte and submerged metal components must be properly protected. The anodes will need to be changed when they are 75% of their original size. Refer to the Routine Maintenance chapter of this manual for information on maintaining zinc anodes.

To discourage any marine growth on tabs or actuators, antifouling paint can be applied. When applying paint to the actuators, make sure it is fully retracted. **Do not paint the stainless ram above the area that is exposed when retracted. The bottom paint will damage the O-ring seals when the ram is retracted and allow seawater to enter the actuator motor. Also don't paint the zinc anode.** Contact your dealer or the trim tab manufacturer for information regarding the correct bottom paint for the trim tabs.

Refer to the trim tab owner's manual for additional maintenance information, specifications, troubleshooting and operating instructions.

FUEL SYSTEM

5.1 General

The gasoline fuel system used in Monterey boats sold in the United States is designed to meet or exceed the emission control standards of the Environmental Protection Agency (EPA) and the requirements of the U.S. Coast Guard, the Boating Industry Association and the American Boat and Yacht Council in effect at the time of manufacture.

Boats sold internationally (all countries other than the United States) are equipped with fuel systems that are not equipped with U.S. EPA required emission controls but do meet or exceed the requirements of the U.S. Coast Guard, the Boating Industry Association and the American Boat and Yacht Council in effect at the time of manufacture.

All gasoline fuel systems have been factory inspected and pressure tested in accordance with regulations in effect at the time of manufacture. This inspection assures that the system is air tight, leak proof and safe. It is the responsibility of the purchaser to maintain it in that condition. Make frequent inspections to assure that no deterioration or loosening of connections is resulting from vibration.



DANGER



DO NOT LET THE ODOR OF GASOLINE GO UNCHECKED. ANY ODOR OF GASOLINE MUST BE IMMEDIATELY INVESTIGATED AND STEPS TAKEN TO PROTECT THE BOAT AND ITS OCCUPANTS UNTIL THE PROBLEM IS CORRECTED. IF THE ODOR OF GASOLINE IS NOTICED, SHUT OFF ALL ENGINE AND ELECTRICAL EQUIPMENT. INVESTIGATE AND CORRECT THE SITUATION IMMEDIATELY. HAVE ALL PASSENGERS PUT ON PERSONAL FLOTATION DEVICES AND KEEP A FIRE EXTINGUISHER READY UNTIL THE SITUATION IS RESOLVED.

Fuel Withdrawal Tube

The fuel withdrawal tubes are positioned in the fuel tank to achieve optimum fuel usage, fuel line routing, etc. At certain speeds and hull trim angles, the fuel supply at the withdrawal tank location can increase or decrease accordingly. Be extremely careful when attempting to operate the boat when low on fuel. Though some fuel may be in the tank, the relative trim angle of the boat may cause the fuel to flow away from the withdrawal.



Typical Keyless Fuel Fill

Fuel Gauge

This indicates the amount of fuel in the tank. Due to the mechanical nature of the fuel sender and fuel tank shapes, variations in readings during various speeds of operation may occur. This system is merely a relative indication of the available fuel supply and not a calibrated instrument.

Fuel Fill and Vent System - U.S. Fuel Systems

In order to comply with U.S. EPA emission regulations, boats sold in the United States are equipped with special fuel systems that do not vent directly to the atmosphere. The system is equipped with a "keyless" fuel cap located on the port gunnel that is marked "GAS." The fill cap is not vented and the fill system is completely sealed when the cap is closed.

There is a fuel tank vent built into the fuel fill. Another vent equipped with vapor emission control components in the hull side provides ventilation for the tank when the fuel fill system is sealed. While the tank is being filled, most air displaced by the fuel escapes through the fuel fill vent. The fuel fill and vent system are designed such that an automatic shutoff valve in the marina fuel pump will stop the flow before fuel can be ejected into the vent system when the tank is full. You should never attempt to "top off" the tank after the pump

shutoff valve has activated. This could force fuel into the vent system and damage emission control components.

The fuel fill cap is opened by turning the cap counter clockwise until it can be removed. After refueling, replace the fill cap and tighten until it clicks, indicating that the cap has been properly closed and the fill system is sealed. Wash the areas around the fuel fill if any fuel splashed on the deck or hull during filling operations. Residual fuel left on the deck and hull sides can be dangerous and will yellow the fiberglass or damage the striping.

Be sure to use the proper type and grade fuel. Refer to the engine owner's manual for additional information.

Fuel Fill - International Fuel Systems

Boats sold in countries other than the United States are not equipped with sealed fuel fill systems or vapor emission control components. The fuel tank is vented through the fill fitting and cap. A "keyless" fuel cap is located on the port gunnel that is marked "GAS." The fuel fill cap is designed to seal out water and allow the fuel tank to vent to the atmosphere when the cap is installed and tight.

The fuel fill is opened by turning the cap counter clockwise until it can be removed. After fueling, install the fuel cap and tighten. Be sure to use the proper type and grade fuel. Refer to the engine owner's manual for additional information.

Notice:

Do not overtighten the fuel cap on boats with international fuel systems. If the cap is overtightened, the O-ring seal could be damaged allowing water to contaminate the fuel system.

Fuel Vent - U.S. Fuel Systems

In order to comply with U.S. EPA regulations, the fuel tank is equipped with a special vent located on the hull side and vent system emission control components. A carbon filled canister in the vent hose between the fuel tank and the vent absorbs fuel vapors before they can escape to the atmosphere and returns them to the fuel tank.

Carbon canisters can be damaged if they are repeatedly exposed to liquid fuel. Special valves in the vent system and the automatic shutoff valve on marina fuel pumps prevent the tank from being overfilled and forcing fuel into the vent system. You should never attempt to "top off" the tank after the pump shutoff has activated. This could force fuel into the vent system that can damage the carbon canister or other components.

Fuel Vent - International Fuel Systems

Boats sold in countries other than the United States are equipped with fuel tank vent systems incorporated into the fuel fill. The fuel fill cap is designed seal out water and allow the fuel tank to vent to the atmosphere when the cap is installed and tight.

While the tank is being filled, the air displaced by the fuel escapes through the vent and fuel fill. When the tank is full, a small amount of fuel could be ejected from the fuel fill/vent.

After fueling, replace the fill cap, and wash the areas around the fuel fill. Residual fuel left on the deck and hull sides can be dangerous and will yellow the fiberglass or damage the striping.



WARNING



DO NOT CONFUSE FUEL FILL DECK PLATES WITH THE WATER OR WASTE FILL DECK PLATES. THESE PLATES ARE ALSO LABELED ACCORDINGLY. IF GASOLINE IS ACCIDENTALLY PUMPED INTO THE WATER OR WASTE TANK, DO NOT ATTEMPT TO PUMP IT OUT YOURSELF. WATER AND WASTE PUMPS ARE NOT DESIGNED TO PUMP FUEL AND A FIRE OR EXPLOSION COULD RESULT. CONTACT YOUR DEALER OR THE MONTEREY CUSTOMER SERVICE DEPARTMENT FOR ASSISTANCE IN HAVING THE FUEL PROFESSIONALLY REMOVED.

5.2 Engine Fuel Delivery System

The fuel system on your boat has one fuel tank. The Fuel withdrawal line is equipped with an anti-siphon valve where the line attaches to the fuel tank. This valve prevents gasoline from siphoning out of the fuel tank should a line rupture.



WARNING



IF A FUEL LINE SHOULD LEAK, ANTI-SIPHON VALVES PREVENT A SUBSTANTIAL AMOUNT OF FUEL FROM FLOWING INTO THE BILGE. SHOULD AN ANTI-SIPHON VALVE BECOME CLOGGED, CLEAN AND REINSTALL OR REPLACE. DO NOT REMOVE THE ANTI-SIPHON VALVE FROM THE SYSTEM. ANTI-SIPHON VALVES ARE REQUIRED, BY THE U.S. COAST GUARD, TO BE INSTALLED IN ALL BOATS EQUIPPED WITH A GASOLINE ENGINE.



Typical Gas Spin On Engine Fuel Filter

Fuel Filter

Each gasoline engine is equipped with a fuel filter on the engine. Some engines are equipped with a spin on, water separator type fuel filter located on the engine. Other engines are equipped with fuel filters that are integrated into the fuel injection pump system.

Spin on fuel filters should be checked frequently and changed as recommended by the engine manufacturer to assure an adequate supply of clean, dry fuel to the engine.

Filters integrated into the fuel injection pump system require special service procedures. These filters must be serviced at regular intervals by a qualified technician.

Always refer to the engine manufacturer owner's manual for service intervals and instructions for servicing or replacing the fuel filters.



WARNING



BEFORE STARTING THE ENGINE, ALWAYS OPEN ALL HATCHES, WINDOWS, AND DOORS AND RUN THE BLOWER FOR AT LEAST FOUR (4) MINUTES TO COMPLETELY VENTILATE THE BOAT AFTER SERVICING THE FUEL SYSTEM.

5.3 Generator Fuel System

A generator is optional equipment on 328SS. The generator fuel system is much like the primary fuel engine fuel system. There is a separate fuel supply line equipped with an anti-siphon valve for the generator. A fuel shut-off valve is located on the fuel line near the filter. The valve should always be closed before servicing the fuel filter.

The generator withdrawal tube is shorter than the main engine withdrawal tubes to prevent the generator from consuming the reserve fuel. Therefore, the generator will run out of fuel if the fuel level in the tank drops below 1/4 of the tank.

A water separating fuel filter is located on the generator near fuel pump. The filter element should be replaced on the generator when the main engine fuel filters are changed.

5.4 Fueling Instructions

Boats sold in the United States are built with fuel systems designed to meet emission control standards established by the U.S. Environmental Protection Agency. Boat sold internationally (all countries other than the United States) are built with fuel system that are not equipped with U.S. EPA required emission controls.

The fueling procedure is somewhat different for each fuel system design. Consequently, fueling instructions in this section that are specific to each type of fuel system are identified as being for either boats with U.S. fuel systems or boats with international fuel systems. Procedures for preparing the boat for fueling at a marina and preparing the boat for operation when fueling is completed are the same for both fuel systems. Make sure to follow the correct fueling procedure for the system installed in your boat.

DANGER

FUEL IS VERY FLAMMABLE AND THE VAPORS CAN EXPLODE. BE CAREFUL WHEN FILLING THE FUEL TANK. NO SMOKING. NEVER FILL THE TANK WHILE AN ENGINE IS RUNNING. FILL THE FUEL TANK IN AN OPEN AREA. DO NOT FILL THE TANK NEAR OPEN FLAMES.

WARNING

TO PREVENT DAMAGE TO THE FUEL SYSTEM, USE ONLY A GOOD GRADE OF GASOLINE. DO NOT USE A FUEL THAT CONTAINS HARSH ADDITIVES OR MORE THAN A 10% ETHANOL ALCOHOL BLEND. ANY DAMAGE DONE TO THE FUEL SYSTEM THAT IS THE RESULT OF USE OF A HIGHER ALCOHOL BLEND IS NOT COVERED BY THE MONTEREY WARRANTY. REFER TO THE ENGINE MANUFACTURER OWNER'S MANUAL REGARDING FUEL REQUIREMENTS FOR YOUR ENGINE.

Preparing the Boat for Fueling - All Boats

Use the following procedure to prepare the boat for fueling at a marina fuel pump:

- Make sure the boat is securely moored and all engines are off.
- Make sure all switches are in the "OFF" position.
- Make sure all passengers leave the boat.
- Close all doors and hatches and make sure the blower is off to prevent fuel fumes from entering the engine compartment.

WARNING

GASOLINE FUEL VAPORS THAT ACCUMULATE IN THE BILGE OR ENGINE COMPARTMENT WHILE FUELING CAN EXPLODE!! FUEL VAPORS ARE HEAVIER THAN AIR AND CAN ACCUMULATE IF THEY ARE CARRIED BY THE WIND INTO THE BILGE AND ENGINE COMPARTMENT THROUGH OPEN DOORS, HATCHES OR VENTS. VAPORS CAN ALSO BE DRAWN INTO THE ENGINE COMPARTMENT BY THE BLOWERS. ALWAYS TURN BILGE BLOWERS OFF AND CLOSE DOORS AND HATCHES BEFORE FUELING.

- Estimate how much fuel is needed and avoid overfilling the fuel tank.

WARNING

STATIC ELECTRICITY GENERATED BY FLOWING FUEL CAN CAUSE A FIRE OR EXPLOSION. TO PREVENT STATIC SPARKS WHEN FILLING THE TANK, MAKE SURE THE NOZZLE IS ALWAYS IN CONTACT WITH THE FUEL FILL OPENING.

Fueling Boats Instructions For Boats Sold in the United States.

In order to comply with U.S. EPA emission regulations, boats sold in the United States are equipped with special fuel systems that prevent fuel vapors from entering the atmosphere when fueling operations are complete.

These fuel systems meet U.S. EPA emission standards and are designed to maintain a specific air space at the top of the fuel tank that provides proper tank ventilation and protection for emission control components. Special valves in the fuel tank vent system, the fuel fill and a shutoff valve in marina fuel pump nozzles are designed to automatically stop the fuel flow when the tank is full and maintain this air space.

NOTICE

When the fuel tank is full, the shutoff valve in the marina fuel pump will activate and automatically shut off the flow, indicating that the tank is filled to the maximum level. You should stop filling the tank at this point and never attempt to "top off" the tank. Attempting to "top off" the tank could damage fuel level control valves or force fuel into the vent system which could damage vapor emission control components.

To fill the fuel tank on boats with vapor emission control systems, follow this procedure:

- The fuel cap is designed to be opened by hand and does not require a key. Turn the cap counterclockwise to remove it for fueling.
- Make sure the nozzle is equipped with an automatic shutoff valve. Then put the nozzle in the fuel fill opening and make sure it stays in contact with the fuel fill fitting during the entire fueling operation.
- Fill the tank until the shutoff valve clicks and automatically stops the fuel flow.
- Remove the nozzle.
- Install the fuel cap and tighten until the cap clicks, indicating that the cap is tight and the system is sealed.

Fueling Boats with International Fuel Systems

Boats sold in countries other than the United States are not equipped with sealed fuel fill systems or vapor emission control components. The fuel tank is vented to the atmosphere through the fill fitting and cap. Consequently, the fueling process for boats equipped with international fuel systems is somewhat different than for boats sold in the United States.

NOTICE:

When the fuel tank is full, some fuel will surge out through the fuel fill/vent. The fuel tank vent is built into the fuel fill fitting located on the gunnel. Monitor the vent/fill closely while fueling to prevent fuel from spilling into the water.

To fill the fuel tank on boats with international fuel systems, follow this procedure:

- The fuel cap is designed to be opened by hand and does not require a key. Turn the cap counterclockwise to remove it for fueling.
- Put the nozzle in the fuel fill opening and make sure it stays in contact with the fuel fill fitting during the entire fueling operation.

- Fill the tank slightly less than the rated capacity to avoid spilling fuel out of the vent/ fuel fill and to allow for expansion.
- Remove the nozzle.
- Install and tighten the fuel cap. Make sure you don't overtighten the fuel cap and damage the O-ring seal.



WARNING



SPILLED FUEL CAN CAUSE A FIRE OR AN EXPLOSION. MAKE SURE YOU DO NOT SPILL ANY FUEL. IF A SMALL AMOUNT OF FUEL IS SPILLED ON THE FIBERGLASS, USE A CLOTH TO REMOVE THE FUEL AND PROPERLY DISPOSE OF THE CONTAMINATED CLOTH. IF FUEL IS SPILLED ON THE WATER, EXERCISE EXTREME CAUTION. FUEL FLOATS ON THE SURFACE OF THE WATER AND CAN IGNITE. IF FUEL IS SPILLED INTO THE WATER, IMMEDIATELY EVACUATE THE AREA AND NOTIFY THE MARINA AND THE PROPER OFFICIALS.

Preparing the Boat for Operation - All Boats

Use the following procedure to prepare the boat for operation when fuel operations are complete:

- Open all hatches, windows and doors. **Run the blower for at least four minutes to completely ventilate the boat.**
- Check the fuel compartment and below the deck for fuel odors. If you smell fuel, do not start the engine.



DANGER



GASOLINE FUEL VAPORS THAT ACCUMULATE IN THE CABIN OR ENGINE COMPARTMENT WHILE FUELING CAN EXPLODE!! TO REDUCE THE RISK OF A FIRE AND/OR EXPLOSION AFTER FILLING THE FUEL SYSTEM, ALWAYS RUN THE BLOWER FOR AT LEAST FOUR (4) MINUTES AND OPEN ALL HATCHES, WINDOWS, AND DOORS TO COMPLETELY VENTILATE THE BOAT BEFORE STARTING THE ENGINE.

5.5 Fuel System Maintenance



Periodically inspect all connections, clamps and hoses for leakage and damage or deterioration. Replace as necessary. Spray the valves, tank fuel gauge sender and ground connections with a metal protector.

Frequently inspect and lubricate the fuel fill cap O-ring seal with Teflon or silicone grease. The O-ring seal prevents water from entering the fuel system through the fuel fill cap and should be replaced immediately if there is any sign of damage or deterioration.

Contaminated fuel may cause serious damage to your engine. The filters must be checked for water and other contamination frequently. Gasoline engine filters must be changed at least once each year or more frequently depending on the type of engine and the quality of the fuel. Refer to the engine manufacturer's instructions for information on servicing and replacing the fuel filter elements.



The age of gasoline can affect engine performance. Chemical changes occur as the gasoline ages that can cause deposits and varnish in the fuel system as well as reduce the octane rating of the fuel. Severely degraded fuel can damage the engine and boat fuel tank and lines. Therefore, if your boat is not being run enough to require at least one full tank of fresh fuel a month, a fuel stabilizer should be added to the gasoline to protect the fuel from degradation. Your dealer or the engine manufacturer can provide additional information on fuel degradation and fuel stabilizers recommended for your engine.

In many states, most gasoline is blended with ethanol alcohol. Ethanol is a strong solvent and can absorb water during periods of storage. You should refer to the engine operating manual for information regarding alcohol blended fuels and how it affects the operation of your marine engine.



 **WARNING** 

LEAKING FUEL IS DANGEROUS AND CAN CAUSE A FIRE AND/OR EXPLOSION. DO NOT DRAIN ANY FUEL INTO THE BILGE.



AFTER THE FILTER ELEMENT HAS BEEN CHANGED, PRIME THE FUEL SYSTEM AND CHECK ALL FITTINGS FOR LEAKS BEFORE AND AFTER STARTING THE ENGINE FOLLOWING ANY FUEL SYSTEM SERVICE.

 **WARNING** 

TO REDUCE THE POSSIBILITY OF A FIRE OR EXPLOSION, MAKE SURE ALL ELECTRICAL SWITCHES ARE IN THE "OFF" POSITION BEFORE SERVICING THE FUEL SYSTEM.

 **WARNING** 

BEFORE STARTING THE ENGINE, ALWAYS OPEN ALL HATCHES AND DOORS. THEN RUN THE BLOWER FOR AT LEAST FOUR (4) MINUTES TO COMPLETELY VENTILATE THE BOAT AFTER SERVICING THE FUEL SYSTEM.

 **DANGER** 

AVOID SERIOUS INJURY OR DEATH FROM FIRE OR EXPLOSION RESULTING FROM LEAKING FUEL, INSPECT SYSTEM FOR LEAKS AT LEAST ONCE A YEAR. DO NOT DRAIN ANY FUEL INTO THE BILGE.

ELECTRICAL SYSTEM

6.1 General

Your Monterey is equipped with a 12 volt DC electrical system. Some models could also be equipped with an optional 120 volt AC battery charging system or 120 volt AC electrical system and a generator. Battery chargers on boats that don't have a 120 volt AC electrical system draw current directly from a shore power outlet at dockside. AC systems can draw current from one of two sources, either shore power outlets at dockside or an optional generator. The DC system draws current from on board batteries.

Most boat and engine charging systems are designed for 12 volt, lead acid wet cell, absorbed glass mat (AGM) or gel cell marine batteries. Most wet cell batteries will require similar maintenance as those in automobiles. AGM, gel cell and some wet cell batteries are sealed and require no maintenance except to periodically clean battery tops, terminal posts and connections.

All wires in the electrical system are color coded to make identifying circuits easier. Wiring schematics have been included with this manual to aid in following an individual circuit of the boat.

Single engine model DC battery systems are different than the DC battery systems in twin engine boats. Consequently, the 12 volt DC battery system in this chapter is in two sections, 6.2 Single Engine Battery Systems and 6.3 Twin Engine Battery Systems.

Jumper Terminals

Jumper terminals are installed on 328SS models to supply 12 volt current to the electric engine hatch lifter if the boat batteries are dead. Two jumper terminals located near the battery switches and an included harness provide the ability to supply 12-volt power from a jumper battery to the engine hatch electrical circuit to open the engine compartment. These terminals and the harness provided are only for activating the engine hatch lifting system and not for starting the engine or charging the batteries.



Typical Battery Switch Panel For Single & Dual Battery Systems
214SS/218SS & 234SS/238SS



Typical Dual Battery Installation In Cockpit Storage Compartment
214SS/218SS & 234SS/238SS

6.2 Single Engine Battery Systems

The 12 volt electrical system on single engine boats is a standard marine system. One battery with an ON/OFF switch is standard equipment on most single engine models. A dual battery system is standard on the 288SS and optional on other models.

The batteries are located in the rear of the storage compartment below the cockpit, at the front of the compartments on each side of the engine or below the stern seat. The single battery system is controlled by an ON/OFF battery switch. Dual batteries are controlled by an OFF/1-2 /1

& 2 (Both) battery selector switch or an ON/OFF switch for the engine START battery, an ON/OFF switch for the HOUSE battery and an EMERGENCY PARALLEL ON/OFF switch. The battery switches are located in a panel below the center stern seat cushion or in a compartment in the starboard side of the cockpit near the transom door. The batteries are charged by the engine or the optional battery charger when hooked to shore power.

Circuit Protection

214SS/218SS/234SS/238SS/268SS

All 12 volt power is distributed to the 12 volt accessories through individual circuit breakers located in the 12 volt breaker panels. A main helm circuit breaker, located near the battery switch, protects the system from an overload. Other circuit breakers, located near the selector switch, protect the circuits for the automatic float switch for the bilge pump, optional amplifier, ignition and optional windlass. Other fuses or circuit breakers in the engine compartment protect the circuits for the optional Mercathode active corrosion system, battery charger and windlass on some models. Most 12 volt accessories are operated directly by switches in the helm accessory switch panels or separate accessory switch panels.

Main breakers located on the engine protect the ignition, engine charging system and gauges. Some 12 volt accessories are operated directly by a circuit breaker in the breaker panels while others are operated by a switch fed by the panel breakers. Most of the 12 volt accessories on the deck and in the cockpit are operated by switches in the helm switch panel.

288SS Circuit Protection

All 12 volt power is distributed to the 12 volt accessories through individual circuit breakers or fuses located in the 12 volt breaker and fuse panels. A main helm circuit breaker, located near the battery switch, protects the system from an overload. Other circuit breakers, located near the selector switches, protect the circuits for the bilge pump automatic float switches, ignition, optional stereo amplifier, helm accessory panel, trim tabs, interior lights, water pump, sump pump, stereo, arch, 12 volt receptacle, cockpit refrigerator, macerator and optional windlass. Other fuses or circuit breakers in the engine compartment protect the circuits for the optional Mercathode active corrosion system, battery charger and windlass. Most 12 volt accessories are operated directly by switches in the helm accessory switch panels or separate accessory switch panels.



Typical 268SS Dual Battery Switch Panel

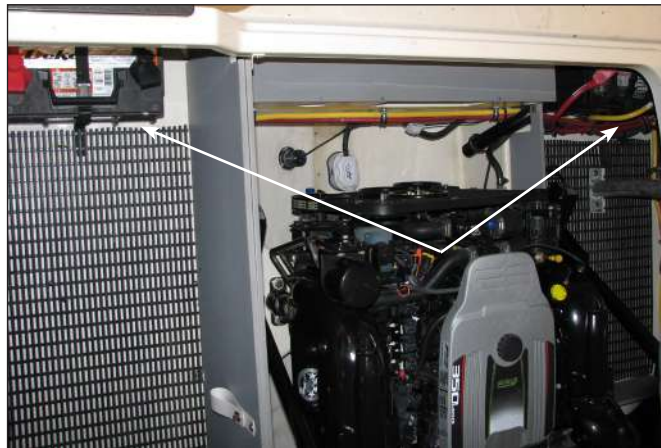

268SS Dual Battery Mounting Location In Engine Compartment



268SS Battery Installation

Main breakers located on the engine protect the ignition, engine charging system and gauges. Some 12 volt accessories are operated directly by a circuit breaker in the breaker panels while others are operated by a switch fed by the panel breakers or the power management module behind the helm. Most of the 12 volt accessories on the deck and in the cockpit are operated by switches in the helm switch panels.

⚠
CAUTION
⚠

PROPER FUSE OR BREAKER PROTECTION MUST BE PROVIDED FOR ALL 12 VOLT EQUIPMENT ADDED. DO NOT OVERLOAD THE ACCESSORY CIRCUIT BREAKERS OR OTHER CIRCUITRY THROUGH ADDITIONAL 12 VOLT EQUIPMENT.

Batteries and Battery Switch

The DC electrical system on your boat is designed for wet cell, absorbed glass mat or gel cell marine batteries. It is important that you know the type of batteries in your boat and that the engine charging system and optional battery charger are set to recharge these batteries. Charging systems not set to the proper battery type could cause unusually short battery life, engine starting problems and damage to the DC charging systems. You also should not mix the brand or type of batteries.

Your boat has provision for one or two batteries. The batteries should be of the size and capacity recommended by the manufacturer of your engine. See the engine owner's manual for more information on battery requirements. These specifications should be considered to be the minimum size battery required. The batteries were installed by your dealer. Always consult your dealer before changing the type of batteries in your boat or if you questions regarding the batteries.

Boats with One Battery & One Battery Switch

On boats with one battery, the battery switch feeds the engine and the 12 volt accessory panels. The battery switch has two positions, OFF & ON. When the battery switch is ON, the engine and accessory circuits are activated simultaneously and current flows from the battery to the engine, accessories and electronics. When the switch is in the OFF position, the engine and all DC circuits are deactivated except for the automatic bilge pump switch and electronic engine control memory which remain activated.

Boats With Two Batteries & One Battery Switch

On boats with two batteries and one battery switch, the battery switch will have four positions, OFF, 1, 2 and 1 & 2 (both). The operator can set the switch to supply 12 volt power by either battery # 1 or battery # 2 separately or by both batteries simultaneously. The selector switch also directs the charging current when the engine is operating.

For example: When the switch is on battery # 1, the engine and the 12 volt system will be supplied



288SS Dual Battery Switch Panel & Circuit Protection

power by battery # 1. Battery # 2 will be isolated and in reserve. Battery # 1 will be charged by the alternator. When the selector switch is on battery # 2, the engine and the 12 volt system will be supplied power by battery # 2. Battery # 1 will be isolated and in reserve. Battery # 2 will then be charged by the alternator. When the selector switch is on "1 & 2," the batteries are connected in parallel so the engine and the 12 volt system will be supplied power by both batteries. Both batteries will be charged by the alternator.

The "1 & 2" position should only be used when starting the engine, as this requires extra electrical power, or when both batteries are low and need charging. Otherwise, it is recommended that the selector switch be set on battery # 1 or battery # 2 when the engine is operating. While in port or at anchor, the battery selector switch should be set to either the battery # 1 or the battery # 2 position. This will keep one battery in reserve for starting the engine. The battery switch should be turned to the "OFF" position when leaving the boat unattended.

Boats With Two Batteries & Three Battery Switches

288SS models are equipped with two batteries and three battery switches, a switch for the engine, a battery switch for the house and accessory circuits and an emergency battery parallel switch to provide additional starting power in an emergency. An automatic isolator/relay controls the charging of the engine and house batteries whenever the engine is operating.

When in port or at anchor, the ENGINE and EMERGENCY PARALLEL switches should be OFF. Only the HOUSE battery should be ON. This will keep the engine starting battery in reserve for starting the engine. If the house battery becomes discharged the engine can be started to recharge the house battery by turning ENGINE battery ON and starting the engine.

The engine battery is dedicated to starting and operating the engine. If the engine battery becomes discharged, the engine and house batteries can be temporarily connected in parallel with the EMERGENCY PARALLEL switch to provide additional starting current for the engine. To connect the batteries in parallel to start the engine, make sure the ENGINE battery switch is ON, then turn the EMERGENCY PARALLEL switch to ON and start the engine. Once the engine has started and systems have stabilized, turn the EMERGENCY PARALLEL switch OFF. Once the engine is running the automatic isolator relay will direct charging current to both batteries with the lowest battery receiving the most charging current.

NOTICE:

Current is supplied to the automatic float switch for the bilge pump, electronic engine control memory and stereo memory when the batteries are connected, even if the battery switch is off.

6.3 Twin Engine Battery System

The 12 volt electrical system on the 328SS twin engine boats is a standard marine system. Three batteries with an ON/OFF switch for each battery and an emergency parallel switch is standard equipment. The batteries are located in the front of the engine compartment. The battery switch panel is located in a compartment on the side of the cockpit near the transom door. The batteries are charged by the engine or by the battery charger when hooked to shore power or when the optional generator is operating.



All 12 volt power is distributed to the 12 volt accessories through individual circuit breakers located in the 12 volt breaker panels. A main helm circuit breaker, located near the battery switches, protects the system from an overload. Other circuit breakers, located near the battery selector switches, protect the circuits for the bilge



288SS Battery Installation Below Port Stern Seat

pump automatic float switches, ignitions, optional stereo amplifier, helm accessory panel, trim tabs, interior lights, water pump, sump pump, stereo, arch, 12 volt receptacle, cockpit refrigerator, macerator and optional windlass. Other fuses or circuit breakers in the engine compartment protect the circuits for the optional electronic active corrosion systems, battery charger and windlass. Most 12 volt accessories are operated directly by switches in the helm accessory switch panels or separate accessory switch panels.

Main breakers located on the engine protect the ignition, engine charging systems and gauges. Some 12 volt accessories are operated directly by a circuit breaker in the breaker panels while others are operated by a switch fed by the panel breakers and/or the power management module behind the helm. Most of the 12 volt accessories on the deck and in the cockpit are operated by switches in the helm switch panels.

	CAUTION	
PROPER FUSE OR BREAKER PROTECTION MUST BE PROVIDED FOR ALL 12 VOLT EQUIPMENT ADDED. DO NOT OVERLOAD THE ACCESSORY CIRCUIT BREAKERS OR OTHER CIRCUITRY THROUGH ADDITIONAL 12 VOLT EQUIPMENT.		

Batteries and Battery Switches

328SS models are equipped with three batteries and four battery switches, a switch for each engine, a battery switch for house and accessory circuits and an emergency parallel switch. An automatic isolator/relay controls the charging of the house batteries whenever the starboard engine is operating. The port engine battery is dedicated to starting and operating the port engine. It is charged by the port engine whenever the port engine is operating. The port and starboard engine batteries can be temporarily connected in parallel by the EMERGENCY PARALLEL switch to provide additional starting current for each engine. The engine and house batteries are also charged by the battery charger whenever it is operating.

When in port or at anchor, the port and starboard engine battery switches should be OFF. Only the battery switch that activates the house and accessory circuits should be ON. This will keep both engine starting batteries in reserve for starting the engines. If the house battery becomes discharged to the point that accessories stop operating properly or the optional generator will not start, the starboard engine can be started to recharge the house battery.

NOTICE:

Current is supplied to the high water alarm and automatic float switches for the bilge pumps, the electronic corrosion controllers and the cabin CO monitor when the batteries are connected and the battery switches are off.

To connect the batteries in parallel to start the engine, make sure the ENGINE battery switches are ON, then turn the EMERGENCY PARALLEL switch to ON and start each engine. Once the engines have started and systems have stabilized, turn the EMERGENCY PARALLEL switch OFF.

Once the starboard engine is running, the alternator will charge the starboard engine battery. As the voltage in the battery raises to a preset level, the automatic isolator relay between the starboard engine battery and the house batteries will close and direct charging current to the house batteries. The starboard engine battery and house batteries will continue to be charged until the engine is shut down and the automatic relay opens, isolating the



328SS Battery Switch Panel

house batteries from the engine battery. The port engine battery will be charged by the port engine charging system.

The DC electrical system on the 328SS is designed for wet cell, gel cell or AGM marine batteries. The battery charger is equipped with a switch to select the type of batteries to be charged. The batteries will be damaged if the charger is not set properly. You should refer to the battery charger owner's manual to make sure the charger is set to the type of batteries in your boat and do not mix the type or brand of marine batteries.

The batteries were installed by your dealer. Labels on the battery cables indicate the specifications for the batteries required to power the house and engine electrical systems. Always consult your dealer before changing the type of batteries in your boat or if you have questions regarding the batteries.



Helm Switch Panels
214SS/218SS & 234SS/238SS



268SS Helm Switch Panels

6.4 12 volt Accessory Switch Panels

The main accessory switch panels and the engine start switch are located at the helm. The circuit breakers or fuses that protect the accessories and activate the engine starting circuits are located in a breaker panel or the power management module in the compartment behind the helm. Two types of helm switch panels are used on Super Sports models. 218SS, 238SS and 268SS models use a conventional helm switch panel with circuit protection in a separate breaker panel. 288SS and 328SS models use a digital helm switching system with circuit protection in the power management/fuse panel.

Conventional Helm Switch Panels

Conventional helm switch panels are equipped with rocker switches that are labeled for the accessories they control. An LED light built into most switches indicates that the circuit is activated. Conventional switches connect the full current load to each accessory. Each circuit is protected by individual "push to reset" circuit breakers located in a panel in the helm below the switches or in the storage compartment forward of the helm.

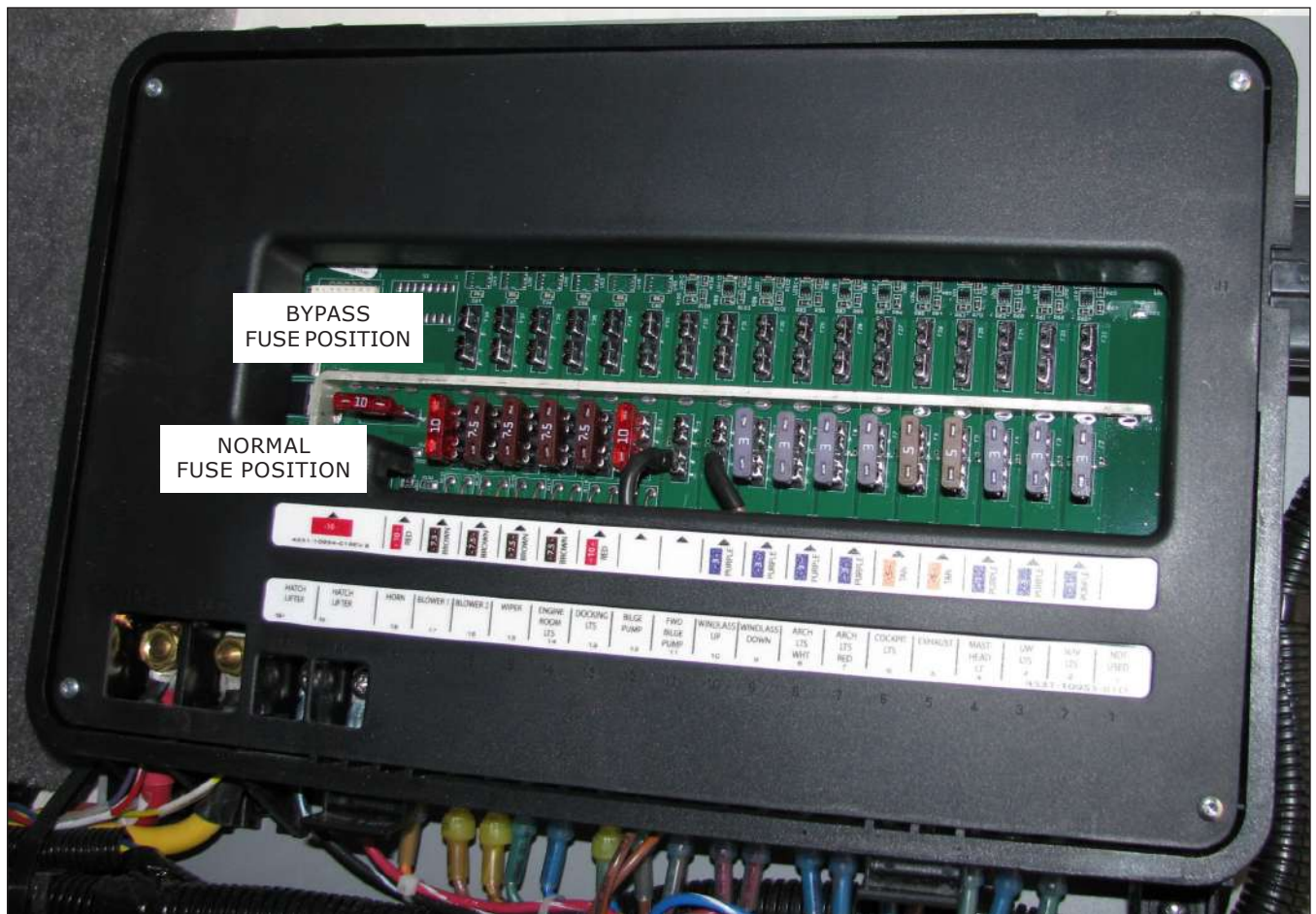

Power Management Module - MUX

Digital Helm Switch Panels

Digital switching systems provide reduced complexity and increase switching options at the helm. The system consists of 3 major parts: The power management module, the switch harness and the two digital switch modules at the helm. The power management module (or MUX module-which is short for multiplexing) is located in the compartment forward of the helm station. The MUX module is the central brain for the system. It is powered by the helm main breaker located on the battery switch panel. Each circuit is protected by individual spade type fuses located in a fuse panel built into the MUX module. The MUX module is also where the switching of input and output current load to the selected accessories takes place. The controllers in the MUX module recognize low voltage, digital signals from the push button switches in the modules and activate the correct combination of circuits for each switch function (i.e. the navigation lights switch actually forces the forward navigation lights and the anchor light to be turned on at the same time).



Lights Page - Digital Switch Panel



Boat Page - Digital Switch Panel

In the unlikely event of a switch failure, the fuse can be moved into the bypass position. Simply remove the fuse from the lower (normal) fuse holder and place it into the upper (bypass) holder.

The corresponding circuit will now be "ON" for as long as the fuse is in that position and no longer be controlled from the switch module. When the problem is corrected, move the fuse back to the original position for normal operation.

The digital switch modules at the helm are your interface to the digital system. Each module consists of four pages organized into logical groups. To change pages, press the vertical button on the left hand side of each switch module. The system will scroll to the next page with each press of the button. LCD labels next to the vertical switches identify the page. Other LCD labels above each switch identify the accessories available on that page. The LCD panels for each switch also indicate switch status, usually ON or OFF. Interior or cockpit light switches may also indicate the color of multicolored LED lights activated as well as their ON or OFF status. All switches are a "press to activate" and "press to deactivate" design.

Additionally, the port and starboard modules are set up slightly different. In the interest of safety, the horn switch is located at the far right of the starboard switch module and is present in all four pages so as to be readily accessible at all times.

Other items to note regarding the digital switching system:

- Most functions are repeated between both switch modules.
- The switches are turned on and off by the house battery switch.
- Digital switch module constitute a small drain on the house battery. Therefore, do not leave your HOUSE battery switch on for extended periods of time when the boat is unattended unless it is boat plugged into shore power with the battery charger on.
- The port switch module will default to the "Lights" screen when it is first powered on and the starboard module will default to the "Critical" screen.
- The backlights for the gauges are turned on using the "Anchor Nav" switch. Whenever this switch is on, the gauges will illuminate.
- Some of the functions shown on the screens may control optional equipment (i.e. windlass, exhaust, underwater lights)
- The cockpit lights will alternate between white and blue each time they are powered on.



Night Page - Digital Switch Panel



Critical Page - Digital Switch Panel

Helm Switch Activated Accessories

The following is a description of the accessories typically controlled by the helm switch panels. Some of the accessories described in this section are model specific or optional equipment on some models and may not be installed or available on your boat.

Ignition Switch

Each ignition switch is a separate, key activated switch, located near the helm below the steering wheel, which starts and stops the engine. The switch has OFF-ON and momentary START positions. To start the engine, make sure the outdrive is down and your hand is on the engine control handle in the neutral position. Turn the ignition key to the START position. When the engine starts, release the key and the switch will automatically go to the run position. Stop the engine by turning the key to the OFF position. The ignition circuits are protected by a breaker located in the main DC breaker panel and main breakers located on the engine.

Nav/Anchor Lights

Conventional switches are a three-position switch. The middle position is "OFF." Moving the switch in one direction will activate the navigation lights. Moving the switch in the opposite direction activates the anchor light.

Digital switch panels will have a switch for navigation lights and another switch for the anchor lights.

Docking Lights

Activates the docking lights in the bow.

Cockpit Lights

Activates the lights that illuminate the cockpit and bow seating area. Also activates the stern storage compartment and engine compartment lights on some models.

Digital switches will alternate light color each time the button is pressed.

Arch Lights

Activates the lights in the arch that illuminate the cockpit, bow seating area, stern storage compartment, helm storage compartment and engine compartment.

Digital switches will alternate light color each time the button is pressed.

Engine Room Lights



Activates the 12-volt lights in the engine compartment.

Underwater Lights

Activates the underwater lights in stern below the water line.

Blower

This switch supplies electrical current to the blower that provides ventilation to the engine compartment.

WARNING	
	
GASOLINE VAPORS CAN EXPLODE. BEFORE STARTING THE ENGINE, OPERATE THE BLOWER FOR FOUR (4) MINUTES. OPEN THE ENGINE COMPARTMENT HATCH, INSPECT THE FUEL SYSTEM AND CHECK FOR THE ODOR OF GASOLINE VAPORS. ALWAYS OPERATE THE BLOWER WHILE THE ENGINE IS OPERATING BELOW CRUISE SPEED. UNDER NO CIRCUMSTANCES SHOULD THIS PROCEDURE BE OVERLOOKED.	

Engine Hatch (some models)

Conventional engine hatch switches are an ON-OFF-ON momentary switch that controls the electric actuator for the engine hatch. Press the top of the switch to raise engine hatch. Press the bottom of the switch to close hatch. The switch automatically returns to the OFF position when it is released.

Digital switch panels have a separate momentary switch for hatch up and hatch down.

Bilge Pump

Manually activates the aft bilge pump which is installed in the bilge just forward of the engine. The pump moves water out through the thru-hull fitting in the hull. To start the pump, place the switch in the "ON" position.

Fwd Bilge (some models)

Manually activates the forward bilge pump located in the forward bilge. The pump moves water out a thru-hull fitting in the hull. The pump is also activated by an automatic switch that is activated whenever the batteries are connected. This pump will run as needed whenever the water in the bilge accumulates high enough to cause the switch to activate and turn off when the water is removed.

NOTICE:

The bilge pumps will start automatically when there is sufficient water in the bilge to activate the electronic water level switch built into each pump. The automatic switch is protected by a circuit breaker located in the battery switch panel and is always supplied current when the batteries are connected. Refer to the Drainage Systems chapter for more information on the bilge pump system.

Windlass Switch

This switch controls the optional windlass which is mounted to the deck directly above the rope locker. It is protected by a circuit breaker of the type and rating recommended by the windlass manufacturer that is located in the cabin breaker panel. There could also be a switch to control the windlass in the winch compartment next to the windlass.

Digital switch panels have a separate momentary switch for windlass up and windlass down.

Wipers

Activates the windshield wipers.

Water System

Activates the fresh water pump. The pump is the pressure demand type. The pressure switch built into the pump automatically controls the water pump when the system is activated and properly primed.

Horn

Activates the boat horn.

Digital switch panels will have a horn button on each page for safety purposes.

Exhaust

Activates the diverter valve in the exhaust system that directs the exhaust either through the outdrive and propeller or to the thru-hull exhaust system for increased performance and enhanced sound.

Engine Data

A momentary switch that toggles through available engine data that displays on the tachometer LCD data screen on some models.

Accessory

Reserved for additional 12 volt equipment.

Additional Accessory Switches & Panels

Additional switch panels are located in various locations in the helm, cockpit and head compartment. The following is a description of additional panels that may be on your boat and the accessories they control. Some of the accessories described in this section are model specific or optional equipment on some models and may not be installed or available on your boat.

Trim Tab Switch

Located in the helm. This switch controls the trim tabs located on the transom of the boat. Please refer to the Helm Control Systems chapter for detailed information on the operation of the trim tabs.

Engine Trim and Tilt Switch

Located in the helm. This switch is usually installed in the engine control handle. It controls the trimming and tilting of the outdrive. Please refer to the Helm Control Systems chapter and the engine owner's manual for information regarding the proper use of the tilt and trim switch.

Stern Engine Trim and Tilt Switch

Located near the transom door. It allows the operator to tilt the outdrive at the rear of the boat for trailering and shallow water situations. It controls the tilting of the outdrive only when the engine is shutdown. It will not operate while the engine is running or when the ignition switch is ON.



Typical Outdrive Tilt Switch Near Transom Door



Helm Stereo Control Pad

Helm Stereo Control Pad

Located in the helm. Controls the stereo. Refer to the stereo owner's manual for details on operating the stereo control pad.

Stern Mount Stereo Control Pad (Optional)

Located in the stern above the swim platform near the transom door or aft seat. Controls the stereo. Refer to the stereo owner's manual for details on operating the stereo control pad.

Cockpit Stereo Control Pad (Optional)

Located in the cockpit. Controls the stereo. Refer to the stereo owner's manual for details on operating the stereo control pad.

WARNING

KEEP HANDS AND FEET AWAY FROM DRIVE UNIT WHEN TILTING.

Aft Seat Switch (328SS)

Located in the battery switch compartment near the transom door. A momentary ON - OFF - ON switch that controls the 12 volt motor that raises and retracts the aft seat backrest above the engine compartment. Press and hold the top of the switch to extend (recline) the seat. Press and hold the bottom of the switch to retract (raise) the seat to the up position. Release the switch and the seat stops in the current position.

Water System

Located in the battery switch panel on some models. Activates the fresh water pump. The pump is the pressure demand type. The pressure switch built into the pump automatically controls the water pump when the system is activated and properly primed.

Holding Tank Macerator

The holding tank overboard discharge macerator switch panel is located in the head compartment next to the holding tank monitor. It is a momentary switch that activates the macerator discharge system for the holding tank. Refer to the Marine Head System in the Interior Equipment chapter for additional information on the operation of the overboard macerator discharge system.

Automatic Fire Extinguisher Indicator Panel

The panel is equipped with a light that indicates the status of the automatic fire extinguishing system. When the green light is lit, it indicates the system is charged and ready. If the green light is not lit, the system has discharged.

If the system discharges, the fire extinguishing agent will shut down the engine, which can be restarted once the fire extinguishing agent has dissipated from the engine compartment. Refer to the Automatic Fire Extinguishing System in the Safety Equipment chapter and the manufacturer's owner's manual for more information on the operation of the automatic fire extinguishing system.

12 volt Receptacles

Provides electrical current for portable 12 volt equipment. Some models are equipped with more than one 12 volt accessory plug. One is usually in the helm panel near the accessory switches and others could be located in the cockpit or in the cabin.

MP3 Connection

Provides an input for MP3 players to connect to the boat stereo system. Some models are equipped with more than one 12 volt accessory plug. One is usually in the helm panel near the accessory switches and others could be located in the cockpit or in the cabin.



Battery Switch & Circuit Breaker Panel
214SS/218SS,234SS/238SS & 268SS

6.5 Circuit Breaker Panels (214SS/218SS/234SS/238SS/268SS)

Power is distributed to most of the 12 volt accessories through individual circuit breakers located in the DC breaker panels. The following is a description of circuit breaker panels and the accessories they control. Some accessory circuit protection described in this section are model specific or optional equipment on some models and may not be installed or available on your boat.

Circuit Breaker Panels

There are two DC breaker panels, the battery switch breaker panel and the accessory breaker panel located below the helm or in the storage compartment forward of the helm. Main breakers located in the battery switch panel protect the system from an overload. Some 12 volt accessories are operated directly by the circuit breaker in the panels while others are operated by switches fed by the panel breakers.

Battery Switch Panel Breakers

The following is a description of the accessories controlled by the "push to reset" and main DC breakers in the battery switch panel.

Main

The primary circuit for the main DC panel near the helm is protected and powered by this circuit breaker. Other circuit breakers located in the main DC breaker panel protect the individual DC circuits. This "push to reset" breaker is supplied current when the battery switch is activated.

Amplifier (Optional)

A "push to reset" circuit breaker that provides protection and power for the stereo amplifier for the boat speaker system. This breaker is supplied current when the battery selector switch is activated.

Bilge Pump

Provides protection and power for the automatic float switch on the aft bilge pump. This "push to reset" breaker is always supplied current when the batteries are connected. Another breaker in the main DC breaker panel provides circuit protection for the manual switch.

Ignition

Provides protection and continuous power for the computer memory for the engine. This "push to reset" breaker is always supplied current when the batteries are connected.

Helm Accessory Breaker Panel

The accessory breaker panel is located below the helm or in the storage compartment forward of the helm. The following is a description of the accessories protected by the "push to reset" breakers in the accessory breaker panel:

Horn

Provides protection and electrical current to the switch that activates the horn.

12V Recept

Provides protection and electrical current directly to the 12 volt accessory plugs in the cockpit.

Blower

Provides protection and electrical current to the switch that activates the bilge blower in the engine compartment.

Nav/Anc

Provides protection and electrical current to the switch that activates the navigation lights.

Cockpit Lights

Provides protection and electrical current to the switch that activates the cockpit lights.

Stereo

Provides protection and electrical current to the stereo located in the compartment on the starboard side of the cockpit.

Water System

Provides protection and electrical current to the switch that activates the pump for the fresh water system. A pressure switch automatically controls the water pump when the system is activated and properly primed.



Helm Accessory Circuit Breaker Panel
214SS/218SS & 234SS/238SS



268SS Helm Accessory Circuit Breaker Panel

Underwater Lights

Provides protection and electrical current to the switch that activates the underwater lights in stern below the water.

Arch Lights

Provides protection and electrical current to the switch that activates the lights in the arch that illuminate the cockpit.

Docking Lights

Provides protection and electrical current to the switch that activates the docking lights.

Head System (268SS)

Provides protection and electrical current directly to the vacuum pump on the electric head system. A vacuum switch on the pump automatically controls the pump and maintains proper vacuum in the system.

Macerator (268SS)

Provides protection and electrical current to the holding tank monitor and the optional macerator pump switch in the head compartment.

Trim Tabs

Provides protection and electrical current to the switches that control the optional trim tabs.

Hatch Lifter (268SS)

Provides protection and electrical current to the switch that controls the electric engine hatch lifter.

Bilge

Provides protection and electrical current to the switch that manually activates the aft bilge pump.

Electronics

Provides protection and electrical current directly to the electronics in the helm.

Acc #1

Reserved for additional 12 volt equipment.

Acc #2

Reserved for additional 12 volt equipment.

Acc #3

Reserved for additional 12 volt equipment.

Engine Main Breakers

The primary circuits for the engine is protected by heavy duty, "push to reset" breakers on each engine. They are supplied power whenever the engine battery switches are on. Refer to the engine owner's manual for information on the location and operation of the engine circuit breakers.

Windlass Circuit Breaker (268SS)

A heavy duty circuit breaker that provides protection and power for windlass relay. This breaker is supplied current when the battery selector switch is activated. If the circuit breaker is tripped by an overload, a red lever will be exposed near the center of the breaker. Reset the breaker by raising the lever until it locks in the horizontal position.

6.6 Circuit Breaker Panels (288SS/328SS)

Power is distributed to most of the 12 volt accessories through individual circuit breakers located in the DC breaker panels or fuses in the power management module for the digital switching system. The following is a description of circuit breaker panels and the accessories they control.

Some accessory circuit protection described in this section is for equipment that is optional on some models and may not be installed or available on your boat

There are two DC breaker panels, the battery switch breaker panel and the helm or cabin accessory breaker panel located below the helm or in the or in the cabin. Accessories activated by the

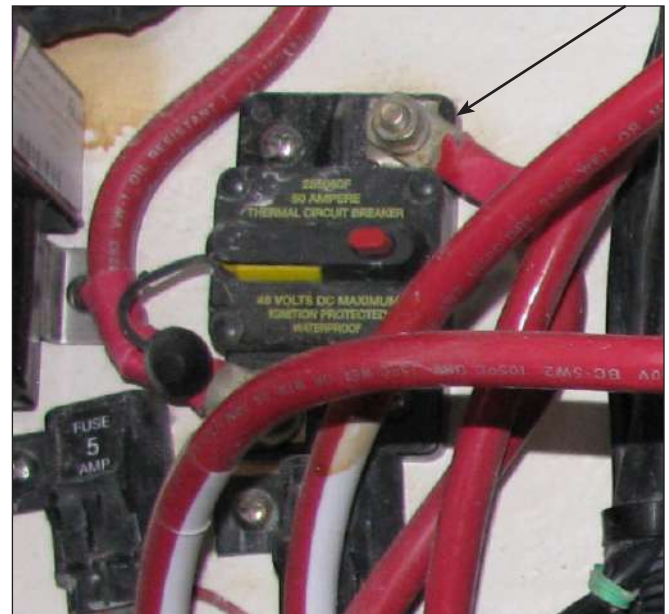

268SS Windlass Circuit Breaker
Near Starboard Battery In Engine Compartment

digital switching system in the helm are protected by fuses in the power management module.

Main breakers located in the battery switch panel protect the system from an overload. Some 12 volt accessories are operated directly by the circuit breaker in the panels while others are operated by switches fed by the panel breakers.

288SS Battery Switch Panel Breakers

The following is a description of the accessories controlled by the "push to reset" and main DC breakers in the 288SS battery switch panel.

Helm Main

The primary circuit for the main DC panel near the helm is protected and powered by this circuit breaker. Other circuit breakers located in the main DC breaker panel protect the individual DC circuits. This "push to reset" breaker is supplied current when the HOUSE battery switch is activated.

Stereo Amp

A "push to reset" circuit breaker that provides protection and power for the stereo amplifier for the boat speaker system. This breaker is supplied current when the battery selector switch is activated.

Head System

Provides protection and electrical current directly to the electric head system.

Helm ACC Panel

The primary circuit for the helm or cabin accessory breaker panel near the helm or in the cabin is protected and powered by this circuit breaker. Other circuit breakers located in the helm or cabin DC breaker panel protect the individual circuits. This "push to reset" breaker is supplied current when the HOUSE battery switch is activated.

Trim Tabs

Provides protection and electrical current to the switches that control the optional trim tabs.

Interior Lights

Provides protection and electrical current to the switch that activates the head and storage compartment lights.

Water Pump

Provides protection and electrical current to the switch located in the battery switch panel that activates the pump for the fresh water system. A pressure switch automatically controls the water pump when the system is activated and properly primed.

Bilge Pump

Provides protection and power for the automatic float switch on the aft bilge pump. This "push to reset" breaker is always supplied current when the batteries are connected. Another breaker in the main DC breaker panel provides circuit protection for the manual switch.

Sump Pump

Provides protection and power for the automatic float switch in the shower sump pump. This "push to reset" breaker is always supplied current when the HOUSE battery switch is activated.

FWD Bilge Pump

Provides protection and power for the automatic float switch on the forward bilge pump. This "push to reset" breaker is always supplied current when the batteries are connected. Another breaker in the main DC breaker panel provides circuit protection for the manual switch.

Ignition

Provides protection and electrical current to the engine ignition switch.

Stereo

Provides protection and electrical current to the stereo located in the compartment on the starboard side of the cockpit.



288SS Battery Switch Panel, Circuit Protection & Switches

Arch

Provides protection and electrical current to the switch that activates the lights in the arch that illuminate the cockpit.

12V Recept

Provides protection and electrical current to the 12 volt accessory receptacle.

Cockpit Fridge

Supplies 12-volt electrical current directly to the optional cockpit refrigerator when AC current is not being used.

Macerator

Provides protection and electrical current to the holding tank monitor and the optional macerator pump switch in the head compartment.

Windlass Circuit Breaker

A heavy duty circuit breaker that provides protection and power for windlass relay. This breaker is supplied current when the battery selector switch is activated. If the circuit breaker is tripped by an overload, a yellow lever will be exposed near the center of the breaker. Reset the breaker by raising the lever until it locks in the vertical position.

Engine Main Breakers

The primary circuits for the engine is protected by heavy duty, "push to reset" breakers on each engine. They are supplied power whenever the engine battery switches are on. Refer to the engine owner's manual for information on the location and operation of the engine circuit breakers.

328SS Battery Switch Panel Breakers

The following is a description of the accessories controlled by the “push to reset” and main DC breakers in the 328SS battery switch panel.

House Charge

Provides protection for the battery charger output wire that supplies DC charging current to the HOUSE battery.

Port Charge

Provides protection for the battery charger output wire that supplies DC charging current to the PORT ENGINE battery.

STBD Charge

Provides protection for the battery charger output wire that supplies DC charging current to the STARBOARD ENGINE battery.

Cabin Pump

Provides protection and electrical current to the switch that activates the pump for the fresh water system. A pressure switch automatically controls the water pump when the system is activated and properly primed.

Cabin Main

The primary circuit for the cabin DC breaker panel is protected and powered by this circuit breaker. Other circuit breakers located in the cabin DC breaker panel protect the individual DC circuits. This “push to reset” breaker is supplied current when the HOUSE battery switch is activated.

Helm Main

The primary circuit for the main DC panel near the helm is protected and powered by this circuit breaker. Other circuit breakers located in the main DC breaker panel protect the individual DC circuits. This “push to reset” breaker is supplied current when the HOUSE battery switch is activated.

Helm ACCY Panel

The primary circuit for the helm accessory breaker panel near the helm is protected and powered by this circuit breaker. Other circuit breakers located in the helm accessory breaker panel protect the individual circuits. This “push to reset” breaker is supplied current when the HOUSE battery switch is activated.



328SS Battery Switch Panel, Circuit Protection & Switches

Stereo Amp

A “push to reset” circuit breaker that provides protection and power for the stereo amplifier for the boat speaker system. This breaker is supplied current when the battery selector switch is activated.

Aft Seat

Provides protection and electrical current to the switch that activates the switch that controls the motor that raises and retracts the aft seat backrest above the engine compartment in the battery switch panel.

Bilge Pump

Provides protection and power for the automatic float switch on the aft bilge pump. This “push to reset” breaker is always supplied current when the batteries are connected. Another breaker in the main DC breaker panel provides circuit protection for the manual switch.

CO Monitor

Supplies 12-volt electrical current to the carbon monoxide detector in the cabin. This is a “push to reset” breaker that is normally on, unless tripped by an overload, when the House battery switch is activated. It should be checked, and the power indicator on the carbon monoxide detectors should be lit whenever someone is occupying the cabin. If the breaker has tripped, it indicates that there is a problem with the carbon monoxide detector, the breaker, or the wiring from the breaker panel to the detector. Always determine the cause of the problem and correct it before resetting the breaker.

Port Ignition

Provides protection and power for the computer memory for the port engine. This “push to reset” breaker is always supplied current when the batteries are connected.

Memory

Provides protection and continuous power for the stereo and electronics memory. This “push to reset” breaker is always supplied current when the batteries are connected.

Emergency Pump

Provides protection and power for the automatic float switch on the emergency bilge pump in the engine compartment bilge. This “push to reset” breaker is always supplied current when the batteries are connected. Another breaker in the helm breaker panel provides circuit protection for the manual switch.

Sump Pump

Provides protection and power for the automatic float switch in the shower sump pump. This “push to reset” breaker is always supplied current when the HOUSE battery switch is activated.

Stbd Ignition

Provides protection and power for the computer memory for the starboard engine. This “push to reset” breaker is always supplied current when the batteries are connected.

Windlass Circuit Breaker

A heavy duty circuit breaker that provides protection and power for windlass relay. This breaker is supplied current when the battery selector switch is activated. If the circuit breaker is tripped by an overload, a yellow lever will be exposed near the center of the breaker. Reset the breaker by raising the lever until it locks in the vertical position.



288SS & 328SS Helm Accessory Breaker Panel

Engine Main Breakers

The primary circuits for the engine is protected by heavy duty, “push to reset” breakers on each engine. They are supplied power whenever the engine battery switches are on. Refer to the engine owner’s manual for information on the location and operation of the engine circuit breakers.

288SS/328SS Helm Accessory Breaker Panel

The helm accessory circuit breaker is located in the cockpit near helm. The following is a description of the accessories supplied power and protected by the “push to reset” breakers in the panel.

Electronics

Provides protection and electrical current to the electronics circuit at the helm.

VHF

Provides protection and electrical current to the circuit for the VHF radio at the helm.

Acc

Reserved for additional 12 volt equipment.

Spotlight

Provides protection and electrical current to the electronics circuit at the helm.

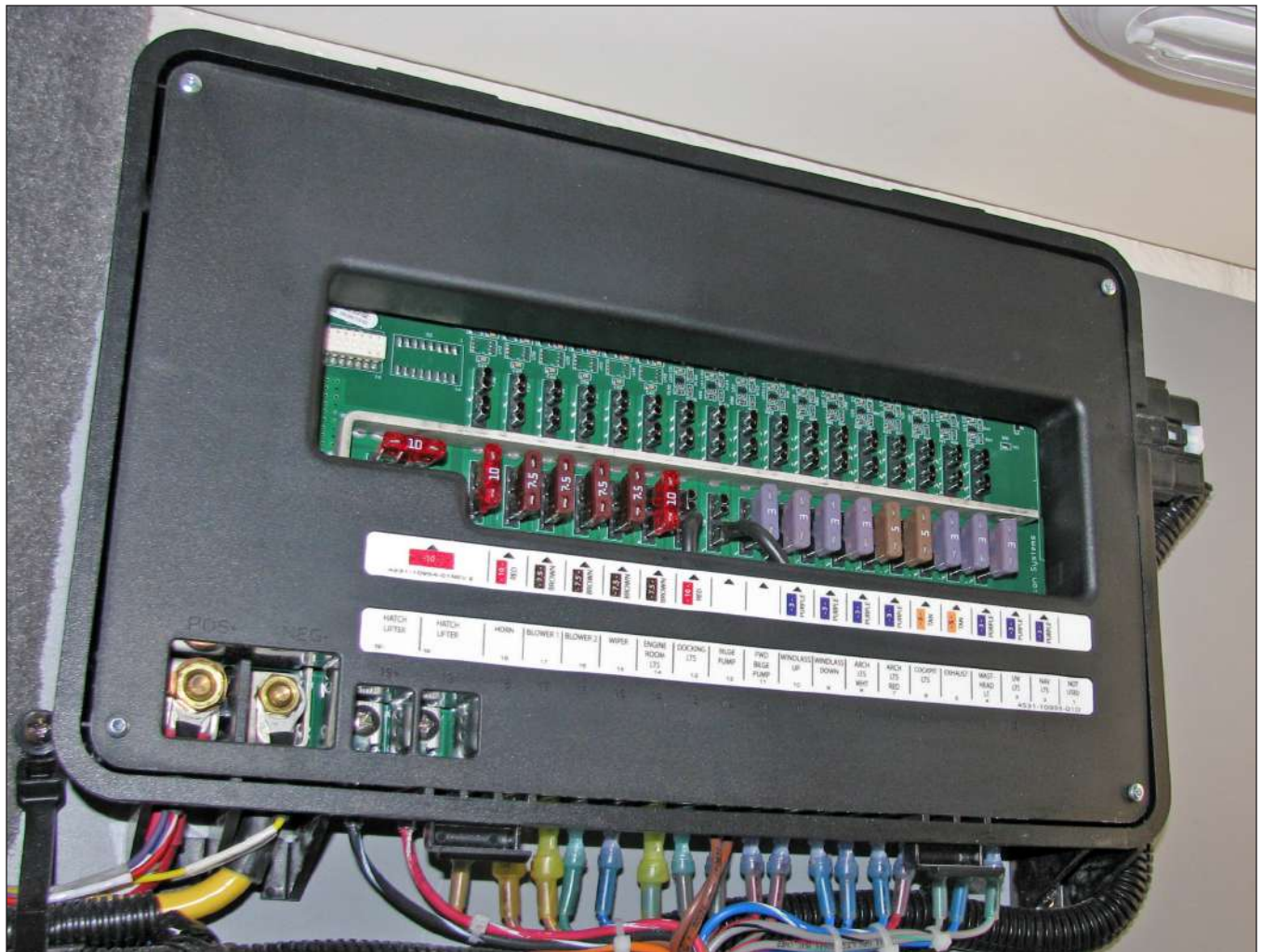

Power Management Module with Cover Removed Showing Fuse Panel

288SS/328SS Digital Switching System Circuit Protection

Accessories circuits activated by the digital switches in the helm are protected by spade type fuses located in the power management module in the compartment forward of helm station.

The fuses are color coded to indicate the amperage of the fuse. The amperage rating is also clearly printed on the fuse housing and the labels on the power management module. Never replace a blown fuse with a fuse of a higher amperage and/or a different color.



Power Management Module with Cover On

The following is a description of the accessory circuits protected by fuses in the power management module.

Hatch Lifter UP/Down

Protects the up and down circuits for the engine hatch actuator.

Horn

Protects the circuit for the horn.

Blower 1

Protects the circuit for Blower 1 in the engine compartment.

Blower 2

Protects the circuit for Blower 2 in the engine compartment.

Wiper

Protects the circuit for windshield wipers.

Engine Room LTS

Protects the circuit for the lights in the engine room.

Docking LTS

Protects the circuit for the docking lights in hull at the bow.

Bilge Pump

Protects the manually activated circuit for the aft bilge pump in the engine room.

FWD Bilge Pump

Protects the manually activated circuit for the forward bilge pump.

Windlass UP

Protects the up circuit that activates the windless to raise the anchor.



Typical Digital Helm Switch Panel

Windlass Down

Protects the down circuit that activates the windless to lower the anchor.

Arch LTS WHT

Protects the circuit for the white lights in the arch that illuminate the cockpit.

Arch LTS RED

Protects the circuit for the red lights in the arch that illuminate the cockpit.

Cockpit LTS

Protects the circuit for the lights that illuminate the cockpit sole.

Exhaust

Protects the circuit that activates the diverter valves in the exhaust system.

Masthead LT

Protects the circuit for the anchor light.

UW LTS

Protects the circuit for the underwater lights that illuminate the water around the boat.

Nav LTS

Protects the circuit for the navigation lights.

328SS Cabin DC Breaker Panel

The cabin DC breaker panel is located on the forward side of the cabin in a cabinet near the companionway. The following is a description of the accessories controlled by the breakers in the cabin DC breaker panel:

DC Volt Meter

Indicates the voltage available to the panel from the House Battery.

Water Tank Level Gauge

Indicates the water level in the fresh water tank whenever the house battery is activated.

Main

Supplies the 12-volt current to the DC accessory breakers and protects the panel from an overload.

TV/DVD

Supplies 12-volt electrical current to the TV's and DVD players.

Cabin Lighting

Supplies 12-volt electrical current to the cabin light switches.

Water Pump

Supplies 12-volt electrical current directly to the fresh water pump pressure switch located on the pump. The pressure switch automatically controls the water pump when the system is activated and properly primed. It is protected by the circuit breaker in the panel and an automatically resetting breaker on the pump motor.

Cabin Refrigerator

Supplies 12-volt electrical current directly to the refrigerator in the galley when AC current is not being used.

Cockpit Refrigerator

Supplies 12-volt electrical current directly to the optional cockpit refrigerator when AC current is not being used.

Head System

Supplies electrical current directly to the vacuum pump on the electric head system. A vacuum switch on the pump automatically controls the pump and maintains proper vacuum in the system.



Cabin DC Electrical Panel



DC Electrical System W/ Optional Generator Control Panel

Stereo

Supplies 12-volt electrical current to the stereo located in the cabinet above the dinette.

Macerator

Supplies electrical current to the holding tank monitor and the macerator pump.

12V ACC

A "push to reset" breaker that is reserved for additional 12-volt equipment.

Generator Operation Panel (Optional)

Located in the DC panel in the cabin. There are two switches. One switch activates the blowers and one switch controls the starting, running, and stopping of the optional generator.

6.7 AC Battery Charging System (Single Engine Boats)

General

A 120 volt AC battery charging system is an available option for models not equipped with a 120 volt AC electrical system.

The battery charging system is fed 120 volt AC current by a power cable connected to a shore side outlet and the shore power inlet located in the stern near the transom door. It is wired totally separate from the 12 volt DC system and charges all batteries simultaneously when connected.

NOTICE:

The power cord used for the battery charger is not equipped with lock rings on the shore side or boat connector plugs. The battery charger has integrated reverse polarity protection and the circuit is not equipped with a reverse polarity light.



AC Battery Charger System Inlet Connection

tery charger is not working, turn off the shore disconnect switch and remove the cable. Contact your dealer or a qualified electrician to find and correct the problem.

⚠ DANGER ⚠

TO REDUCE THE POSSIBILITY OF AN ELECTRICAL SHOCK, IT IS IMPORTANT THAT THE AC GROUND SYSTEM IS FUNCTIONING PROPERLY AND THAT A PROPER CONNECTION EXISTS BETWEEN THE SHORE POWER CORD AND THE SHORE POWER INLET AND THE OUTLET GROUND CIRCUITS. IF THERE IS ANY DOUBT ABOUT THE INTEGRITY OF THE GROUND CIRCUIT, A QUALIFIED MARINE ELECTRICIAN SHOULD BE CONTACTED IMMEDIATELY AND THE SHORE POWER SHOULD BE DISCONNECTED UNTIL THE NECESSARY REPAIRS ARE COMPLETED.

ELECTRICAL SHOCKS FROM 120 VOLT CIRCUITS CAN CAUSE SEVERE INJURY OR DEATH. TO REDUCE THE RISK OF ELECTRICAL SHOCK IN WET WEATHER, AVOID MAKING CONTACT WITH THE SHORE CABLE OR MAKING A CONNECTION TO A LIVE SHORE OUTLET. NEVER SPRAY WATER ON ELECTRICAL CABLES WHILE WASHING DOWN DECKS.

⚠ WARNING ⚠

DO NOT ATTEMPT TO CORRECT THE WIRING YOURSELF. ELECTRIC SHOCK CAN CAUSE SEVERE INJURY OR EVEN DEATH. ALWAYS HAVE A QUALIFIED ELECTRICIAN CHECK WIRING.

KEEP CHILDREN AWAY FROM ANY ELECTRICAL CABLES OR EQUIPMENT.

⚠ WARNING ⚠

UNDETECTED FAULTS IN THE AC BATTERY CHARGING SYSTEM COULD CAUSE THE WATER AROUND THE BOAT TO BECOME ENERGIZED. THIS COULD CAUSE A SEVERE SHOCK OR EVEN DEATH TO SOMEONE IN THE WATER NEAR THE BOAT. NEVER SWIM OR ALLOW SWIMMING AROUND THE BOAT WHEN THE BATTERY CHARGING SYSTEM IS ACTIVATED BY THE SHORE POWER CONNECTION.

Recommended Procedure For Making a Shore Connection

If the dockside outlet includes a disconnect switch, turn it to the "OFF" position. To avoid strain on the cable make sure it has more slack than the mooring lines. Dress the cable so that it cannot be damaged by chafing between the boat and the dock. Make sure the cable does not come in contact with the water. Then connect the cable in the plug inlet making sure the connection plug includes a three-prong plug with a ground wire. Turn the dockside disconnect switch or circuit breaker to the "ON" position and check that the battery charger is operating properly. If the bat-

Disconnecting procedure for shore power connection

Turn the disconnect switch on the dockside outlet to the "OFF" position.

Disconnect the cable from the dockside outlet and replace the outlet caps. Disconnect the cable from the boat and replace the inlet cap. Store cable.

6.8 Battery Charger

A battery charger mounted in the engine compartment is optional equipment on some models. AC electrical current is supplied either directly to the automatic battery charger or by a circuit breaker in the cabin AC breaker panel. The battery charger automatically charges and maintains the 12 volt batteries simultaneously when activated. It is fully automatic and equipped with led lights to indicate the state of charge for each battery and/or a voltmeter in the cabin DC breaker panel on 328SS models.

Charging for the batteries also can be monitored by using the voltmeter in the engine gauge cluster. With the charger activated, turn the ignition key switch for each engine to the "ON" position. DO NOT START THE ENGINE. Then read the voltage on the volt meter. If the batteries are in good condition and charging properly, the voltmeter will indicate between 12 and 14.5 volts. If the reading is below 12 volts, then the battery is not accepting a charge or the charger is not working properly. Always turn the ignition switches off immediately after the monitoring is complete.

The wires that supply DC charging current to the batteries are protected by an internal fuse in the battery charger and external fuses, one for each battery output wire, located near each battery. The external fuses protect the DC charging circuit from the batteries to the charger. The internal fuses in the charger protect the DC charging circuit from the charger to the batteries. See the battery charger manual for more information.

6.9 DC To AC Power Inverter (328SS) Power Inverter General

A 12 volt DC to 120 volt AC power inverter is available as optional equipment on some models. A remote switch panel controls the inverter that converts 12 DC electrical power from the batteries to 120 volt AC power for the optional cockpit grill. Inverters draw a substantial amount of current from the house batteries. It takes approximately 20 amps 12-volt DC current to provide 2 amps 120 volt AC current. Therefore, you should only use the Bat' save mode when shore or generator AC power is not available to maintain the house batteries with the battery charger while the inverter is activated.

The ON/OFF switch turns the Inverter to ON or OFF. In the ON position, the Inverter/Fault LED



Typical Battery Charger

light will illuminate green. The inverter begins inverting and provides modified sine wave power. In this position the inverter will continue to supply AC power until the house batteries are depleted. The battery charger should be activated and maintaining the house battery whenever the inverter switch is in the ON position. In the OFF position the inverter draws no current from the battery.

Bat' Saver mode is the preferred setting, particularly when shore or generator AC power is not available to maintain the house Batteries. Bat' Saver mode allows the user to protect from draining down the entire power of the house battery and shuts the inverter off when the battery reaches a threshold of 11.7 volts, allowing the other DC accessories to continue to operate normally and preventing excessive drain on the battery. To use the Bat' Saver mode, turn the ON/OFF switch to the Bat' Saver mode.

Two indicator lights on the panel illustrate the operating status of the Inverter. When the inverter is on and supplying power normally the green light glows. The red "fault light" glows when there is a battery over voltage, low battery voltage, output overload or an over temperature condition in the inverter. Refer to the inverter operating manual for more information on the operation of the inverter.

6.10 120 Volt AC System (328SS)

328SS models are supplied 120 volt, 60 cycle current by a 30 amp shore power outlet at dockside or by an optional generator. It is wired totally separate from the 12 volt DC system and is equipped with an onboard isolation system.

A main circuit breaker that protects the circuit from the shore inlet to the cabin AC panel and an Equipment Leakage Circuit Interrupter (ELCI) are located in a panel in the rear of the boat. The Equipment Leakage Circuit Interrupter provides whole-boat ground fault protection (electrical shock protection from stray current) for the entire AC shore power system. Another main circuit breaker and breakers for each accessory circuit are located in the cabin AC panel.

The AC system can be fed by either the shore power inlet or by the optional generator. If your boat is equipped with a generator, main breakers in the AC panel are used to select the source of power desired, Shore Main or Generator Main. The AC main breakers must be switched to the OFF position before selecting a different power source.

All AC current is distributed to the AC accessories through individual circuit breakers located in the cabin AC panel. The main breakers protect the system from an overload and a reverse polarity light indicates any problems due to an improper shore power supply. All AC outlets in the cabin and cockpit are protected by ground fault interrupters to protect against electrical shock.

While moored dockside, 120 volt AC power should be utilized from dockside power, if available. A cord set is provided to supply power from the shore power outlet to the boat's 120 volt AC system.



328SS 30 AMP Shore Power Inlet Connection & Circuit Breaker



DANGER



TO REDUCE THE RISK OF ELECTRICAL SHOCK IN WET WEATHER, AVOID MAKING CONTACT WITH THE SHORE CABLE OR MAKING A CONNECTION TO A LIVE SHORE OUTLET. NEVER SPRAY WATER ON ELECTRICAL CABLES WHILE WASHING DOWN DECKS.



DANGER



TO REDUCE THE POSSIBILITY OF AN ELECTRICAL SHOCK, IT IS IMPORTANT THAT THE AC GROUND SYSTEM IS FUNCTIONING PROPERLY AND THAT A PROPER CONNECTION EXISTS BETWEEN THE SHORE POWER CORD, THE SHORE POWER INLET, THE BOAT BONDING SYSTEM AND THE OUTLET GROUND CIRCUITS. IF THERE IS ANY DOUBT ABOUT THE INTEGRITY OF THE GROUND CIRCUIT, A QUALIFIED MARINE ELECTRICIAN SHOULD BE CONTACTED IMMEDIATELY AND THE AC POWER SHOULD BE DISCONNECTED UNTIL THE NECESSARY REPAIRS ARE COMPLETED.

Recommended procedure for making a shore connection:

Turn the AC Shore Main breakers to the "OFF" position. If the dockside outlet includes a disconnect switch, turn it to the "OFF" position also.

To avoid strain on the cable make sure it has more slack than the mooring lines. Dress the cable so it cannot be damaged by chafing between the boat and the dock. Make sure the cable doesn't come in contact with the water and connect the cable to the boat inlet plug and then to the dockside outlet, making sure the connection plugs include a three-prong plug with a ground wire. Tighten the lock rings on both the shore and the boat connector plugs.

Turn the dockside disconnect switch or circuit breaker to the ON position. Then turn the circuit breaker at the boat inlet plug on and check for proper polarity. If reversed polarity has been achieved, the red reversed polarity indicator in the cabin AC panel will light. If this should happen, make sure the Shore Main breaker on the panel is in the "OFF" position and turn the dock power switch or breaker off. If the Shore Main light illuminates and the red Reversed Polarity light does not illuminate when power is supplied to the panel the polarity is correct and the AC main breaker can be moved to the "ON" position.

Check the ELCI panel in the engine compartment for faults. The green "POWER" LED should show steady illumination and the red "FAULT" LED should remain off. The ELCI trips and opens the main circuit when there is a ground fault condition. If the red LED is continuously illuminated the ELCI has tripped due to a ground fault condition. Some faults are self-clearing. Try resetting the ELCI once. If the green LED shows steady illumination and the ELCI does not trip again, the circuit is correct and activated.

If the reversed polarity light is lit or the ELCI continues to trip and the red "FAULT" LED is lit after being reset there is a problem with the AC electrical system and it is unsafe to use. Make sure the Shore Main breaker on the panel is in the "OFF" position and turn the dock power switch or breaker off. Disconnect the shore power supply cord from the boat and notify a qualified marine electrician to check the wiring and correct the problem.



DANGER



REVERSED POLARITY AND GROUND FAULT CONDITIONS WILL DAMAGE THE SYSTEM AND EXPOSE PASSENGERS TO ELECTROCUTION HAZARDS THAT WILL CAUSE SEVERE INJURY OR DEATH. THIS CONDITION COULD ALSO CAUSE A FIRE IN THE ELECTRICAL SYSTEM. NEVER OPERATE THE AC ELECTRICAL SYSTEM WITH REVERSED POLARITY OR A GROUND FAULT CONDITION.



WARNING



ELECTRIC SHOCK CAN CAUSE SEVERE INJURY OR EVEN DEATH. DO NOT ATTEMPT TO CORRECT THE WIRING YOURSELF. ALWAYS HAVE A QUALIFIED ELECTRICIAN CHECK WIRING.

KEEP CHILDREN AWAY FROM ANY ELECTRICAL CABLES OR EQUIPMENT AND ALWAYS USE GROUNDED APPLIANCES ON BOARD YOUR BOAT.

UNDETECTED FAULTS IN THE AC ELECTRICAL SYSTEM COULD CAUSE THE WATER AROUND THE BOAT TO BECOME ENERGIZED. THIS COULD CAUSE A SEVERE SHOCK OR EVEN DEATH TO SOMEONE IN THE WATER NEAR THE BOAT. NEVER SWIM OR ALLOW SWIMMING AROUND THE BOAT WHEN THE AC SYSTEM IS ACTIVATED BY THE SHORE POWER CONNECTION OR THE GENERATOR.

Disconnecting procedure for shore power connection:

Turn the Shore Main breaker on the AC panel to the "OFF" position. Turn the disconnect breaker on the dockside outlet to the "OFF" position.

Disconnect the cable from the dockside outlet and replace the outlet caps. Disconnect the cable from the boat and replace the outlet cap. Store cable.

Equipment Leakage Circuit Interrupter

The ELCI provides whole-boat ground fault protection (electrical shock protection from stray current) for the entire AC shore power system. The ELCI face plate in the engine compartment is equipped with TEST and RESET buttons. There are also two LED lights that indicate circuit status. When the 120 volt AC system is activated, the green "POWER" LED should show steady illumination and the red "FAULT" LED should remain off. The ELCI trips and opens the main circuit when there is a ground fault condition. If the red "FAULT" LED is continuously illuminated the ELCI has tripped due to a ground fault condition. Some faults are self correcting. If it trips, try resetting the ELCI once. If the green LED shows steady illumination and the ELCI does not trip again, the



328SS 120 Volt AC Panel

circuit is OK. If the ELCI continues to trip and the red LED is lit after being reset there is a problem with the AC electrical system and it is unsafe to use. Make sure all main breakers are turned off and notify a qualified marine electrician to check the wiring and correct the problem.

It is important that the ELCI is working properly to provide protection against electric shock. It should be tested at least once each month to ensure proper operation by pressing the TEST/RESET buttons in the faceplate. Refer the ELCI instructions for the testing procedure.

AC Accessory Breaker Panel

The AC panel is located in the cabin near the companionway door. The following is a description of the AC panel equipment and the breakers that protect the accessories:

AC Volt Meter

Indicates the voltage supplied to the panel. The voltage should be checked each time the AC system is activated. The AC system and accessories can be damaged by voltage that is below 105 volts or above 125 volts. You should monitor the volt-

age and never operate your AC electrical system if the voltage is below or above this range.

Shore Main and Generator Main Breakers

These breakers select the power source and protect the general distribution network. There is a main breaker for the shore circuit and the generator, if this option is installed. If your boat is not equipped with a generator, there will only be a SHORE MAIN breaker. If your boat is equipped with a generator, there will be SHORE and GENERATOR MAIN breakers with a sliding safety cover on the main breakers prevent activating circuits for the generator and shore circuit simultaneously. These breakers are very sensitive. The resulting power surge that occurs when connecting the dockside cord may cause the main breaker to trip. To avoid this surge, always turn the Shore Power main breaker to the "OFF" position before plugging or unplugging the shore power cord and the Generator Main breaker to the "OFF" position when starting the generator.

Care must be taken when operating the AC system from the generator or the shore power supply line. On some boats it may be possible to overload

the generator or shore power circuit if too many AC accessory breakers are activated. Too much amperage being supplied through the panel will cause the Shore Main or Generator breaker to trip and could damage the system. This is particularly important when operating the air conditioner and water heater. You should always be aware of the electrical load needed to activate accessories and manage the amperage being supplied so the load can be kept within safe limits. If you have any questions about managing the power in your boat, contact your Monterey dealer.

Reversed Polarity Lights

The red LED light indicates reverse polarity current supplied to the panel. This situation will cause the red light to remain lit. If reverse polarity is achieved, immediately turn off all cabin AC breakers and the dockside outlet breaker. Disconnect the power cable from the dockside outlet and notify a qualified marine electrician to check the dockside wiring.

Reverse Polarity Light Test Switch

There is a momentary switch located next to the reverse polarity light in the AC breaker panel. This switch is used to test the reverse polarity light to ensure that they are functioning. The light can be tested by depressing the switch whenever the AC system is activated. The reverse polarity light should be tested each time the AC system is activated. If the light does not illuminate when the switch is pressed, disconnect the shore power cable and notify a qualified electrician to check the light and the dockside wiring if necessary.

AC Panel Accessory Breakers Outlets

Supplies 120 volt AC electrical current to the cabin ground fault interrupter (G.F.I.) electrical outlets.

NOTICE:

All AC electrical outlets are provided with ground fault interrupts to protect against electric shock. These outlets should be tested periodically to ensure proper operation by pressing the test/reset buttons in the center of faceplate. G.F.I. outlets do not protect against short circuits and overloads. This is done by the outlet breakers on the AC panel.



WARNING



G.F.I. OUTLETS DO NOT PROVIDE 100% PROTECTION FROM ELECTRIC SHOCK. EVEN THOUGH GROUND FAULT INTERRUPTERS PROVIDE PROTECTION BY REDUCING EXPOSURE TIME FROM LINE TO GROUND SHOCK HAZARDS, IT IS STILL POSSIBLE TO RECEIVE AN ELECTRIC SHOCK FROM DEFECTIVE APPLIANCES OR POWER TOOLS AND MISUSED ELECTRICAL EQUIPMENT.

Water Heater

Supplies electrical current directly to the hot water heater circuit. A thermostat in the water heater control panel automatically controls the water temperature. Before operation, you must have water in the water heater. (See the water heater manual for details)

Battery Charger

Supplies electrical current directly to the automatic battery charger. The battery charger recharges and maintains the 12-volt batteries simultaneously when activated. It is fully automatic. See the battery charger manual for more information.

The charge to the engine batteries can be monitored by using the volt meters in the engine gauge cluster. To monitor the engine batteries, activate the charger and turn the engine battery switches on. Turn the ignition key switch for each engine to the "ON" position (**DO NOT START THE ENGINES**) and read the voltage on the volt meter for each engine. To monitor the house battery, activate the charger and turn the HOUSE battery switch ON. Read the volt meter in the cabin DC breaker panel. If the batteries are in good condition and charging properly, the volt meters will indicate between 12 and 14.5 volts. If the reading is below 12 volts, then the battery is not accepting a charge or the charger is not working properly. Always turn the ignition switches off immediately after the monitoring is complete. Refer to the battery charger manual for more information.

The wires that supply DC charging current to the batteries are protected by an internal fuse in the battery charger and 3 external breakers, one for each battery output wire, located in the engine compartment breaker panel near the battery switches. The external breakers protect the DC charging circuit from the batteries to the charger. The internal fuses in the charger protect the DC charging circuit from the charger to the batteries.

Cabin Refrigerator

Reserved for addition 120 volt AC equipment.

Cockpit Refrigerator / Ice maker (Optional)

Supplies AC electrical current directly to the optional cockpit refrigerator when AC power is available. See the refrigerator manual for more information.

Stove

Supplies 120 volt AC electrical current to the stove in the galley.

Microwave

Supplies 120 volt AC electrical current to the cabin ground fault interrupter (G.F.I.) electrical outlet that activates the Microwave.

Air Conditioner (Optional)

The shore 2 main breaker supplies electrical current to the air conditioner control panel located in the cabin and the air conditioner raw water pump.

NOTICE:

After a certain amount of time without water flow, the air conditioning unit will automatically power down.

Accessory

Reserved for additional AC equipment.

Additional AC Switch Panels and Breakers Shore Power Inlet Breaker

Located in the transom near the shore power inlet plugs. This breaker protects the AC system between the shore power inlet plug and the main AC panel.

6.11 Generator

The generator is optional equipment on the 328SS. It is activated by the house battery and is located in the engine compartment. The generator oil and coolant should be checked whenever you check the oil and coolant in the main engines.

There are two switches in the cabin DC panel that activate the generator. One switch activates the blowers and one switch controls the starting, running, and stopping of the optional generator. The generator can also be operated from a control panel on the generator. The circuit breakers that protect the generator AC and DC circuits are also on this panel. An owner operator's manual for the generator has been supplied with this manual. Please refer to it for details on the generator operation.



Optional Generator Control Panel In Cabin DC Panel

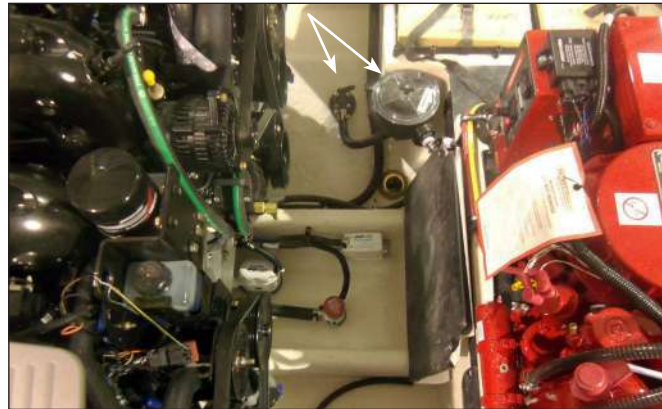

Generator Seawater Supply Thru-Hull Valve & Strainer

⚠ WARNING ⚠

ALWAYS CHECK THE ENGINE COMPARTMENT FOR GASOLINE FUMES AND RUN THE EXHAUST BLOWER FOR AT LEAST 4 MINUTES BEFORE STARTING THE GENERATOR. OPERATE THE BLOWERS WHILE THE GENERATOR IS OPERATING TO ENSURE ADEQUATE VENTILATION AND COOLING OF THE ENGINE COMPARTMENT.

The generator engine uses a closed cooling system with a seawater-cooled heat exchanger. There is an expansion tank for the engine coolant mounted near the generator. Make sure the fluid level in the expansion tank is kept between the maximum and minimum lines of the tank.

The seawater cooling system operates exactly like the cooling system on the main engines. It includes an inlet sea strainer that prevents debris in the seawater from entering the cooling pump. The strainer is located near the generator. It is important to check and clean the strainer regularly to ensure the seawater system can circulate enough water to provide cooling for the closed cooling and

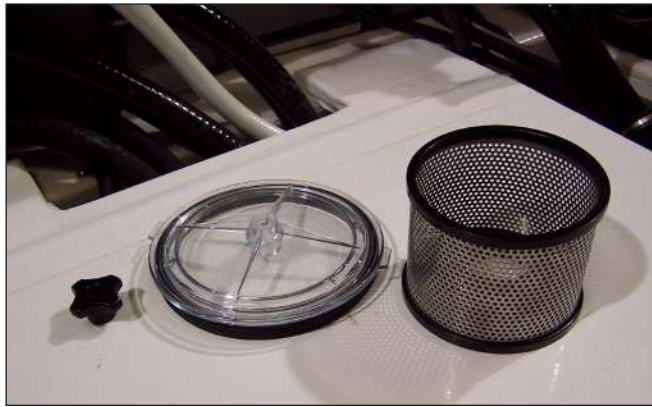

Sea Strainer Screen



Sea Strainer

exhaust systems on the generator. You should also check the exhaust port for water flow each time the generator is started. If there is no discharge within thirty seconds, shut down the generator and find and correct the problem.

NOTICE:

Generators consume DC electrical current and charge the house/generator battery just enough to compensate for the DC electrical current the engine requires to operate. Therefore, it is important to activate the battery charger to maintain the house and engine batteries whenever the generator is running.

NOTICE:

The generator may not be able to operate all 120 volt accessories at the same time. POWER MANAGEMENT PRACTICES may need to be observed depending on the AC power load.

Cleaning the Sea Strainers

- Turn off the engines and generator.
- Close the generator water intake valve.
- Open the top of the strainer and remove the screen.
- Thoroughly flush the screen and the inside of the strainer to remove foreign matter.
- Lubricate the seal.
- Reassemble the strainer making sure that all fasteners are tight.
- Open the intake valve.



Sea cock

- Start the generator and inspect the strainer for leaks.

The generator fuel system is equipped with a water separating fuel filter and operates much like the fuel system for the main engines. Please refer to the Fuel System chapter for more information on generator fuel system.

You also should read the generator owner's manual for detailed information on the safe operation and maintenance of the generator.

⚠
DANGER
⚠

GENERATOR ENGINES PRODUCE CARBON MONOXIDE WHICH IS A LETHAL, TOXIC GAS THAT IS COLORLESS AND ODORLESS. IT IS A DANGEROUS GAS THAT WILL CAUSE DEATH IN CERTAIN LEVELS. ONLY OPERATE THE GENERATOR IN WELL VENTILATED AREAS AND NEVER OPERATE THE GENERATOR WHILE YOU ARE SLEEPING.



6.12 Bonding System

Your boat is equipped with a bonding system that interconnects all underwater metal hardware and thru-hull fittings to ensure that they are of the same electrical potential. Anodes are attached to the bonding system at the transom plates, trim tab planes and outdrives. The anodes deteriorate before the other metals, thereby protecting the underwater metals from galvanic corrosion or stray electrical current. Since the anodes are sacrificial, it is important to monitor them and replace the anodes when they have deteriorated to 50 - 75% of their original size. The bonding system is connected to the DC ground and the earth ground wire for the AC electrical system. It provides a path to the safety earth ground in the event of a fault in the shore earth ground connection and when the boat is away from the dock.

6.13 Electrical System Maintenance

12 Volt DC Electrical System Maintenance

At least once a year, spray all exposed electrical components behind the helm and in the plugs, with a protector. Exterior light fixture bulbs should be removed and the metal contact areas coated with a non-water soluble lubricant like Teflon or silicone grease. The sockets should be sprayed with a protector. Care must be taken not to get any oil or grease on the glass portion of the bulbs as this will cause the bulb to overheat and burn out.

	WARNING	
<p>WHEN REPLACING LIGHT BULBS IN MARINE LIGHT FIXTURES, ALWAYS USE A BULB WITH THE SAME RATING AS THE ORIGINAL. USING A DIFFERENT BULB COULD CAUSE THE FIXTURE TO OVERHEAT AND MELT OR SHORT CIRCUIT.</p>		

Inspect all wiring for proper support, sound insulation, and tight terminals, paying particular attention to portable appliance cords and plugs.

Check all below deck wiring to be sure it is properly supported, that the insulation is sound, and that there are no loose or corroded terminals. Corroded terminals should be thoroughly cleaned with sandpaper or replaced, tightened securely and sprayed with a metal and electrical protector.

Inspect all engine wiring.



Check the electrolyte level in the batteries regularly and add distilled water as necessary. If the batteries are frequently charged by the automatic battery charger, the electrolyte level will have to be checked more often. The correct fluid level in the cells is usually approximately 1/4 to 1/2 inch above the plates. If fluid is needed, fill to the proper level with distilled water. **Do not over fill!**

NOTICE:
Some batteries are sealed and do not require or allow the inspection of the electrolyte.

Keep the battery tops clean and dry. Dirt and water can conduct electricity from one post to the other causing the battery to discharge.

The battery posts should be kept free of corrosion. Remove the cables and clean the posts and cable clamps with a battery post cleaner or sandpaper as required. Coating the battery posts and cable clamps with Teflon or silicone grease will protect them and reduce corrosion.

Battery cables, both hot and ground, must be replaced when they show signs of corrosion or fraying. Deteriorated cables cause a considerable voltage loss when high currents are drawn, such as starting the engine.

	DANGER	
<p>A BATTERY CAN EXPLODE IF A FLAME OR SPARK IGNITES THE HYDROGEN GAS THE BATTERY EMITS WHILE BEING CHARGED. NEVER USE AN OPEN FLAME IN THE BATTERY STORAGE AREA. AVOID STRIKING SPARKS NEAR THE BATTERY.</p>		

AC Electrical System Maintenance

Periodically inspect all wiring for nicks, chafing, brittleness, improper support, etc. Examine each shore power cord closely for cracks in the insulation and corrosion in electrical connectors. Spraying receptacles and electrical connections with an electrical contact cleaner or a metal and electrical protector will reduce corrosion and improve electrical continuity.

Inspect all wiring for proper support, sound insulation, and tight terminals, paying particular attention to portable appliance cords and plugs.

The entire AC circuitry, especially the shore power cords, should be seasonally tested for proper continuity by an experienced electrician. This will detect any shorts, open wires, or ground faults. Ground fault interrupts should be tested periodically to ensure proper operation by pressing the test/reset buttons in the center of face plate. The polarity indicator system also should be inspected for proper operation.

Generator Maintenance

The engine maintenance required on the generator is similar in many ways to the main engines. The most important factors to the generator's longevity are proper ventilation and maintenance of the fuel system, ignition system, cooling system, lubrication system and the AC alternator.

Maintenance schedules and procedures are outlined in your generator owner's manual. They should be followed exactly.



WARNING



CORROSION ALLOWED TO BUILD ON THE ELECTRICAL CONNECTORS CAN CAUSE A POOR CONNECTION RESULTING IN SHORTS, GROUND FAULTS OR POOR GROUND CONNECTIONS. ELECTRICAL CONNECTORS SHOULD BE CHECKED AT LEAST ANNUALLY AND CLEANED AS REQUIRED. DO NOT ALLOW CORROSION TO BUILD ON CONNECTIONS.



WARNING



ELECTRIC SHOCK CAN CAUSE SEVERE INJURY OR EVEN DEATH. THE AC AND DC ELECTRICAL SYSTEMS ALWAYS SHOULD BE DISCONNECTED FROM THE POWER SOURCE BEFORE INSPECTING OR SERVICING THE SYSTEM. NEVER SERVICE ANY COMPONENT OF AN ELECTRICAL SYSTEM WHILE IT IS ENERGIZED.

FRESH WATER SYSTEM

7.1 General

The fresh water system is optional on most models and standard equipment others. It consists of a potable water tank, distribution lines and a distribution pump. 328SS models are also equipped with a water heater. The pump is equipped with an automatic pressure switch and is located in the engine compartment or near the water tank. The water tank is located either in the engine compartment or in the bilge below the cockpit. The tank is filled through a labeled deck plate located on the gunnel or at the rear of the boat near the swim platform.



WARNING



DO NOT FILL SYSTEM WITH ANYTHING OTHER THAN WATER. SHOULD THE SYSTEM BECOME CONTAMINATED WITH FUEL OR OTHER TOXIC FLUIDS, COMPONENT REPLACEMENT MAY BE NECESSARY.



WARNING



WATER AND WASTE PUMPS ARE NOT DESIGNED TO PUMP FUEL AND A FIRE OR EXPLOSION COULD RESULT. DO NOT CONFUSE FUEL FILL DECK PLATES WITH THE WATER OR WASTE FILL DECK PLATES. THESE PLATES ALSO ARE LABELED ACCORDINGLY. IF GASOLINE OR DIESEL FUEL IS ACCIDENTALLY PUMPED INTO THE WATER OR WASTE TANK, DO NOT ATTEMPT TO PUMP IT OUT YOURSELF. CONTACT YOUR DEALER OR THE MONTEREY BOATS CUSTOMER SERVICE DEPARTMENT FOR ASSISTANCE IN HAVING THE FUEL PROFESSIONALLY REMOVED AND COMPONENTS OF THE FRESH WATER SYSTEM REPLACED AS NECESSARY.

7.2 Fresh Water System Operation

Fill the water supply tank slowly through the labeled deck plate. After filling the water tank, partially open all faucets. The Water System/Pump switch in the helm, the battery switch panel or the circuit breaker on the cabin DC panel should be on. Allow the pump to run until all of the air is purged from the system and a steady stream of water is flowing from each outlet. Next, turn off the faucets one by one. As the pressure builds, the pump will automatically shut off.



Fresh Water Fill

When properly primed and activated the water system will operate much like the water system in a home. An automatic pressure sensor keeps the system pressurized. If the system has been recently filled or has not been used for an extended period, air bubbles may accumulate at the pump and the system may have to be reprimed.

Whenever the boat is left unattended, the Water Pump breaker or switch should be placed in the "OFF" position.



CAUTION



DO NOT ALLOW THE FRESH WATER PUMP TO RUN DRY. THE FRESH WATER PUMP WORKS ON DEMAND AND WILL NOT SHUT OFF AUTOMATICALLY WHEN THE TANK IS EMPTY. THIS CAN RESULT IN DAMAGE TO THE PUMP. ALWAYS TURN THE WATER PUMP BREAKER OFF WHEN THE FRESH WATER SYSTEM IS NOT IN USE.

7.3 Water Heater (328SS)

The water heater is located in the engine compartment. It has a 120 volt element that is thermostatically controlled at the heater and activated by a circuit breaker located in the cabin 120 volt panel. The water heater is also equipped with a heat exchanger that is plumbed to the water

cooling system on one of the engines. The heat exchanger will heat the water in the hot water tank whenever that engine is operating.

Plumbing the heat exchanger to an engine is standard on Monterey boats. For highest efficiency, the engine heat exchanger is of the single wall type. The fresh water supply could become contaminated with engine coolant if the heat exchanger in the water heater fails and the engine is equipped with the optional fresh water cooling system.



328SS Cockpit Shower Head & Shower Water Connection

WARNING

MOST ENGINE COOLANT IS TOXIC AND CAN CAUSE SERIOUS INJURY OR DEATH IF IT CONTAMINATES THE FRESH WATER SUPPLY AND SOMEONE DRINKS THE WATER. NEVER DRINK THE WATER FROM THE FRESH WATER SYSTEM FAUCETS WHEN THE ENGINE HEAT EXCHANGER IS ACTIVATED IN THE WATER HEATER.

A high pressure relief valve protects the system from excessive pressure. Always make sure all air is purged from the water heater and lines before activating the water heater breaker. Refer to the water heater owner's manual for additional information.

CAUTION

DO NOT SUPPLY CURRENT TO AN EMPTY WATER HEATER. DAMAGE TO THE HEATER WILL RESULT. THE SYSTEM MUST BE FILLED AND PRIMED BEFORE USING THE WATER HEATER.

7.4 Shore Water Connection (328SS)

The shore water connection allows the direct connection of the water system to a shore side water supply. This provides the system with a constant supply of fresh water and minimizes the pressure pump operation. A female inlet fitting is mounted in the stern near the transom door. A pressure reducer is installed in the system along with two check valves. One check valve keeps water from running out of the shore water inlet fitting when the pressure pump operates. The second provides protection for the pressure pump when the shore water is connected.

To use shore water, connect a hose from the shore water faucet to the shore water fitting located in the transom storage compartment. Next, turn on the shore water. The pressure pump will not

run and the water in the boat's water tank will not be used.

NOTICE:
The water tank will not be filled by connecting to shore water.

CAUTION

DO NOT MODIFY OR CHANGE THE SHORE WATER INLET CONNECTOR WITH ANOTHER TYPE WITHOUT CONSULTING MONTEREY BOATS CUSTOMER SERVICE OR YOUR DEALER. THE USE OF THE WRONG TYPE OF INLET CONNECTOR CAN DAMAGE THE FRESH WATER SYSTEM.

WARNING

A SHORE WATER CONNECTION PROVIDES AN UNLIMITED SUPPLY OF WATER THAT COULD SINK THE BOAT. YOU SHOULD MONITOR THE SYSTEM FOR LEAKS WHEN IT IS CONNECTED AND ALWAYS TURN THE SHORE WATER SUPPLY VALVE OFF WHEN LEAVING THE BOAT UNATTENDED.

7.5 Shower Operation

There is a shower located in the head compartment on 328SS and at the transom on the port side, near the transom door. Each shower has a retractable shower head with an on/off valve. 328SS models also have hot and cold water.

Make sure the Water System/Pump switch or circuit breaker is on, then turn the water on. If your boat water system equipped with a water heater, adjust the hot and cold water faucet until the desired temperature is obtained. Some minor variations in the water temperature may occur as the pressure pump cycles. To conserve water, use

the valve on the shower head to turn the water on and off as you shower.

Shower water is drained from the 328SS head compartment by a sump pump system located in the bilge. An automatic float switch in the shower sump controls the pump. The pump is protected by the shower sump pump circuit breaker in the battery switch breaker panel. After showering, let the cold water flow for a period of time to flush the drainage system of soap residue. It is essential that the shower drain strainer is cleaned regularly and the sump is inspected periodically for accumulated debris that needs to be removed.

7.6 Fresh Water System Maintenance

Information and owner's manuals supplied with water system components is included with this manual. Refer to this information for additional operation and service data.

The following items should be done routinely to maintain your fresh water system:

- Periodically remove and clean the water strainer located near the intake side of the fresh water pump.
- Remove the filter screens from the faucet spouts and eliminate any accumulation of debris. A build up of debris can cause the pump to cycle excessively.
- Periodically remove the lid on the shower sump assembly located in the bilge on 328SS models. Clean debris from the sump and flush with clean water.
- Periodically spray the pumps and metal components with a metal protector.
- The batteries must be properly maintained and charged. Operating the pressure pump from a battery with a low charge could lead to pump failure.
- Add a commercially available potable water conditioner to the water tank to keep it fresh.

NOTICE:

The fresh water system must be properly winterized prior to winter lay-up. Refer to the section on winterizing for more information.



Cockpit Shower Head & Valve



Typical Water Pump & Strainer

Sanitizing the Fresh Water Tank

The fresh water system should be sanitized if it has not been used for a long period or you are unsure of the quality of the water in the system.

The following steps can be used to sanitize the system:

- Activate the system, open all hot and cold faucets and pump out as much water as you can.
- Make a chlorine solution by mixing two ounces of household chlorine bleach in a gallon of water. This mixture will treat approximately fifteen gallons. If the water tank on your boat is larger or smaller than 15 gallons, then adjust the mixture accordingly. Always mix the chlorine with water in a separate container first and never add straight chlorine to the fresh water tank.
- Fill the water tank half full with fresh water, then pour the mixture into the water tank and top off the tank.

- Activate the system and allow the water to run for about one minute at each faucet. Let the treated water stand for 4-6 hours.
- Drain the system by pumping it dry and flush with several tank fulls of fresh water.
- The system should now be sanitized and can be filled with fresh water. If the chlorine smell is still strong, it should be flushed several more times with fresh water.

NOTICE:

The quality of the water in marine fresh water systems can be questionable. We recommend that you avoid using the water from the fresh water system for drinking and cooking. You should only use bottled water for these purposes.

RAW WATER SYSTEM

8.1 General

In the raw or seawater systems, all water pumps are supplied by hoses connected to ball valves and thru-hull fittings located in the in the bilge. Always make sure the ball valves are open before attempting to operate any component of the raw water system.

An optional air conditioning system is available on 328SS models. The air conditioner uses a 120 volt AC seawater supply pump. This is the only 120 volt AC pump in the system and it is automatically activated when the air conditioning or heating system is in use.

Priming the System

The intake for the air conditioner seawater pump is equipped with a scoop and ball valve. If the pump runs but will not prime after cleaning the strainer or at the time of launching, make sure the valve is open. If the pump still won't prime, it may be air locked. Make sure the valve is open and run the boat at or above 15 M.P.H. The water pressure from the scoop will force the trapped air through the pump and allow it to prime. If this procedure doesn't work, contact your Monterey or Marine Air dealer.

Closing the thru-hull ball valves before the boat is hauled from the water will help to eliminate air locks in raw water systems.

NOTICE:

It may be necessary to reprime the raw water system if the system is not used for an extended period and at the time of launching.

8.2 Air Conditioning (328SS)

The optional air conditioner is self-contained and seawater cooled. A 12-volt DC or 120-volt AC centrifugal raw water pump, depending on the options selected for your boat, supplies seawater that cools the condensing unit as it circulates through the system and is discharged overboard. The pump is located in the engine compartment bilge. It is activated whenever the air conditioning system is operating.



Air Conditioner Pump, Strainer & Thru-Hull Valve

Seawater is supplied to the pump from a thru-hull fitting located in the hull near the pump. A sea strainer between the pump and thru-hull fitting protects the system from contaminants that could damage the pump or the air conditioning system. Make sure the seawater pump receives adequate seawater by periodically cleaning the sea strainer basket.

Cleaning the Sea Strainer

- Turn the air conditioner off at the control panel. Then turn the air conditioning breaker in the AC or DC panel off.
- Close the water intake valve.
- Open the top of the strainer and remove the screen.
- Thoroughly flush the screen and the inside of the strainer to remove foreign matter.
- Lubricate the seal.
- Reassemble the strainer making sure that all fasteners are tight.
- Open the intake valve.
- Activate the air conditioner and inspect the strainer for leaks.

- If the system will not prime, follow the procedure for priming the system in this chapter.

You should refer to the air conditioner owner's manual for more information on the operation and maintenance of the air conditioner.



8.3 Raw Water System Maintenance

The following items should be done routinely to help maintain your raw water system:

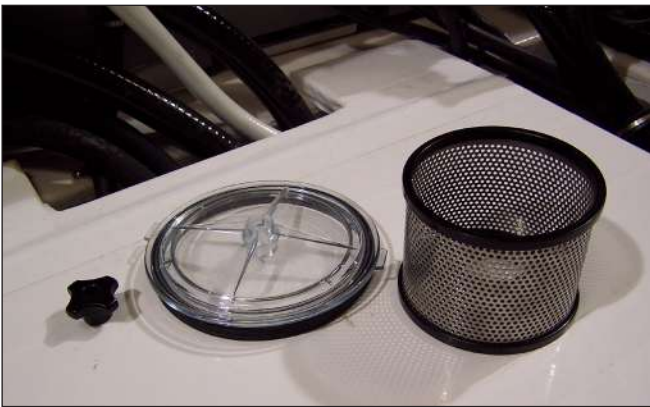
- Check hoses, particularly the seawater supply lines, for signs of deterioration.
- Remove and clean the seawater strainer for the air conditioner as required.
- Spray pumps and thru-hull valves with a protective oil periodically.
- Operate all thru-hull valves at least once a month to keep them operating properly.



Air Conditioner Sea Strainer Screen

	CAUTION	
SHOULD A HOSE RUPTURE, TURN THE PUMP OFF IMMEDIATELY. ALWAYS CLOSE THE THRU-HULL VALVE WHEN PERFORMING MAINTENANCE ON A SEAWATER PUMP.		
THE RAW WATER SYSTEM MUST BE PROPERLY WINTERIZED PRIOR TO WINTER LAY-UP. SEE SECTION ON WINTERIZING.		



Air Conditioner Sea Strainer



Air Conditioner Seacock (Thru-Hull Valve)

DRAINAGE SYSTEMS

9.1 General

Most water in the cockpit area is drained by gravity to the bilge and where it is pumped overboard by the bilge pump. The rear drain rails for the engine hatch and rear compartments drain by gravity to overboard thru-hull fittings in the hull sides. You should check the drain system frequently to ensure it is free flowing and that the hoses on the thru-hull fittings are secure and not leaking.

9.2 Bilge Drainage

Bilge Pumps

214SS/218SS/234SS/238SS/268SS

The stern bilge pump is activated both manually by a switch in the helm switch panel and automatically by an electronic water level switch built into the pump. The automatic switch remains activated when the battery switch is in the "OFF" position and the batteries are connected. The automatic circuit is protected by a "push to reset" circuit breaker in the battery switch panel and remains activated when the battery switch is in the "OFF" position and the batteries are connected. The manual switch in the helm switch panel is supplied current when the battery switch is activated. It is protected by a breaker in the helm switch breaker panel.

The bilge pump pumps water out of a thru-hull fitting located above the waterline in the starboard rear hull side. See Electrical Systems for additional information on bilge pump operation.

The manual bilge pump switch should be activated briefly each time the boat is used. This will ensure that the pump is operating properly and increase the service life of the pump. The automatic switch should be manually activated periodically by touching and holding the test button on the side of the pump for five seconds to verify operation. This is particularly important before operating the boat offshore.

Bilge Pumps 288SS

There are two bilge pumps, a forward pump in below the cockpit and the aft bilge pump in the engine compartment. The bilge pumps are activated both manually by switches in the helm



Aft Automatic Bilge Pump
214SS/218SS/234SS/238SS/268SS/288SS



288SS Forward Automatic Bilge Pump

station and automatically by an electronic water level switch built into the pump. The automatic switches are connected to the house battery. They are protected by "push to reset" circuit breakers in the battery switch breaker panel and remain activated when the battery switches are in the "OFF" position and the batteries are connected. The manual switches in the helm switch panel are supplied current when the house battery switch is activated. They are protected by fuses in the power management module.

All bilge pumps pump water out of thru-hull fittings located above the waterline in the starboard side of the hull. The aft bilge pump/automatic switch is located in the engine compartment bilge just forward of the engine and the forward pump and automatic switch are located in the cockpit storage compartment bilge.

The manual bilge pump switches should be activated briefly each time the boat is used. This will ensure that the pumps are operating properly and increase the service life of the pumps. The automatic switches should be manually activated periodically by touching and holding the test button on the side of the pump for five seconds to verify operation. This is particularly important before operating the boat offshore.

328SS Bilge Pumps

There are three bilge pumps, one in the forward bilge below the cockpit and the aft bilge pump and an emergency pump in the engine compartment bilge. The bilge pumps are activated both manually by switches in the helm station and automatically by an electronic water level switch built into the pump. The emergency pump is activated automatically by a float switch near the pump. The automatic switches are connected to the house battery. They are protected by "push to reset" circuit breakers in the battery switch breaker panel and remain activated when the battery switches are in the "OFF" position and the batteries are connected. The manual switches in the helm switch panel are supplied current when the house battery switch is activated. They are protected by fuses in the power management module.

All bilge pumps pump water out of thru-hulls located above the waterline in the starboard side of the hull. The aft bilge pump/automatic switch and the emergency pump and automatic switch are located in the engine compartment bilge between the engines. The forward pump/automatic switch are located in the bilge below cockpit.

The manual bilge pump switches should be activated briefly each time the boat is used. This will ensure that the pumps are operating properly and increase the service life of the pumps. The bilge pump automatic switches should be manually activated periodically by touching and holding the test button on the side of the pump for five seconds to verify operation. The emergency pump automatic switch should also be tested. It is manually activated by pushing the test button

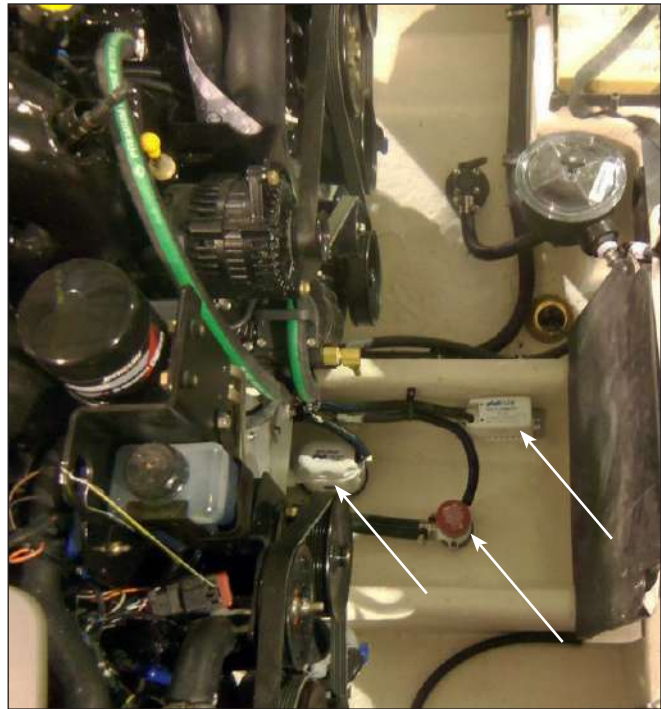

328SS Automatic Aft Automatic Bilge Pump
Emergency Pump & Automatic Switch





Automatic Bilge Pump Test Button
Hold for 5 Seconds or until Pump Activates

on the side of the switch down to verify operation. This is particularly important before operating the boat offshore.



The automatic float switch for emergency bilge pump is mounted above the normal operating range of the aft bilge pump automatic float switch. It activates an alarm if the bilge water level rises above the normal operating range of the bilge pump automatic switches. The alarm switch is connected to the house battery and is protected by the emergency pump "push to reset" breaker located in the engine compartment breaker panel. It remains activated when the battery switches are in the "OFF" position and the batteries are connected.

Bilge Drain Plug Fitting

When the boat is out of the water, the bilge can be drained by a thru-hull drain located in the hull near the transom. The plug should be removed whenever the boat is hauled out of the water and installed just prior to launching. It is important to check the drain plug regularly to make sure it is tight.

	WARNING	
<p>A LOOSE DRAIN PLUG WILL ALLOW SEAWATER TO ENTER THE BILGE AND COULD CAUSE THE BOAT TO SINK. IT IS VERY IMPORTANT TO CHECK THE DRAIN PLUG FREQUENTLY TO ENSURE IT IS PROPERLY TIGHTENED.</p>		

NOTICE:
Any oil spilled in the bilge must be thoroughly removed and properly disposed of before operating the bilge pump. The discharge of oil from the bilge is illegal and subject to a fine.

	CAUTION	
<p>THE FEDERAL WATER POLLUTION CONTROL ACT PROHIBITS THE DISCHARGE OF OIL OR OILY WASTE INTO OR UPON THE NAVIGABLE WATERS OF THE UNITED STATES OR THE WATERS OF THE CONTIGUOUS ZONE IF SUCH DISCHARGE CAUSES A FILM OR SHEEN UPON, OR A DISCOLORATION OF THE SURFACE OF THE WATER, OR CAUSES A SLUDGE OR EMULSION BENEATH THE SURFACE OF THE WATER. VIOLATORS ARE SUBJECT TO A PENALTY OF \$10,000.</p>		



Emergency Pump Automatic Float Switch Test Button
 Push Button Down & Hold Until Pump & Alarm Activate

9.3 Cockpit and Deck Drains Cockpit and Engine Compartment

Water is drained from the cockpit by scupper drains located in the rear of the cockpit. The scuppers drain to thru-hull fittings in the hull sides. A flap built into the thru-hull fitting on side of the hull reduces the surge of sea water through the scupper and into the cockpit.

Water is channeled away from all hatches by a gutter or drain rail system. The water then drains overboard through fittings in the hull sides or to the bilge.

The engine compartment hatch is equipped with a gutter system that drains the water to thru-hull fittings in the hull side or to the swim platform.

Wet Bar Sink Drains 288SS/328SS

The optional wet bar sink and refrigerator are drained by gravity to a thru-hull fitting in the hull side. Storage compartments are drained to the cockpit. The sink and refrigerator drains should be flushed out periodically to keep them clean and free flowing.

Above Deck Cockpit Storage Compartments

The storage boxes, located below the cockpit lounge seat, are drained by gravity to the cockpit deck or to the bilge.

Bow Seat Storage Compartments

The bow seat storage compartments are equipped with drain fittings that drain by gravity to the bilge.

Below Deck Cockpit Storage compartment

The storage compartment below the cockpit drains to the bilge.

Rope Locker Drains

The rope locker drains overboard through a fitting in the starboard hull side. It is important to inspect the drain frequently to remove any accumulated debris.



Typical Rope Locker Drain

9.4 Cabin and Head Compartment Drains (328SS)

The berth compartment drains by gravity to the bilge. The head sink drains by gravity to a thru-hull fitting in the hull side. If the boat is equipped with the optional grey water system, all cabin drains will drain to the grey water sump system. Refer to the Grey Water System in this chapter for additional information for the system.

The shower and optional air conditioner condensation pan are drained by a sump pump system. An automatic float switch in the sump controls the pump. The sump pump is protected by the sump circuit breaker in the battery switch breaker panel. The sump system is activated whenever the HOUSE battery switch is ON to ensure the shower and air conditioner will drain properly whenever they are used. After showering, let the cold water flow for a period of time to flush the drainage system of soap residue.

The sump system is located below the engine compartment. The sump has a removable lid to allow the system to be inspected and serviced. It is essential that the sump system be inspected periodically and any accumulated debris removed. Manually activate the system to verify operation.

9.5 Head Compartment Drains (268SS/288SS)

The head sink drains by gravity to a thru-hull fitting in the hull side. The compartment sole drains to the bilge. If the boat is equipped with the optional grey water system, the sink will drain to the grey water sump system. Refer to the Grey Water System in this chapter for additional information for the system.

9.6 Grey Water System (268SS/288SS/328SS)

If your boat is equipped with this option, all sink drains and the head shower are drained by the sump system which pumps the waste water to the waste/grey water holding tank. The air conditioner condensation pan is connected to a separate sump pump system that pumps the accumulated condensation overboard thru a fitting in the hull side. Both sump systems are controlled by an automatic float switch in the sump and are protected by individual circuit breakers in the battery switch panel. They are activated whenever the house battery switch is on and are located in the engine compartment bilge.

The fluid level in the waste/grey water holding tank is monitored by the "Tank Watch Monitor" in the head compartment. When the holding tank is full, it must be pumped out by an approved waste dumping station.

You should monitor the waste level carefully and not allow the tank to become full. The toilet will not flush when the tank is full and an overfilled holding tank will force waste into the vent filter. This will clog the filter, prevent the sinks from draining and could cause damage to the holding tank. It will also cause unpleasant odors in the cabin.

NOTICE:
The overboard macerator discharge pump option for the waste holding tank is not available with the grey water system.

9.7 Drainage System Maintenance

It is essential that the following items be done periodically to maintain proper drainage of your boat:

- Clean the engine compartment and cockpit deck drain rails with a hose to remove debris that can block water drainage.
- Clean the bilge pump strainers of debris and check the bilge for foreign material that can cause the automatic switches to malfunction.
- Frequently test the automatic bilge pump switches for proper operation. This is accomplished by touching and holding the test button on the side of the pump for five seconds to verify operation. You can also use a garden hose to raise the water level in the bilge until the it is high enough to activate the pump.
- Frequently test the emergency pump automatic float switch. This is accomplished by pushing down on the button on the side of the float switch until the pump is activated. You can also use a garden hose to raise the water level in the bilge until the it is high enough to activate the pump and alarm.
- Flush all gravity drains with fresh water to keep them clean and free flowing.
- Flush the drain in the air conditioning condensation pan with fresh water periodically to remove mold and debris that can accumulate and block drainage to the sump system.
- Clean and inspect the shower and optional air conditioning drain sump system. Remove accumulated debris and flush with fresh water. Frequently test the automatic pump switch for proper operation.
- If your boat is equipped with the optional grey water system, periodically clean and inspect the drain sump system. Remove accumulated debris and flush with fresh water. Frequently test the automatic pump switch for proper operation.



Sump Pump System

NOTICE:
All drains and pumps must be properly winterized before winter lay-up.

NOTICE:
Never use harsh chemical drain cleaners in marine drain systems. Permanent damage to the hoses and fittings may result.

When the boat is out of the water the bilge can be drained by a garboard drain located in the transom near the bottom of the hull. The plug should be removed whenever the boat is hauled out of the water and installed just prior to launching. It is important to check the drain plug regularly to make sure it is tight.

NOTICE:

See Electrical Systems for additional information on bilge pump operation.

NOTICE:

Any oil spilled in the bilge must be thoroughly removed and properly disposed of before operating the bilge pump. The discharge of oil from the bilge is illegal and subject to a fine.



WARNING



A LOOSE DRAIN PLUG WILL ALLOW SEAWATER TO ENTER THE BILGE AND COULD CAUSE THE BOAT TO SINK. IT IS VERY IMPORTANT TO CHECK THE DRAIN PLUG FREQUENTLY TO ENSURE IT IS PROPERLY TIGHTENED.

VENTILATION SYSTEM

10.1 Cabin & Head Compartment Ventilation (268SS/288SS/328SS)

Ventilation to the cabin and/or head compartments is provided by a deck hatch in the 288SS and opening port windows in the 268SS and 328SS.

288SS Head Compartment Hatch

The deck hatch is supported in the open position and secured closed by a cam action latch. To open the hatch, release the latch handle at the bottom and rotate the handle out and up, pushing the hatch open until the latch mechanism cams over and locks in the up position. Close the hatch by pulling the bottom of the latch handle out and down until the hatch closes. Then press the bottom of the handle firmly to lock it in the closed position.

268SS/328SS Port Windows

Opening port windows are located in the cabin and head compartment on the 328SS and the head compartment on the 268SS. Each window opens to provide ventilation into the area and is equipped with a removable screen.

The windows are secured by adjustable cam levers. The cam levers should be adjusted so they are tight enough to seal the windows in the closed position, but not so tight that the window becomes difficult to secure.

Always make sure the windows are closed and secured with the cam levers whenever the boat is underway. Sea spray could enter the cabin through an open window and damage upholstery, woodwork and cabin equipment.



288SS Head Compartment Hatch Closed



288SS Head Compartment Hatch Open



328SS Cabin & Head Compartment Port Windows

Windshield & Cockpit Ventilation

Ventilation to the helm area and cockpit and access to the bow seating area is provided by the opening center windshield panel in 214SS/218SS & 234SS/238SS models and the opening center windshield panel and a walk-through door below the windshield on 268SS/288SS/328SS models.

Windshield Center Panel

The windshield center section is opened by releasing the locks on the inside of the windshield. A magnetic stop on the deck automatically secures the windshield section in the open position. To close the windshield panel, pull on the bottom of the panel until the magnetic latch releases. Then close the panel and secure it with the locks. Make sure the center section is properly secured in the open or closed position before cruising.



CAUTION



USE CAUTION WHEN OPENING CENTER WINDSHIELD PANEL. THE MAGNET THAT HOLDS THE PANEL OPEN IS VERY POWERFUL AND COULD CAUSE INJURY OR DAMAGE TO VESSEL.

TO AVOID INJURY, THE CENTER WINDSHIELD SECTION MUST BE SECURED IN THE OPEN OR CLOSED POSITION WHEN VESSEL IS IN MOTION. MAKE SURE TO USE BOTH LOCKS WHEN SECURING THE WINDSHIELD SECTION IN THE CLOSED POSITION.



288SS Walk-through Door Latched In The Open Position



268SS Walk-through Door Latched In The Closed Position

Bow Walk-through Door 268SS/288SS/328SS

An acrylic door secured with a flush, push to close latch provides the ability to close off the walk-through area below the opening windshield panel when desired. The door is designed to “nest” against the helm storage compartment door on the 268SS and in a recess on the side of the walk-through on the 288SS and 328SS when it is open. The latch secures the door in the open or closed position. To secure the door in either position, push the door until the latch catches. On 268SS models, both doors are opened simultaneously to access the storage compartment when the walk-through door is nested and latched against the storage compartment door.

Always make the walk-through door is securely latched in the open or close position before operating the boat. Periodically clean and lubricate the latches to protect them from corrosion and help keep them operating properly.

10.2 Carbon Monoxide & Proper Ventilation

DANGER

FAILURE TO PROPERLY VENTILATE THE BOAT WHILE THE ENGINES OR GENERATOR ARE RUNNING MAY PERMIT CARBON MONOXIDE TO ACCUMULATE WITHIN THE CABIN AND OPEN AREAS OF YOUR BOAT. CARBON MONOXIDE IS A COLORLESS AND ODORLESS GAS THAT IS LETHAL WHEN INHALED. CARE MUST BE TAKEN TO PROPERLY VENTILATE THE BOAT AND TO AVOID CARBON MONOXIDE FROM ACCUMULATING IN THE BOAT WHENEVER AN ENGINE IS RUNNING.



A by-product of combustion, carbon monoxide (CO) is invisible, tasteless, odorless, and is produced by all engines and gas heating and cooking appliances. The most common sources of CO on boats are gasoline engines, auxiliary generators and propane or butane stoves. These produce large amounts of CO and should never be operated while sleeping. The hazard also may be created by a boat nearby whose exhaust fumes are entering your boat. Boats also have a problem due to the "station wagon effect" where engine exhaust fumes are captured in the vacuum or low pressure area, usually the cockpit, bridge deck and cabin, that can be created by the forward speed of the boat.

Boats underway should close all aft facing hatches and doors. The forward facing deck hatches should be open whenever possible to help pressurize the living spaces of the boat. No sleeping in the cabin should be permitted while underway. Proper ventilation should be maintained on the bridge deck by opening windshield or forward clear connector vents, as far as possible to help pressurize the cockpit area. The canvas drop or aft curtain must be removed and the side curtains should be opened or removed to increase air flow and maintain proper ventilation whenever the engines are running. **Under no circumstances should the engines be operating with side curtains closed and the aft or drop curtain installed.**

Extreme caution must be taken while at anchor or in a slip when an auxiliary power generator is operating. Wind still nights can easily allow exhaust fumes, containing high concentrations of CO, from the generator on your boat or from an adjacent boat's generator to enter the boat. The exhaust fumes may enter your boat through open hatches or windows.

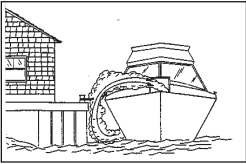
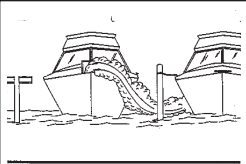
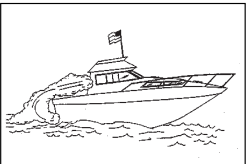
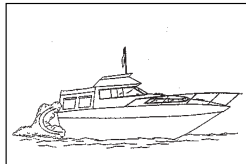
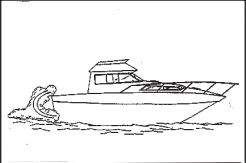

328SS Carbon Monoxide Detector

 <p>Onboard Generator Exhaust - exhaust accumulates because of bulkhead.</p>	 <p>Nearby Generator Exhaust - wind carries exhaust to the other boat</p>
 <p>Back Drafting / Station Wagon Effect - at cruising speed with no forward ventilation</p>	 <p>Back Drafting / Station Wagon Effect - at cruising speed with canvas closed</p>
 <p>Slow Speed or Boat Stopped w/ engines running - CO can accumulate in cabin, cockpit & bridge</p>	 <p>Desired Air Flow Through the Boat</p>

A carbon monoxide detector has been installed in the cabin as standard equipment. While a CO detector enhances your protection from CO poisoning, it does not guarantee it will not occur. Do not use the carbon monoxide detector as a replacement for ordinary precautions or periodic inspections of equipment. Never rely on alarm systems to save your life, common sense is still prudent and necessary. Remember, the operator of the boat carries the ultimate responsibility to make sure the boat is properly ventilated and the passengers are not exposed to dangerous levels of carbon monoxide. You should always be alert to the symptoms and early warning signs of carbon monoxide poisoning. You also should read the "Carbon Monoxide Monitoring System" in the Safety Equipment chapter of this manual, and the owner's manual supplied by the CO detector manufacturer for operation instructions and additional information regarding the hazards and symptoms of carbon monoxide poisoning.



Typical Engine Compartment Vents

! DANGER !

ACTIVATION OF THE CARBON MONOXIDE DETECTOR INDICATES THE PRESENCE OF CARBON MONOXIDE (CO) WHICH CAN BE FATAL. EVACUATE THE CABIN IMMEDIATELY. DO A HEAD COUNT TO CHECK THAT ALL PERSONS ARE ACCOUNTED FOR. DO NOT REENTER THE CABIN UNTIL IT HAS BEEN AIRED OUT AND THE PROBLEM FOUND AND CORRECTED.

! DANGER !

PERIODICALLY TEST THE CARBON MONOXIDE ALARMS PER THE MANUFACTURER'S INSTRUCTIONS. PLEASE REFER TO THE CARBON MONOXIDE ALARM MANUAL OR CONTACT THE MANUFACTURER FOR MORE INFORMATION ON MAINTAINING AND CALIBRATING THE ALARM.

10.3 Engine Compartment Ventilation

All Monterey inboard boats are equipped with an engine compartment ventilation system consisting of intake ducts, exhaust ducts and exhaust blowers. The ventilation system is designed to meet or exceed the requirements of the United States Coast Guard in effect at the time of manufacture and remove fuel vapors and excess heat from the engine room.

Free Air System

A flow of air into the engine compartment is provided by two vents located on either side of the deck. Exhaust ventilation designed into the vents provides a flow of air out of the engine compartment. The exhaust area of the vents have ducts that reach to the lower part of the engine compartment. This provides adequate air movement while operating at or near cruise speeds.

The vents are designed with special baffles that prevent seawater or spray from entering the engine or storage compartments while providing adequate air movement for the engine. On some models, air flows from the deck vent, through the transom storage compartments and then to the engine compartment. Therefore, it is important not to fill these compartments with dunnage to the point the stowed items severely restrict the air flow.

Forced Ventilation

Electric blowers provide ventilation to the engine compartment prior to start up of the main engines or optional generator and while operating below cruise speed or running the generator. The blowers are activated by a switch at the helm or in the generator control panel. The blowers are located in the engine compartment exhaust vent hoses. When activated, the blowers will remove bilge fumes through the exhaust vents. Refer to the Electrical Systems chapter for more information on blower operation.

DANGER

GASOLINE VAPORS CAN EXPLODE. BEFORE STARTING THE ENGINES OR GENERATOR, OPERATE THE ENGINE COMPARTMENT BLOWER FOR FOUR (4) MINUTES, OPEN THE ENGINE ACCESS HATCH, INSPECT THE FUEL SYSTEM AND CHECK THE ENGINE COMPARTMENT FOR THE ODOR OF GASOLINE VAPORS. ALWAYS OPERATE THE BLOWER WHILE THE ENGINES ARE AT IDLE. UNDER NO CIRCUMSTANCES SHOULD THIS PROCEDURE BE OVERLOOKED.

WARNING

ALWAYS RUN THE EXHAUST BLOWER WHEN OPERATING THE BOAT BELOW CRUISE SPEEDS OR WHEN THE OPTIONAL GENERATOR IS OPERATING TO ENSURE ADEQUATE VENTILATION AND COOLING OF THE ENGINE COMPARTMENT.

WARNING

OBSTRUCTING THE VENTILATION SYSTEM WILL RESTRICT AIR IN AND OUT OF THE ENGINE COMPARTMENT. ON SOME MODELS AIR FLOW THROUGH TRANSOM STORAGE COMPARTMENTS IS IMPORTANT FOR PROPER AIR FLOW VOLUME. MAKE SURE AIR FLOW THROUGH THESE COMPARTMENTS IS NEVER RESTRICTED BY OVERLOADING THEM WITH ITEMS THAT WILL BLOCK OR RESTRICT AIR FLOW. DO NOT OBSTRUCT OR MODIFY THE VENTILATION SYSTEM.



288SS Engine Compartment Air Flow Through Storage Compartment

10.4 Maintenance

- Periodically lubricate all hinges and latch assemblies with a light oil.
- Periodically clean and coat gasket materials with silicone to help keep them pliable.
- Opening cabin deck hatches and some cabin doors are made of acrylic plastic glass. Acrylic glass scratches easily. Never use a dry cloth or glass cleaning solutions on acrylic glass. Use a soft cloth and mild soap and water for routine cleaning. Solvents and products containing ammonia can permanently damage acrylic glass. Please refer to the Routine Maintenance chapter for more information on the proper maintenance for acrylic plastic glass.

- Periodic inspection and cleaning of the engine compartment ventilation ducts is necessary to ensure adequate air circulation. A buildup of leaves, twigs, or other debris can severely reduce ventilation. It also is important to be sure that the drains in the vent baffles are open to prevent excessive sea water from accumulating in the vents and overflowing into the engine compartment.
- The bilge blowers are permanently lubricated and require no maintenance. Blower operation can and should be tested by placing a hand over the exhaust vents. Do not rely on the sound of the blowers. A substantial amount of air should be exhausted by the blower. Frequently check the intake vents for obstructions, preferably before each cruise.

NOTICE:
Should blower noise become excessive, the source of the noise should be found and corrected before operating the boat.

THIS PAGE WAS LEFT BLANK
INTENTIONALLY

EXTERIOR EQUIPMENT

11.1 Deck Equipment

Rails and Deck Hardware

The rail system and hardware fittings have been selected and installed to perform specific functions. Hand rails are installed to provide a handhold in certain areas of the boat. You should make sure you keep at least one hand on the handholds as you move about the boat.

Fenders or mooring lines should be secured to the cleats and not to rails or stanchions. The cleats on your boat are retractable and flush with the deck when not in use. To use the cleats, pull up on the center of the cleat until it locks in the mooring position. Be sure a clear lead exists when running dock lines or anchor lines. A line inadvertently run around a stanchion or over the rail could cause damage.

NOTICE:

All fittings must be inspected periodically for loose fit or wear and damage. Any problems should be corrected immediately.



WARNING



MONTEREY BOATS ARE NOT EQUIPPED WITH HARDWARE DESIGNED FOR TOWING PURPOSES. THE MOORING CLEATS ARE NOT TO BE USED FOR TOWING ANOTHER VESSEL OR HAVING THIS BOAT TOWED.



Retractable Cleat Deployed



Retractable Cleat Stowed



Bow Grab/Hand Rails



Anchor/Rope Locker

The anchor locker is in the bow of the boat and accessed through a hatch in the deck. The anchor line is always stored in the rope locker and there is an eye fitting to secure the bitter end of the anchor line. Always make sure the rope locker and deck hatch are closed and properly latched before getting underway.

If the anchor is stored in the anchor locker, it must be properly secured to prevent it from bouncing in the locker and causing damage to the hull or anchor locker. The anchor locker is designed for one fluke style anchor that is properly secured in the cradle. Do not store additional anchors or any heavy object in the anchor locker. Spare anchors and weights for floating markers will bounce and damage the hull or rope locker if they are stored in the anchor/rope locker. Always store and secure additional anchors and weights in a storage compartment in the cockpit, as far aft as possible.



Anchor/Rope Locker & Retractable Bow Boarding Ladder
214SS/218SS & 234SS/238SS

	CAUTION	
<p>A LOOSE ANCHOR IN THE ANCHOR LOCKER WILL BOUNCE AND CAN DAMAGE THE BOAT. THE ANCHOR MUST BE POSITIONED SO IT DOES NOT REST AGAINST THE HULL SIDES AND BE PROPERLY SECURED IN ITS CRADLE AT ALL TIMES WHEN IT IS STORED IN THE ANCHOR LOCKER. DAMAGE RESULTING FROM THE ANCHOR BOUNCING IN THE ANCHOR LOCKER IS NOT COVERED BY THE MONTEREY WARRANTY.</p>		



Bow Ladder Extended
214SS/218SS & 234SS/238SS

A bow ladder rests above the anchor and anchor line when it is in the stored position on some models. To use the anchor, the ladder must be lifted and rotated forward to the deployed position to allow the anchor and anchor line to be removed from the locker. Once the anchor is deployed and the line secure, make sure the ladder is rotated to the stored position, then close the hatch.

Periodically remove the anchor line from the locker, rinse it with fresh water and allow it to dry in the sun. Cleaning the anchor line regularly will reduce odors in the locker and increase the life of the line.

The line should also be inspected for abrasions or signs of deterioration. Replace the line if it shows any sign of damage or deterioration.

Bow Ladder 214SS/218SS/234SS/238SS/268SS/288SS

A telescoping boarding ladder is recessed into the rope locker below the bow hatch. To use the ladder, make sure the engine is off and the boat

is securely moored or anchored with the lines at the bow clear of the hatch and ladder.

Open the anchor/rope locker hatch and rotate the ladder out of the storage recess making sure the bracket rotates with the ladder from inside the rope locker to the deployed position in the bow recesses, extending the ladder forward of the rubrail. Pull to extend the ladder out to the open position. Close and securely latch the anchor locker hatch before using the ladder.

The ladder must be retracted and folded into the rope locker before starting the engine.

Windshield

Your boat is equipped with heavy duty aluminum windshield with tinted glass. The center windshield section opens to provide ventilation and access to the bow seating area.

The section is opened by releasing the locks on the inside of the windshield. A magnetic stop on the deck automatically secures the windshield section in the open position. To close the windshield panel, pull on the bottom of the panel until the magnetic latches releases. Then close the panel and secure it with the locks. Make sure the center section is properly secured in the open or closed position before cruising.



288SS Windshield Center Section Closed

CAUTION

USE CAUTION WHEN OPENING WINDSHIELD WALK-THROUGH SECTION. THIS MAGNET IS VERY POWERFUL AND COULD CAUSE INJURY OR DAMAGE TO VESSEL

TO AVOID INJURY, THE CENTER WINDSHIELD SECTION MUST BE SECURED IN THE OPEN OR CLOSED POSITION WHEN VESSEL IS IN MOTION. MAKE SURE TO USE BOTH LOCKS WHEN SECURING THE WINDSHIELD SECTION IN THE CLOSED POSITION.



288SS Windshield Center Section Open

If the boat is operated in saltwater, the windshield should be washed after each use with soap and water to keep it clean. Saltwater allowed to remain on the windshield frame will eventually begin to attack the aluminum and cause corrosion, usually around fasteners and hardware mounted to the windshield. Snaps or any hardware mounted to the windshield must be properly sealed and isolated with caulk or a Teflon sealer to prevent salty moisture and galvanic corrosion from damaging the frame. Poor maintenance or improperly mounted hardware and snaps can void the warranty on the windshield.

Refer to the Routine Maintenance chapter for more information on the care and maintenance of anodized aluminum.



288SS Windshield Center Section Latches

11.2 Windlass & Bow Roller (268SS/288SS/328SS)

A windlass is optional on the 268SS/288SS and 328SS. The windlass/bow roller installation replaces the bow ladder on 268SS and 288SS models.

The windlass and anchor roller assembly is mounted to the deck in the rope locker below the hatch. The anchor is stored on the roller assembly and is raised and lowered by the windlass. The anchor line is stored in the rope locker and routed out through the windlass to the anchor chain. A chain binder is provided between the windlass and the roller to secure the anchor. Always make sure the anchor is properly secured by the chain binder when it is in the stored position on the roller.

The windless, chain binder, anchor cleat and rope locker is accessed by opening the hatch. The chain binder is designed to connect to a link in the anchor chain when the anchor is hauled in. To release the binder, pull the anchor chain in slightly to relieve the tension on the binder, then release the binder from the chain. To secure the anchor in the up and stored position, raise the anchor until it seats firmly in the roller with the chain snug. Attach the chain binder to a link in the chain. Before getting underway after hauling the anchor, always make sure the binder is properly attached to the anchor chain link and the hatch is closed and latched.

The anchor is lowered by releasing the anchor from the cleat or chain binder near the roller and operating a "DOWN" control at the helm, or the rocker switch at the bow next to the windlass. The windlass control switches are activated and protected by a "push to reset" breaker in the helm switch breaker panel or a fuse in the power management module. The main circuit for the windlass is protected by a heavy duty circuit breaker in the engine compartment or battery switch breaker panel.

After the anchor is set, the windlass must not be left to take the entire force from the anchor line. Boats lying to their anchor in a high swell or heavy weather conditions will snub on the line. This can cause slippage or apply excessive loads to the windlass. The line should be made fast to the anchor line cleat to relieve the load on the windlass.

The anchor is hauled in by releasing the line from the bow cleat and operating the "UP" control at the



288SS Windlass & Roller

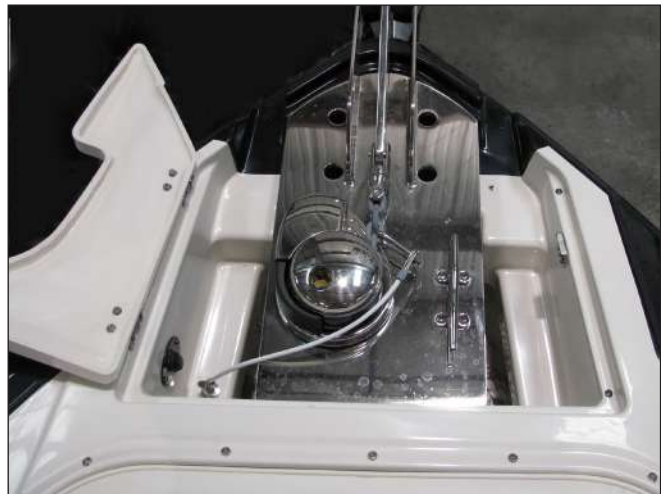

268SS Windlass, Chain Binder & Anchor Line Cleat

helm or the switch on the deck near the windlass. Once the anchor is retrieved, independently secure the anchor to the chain binder to prevent it from being accidentally released. This is especially important while the boat is underway.

A partially lowered and loose anchor can cause considerable damage to the hull. Do not use a windlass as a sole means of securing an anchor in the bow roller. Always secure the anchor line with the chain binder before operating your boat.

The windlass manufacturer provides an owner's manual with its product. It is extremely important that you read the manual and become familiar with the proper care and operation of the windlass.

WARNING

A WINDLASS MUST BE USED WITH CARE. IT IS EXTREMELY IMPORTANT THAT YOU READ THE OWNER'S MANUAL AND BECOME FAMILIAR WITH THE SAFETY INSTRUCTIONS AND PROPER OPERATION OF THE WINDLASS BEFORE USING IT WITH YOUR BOAT. ALWAYS ENSURE THAT LIMBS, FINGERS, HAIR AND CLOTHING ARE KEPT CLEAR OF THE WINDLASS AND ANCHOR LINE DURING OPERATION.

WARNING

DO NOT USE A WINDLASS AS A SOLE MEANS OF SECURING AN ANCHOR IN THE BOW ROLLER. ALWAYS SECURE THE ANCHOR LINE TO A CLEAT OR CHAIN BINDER BEFORE OPERATING YOUR BOAT.



Swim Platform, Storage Compartments & Boarding Ladder
214SS/218SS & 234SS/238SS

Periodically remove the anchor line from the locker, rinse it with fresh water and allow it to dry in the sun. Cleaning the anchor line regularly will reduce odors in the locker and increase the life of the line. The line should also be inspected for abrasions or signs of deterioration. Replace the line if it shows any sign of damage or deterioration. It is important to replace the anchor line with a new line of the type recommended or supplied by the windlass manufacturer.

11.3 Hull Equipment

Swim Platform and Stern Ladder

Your boat is equipped with an integral, fiberglass swim platform located in the stern of the boat. The standard swim platform is equipped with a gelcoat non-skid surface. A synthetic teak (Flexi Teak or SeaDek) inlay is optional. The synthetic teak surface is maintenance free other than routine cleaning.

A telescoping boarding ladder is recessed into a compartment in the swim platform below a special hatch. The compartment is drained overboard to a thru-hull fitting below the platform near the outdrive. To use the ladder, make sure the engine is off and the steering wheel is turned straight ahead or slightly to port to move the props as far away from the ladder location as possible. Open the hatch on the starboard side of the swim platform. Rotate the ladder out of the recess to the down position. Pull to extend the ladder out to the open position. The ladder must be retracted and folded into the recess before starting the engine.



288SS Swim Platform Boarding Ladder Deployed

Swim Platform and Ladder 214SS/218SS/234SS/238SS

The platform on 214SS/218SS and 234SS/238SS models is equipped with an additional wet storage compartment on the platform that drains overboard to a thru-hull fitting in the side of the platform. Only store items that will not be damaged by seawater in this compartment.



WARNING



MOVING PROPELLERS ARE DANGEROUS. THEY CAN CAUSE DEATH, LOSS OF LIMBS, OR OTHER SEVERE INJURY. DO NOT USE THE SWIM PLATFORM OR SWIM LADDER WHILE THE ENGINE IS RUNNING. STOP THE ENGINE IF DIVERS OR SWIMMERS ARE ATTEMPTING TO BOARD. ALWAYS PROPERLY STORE THE LADDER BEFORE STARTING THE ENGINE.

Transom Ski Tow

A stainless steel ski tow fitting is mounted to the center of the swim platform above the outdrive or to the center of the transom just forward of the platform. A removable ski tow pylon that mounts in a flush base in the center of the platform is optional. The pylon can be also be used as a table pedestal for the optional cockpit table.

The tow fitting or pylon are designed for pulling one or two averaged sized skiers or wakeboarders. Always use high quality tow ropes with attachment loops when pulling wakeboarders or skiers. The tow rope should always be attached to the ski tow using the attachment loops and never tied to the ski tow or to any type of metal hook. Tied ski ropes are very difficult to remove and metal hooks will damage the ski tow and the fiberglass around it. Additionally, metal hooks can cause injury to your skiers if the metal hook breaks under the strain of the tow.

When attaching a tow rope using the attachment loops, hold the attachment loop in one hand and pull a length of rope on the handle side of the loop through the loop, creating another 6" loop. Slide the loop just created over the ski tow fitting and pull the handle side of the rope to tighten the loop around the tow fitting. This procedure will attach the rope securely to the ski tow, be easy to remove and will not come off if the skier or wakeboarder falls.

Refer to Water Skiing in the Operation chapter for safety information on operating the boat with a skier.

Stern Storage

214SS/218SS/234SS/238SS/268SS/288SS

There is a large storage compartment located on the port side of the transom below the rear facing bench seat. A 12 volt light activated by the Cockpit Light switch at the helm illuminates the compartment in some models. There are straps that hold ski ropes or mooring lines and the optional cockpit table pedestal is stored in this compartment on some models.



Transom Ski Tow
214SS/218SS & 234SS/238SS



328SS Platform Ski Tow & Ski Pylon



Storage Compartment
214SS/218SS & 234SS/238SS

The compartment drains to the bilge and is equipped with “dry deck” padding to allow for better drainage and air circulation in the compartment. A drain rail around the hatch channels water away from the compartment and overboard through a fitting in the hull side or to the swim platform.

One or two gas springs hold the hatch in the open position and a push to close latch holds it closed. Always make sure the hatch is closed and latched before operating the boat above idle speed.

There is an opening above the starboard side of the compartment on 268SS and 288SS models that provides access to the engine hatch actuator(s) and the emergency quick release pin(s) that allows the engine hatch to be opened manually if the electric hatch actuator should fail.

288SS/328SS Stern Compartments Sunpad Storage Compartment

A large storage compartment is located below the rear of the sunpad. The compartment drains to thru-hull fittings in the hull side and is equipped with “dry deck” padding to allow for better drainage and air circulation in the compartment. A drain rail around the hatch channels water away from the compartment to the swim platform. On 288SS models, the optional cockpit table and pedestal are stored in a special mount in this compartment.

Gas springs help lift the sunpad/hatch and hold it in the open position. A push to close latch secures it closed. Always make sure the sunpad/hatch is closed and latched before operating the boat.

328SS Shore Power Inlet Panel

The shore power inlet panel is located in the compartment on the starboard side of the transom. The compartment drains to the swim platform and a drain rail around the hatch channels water away from the compartment. A gas spring holds the hatch in the open position and a push to close latch holds it closed. Always make sure the shore power cable is removed and properly stored and that the hatch is closed and latched before operating the boat. Refer the Electrical Systems chapter for additional information on the shore power inlet panel.



288SS Port Storage & Sunpad Compartments



328SS Shore Power Inlet Panel

268SS/288SS/328SS Trim Tabs

Trim tabs are standard equipment on the 288SS and 328SS. They are an available option on the 268SS. The trim actuators and planes are mounted to the hull at the transom and controlled by a switch panel at the helm. Refer to the Helm Control Systems chapter for additional information on the trim tabs.

Docking Lights (Optional)

Located at the bow above the bow eye. These lights provide lighting forward of the bow while docking or maneuvering in tight quarters at night. They are activated by the Docking Lights switch in the helm switch panel and should only be used during docking, mooring or anchoring situations. Never use docking lights while cruising. They are not legal for night navigation and may obstruct the visibility of the bow navigation lights to on-coming vessels.

Underwater Lights (Optional)

LED underwater lights are mounted in the transom, below the water line. The lights are activated by the Underwater Lights switch at the helm and should only be used when the boat is in the water with the lights submerged.

Bow Eye and Bow Plate

The bow eye assembly includes a stainless steel bow plate that protects the hull from scuffs and scratches from the trailer bow roller. Whenever possible, the trailer bow roller should be adjusted so that it is positioned on the plate, just below the bow eye.

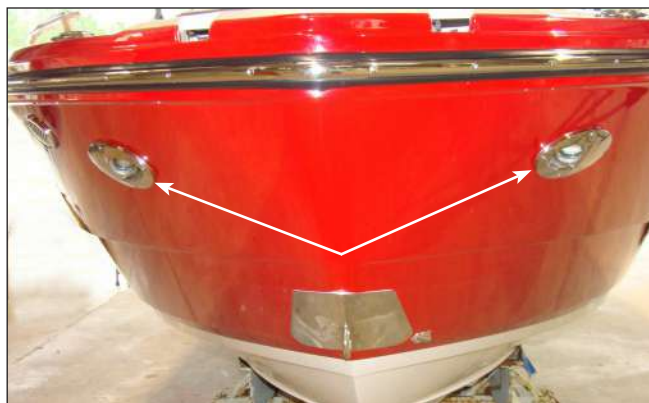

Docking Lights



Typical Bow Eye & Plate

11.4 Cockpit Equipment - All Models Hatch Latches

Some of the hatches and doors in the cockpit are secured with special flush mounted, twist lock latches with handles that store flush in the latch. Others are secured with push to close latches. Gas charged springs are used on some hatches that help raise the hatches and hold them in the open position.

The latch handles on the twist lock latches remain up when the latches are not secured. Always make sure the hatches are closed with the latches in the secured position and the handles folded flush before operating the boat above idle speed.



Typical Twist Lock Latch - Latched With Handle Folded Flush

⚠
WARNING
⚠

IN CERTAIN CONDITIONS, OPEN DOORS AND HATCHES THAT ARE NOT SECURED PROPERLY CAN SLAM CLOSED UNEXPECTEDLY AND CAUSE INJURY TO PASSENGERS OR DAMAGE TO THE BOAT. MOST DOORS AND HATCHES ARE EQUIPPED WITH SPECIAL FASTENERS, HATCH LIFTERS, OR SNAPS AND/OR STRAPS, TO SECURE THEM IN THE OPEN POSITION. ALWAYS MAKE SURE THAT THESE HATCHES AND DOORS ARE PROPERLY SECURED WHENEVER THEY ARE IN THE OPEN POSITION.

Seat Cushion Friction Latches

Some seat cushions and other components are secured with special friction latches. These latches are equipped with a notched male fitting that seats in a rubber female receiver. These latches require a firm upward pull to release and a firm downward push to latch.



Typical Twist Lock Latch - Not Latched With Handle Up

Cockpit Carpet (Optional)

Cockpit carpet is an available option on all models. The carpet is custom made to each model and includes snaps in the carpet and cockpit sole. For the safety of your passengers, always make sure the carpet is secured with the snaps. Carpet that is not secured with the snaps can slide unexpectedly.

Cockpit Table

A removable cockpit table mounts to a bracket on the side of the aft bench seat or on the side of the forward bow seat. A spring loaded pin in the side of each mounting bracket secures the table pedestal in the bracket and prevents it from working loose while the boat is underway.



Typical Cockpit Table & Pedestal

To use the table, remove the table and pedestal from the storage compartments. Pull the safety pin in the side of the mounting bracket and insert the pedestal base firmly in the bracket. Then release the pin and make sure it extends into the pedestal base to secure the pedestal to the base. Install the table on the pedestal. Reverse the process to remove the table.

The table should only be used while at running at slow speeds, at the dock or at anchor. Always remove and properly stow the table and pedestal before cruising or pulling skiers or wakeboarders.



Spring Loaded Pin In Side Mount

Table Storage

214SS/218SS/234SS/238SS

The table is stored in a mounting bracket in the in-floor storage compartment below the cockpit and the pedestal is stored in brackets in the transom storage compartment. Notches in the mounting bracket prevent the table from sliding while the boat is underway.

To prevent damage to the table or storage compartment, make sure it is properly seated in the notches when it is stored in the mounting bracket. Also make sure the pedestal is securely fastened to the brackets in the transom storage compartment.



Table Mounting Location In-Floor Storage Compartment
214SS/218SS & 234SS/238SS

268SS Table Storage

The table and pedestal are stored in special mounting brackets built into the storage compartment just forward of the helm.

To prevent damage to the table or storage compartment, make sure to secure the table with the rotating latch when it is stored in the mounting brackets. Also make sure the pedestal is securely fastened to the brackets next to the table.



268SS Table & Pedestal Storage In Helm Storage Compartment



268SS Table Secured With Rotating Latch

288SS Table Storage

The table and pedestal are stored in special mounting brackets built into the storage compartment below the sunpad.

To prevent damage to the table or storage compartment, make sure the table is fully seated in the mounting brackets before closing the storage compartment hatch. Also make sure the pedestal is securely fastened to the brackets on the bottom of table brackets.



288SS Table Storage In Sunpad Storage Compartment

328SS Table Storage

The table and pedestal are stored in special mounting brackets built into the rear cabin bulkhead just above the berth.

To prevent damage to the table or storage compartment, make sure to secure the table with the latch when it is stored in the mounting brackets. Also make sure the pedestal is securely fastened to the brackets next to the table.



328SS Table Storage Forward of Berth In Cabin

11.5 Cockpit Features (214SS/218SS/234SS/238SS)

Side Storage Compartments

On both sides of the cockpit below the gunnels. Provides storage for lines or small items. There are also drink holders on each side.

Engine Access

The engine hatch is raised manually by releasing the push to close latch at the front of the engine hatch. Two gas springs assist in lifting the hatch and hold it in the open position. There are sunpad and stern bench seat filler cushions on the port side of the engine hatch. Make sure these cushions are removed before raising the hatch.

To raise the hatch, release the latch located in the center of the stern bench seat between the seat and backrest cushions. Then slowly raise the hatch to the full up position. Close the hatch by placing enough down pressure on the hatch to overpower the lifting force of the gas springs. When the hatch is completely closed, press down firmly to latch it in the closed position.



Engine Access
214SS/218SS & 234SS/238SS

Aft Bench Seat

The aft bench seat provides passenger seating in rear of the cockpit. The center backrest cushion raises with engine hatch when it is opened. The starboard backrest and seat cushions can be removed and stored to provide a walkway from the cockpit to the swim platform.

A cooler, the battery switch panel and the fire port are in the compartment below the center seat cushion. The front of the cushion is secured with special friction latches that require a firm upward pull to release and a firm downward push to latch the seat. A removable panel in the cockpit sole below the cooler provides access to the fuel gauge sender and fuel lines on the fuel tank.

The cooler is secured in the compartment by special brackets and a stretch cord on each side. Water from the cooler drains to the compartment floor, then overboard through the cockpit drain system. Always make sure the cooler is properly secured with the stretch straps and that the seat cushion is in place and latched before operating the boat.

Sunpad and Rear Lounge Seat

The sunpad is equipped with a hinged backrest bolster that converts the sunpad to a rear facing lounge seat.

The bolster is raised by lifting the front of the bolster and raising the hinged support until it aligns with the notches in the bolster base. Insert the support into the notches while pushing the bolster forward toward the support until it is fully seated in the bolster base.



Aft Bench Seat
214SS/218SS & 234SS/238SS



Cooler/Battery Switch/Fire Port Compartment
214SS/218SS & 234SS/238SS



Sunpad Backrest Bolster
214SS/218SS & 234SS/238SS



Sunpad Backrest Bolster Support
214SS/218SS & 234SS/238SS

The backrest bolster is lowered by pushing the top of the cushion toward the rear of the boat with one hand while holding the support with the other. When the support is clear of the bolster, fold it against the bottom of the bolster recess and lower the bolster into the recess until it is flush with sunpad.

For the safety of your passengers, always make sure the backrest bolster is folded to the full down position and that no one is on the sunpad whenever the engine is running and/or the boat is underway. Never allow someone to be on the rear facing lounge seat or the sunpad when the engine is running.



Sunpad
214SS/218SS & 234SS/238SS

Helm and Passenger Seats

The helm and passenger pedestal seats are equipped with a flip up bolster to provide more room between the seat and helm or dash area. The bolster converts the seat to a raised seating position and allows the operator and passenger to select the standard seating height or a higher position for better visibility when needed. To convert the seat to the raised cushion position, lift the front of the seat cushion to raise the bolster and push it back above the seat cushion.

The helm and passenger seats are pedestal seats that swivel and adjust fore and aft. There are two levers and a tension knob on the seat base. Lifting the lever located at the port front of the seat base allows the seat to be adjusted fore and aft. Lifting the lever on the starboard side of the seat base releases the pivot lock and allows the helm seat to be swiveled on the pedestal. The helm



Helm & Passenger Seat Base Adjustment Levers



Helm Seat Bolster Up
214SS/218SS & 234SS/238SS



Passenger Seat Bolster Down
214SS/218SS & 234SS/238SS

seat will automatically lock when it is swiveled back to the operating position. The friction knob adjusts the tension of seat base on the pedestal. It should be adjusted to allow the seat to be swiveled when the swivel lock is released and tight enough to eliminate play between the seat base and the pedestal. The friction knob also can be tightened to secure the seats in position and prevent them from swiveling if desired.

FWD/Aft Facing Lounge Seat (Optional)

The seat replaces the port pedestal seat and connects to the aft bench seat. It is equipped with storage below the seat cushion and an adjustable backrest cushion.

The backrest has two positions. In the aft position, it is a back rest cushion for the forward facing passenger seat. In the forward position, it makes a rear facing lounge seat that connects to the port side of the aft bench seat. The backrest is moved by lifting the center of the back rest and moving it toward the desired position. When the backrest reaches the desired position it will drop slightly and lock. Make sure the backrest is locked in the aft or forward position before operating the boat.

Helm

The steering, engine control, engine instruments and switches for exterior equipment and navigation lights are located on the helm station. The helm station is designed to provide good visibility and a functional control station.

The steering wheel is located on the rear of the helm console. The engine shift and throttle control is on the side of the cockpit, next to the helm. The helm switch panels are just forward of the steering wheel and the engine ignition switch is located on the helm below the steering wheel. The circuit breakers for helm activated accessories are located in a panel below the steering wheel and switch panels.

In-Floor Storage Compartment

There is a large storage compartment located below the cockpit floor between the helm and passenger seats. The compartment drains to the bilge and is equipped with "dry deck" padding to allow for better drainage and air circulation in the compartment. A drain rail around the hatch channels water away from the compartment to the bilge. The battery(s), stern nav/anchor light and the optional table are among the equipment mounted or stowed in this compartment.



Lounge Seat Backrest - Forward Facing Seat Position
214SS/218SS & 234SS/238SS



Lounge Seat Backrest - Aft Facing Seat Position
214SS/218SS & 234SS/238SS



Helm
214SS/218SS & 234SS/238SS

A gas spring holds the hatch in the open position and a flush twist latch holds it closed. The handle on the twist lock latch remains up when the latch is not secured. Always make sure the hatch is closed with the latch in the secured position and the handle folded flush before operating the boat above idle speed.

A mounting bracket for stowing the optional cockpit table is located at the front of the compartment just forward of the gas springs. Brackets on the starboard side secure the stern anchor/nav light when it is not being used. When stowing the table, always make sure it is properly seated in the bracket notches.

Notice:

If your boat is equipped with an optional arch, the nav/anchor light will be mounted to the arch and there will be no stern nav/anchor light storage in the in-floor compartment.

Bow Seats and Storage Compartments

The bow area is equipped with seats, a grab rail and built in drink holders that drain to the bilge. The anchor locker and retractable forward boarding ladder are located just forward of the front of the bow seating area. There are storage compartments below each seat cushion and two large storage compartments behind the port and starboard rear backrest cushions. All storage compartments drain to the bilge.

The side seat cushions are secured with special friction latches that require a firm upward pull to release and a firm downward push to latch the seat. Always make sure the seats are installed and latched before operating the boat.

The area is illuminated by LED lights recessed into the seat bases. The lights are activated by the Cockpit Lights switch in the helm switch panel.

The optional cockpit table pedestal mounts to a bracket on the rear side of the forward seat base. Refer to the cockpit table section in this chapter for instructions on installing the table.

The bow seat area is accessed by releasing the two latches on the center windshield panel and opening it. A magnetic stop on the deck automatically secures the windshield section in the open position. Use caution when opening the windshield walk-through. The magnet is very powerful and could cause injury or damage to the



In-Floor Storage Compartment
214SS/218SS & 234SS/238SS



In-Floor Storage Compartment Battery Mounting Location
214SS/218SS & 234SS/238SS





Bow Seating Area
214SS/218SS & 234SS/238SS

deck or windshield if the window is allowed to slam against the stop. To close the windshield panel, pull on the bottom of the panel until the magnetic stop releases. Then close the panel and secure it with the locks. Make sure the center section is properly secured in the open or closed position before cruising. Refer to the Windshield section in this chapter and the Ventilation chapter for more information on the windshield.

Always make sure the center windshield panel is secured in the open or closed position and that passengers in the bow seating area are properly seated before operating the boat above idle speed. The passengers also should not be restricting the forward visibility of the operator.



Storage Compartments Below Bow Seats
214SS/218SS & 234SS/238SS

	WARNING	
<p>PASSENGERS RIDING BOW SEATING AREA WHILE CRUISING COULD RESTRICT THE OPERATOR'S VISIBILITY. THIS IS A FREQUENT CAUSE OF ACCIDENTS. POSITION PASSENGERS SO THEY DON'T BLOCK THE OPERATOR'S VISIBILITY OR MOVE THEM TO SEATS IN THE MAIN COCKPIT WHILE THE BOAT IS CRUISING.</p>		

11.6 Cockpit Equipment (268SS/288SS) Transom/Battery Switch Panel Door

The door that encloses the battery switch panel can also be used as a transom door. The door is secured automatically in either position by a magnetic latch system. It functions as a transom door when it is latched open across the walkway from the cockpit to the swim platform. The door encloses the battery switch panel when it is latched closed to the panel.



288SS Transom/Battery Switch Panel Door
Door Enclosing Battery Switch Panel

To use the door to close off the walkway to the platform, swing the door open until it latches in the transom door position. Swing the door until it latches in the battery switch panel recess to open the walkway and enclose the battery switch panel.

The walkway to the swim platform should be open only when the boat is not in motion. It is important that the door be latched in either the transom door position or in the battery switch panel recess. Never leave the transom door unsecured.

NOTICE:
Periodically inspect the transom door fittings for wear, damage, or loose fit. Any problems should be inspected and corrected immediately.



288SS Transom/Battery Switch Panel Door
Door In Transom Door Position Closing Off
Swim Platform Walkway

WARNING

OPERATING THE BOAT UNDER POWER WITH THE TRANSOM DOOR OPEN MAY ALLOW PERSONS TO FALL OVERBOARD AND INTO BOAT PROPELLERS OR TO BE LOST IN OPEN WATER. ALWAYS CHECK TO MAKE SURE THE TRANSOM DOOR IS PROPERLY CLOSED AND SECURED BEFORE STARTING THE ENGINE AND NEVER OPERATE THE BOAT UNDER POWER WITH THE TRANSOM DOOR OPEN.

Cockpit Storage Compartments

A Compartment for the stereo, battery switch panel and storage for small items is located in starboard side of the cockpit, just forward of the swim platform walkway.

Additional compartments are located next to the helm and on the port side of the cockpit.

Engine Access

The engine hatch is raised by one electric actuator on the 288SS and two actuators on the 268SS that are activated by the Engine Hatch switch in the helm switch panel. The actuators raise the hatch and support it in the open position.

The filler cushion on the aft L-lounge seat must be removed and the transom/battery switch panel door must be secured against the battery switch panel before opening the engine hatch.

An emergency jumper battery connection system is an available option for your boat. If the boat batteries are dead, the engine hatch can be raised by using a jumper battery connected to the emergency jumper terminals in the battery switch panel using a jumper harness. To raise the hatch using a jumper battery, remove the plastic caps on the emergency jumper terminals and connect the red clamps on the harness to the positive terminal on the jumper battery and red emergency terminal. Then connect the black clamps to the negative battery terminal first and then to the black emergency terminal. Once the jumper battery is connected, use the Engine Hatch switch in the helm switch panel to raise the engine hatch.

If the electric actuator system fails and your boat is not equipped with jumper battery connections, the hatch can be raised manually by disengaging the actuator(s) from the engine hatch. To lift the hatch manually, open the stern storage compartment on the port side of the engine hatch. Then reach over the storage compartment bulkhead and remove the quick release pin in the hinge fitting at the top of the actuator(s).



288SS Engine Hatch



268SS Engine Hatch

Once the pin or pins are removed, the engine hatch can be lifted to the open position. The engine hatch is heavy and requires two people to lift it. Additionally you should be prepared to support the hatch in the open position with 2 x 4's of the proper length. The supports must be installed so that they can't slip and allow the engine hatch to fall. Repair the engine hatch actuator and properly attach it to the boat and engine hatch before performing any other service to components in the engine compartment.

WARNING

THE ENGINE HATCH IS HEAVY AND CAN DAMAGE THE BOAT OR CAUSE SEVERE INJURY TO PEOPLE WORKING IN THE ENGINE COMPARTMENT IF IT FALLS. ALWAYS HAVE A PERSON MONITOR THE TEMPORARY ENGINE HATCH SUPPORT TO MAKE SURE IT CANNOT SLIP WHILE THE ENGINE HATCH ACTUATOR IS BEING REPAIRED. NEVER ENTER THE ENGINE COMPARTMENT WHILE IT IS SUPPORTED BY THE TEMPORARY SUPPORT WITHOUT SOMEONE HOLDING THE SUPPORT TO ENSURE IT CAN'T SLIP AND ALLOW THE HATCH TO FALL.



268SS Aft Bench/L-Lounge Seat



288SS Aft Bench/L-Lounge Seat

Aft Bench/L-Lounge Seat

The aft bench/L-lounge seat provides passenger seating in rear of the cockpit. The aft bench seat is built into the engine hatch and raises with the hatch when it opens. The starboard rear backrest cushion folds down to extend the sunpad. Refer to the sunpad in this section for instructions to fold the backrest.

On 288SS models, the starboard aft bench seat backrest cushion raises with the engine hatch. The seat bases and port backrest cushion are fixed and do not raise with engine compartment hatch. The batteries are located in the compartment below the removable port side bench seat cushion.

A filler cushion on the port side of the lounge seat connects the aft bench seat to the aft facing lounge seat to convert the seats to an L-lounge. The filler cushion must be removed before raising the engine hatch.

Sunpad and Rear Facing Lounge Seat

The sunpad is equipped with a hinged backrest bolster that converts the sunpad to a rear facing lounge seat.

The bolster is raised by lifting the front of the bolster and raising the hinged support until it aligns with the notches in the bolster base. Insert the support into the notches while pushing the bolster forward toward the support until it is fully seated in the bolster base.



288SS Batteries In Aft Bench Seat Compartment



288SS Sunpad

The backrest bolster is lowered by pushing the top of the cushion toward the rear of the boat with one hand while holding the support with the other. When the support is clear of the bolster, fold it against the bottom of the bolster recess and lower the bolster into the recess until it is flush with sunpad.

The aft bench seat backrest folds down to extend the sunpad. To fold the backrest, pull the spring loaded pin on the backrest hinge until the backrest releases. Fold the backrest down until it is flush with the sunpad and the pin locks in the down position. Reverse the process to raise the backrest to the sitting position.

For the safety of your passengers, always make sure the backrest bolster is folded to the full down position and that no one is on the sunpad whenever the engine is running and/or the boat is underway. Never allow someone to be on the rear facing lounge seat or the sunpad when the engine is running.

288SS Sunpad Storage Compartment

There is a compartment just forward of the swim platform, below the sunpad. The compartment provides storage for the shore cords, water hose, and fenders.

The hatch is equipped with special mounting brackets for the cockpit table and pedestal. It is drained by gravity to the engine hatch drain system.

Gas charged springs on the storage compartment hatch help lift the hatch and support it when it is in the open position. A lift to release latch secures the hatch when it is closed and a LED light comes on when it is open.



288SS Sunpad With Backrest Bolster Raised



Sunpad with Aft Bench Backrest Folded to Extend Sunpad

	WARNING	
DO NOT STORE FUEL OR FLAMMABLE LIQUIDS IN THE TRANSOM STORAGE COMPARTMENT. VENTILATION WAS NOT PROVIDED FOR EXPLOSIVE VAPORS.		

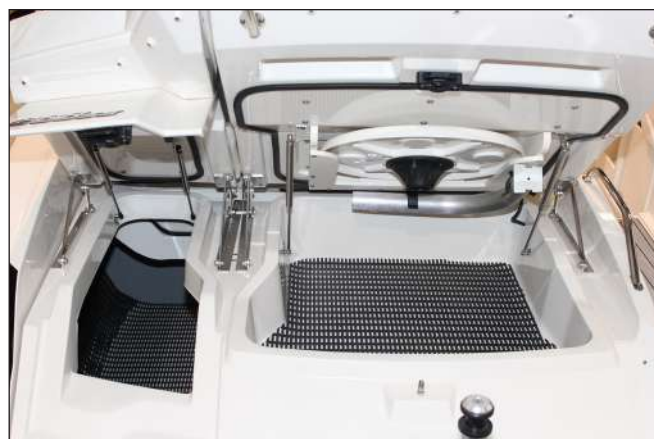

Sunpad Storage Compartment



268SS Pedestal Seat



288SS Helm Seat With Bolster Down

268SS Helm and Passenger Seats

The helm and passenger pedestal seats are equipped with a flip up bolster to provide more room between the seat and the helm or dash area. The bolster converts the seat to a raised seating position and allows the operator and passenger to select the standard seating height or a higher position for better visibility when needed. To convert the seat to the raised cushion position, lift the front of the seat cushion to raise the bolster and push it back above the seat cushion.

The helm and passenger seats are pedestal seats that swivel and adjust fore and aft. There are two levers and a tension knob on the seat base. Lifting the lever located at the port front of the seat base allows the seat to be adjusted fore and aft. Lifting the lever on the starboard side of the seat base releases the pivot lock and allows the helm seat to be swiveled on the pedestal. The helm seat will automatically lock when it is swiveled back to the operating position. The friction knob adjusts the tension of seat base on the pedestal. It should be adjusted to allow the seat to be swiveled when the swivel lock is released and tight enough to eliminate play between the seat base and the pedestal. The friction knob also can be tightened to secure the seats in position and prevent them from swiveling if desired.

288SS Helm Seat

The helm seat is equipped with a flip up bolster to provide more room between the seat and the helm. The bolster converts the seat to a leaning post style seat with a backrest and allows the operator to sit or stand at the helm. To convert the seat to a leaning post, lift the front of the seat cushion to raise the bolster and push it back above the seat cushion.



288SS Helm Seat With Bolster Up

The seat is mounted on a slide track that allows the seat to move fore and aft. Pull the lever located at the port front side of the seat base to release the slide track and adjust the seat to the desired position. Release the lever to lock the seat in position.

Two arm rests on each seat provide a more comfortable driving position and swing up into the backrest cushion to make it easier to enter and exit the helm area.

288SS FWD/Aft Facing Lounge Seat

The port side lounge seat is equipped storage below the removable seat cushion and an adjustable backrest cushion. The front of the removable cushion is secured with special friction latches that require a firm upward pull to release and a firm downward push to latch the seat.

The backrest has two positions. In the aft position, it is a back rest cushion for the forward facing passenger seat. In the forward position, it makes a rear facing lounge seat.

The backrest is moved by lifting the center of the back rest and moving it toward the desired position. When the backrest reaches the desired position it will drop slightly and lock. Make sure the backrest is locked in the aft or forward position before operating the boat.

The forward part of the seat is equipped with a flip up bolster to provide more room between the seat and the dash area. The bolster converts the seat to a raised seating position and allows the operator and passenger to select the standard seating height or a higher position for better visibility when needed. To convert the seat to the raised cushion position, lift the front of the seat cushion to raise the bolster and push it back above the seat cushion.

268SS Aft Facing Seats

Port and starboard aft facing jump seats are standard on the 268SS. A removable cooler is located in the compartment below each seat cushion. The front of the cushion is secured with special friction latches that require a firm upward pull to release and a firm downward push to latch the seat.

The coolers are secured in the compartments by special mounting brackets and a stretch cord on each side. Water from the cooler drains to the compartment floor, then overboard through the cockpit drain system. Always make sure the cooler is properly secured with the stretch cords and the seat cushion is in place and secure before operating the boat.



288SS Fwd/Aft Facing Lounge Seat
Forward Facing Position With Bolster Up



288SS Fwd/Aft Facing Lounge Seat
Forward Facing Position With Bolster Down



268SS Starboard Aft Facing Seats



288SS Fwd/Aft Facing Lounge Seat
Aft Facing Lounge Position

268SS Refrigerator

A 12 volt DC cockpit refrigerator is an available option on the 268SS. The refrigerator door has a special latch to secure the door while under way. Make sure the door is properly secured whenever the boat is moving.

Care should be exercised while operating the refrigerator on 12-volt power without the engine running. It draws a substantial amount of current and can severely drain the house battery through extended use.

Refer to the refrigerator owner's manual for additional operating and maintenance instructions.



268SS Aft Facing Seat Cooler

288SS Aft Facing Seat

The starboard aft facing seat is located aft of the helm seat. A storage compartment is located in the seat base below the removable seat cushion. The front of the cushion is secured with special friction latches that require a firm upward pull to release and a firm downward push to latch the seat.

There is a padded armrest with a cup holder and storage compartment that drain to the cockpit on the forward side of seat. A slide out trash receptacle is located in the compartment below the armrest. It is mounted on a slide track with a door face that is secured with a push to close latch. Pull the latch handle to release the latch and slide the receptacle out. To close, push door face and slide the receptacle in until the latch catches. Periodically clean and lubricate the latch to protect it from corrosion and help keep it operating properly.



288SS Aft Facing Seat & Trash Receptacle

Helm

The steering, engine control, engine instruments and switches for exterior equipment and navigation lights are located on the helm station. The helm station is designed to provide good visibility, room for electronics and a functional control station.

The steering wheel is located on the rear of the helm console. The engine shift and throttle control is on the side of the cockpit, next to the helm. The helm switch panels are on each side of the steering wheel and the engine ignition switch is located on the helm below the steering wheel. The circuit breakers or fuses for the helm activated accessories are located in a panel in the storage locker, forward of the helm. Molded-in electronics storage is located in the center of the helm, forward of the steering wheel.



288SS Helm

An optional GPS/chart plotter/depth sounder may be installed in the helm and an electronic depth sounder with a shallow water alarm is standard. Electronic navigational equipment manufacturers provide detailed instruction manuals with their products. You should read them carefully and review the operation of the electronics with your dealer at the time of delivery.

The back of the helm station is accessed through removable panels in the large storage compartment just forward of the helm. The panels provide access to service the helm equipment, accessory switch panels and other components installed in the helm. The circuit breakers or fuses that protect the circuits activated by the helm switches and the electronics are located in a panel on the rear of the storage compartment.

268SS Helm Storage Compartment

There are two matched acrylic doors secured with flush, push to close latches that provide access to the large storage compartment forward of the helm. The outside door is used to close off the walk-through area below the opening windshield panel when desired and is designed to "nest" to the storage compartment door when it is open. To secure the door in either position, push the door until the latch catches. Both doors open simultaneously to access the storage compartment when the walk-through door is nested to the storage compartment door. Periodically clean and lubricate the latches to protect them from corrosion and help keep them operating properly.

A 12 volt light activated by a switch on the light fixture illuminates the compartment. The compart-



268SS Helm



268SS Helm Storage Compartment & Walk-through Door



268SS Walk-through Close Off Door



268SS Helm Storage Compartment
Showing Optional Table & Bow Filler Cushion Storage

ment is equipped with special mounting brackets for the cockpit table and bow filler cushions. It is also where the amplifier for the stereo option is mounted.

The door could be damaged or hurt a passenger by the motion of the boat if it is allowed to swing free. Always make sure the door is latched in the open or closed position in rough water or when the boat is underway.

288SS Helm Storage Compartment and Walk-through Close Off Door Storage Compartment Door

A large acrylic door with a push to close latch provides access to the storage compartment forward of the helm. A 12 volt light activated by a switch on the light fixture illuminates the compartment.



288SS Helm Storage Compartment

The compartment is equipped with special mounting brackets for the bow filler cushions. It is also where the amplifier for the stereo option is mounted.

Walk-through Door

Another acrylic door on the opposite side of the walk-through from the helm storage compartment is used to close off the walk-through area below the opening windshield panel when desired. It is designed to "nest" into a recess on the port side of the walk-through when it is open. To secure the door in either position, push the door until the latch catches.



288SS Walk-through Close Off Door Open

The doors could be damaged or hurt a passenger by the motion of the boat if they are allowed to swing free. Always make sure the storage compartment door is latched in the closed position and that the walk-through door is latched in either the open or closed position in rough water or when the boat is underway.

Periodically clean and lubricate the latches to protect them from corrosion and help keep them operating properly.

In-Floor Storage Compartment

There is a large storage compartment located below the cockpit floor between the helm and passenger seats. The compartment drains to the bilge and is equipped with "dry deck" padding to allow for better drainage and air circulation in the compartment. A drain rail around the hatch channels water away from the compartment to the bilge.



288SS Walk-through Close Off Door Closed

A gas spring holds the hatch in the open position and a flush twist latch holds it closed. The handle on the twist lock latch remains up when the latch is not secured. Always make sure the hatch is closed with the latch in the secured position and the handle folded flush before operating the boat above idle speed.

Models with the optional grey water system could be equipped with a sump pump that is located below an access hatch in the floor of this compartment. Refer to the Drainage Systems chapter for information on the grey water system.

Head Compartment Door

A large head compartment is located forward of the passenger seat. A molded fiberglass door secured with a lockable push to close latch provides access to the compartment. A grab rail on the door provides a hand hold for passengers and a lockable compartment provides storage for small items.

The door could be damaged or hurt a passenger by the motion of the boat if it is allowed to swing free. It should be in the closed position and latched when not being used, particularly in rough water and whenever the boat is underway. When closing the door, make sure you push the door against the door jam with enough pressure to allow the latch to secure the door. Periodically clean and lubricate the latch to protect it from corrosion and help keep it operating properly.



The head compartment is designed to accommodate a portable marine toilet or an optional porcelain marine toilet with a holding tank. Refer to the Interior Equipment chapter for additional information on head compartment equipment and operation.



288SS In-Floor Storage Compartment



288SS Head Compartment Door

	CAUTION	
<p>NEVER LEAVE THE HEAD DOOR UNLATCHED. THE HEAD DOOR IS HEAVY AND SWINGS EASILY. IF THE DOOR IS LEFT UNLATCHED, IT COULD SWING UNEXPECTEDLY AS THE BOAT ROCKS, DAMAGING THE DOOR OR CAUSING AN INJURY TO A PASSENGER. TO AVOID INJURY TO PASSENGERS OR DAMAGE TO THE BOAT, ALWAYS CLOSE AND SECURE COMPARTMENT DOOR WHENEVER THE HEAD COMPARTMENT IS NOT BEING USED, THE BOAT IS IN MOTION OR IN ROUGH WATER CONDITIONS.</p>		



288SS Head Compartment Door Latch

Bow Seats and Storage Compartments

The bow area is equipped with seats, a grab rail and built in drink holders that drain to the bilge.

The anchor locker and retractable forward boarding ladder are located just forward of the bow seating area. The area is illuminated by LED lights recessed into the seat bases. The lights are activated by the Cockpit Lights switch in the helm switch panel.

The optional cockpit table pedestal mounts to a bracket on the rear side of the forward seat base. Refer to the cockpit table section in this chapter for instructions on installing the table.

268SS Seating

The bow area is equipped with seats, a grab rail and built in drink holders that drain to the bilge. The anchor locker and retractable forward boarding ladder are located just forward of the front of the bow seating area. There are storage compartments below each seat cushion that drain to the bilge.

The side seat cushions are secured with special friction latches that require a firm upward pull to release and a firm downward push to latch the seat. Always make sure the seats are installed and latched before operating the boat.

Bow filler cushions are an available option. The removable filler cushions convert the seating area to a sunpad. The removable filler cushions are stored in special brackets in the helm storage compartment when not being used. The seat cushions rest on molded fiberglass supports on each side of the bow seating area

288SS Seating

The 288SS bow seat area is equipped with a molded in, rear facing bench seat with storage below the seat cushion. There are also forward facing seats on each side with folding armrests forward of the windshield. Removable filler cushions that convert the seating area to forward or aft facing lounge seats are an available option. The removable filler cushions are stored in special brackets in the helm storage compartment when not being used. The seat cushions rest on molded fiberglass supports at the front of the forward facing seats and rear edge of the bench seat.

Bow Seating Area Access

The bow seat area is accessed by releasing the two latches on the center windshield panel and opening it. A magnetic stop on the deck automatically secures the windshield section in the open position. Use caution when opening the windshield walk-through. The magnet is very powerful and could cause injury or damage to the deck or windshield if the window is allowed to slam against the stop.



268SS Bow Seats



268SS Bow Seating Area - No Filler Cushions

To close the windshield panel, pull on the bottom of the panel until the magnetic stop releases. Then close the panel and secure it with the locks. Make sure the center section is properly secured in the open or closed position before cruising. Refer to the Windshield section of this chapter and the Ventilation chapter for more information on the windshield.

Always make sure the center windshield panel is secured in the open or closed position and that passengers in the bow seating area are properly seated before operating the boat above idle speed.

The passengers also should not be restricting the forward visibility of the operator.

WARNING

PASSENGERS RIDING BOW SEATING AREA WHILE CRUISING COULD RESTRICT THE OPERATOR'S VISIBILITY. THIS IS A FREQUENT CAUSE OF ACCIDENTS. POSITION PASSENGERS SO THEY DON'T BLOCK THE OPERATOR'S VISIBILITY OR MOVE THEM TO SEATS IN THE MAIN COCKPIT WHILE THE BOAT IS CRUISING.

Portable Propane Grill - 268SS/288SS

A portable propane gas grill is an available option on 268SS and 288SS models. Propane fuel for the grill is usually provided by 1 lb disposable propane fuel canisters. The fuel canisters are sold separately and were not included with the grill.

Portable gas grills can be a fire hazard if not used properly and are not intended for use in the cockpit. The grill should only be used on the special grill pedestal mounted on the swim platform or onshore in an open, uncovered area. When using the grill on the swim platform, make sure the "S" shaped pedestal is rotated such that the grill is over the water so grease drippings fall to the water and not onto the swim platform.

Always make sure the grill is allowed to cool and that the propane fuel canister is removed and capped before storing the grill and fuel canister onboard the boat. Propane fuel is very flammable and must be used and stored properly. Refer to the grill manufacturer's operating manual for additional safety and operating instructions before using the propane grill.

WARNING

PROPANE GAS IS EXTREMELY FLAMMABLE AND CAN CAUSE A FIRE OR AN EXPLOSION THAT WILL RESULT IN SEVERE INJURY OR DEATH IF IT IS NOT STORED AND USED PROPERLY. REMEMBER THAT PROPANE VAPOR IS HEAVIER THAN AIR AND CAN SETTLE AND ACCUMULATE IN UNVENTILATED COMPARTMENTS OR IN THE BILGE.

PROPANE FUEL CANISTERS MUST BE DISCONNECTED FROM THE GRILL AND PROPERLY STORED IN A COCKPIT STORAGE COMPARTMENT THAT IS ABOVE THE COCKPIT SOLE. THE COMPARTMENT MUST BE DRY WITH NO ELECTRICAL COMPONENTS OR SWITCHES ON OR IN THE COMPARTMENT THAT COULD CAUSE A SPARK. NEVER STORE PROPANE FUEL CANISTERS IN THE CABIN, HEAD COMPARTMENT, ENGINE COMPARTMENT, BILGE OR A COMPARTMENT BELOW THE COCKPIT SOLE.



288SS Bow Seating Area



288SS Bow Seating Area - Filler Cushions Installed



288SS Bow Seating Area - No Filler Cushions



Aft Bench Seat/L-Lounge, Cockpit Storage & Transom Door

11.7 Cockpit Features (328SS)

Transom Door

A transom door is incorporated into the port rear of the cockpit. The door is secured automatically in the open or closed position by a magnetic latch system. The door is flush with the cockpit side when it is open.

The walkway to the swim platform should be open only when the boat is not in motion. It is important that the door be latched in either the closed or open position. Never leave the transom door unsecured.

NOTICE:

Periodically inspect the transom door fittings for wear, damage, or loose fit. Any problems should be inspected and corrected immediately.



WARNING



OPERATING THE BOAT UNDER POWER WITH THE TRANSDOR DOOR OPEN MAY ALLOW PERSONS TO FALL OVERBOARD AND INTO BOAT PROPELLERS OR TO BE LOST IN OPEN WATER. ALWAYS CHECK TO MAKE SURE THE TRANSDOR DOOR IS PROPERLY CLOSED AND SECURED BEFORE STARTING THE ENGINE AND NEVER OPERATE THE BOAT UNDER POWER WITH THE TRANSDOR DOOR OPEN.

Cockpit Storage Compartments

A compartment for the battery switch panel is located on the port side of the cockpit, just forward of the swim platform walkway. The cockpit shower and shore water connection are in another compartment just aft of the transom door.

Additional compartments with cup holders are located next to the helm and on each side of the cockpit.

Engine Access

The engine hatch is raised by an electric actuator that is activated by the Engine Hatch switch in the helm switch panel. The actuator raises the hatch and supports it in the open position.

An emergency jumper battery connection system is an available option for your boat. If the boat batteries are dead, the engine hatch can be raised by using a jumper battery connected to the emergency jumper terminals in the battery switch panel using a jumper harness. To raise the hatch using a jumper battery, remove the plastic caps on the emergency jumper terminals and connect the red clamps on the harness to the positive terminal on the jumper battery and red emergency terminal. Then connect the black clamps to the negative battery terminal first and then to the black emergency terminal. Once the jumper battery is connected, use the Engine



Sunpad With Aft Seat Backrest Up - Extending Sunpad

Hatch switch in the helm switch panel to raise the engine hatch.

Aft Bench/L-Lounge Seat

The aft bench/L-lounge seat provides passenger seating in rear of the cockpit. The bench seat backrest is built into the engine hatch and raises with the hatch when it opens. An actuator controlled by a switch in the battery switch panel raises the bench seat backrest to extend the sunpad. Refer to the sunpad in this section for information on the sunpad.

A filler cushion on the starboard side of the lounge seat connects the aft bench seat to the aft facing seat to convert the seats to an L-lounge. The filler cushion should be properly stored in the cabin compartment whenever it is removed.

Sunpad and Rear Facing Lounge Seat

The sunpad is equipped with a hinged backrest bolster that converts the sunpad to a rear facing lounge seat.

The bolster is raised by lifting the front of the bolster and raising the hinged support until it aligns with the notches in the bolster base. Insert the support into the notches while pushing the bolster forward toward the support until it is fully seated in the bolster base.



Sunpad With Rear Facing Backrest Bolster Up



Sunpad & Aft Bench Seat

The backrest bolster is lowered by pushing the top of the cushion toward the rear of the boat with one hand while holding the support with the other. When the support is clear of the bolster, fold it against the bottom of the bolster recess and lower the bolster into the recess until it is flush with sunpad.

The aft bench seat backrest raises to extend the sunpad. The backrest is raised by an electric actuator controlled by a the Aft Seat rocker switch in the battery switch panel. To raise the backrest, press the top of the switch until the backrest is in the desired position. To lower the backrest, press the bottom of the switch until the actuator stops in the full down position.

For the safety of your passengers, always make sure the backrest bolster is folded to the full down position and that no one is on the sunpad whenever the engines are running and/or the boat is underway. Never allow someone to be on the rear facing lounge seat or sunpad when the engines are running.

Sunpad/Transom Compartments

There is a storage compartment just forward of the swim platform, below the rear of the sunpad. Another compartment on the starboard side of the transom provides protection for the shore connections for the 120 volt AC system, TV and telephone. A molded recess in the compartment allows the hatch to be closed with the shore cords attached to the utilities at the dock. The hatch is supported in the open position by a gas spring and protects the inlet plugs from the elements. It should be closed and latched at all times. It should only be open when making the connection to shore utilities.

The compartment below the sunpad provides storage for the shore cords, water hose, and fenders. It is drained by gravity to the engine hatch drain system. Gas charged springs on the storage compartment hatch help lift the hatch and support it when it is in the open position. A lift to release latch secures the hatch when it is closed and a LED light comes on when it is open.



328SS Sunpad Storage Compartment



Stern Compartment With Shore Connections



WARNING



DO NOT STORE FUEL OR FLAMMABLE LIQUIDS IN THE TRANSOM STORAGE COMPARTMENT. VENTILATION WAS NOT PROVIDED FOR EXPLOSIVE VAPORS.

Helm Seat

The helm seat is equipped with a flip up bolster to provide more room between the seat and the helm. The bolster converts the seat to a leaning post style seat with a backrest and allows the operator to sit or stand at the helm. To convert the seat to a leaning post, lift the front of the seat cushion to raise the bolster and push it back above the seat cushion.

The seat is mounted on a slide track that allows the seat to move fore and aft. Pull the lever located at the port front side of the seat base to release the slide track and adjust the seat to the desired position. Release the lever to lock the seat in position.

Two arm rests on each seat provide a more comfortable driving position and swing up into the backrest cushion to make it easier to enter and exit the helm area.

FWD/Aft Facing Lounge Seat

The port side lounge seat is equipped with backrest cushions on the aft and forward ends of the seat. There is a folding armrest on the rear cushion.

Starboard Aft Facing Seat

The starboard aft facing seat is located aft of the helm seat. A storage compartment is located in the seat base below the removable seat cushion. The front of the cushion is secured with special friction latches that require a firm upward pull to release and a firm downward push to latch the seat.

There is a padded armrest with a cup holder and storage compartment that drain to the cockpit on the forward side of seat.



328SS Helm Seat - Bolster Down



Aft/Forward Facing Passenger Seat



Aft Facing Seat

Helm

The steering, engine control, engine instruments and switches for exterior equipment and navigation lights are located on the helm station. The helm station is designed to provide good visibility, room for electronics and a functional control station.

The steering wheel is located on the rear of the helm console. The engine shift and throttle control is on the side of the cockpit, next to the helm. The helm switch panels are on each side of the steering wheel and the engine ignition switch is located on the helm below the steering wheel. The circuit breakers or fuses for the helm activated accessories are located in a panel mounted behind the helm accessed through the head compartment. Molded-in electronics storage is located in the center of the helm, forward of the steering wheel.

An optional GPS/chart plotter/depth sounder may be installed in the helm and an electronic depth sounder with a shallow water alarm is standard. Electronic navigational equipment manufacturers provide detailed instruction manuals with their products. You should read them carefully and review the operation of the electronics with your dealer at the time of delivery.

The back of the helm station is accessed by opening the hinged access door in the head compartment bulkhead. The door provides access to service the helm equipment, accessory switch panels and other components installed in the helm. The fuses that protect the circuits activated by the helm switches and the power management module are also located in this compartment.

Walk-through Door

An acrylic door on the side of the walk-through is used to close off the walk-through area below the opening windshield panel when desired. It is designed to "nest" into a recess on the port side of the walk-through when it is open. To secure the door in either position, push the door until the latch catches.

The door could be damaged or hurt a passenger by the motion of the boat if it is allowed to swing free. Always make sure it is latched in either the open or closed position in rough water or when the boat is underway.

Periodically clean and lubricate the latches to protect them from corrosion and help keep them operating properly.



328SS Helm



328SS Walk-through Door

In-Floor Storage Compartment

There is a large storage compartment located below the cockpit floor between the helm and passenger seats. The compartment drains to the bilge and is equipped with "dry deck" padding to allow for better drainage and air circulation in the compartment. A drain rail around the hatch channels water away from the compartment to the bilge.

A gas spring holds the hatch in the open position and a flush twist latch holds it closed. The handle on the twist lock latch remains up when the latch is not secured. Always make sure the hatch is closed with the latch in the secured position and the handle folded flush before operating the boat above idle speed.

Head and Cabin Compartment Doors

Each door and hatch are made of acrylic plastic glass. The one piece hatch is supported in the open position by two gas springs and latches to the door with a lockable latch when closed.

The door is hinged and swings open against the side of the walk-through. A magnetic latch secures each door in the open position. It is very important that the cabin or head compartment door is secured properly in the open or closed position. The door could be damaged or hurt a passenger by the motion of the boat if it is allowed to swing free. The doors and hatches should be closed and latched whenever the boat is underway. The magnetic latch that holds the doors in the open position could allow them to slam closed in rough water.

When securing the door and hatch, close the door first. Then close the hatch with enough pressure to latch the hatch to the door.

The door and hatch are made of acrylic plastic glass. Acrylic glass scratches easily and can chip. Please refer to the Routine Maintenance chapter for information on the proper care and maintenance of acrylic plastic glass.

Refer to the Interior Equipment chapter for information on cabin and head compartment equipment and operation.



328SS In-Floor Storage Compartment



328SS Head & Cabin Compartment Doors

WARNING

NEVER LEAVE THE HEAD OR CABIN DOOR UNLATCHED. THE DOORS ARE HEAVY AND SWING EASILY. IF A DOOR IS LEFT UNLATCHED, IT COULD SWING UNEXPECTEDLY AS THE BOAT ROCKS, DAMAGING THE DOOR OR CAUSING AN INJURY TO A PASSENGER. TO AVOID INJURY TO PASSENGERS OR DAMAGE TO THE BOAT, ALWAYS CLOSE AND SECURE COMPARTMENT DOORS WHENEVER THE COMPARTMENTS ARE NOT BEING USED, THE BOAT IS IN MOTION OR IN ROUGH WATER CONDITIONS.



328SS Bow Seats With Optional Filler Cushions

Bow Seats and Storage Compartments

The bow area is equipped with seats, a grab rail and built in drink holders that drain to the bilge. The anchor locker and retractable forward boarding ladder are located just forward of the bow seating area. The area is illuminated by LED lights recessed into the seat bases. The lights are activated by the Cockpit Lights switch in the helm switch panel.

The optional cockpit table is mounted to a bracket in the cabin, forward of the berth. Refer to the cockpit table section in this chapter for instructions on installing the table.

Seating

The bow seat area is equipped with a molded in, rear facing bench seat with storage below the seat cushion. There are also forward facing seats on each side with folding armrests forward of the windshield. Removable filler cushions that convert the seating area to forward or aft facing lounge seats are an available option. The removable filler cushions are stored in the cabin when not being used. The seat cushions rest on molded fiberglass supports at the front of the forward facing seats and rear edge of the bench seat.



328SS Aft Facing Bow Seat

Bow Seating Area Access

The bow seat area is accessed by releasing the two latches on the center windshield panel and opening it. A magnetic stop on the deck automatically secures the windshield section in the open position. Use caution when opening the windshield walk-through. The magnet is very powerful and could cause injury or damage to the deck or windshield if the window is allowed to slam against the stop. To close the windshield panel, pull on the bottom of the panel until the magnetic stop releases. Then close the panel and secure it with the locks. Make sure the center section is properly secured in the open or closed position before cruising. Refer to the Windshield section of

this chapter and the Ventilation chapter for more information on the windshield.

Always make sure the center windshield panel is secured in the open or closed position and that passengers in the bow seating area are properly seated before operating the boat above idle speed. The passengers also should not be restricting the forward visibility of the operator.

WARNING

PASSENGERS RIDING BOW SEATING AREA WHILE CRUISING COULD RESTRICT THE OPERATOR'S VISIBILITY. THIS IS A FREQUENT CAUSE OF ACCIDENTS. POSITION PASSENGERS SO THEY DON'T BLOCK THE OPERATOR'S VISIBILITY OR MOVE THEM TO SEATS IN THE MAIN COCKPIT WHILE THE BOAT IS CRUISING.

Wet bar

The wet bar is equipped with a sink or optional electric grill, cup holders and a refrigerator. The counter top and sink cover is made of Karadon. A grab rail on the wet bar provides a hand hold when moving about the cockpit.

The sink is plumbed to the fresh water system and is drained by gravity to a thru hull fitting in the hull side above the waterline. To use the sink, open the hinged lid. Then rotate the faucet to the operating position and make sure the Water Pump breaker in the cabin DC breaker panel is on. The faucet works like faucets in your home when the fresh water system is activated. Always lower the faucet to the stored position and close the lid when the sink is not being used.

A refrigerator is mounted in the wet bar below the sink. The dual voltage refrigerator will operate on 120 volt AC or 12 volt DC power. The refrigerator switches to 12-volt DC automatically when the AC power is disconnected and the Cockpit Refrigerator breaker is activated on the cabin DC panel. When 120 volt AC current is provided by the Cockpit Refrigerator circuit breaker on the 12 volt panel, the refrigerator automatically switches to AC power.

Care should be exercised while operating the refrigerator on 12-volt power without the engines running. It draws a substantial amount of current and can severely drain the house battery through extended use. The refrigerator door has a special latch to secure the door while under way. Make sure the door is properly secured whenever the boat is moving.

Refer to the refrigerator owner's manual for additional operating and maintenance instructions.

Electric Grill (Optional)

An electric, stainless steel grill can be installed in a compartment below the helm seat as optional equipment. The grill operates on 120 volt AC power only from shore power, optional generator or a 12 volt DC to 120 volt AC inverter. Refer to the Electrical systems chapter for additional information on the 120 volt AC electrical system or using the inverter to power the grill.



328SS Wet Bar



328SS Cockpit Grill

The grill is mounted on a slide track behind a door secured with a push to close latch. Pull the latch handle to release the latch, open the compartment door and slide the grill out. To close, push grill and slide it in until it stops. Then close and latch the door. Periodically clean and lubricate the latch to protect it from corrosion and help keep it operating properly.

To use the grill, make sure the Electric Grill breaker in the cabin AC panel is on and open the lid. Use the grill touch control pad located in the cockpit near the battery switch panel to activate the burner and control the temperature. After cooking, be sure the burner is turned off and allowed to cool before closing the lid. Never close the cover while the grill is hot. Turn the Electric Grill breaker in the cabin AC panel off whenever the grill is not being used to ensure it is not activated accidentally.

After cooking, be sure the burner is turned off and the grill is allowed to cool before storing the grill in the storage compartment. Once the grill is cool to the touch, it can properly stored.

Refer to the grill manufacturer's operating manual for additional operating and safety instructions before operating the grill.

Portable Propane Grill

A portable propane gas grill is an available option on 328SS models. Propane fuel for the grill is usually provided by 1 lb disposable propane fuel canisters. The fuel canisters are sold separately and were not included with the grill.

Portable gas grills can be a fire hazard if not used properly and are not intended for use in the cockpit. The grill should only be used on the special grill pedestal mounted on the swim platform or onshore in an open, uncovered area. When using the grill on the swim platform, make sure the "S" shaped pedestal is rotated such that the grill is over the water so grease drippings fall to the water and not onto the swim platform.

Always make sure the grill is allowed to cool and that the propane fuel canister is removed and capped before storing the grill and fuel canister onboard the boat. Propane fuel is very flammable and must be used and stored properly. Refer to the grill manufacturer's operating manual for additional safety and operating instructions before using the propane grill.



328SS Remote Grill Control Panel
Near Battery Switch Panel In Cockpit



WARNING



PROPANE GAS IS EXTREMELY FLAMMABLE AND CAN CAUSE A FIRE OR AN EXPLOSION THAT WILL RESULT IN SEVERE INJURY OR DEATH IF IT IS NOT STORED AND USED PROPERLY. REMEMBER THAT PROPANE VAPOR IS HEAVIER THAN AIR AND CAN SETTLE AND ACCUMULATE IN UNVENTILATED COMPARTMENTS OR IN THE BILGE.

PROPANE FUEL CANISTERS MUST BE DISCONNECTED FROM THE GRILL AND PROPERLY STORED IN A COCKPIT STORAGE COMPARTMENT THAT IS ABOVE THE COCKPIT SOLE. THE COMPARTMENT MUST BE DRY WITH NO ELECTRICAL COMPONENTS OR SWITCHES ON OR IN THE COMPARTMENT THAT COULD CAUSE A SPARK. NEVER STORE PROPANE FUEL CANISTERS IN THE CABIN, HEAD COMPARTMENT, ENGINE COMPARTMENT, BILGE OR A COMPARTMENT BELOW THE COCKPIT SOLE.

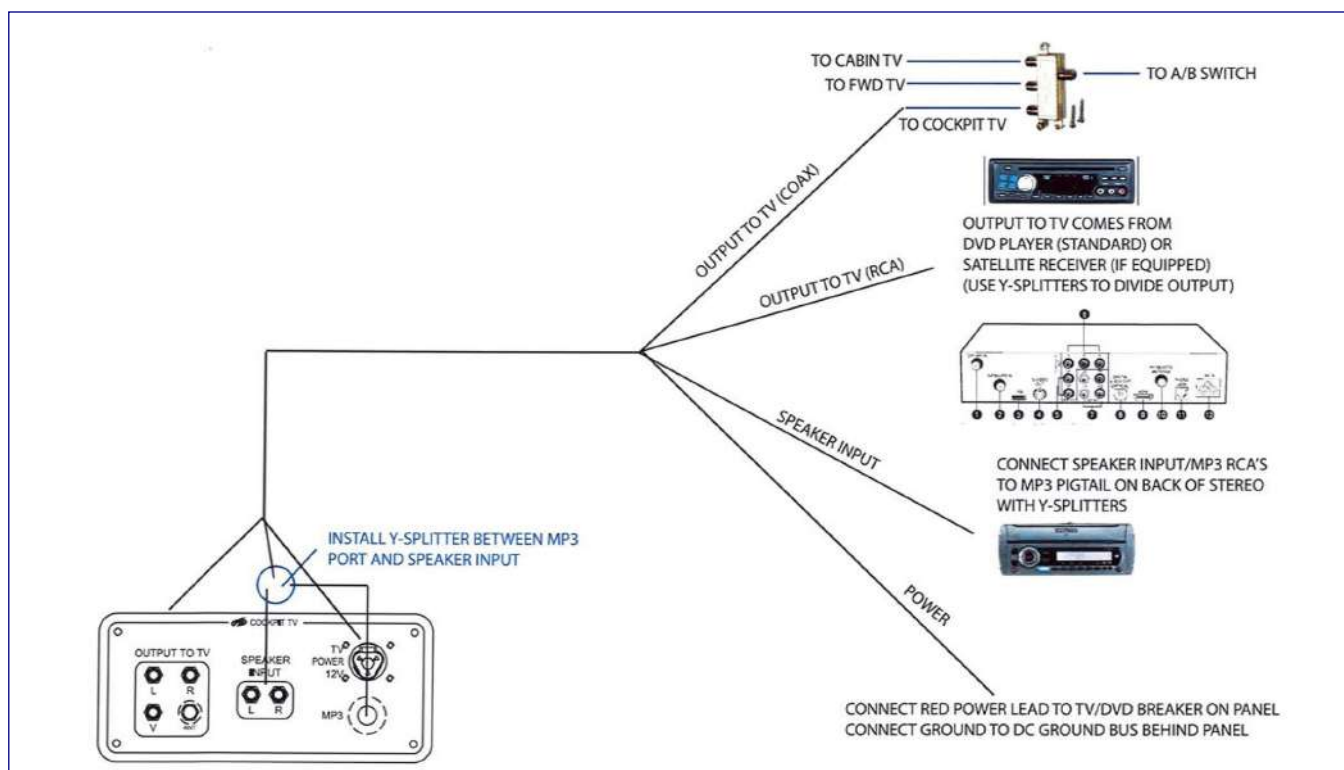

TV Harness Panel In Battery Switch Panel

Cockpit TV

A 12 volt DC Flat screen TV or TV/DVD is available as optional equipment. The TV mounts to a special bracket on the radar arch. A special electrical harness connects the TV to a receptacle panel located in the battery switch panel. When this option is installed, the battery switch panel door will have a cutout that enables the door to be closed when the TV harness is plugged into the panel.

The TV comes with a special waterproof case that allows the TV to be stowed in any convenient compartment on the boat. To mount the TV, remove the table from the case. Pull the safety pin in the side of the arch mounting bracket and slide the bracket on the TV firmly into the arch mount. Release the pin and make sure it extends into the TV bracket to secure the TV to the mounting bracket. Plug the color coded connectors on the harness into the receptacles on the battery switch panel. Reverse the process to remove the table.

The TV should only be used while at running at slow speeds, at the dock or at anchor. Always remove and properly stow the TV in the waterproof case before cruising.



Typical 328SS Cockpit TV

11.8 Bimini Top & Optional Canvas

The canvas for Monterey boats is custom fit to each boat. An optional bow cover protects the seats and equipment forward of the windshield. The bimini top and boot is standard equipment on most models and designed with a relatively flat profile and a snug fit. The canvas is fit to the boat at the factory and the bimini top must be installed properly in order for the optional clear connector and side curtains to fit.

To install the Bimini top, attach the main legs to the deck hinges using the quick release pins and leave the rear stanchions loose. Next, open the bimini and attach the front straps to the metal eye straps on the top of the windshield frame. Attach the rear stanchions, one at a time, to the rear deck hinges located near the rear of the windshield. Use your body weight on the rear corner of the bimini to pull down and stretch the fabric until the stanchion eye end lines up with the hole in the deck hinge. Secure each eye end to the deck hinge with the quick release pins. If the top is still adjusted to factory specifications, the top will be level and the canvas tight.

NOTICE:

The front straps of the bimini must be secured to the windshield before the rear stanchions are secured to the deck. If the rear stanchions are secured first, it will be very difficult to secure the front straps without loosening them. If the front straps are loosened, the bimini top will be too loose and the clear connector and side curtains will not fit properly and appear to be too short.

Bimini Top Enclosure

A clear connector, side curtains and aft curtain is an available option on most models. If your boat is equipped with enclosure curtains, they must be installed in the proper sequence.

Close the center windshield section and attach the clear connector to the zipper at the front of the top and snap it to the top of the windshield frame beginning with the center snaps. If the bimini top is adjusted properly, the clear connector will have to be stretched just enough to pull out the wrinkles and reach the snaps on the windshield. The front straps will continue to bear the main load of the top.

Once the clear connector is completely installed, the side curtains can be put on. Attach the side curtains to the zippers on the sides of the bimini and to the front connector. Snap the curtains to the windshield and the deck beginning with the forward snaps on the windshield. If the bimini is adjusted properly, the side curtains will have to be stretched slightly to pull out the wrinkles and reach the snaps. The main load for the top should remain on the front straps and the rear stanchions.

If you have the optional drop curtain, attach it to the zipper on the back of the top and to the rear of the side curtains. Snap the drop curtain to the deck and cockpit.

There is a panel in the clear connector that can be rolled up and secured by straps near the top of the bimini. This roll up panel allows the walk-through feature of the cockpit and windshield to be used when the bimini and clear connector are installed.

The side curtains and clear connector should be stored either rolled or flat, without folds or creases. Folding the curtains will make permanent creases that could cause the vinyl to crack.

NOTICE:

Cold weather can make the clear vinyl material on the curtains stiff and difficult to stretch to the snaps. This can particularly difficult with new canvas that has been stored off the boat. Laying the curtains in the sun for 30 minutes during the heat of the day will make installing them much easier in cold weather.

11.9 Radar Arch

An aluminum or fiberglass arch with a ski tow is optional on 268SS/288SS models and a painted aluminum arch without a ski tow is standard on the 328SS.

The Arches equipped with a ski tow are designed for pulling one average sized skier or wakeboarder. You should never tow more than one skier or wakeboarder from the any tower or arch. Towing more than one skier will put too much strain on the fabrication and could cause damage to the arch and deck. Refer to the Transom Ski Tow section in this chapter for more information on using the arch or transom ski tow fitting.

The warranty for the arch will be void if it is modified in any way or overloaded by towing too many skiers or wakeboarders. Additionally, if items like antennas, spotlights and other accessories are mounted improperly or in the wrong location, the warranty could be void. If you intend to add equipment or make modifications to the arch, you should contact your dealer or Monterey Customer Service to make sure the equipment you would like to add or the intended modification will not void the warranty on the arch.

Aluminum Arches

Two aluminum arches are available. One type is made of welded anodized aluminum tubing. It is designed to accommodate the canvas top, radio antennas and navigation lights. It is also equipped with a ski tow designed for towing one average sized person.

The other type of arch is a welded aluminum frame covered with a smooth painted aluminum skin. It is designed to accommodate the canvas top, radio antennas and navigation lights. It is also equipped with a ski tow designed for towing one average sized person.

NOTICE:

The painted aluminum arch for the 328SS is not equipped with a ski tow.

Special care must be taken when mounting additional hardware on an aluminum arch, particularly in saltwater. Fasteners will require fiber washers and sealing with caulk or Tef Gel to isolate the fastener from the aluminum and prevent damage to the paint or anodizing when the fastener is installed. Periodically applying automotive or boat wax to the painted arch will provide additional protection from the harsh effects of saltwater and ultraviolet rays. The arch should be washed with soap and fresh water after each day of boating in saltwater. Refer to Anodized Aluminum or Powder Coated and Painted Aluminum in the Routine Maintenance chapter for additional information on maintaining aluminum fabrications.

The arch is mounted to special fasteners bolted to the deck with stainless steel bolts and designed to rotate forward to reduce the clearance height required for covered storage or trailering. A stainless steel safety cable hidden inside each side of the arch prevents it from rotating too far and damaging the windshield and/or arch. To fold the arch, loosen the forward bolts slightly, then remove the rear bolts. Have someone support the arch as the last rear bolt



268SS Anodized Aluminum Arch



328SS Painted Aluminum Arch



288SS Painted Aluminum Arch Folded Down

is being removed to take the strain off the bolt and prevent the arch from dropping suddenly when the bolt is removed. Once the bolt is removed, slowly lower the arch until it is supported by the cables in the down position. Reverse this process to raise the arch and tighten the bolts securely.

Don't overtighten the mounting bolts and never use impact wrenches and power tools on the bolts. The bolts and fasteners are stainless steel which will cause the bolt threads to gall if the bolts are turned too fast by power tools. Galling is the term for thread damage that occurs from heat build up in the threads of stainless steel fittings as they are tightened. Galling will destroy the threads and lock up the fasteners before they are tight, destroying the fasteners and rendering them unusable.

NOTICE:

A special welded bracket that supports the arch is standard with the arch option and must be used if the arch is rotated forward while trailering.

Fiberglass Electric Folding Arch (268SS/288SS)

A folding fiberglass arch is available as optional equipment on the 268SS and 288SS. The arch is folded or raised by electric actuators in each side of the arch that are activated by the Folding Arch switch in the battery switch panel. The actuators lower or raise the arch and secure it in the selected position. A "push to reset" circuit breaker in the battery switch panel protects the circuit for the folding arch.

The arch is designed to accommodate the canvas top, radio antennas and navigation lights. It is also equipped with a ski tow designed for towing one average sized person.

The rocker switch that controls the arch is an ON-OFF-ON momentary rocker switch. Press the top of the switch to raise the arch. Press the bottom of the switch to lower the arch. The switch automatically returns to the OFF position when it is released. Limit switches automatically stop the arch when it reaches the full up or full down positions.

To lower the arch, make sure the forward and rear canvas top sections are folded to the arch or removed. Make sure the house battery switch is ON then press and hold the bottom of the Folding Arch switch until the arch is in the full down position and the actuators stop. To raise the arch, press and hold the top of the switch until the arch is in the full up position and the actuators stop.

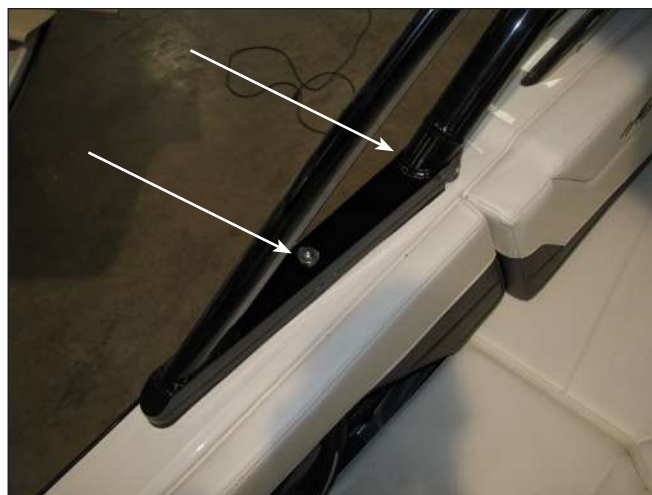

Anodized Aluminum Arch Mount Bolts



Painted Aluminum Arch Mount Bolts



Fiberglass Electric Folding Arch & Actuators

NOTICE:

A special welded adjustable height bracket that supports the arch is standard with the folding arch option and must be used if the arch is lowered to the down position while trailering.



Arch With Front & Rear Top Sections



Arch With Rear Top Section & No Front Section

Arch Convertible Top Enclosure

The canvas for Monterey boats is custom fit to each boat. The convertible top is designed with a relatively flat profile and a snug fit. The canvas is fit to the boat at the factory and the top must be installed properly in order for the optional clear connector and side curtains to fit.

NOTICE:

The following instructions are general and the procedure for installing the canvas on your boat may vary slightly from those described in this section. Contact your dealer for specific instructions to install the canvas on your boat.



Rear Top Folded to Arch

The front and rear sections of the top are folded against the arch and covered with storage boots when the top is in the folded or down position. To open the rear top, remove the boot on the rear portion of the top and zip the top to the zipper on the rear of the arch. Open the top by pulling



Rear Top Folded Open



Rear Top Stretched Tight With Adjustable Stanchions on Each Side of Main Bow



Adjustable Stanchion Supporting Rear Top Section



Center Adjustable Stanchion Supporting Rear Top Section

the main bow towards the rear of the boat until it stops. Remove the quick release pins on the deck hinges for the stanchions that are mounted on the arch and release the Velcro straps or plastic retainers securing the stanchions to the main bows. Then attach the adjustable stanchions to the deck hinges. Secure each stanchion socket to the deck hinge with the quick release pins. Use your body weight on each rear corner of the top to pull down and stretch the fabric until the spring loaded button in the inner stanchion tube lines up with the hole in the outer tube and locks into place. The top canvas should be stretched tight when both stanchions are locked in the out position.



Deck Hinge & Quick Release Pin

NOTICE:

Some rear arch tops have one adjustable stanchion that runs from the center of the main bow to the center of the arch. The center stanchion folds to the main bow when the top is folded against the arch.

To open the front top, remove the boot on the front portion of the top and zip the top to the zipper on the front of the arch. Release the stanchions from the lower deck hinges and open the top it by pulling the main bow towards the front of the boat until it stops. Use your body weight on each side of the top bow to pull down and stretch the fabric until the stanchion socket will fit into the upper deck hinge on the forward side of the arch. Repeat on the other side and secure each stanchion socket to the deck hinge with the quick release pins. The top canvas should be stretched tight when both stanchions are secured in the upper deck hinge.



Front Top Open & Supported With Stanchion

Close the center section of the windshield and attach the clear connector to the zipper at the front of the top or arch and snap it to the top of the windshield frame beginning with the center snaps. If the top is adjusted properly, the clear connector will have to be stretched just enough to pull out the wrinkles and reach the snaps on the windshield. The front bow will continue to bear the main load of the top.

NOTICE:

Some models there is no front top and the clear connector will attach directly to the arch.

Once the clear connector is completely installed, the side curtains can be put on. Attach the forward side curtains to the zippers on the sides of the top and to the front connector. Snap the curtains to the windshield, deck and arch beginning with the forward snaps on the windshield. If the top is adjusted properly, the side curtains will have to be stretched slightly to pull out the wrinkles and reach the snaps. The main load for the top should remain on the bows and the arch.

If you have the optional drop curtain and rear enclosure, attach it to the zippers on the rear of the top and side curtains. Then snap the drop curtain to the arch and deck beginning with the forward snaps on the arch.

There is a panel in the clear connector that can be rolled up and secured by straps on the forward top. This roll up panel allows the walk-through feature of the cockpit and windshield to be used when the top and clear connector are installed.

The side curtains and clear connector should be stored either rolled or flat, without folds or creases. Folding the curtains will make permanent creases that could cause the vinyl to crack.

NOTICE:

Cold weather can make the clear vinyl material on the curtains stiff and difficult to stretch to the snaps. This can be particularly difficult with new canvas that has been stored off the boat. Laying the curtains in the sun for 30 minutes during the heat of the day will make installing them much easier in cold weather.



Open Front Top Section Supported With Stanchions on Each Sided



328SS Arch Canvas & Connectors Installed
Note that front clear connection attaches directly to arch

11.10 Aftermarket Arch

Monterey does not recommend installing an aftermarket wakeboard tower, hardtop or arch. An improperly designed or installed fabrication can cause structural damage to the deck and void the Monterey Limited Warranty. Additionally, Monterey will not be responsible for any damage resulting from the installation of a fabrication not installed at the Monterey factory. If you intend to install an aftermarket hardtop or arch on your boat, please contact your authorized Monterey dealer.

Refer to the Routine Maintenance section for more information on maintaining aluminum fabrications and precautions for adding additional equipment and fasteners.

THIS PAGE WAS LEFT BLANK
INTENTIONALLY

INTERIOR EQUIPMENT

12.1 Head Compartment

Head Compartment

268SS, 288SS and 328SS models are equipped with a head compartment. The compartment is equipped with a sink that has a retractable water hose and spray handle. 328SS models have cold and hot water faucets and an overboard sump pump for the drain. 268SS/288SS models have cold water showers and the compartment drains to the bilge.

The vanity counter top is made of Karadon and there is storage below the sink and the vanity. Lighting is provided by a 12 volt overhead light activated by the light switch on the side of the light fixture.

Ventilation into the compartment is provided by a port window on the 328SS and an opening overhead vent in the 288SS. Refer to the Ventilation chapter for more information on the port window and overhead vent.

The vanity door and other cabinets in the compartment are secured with a dual action, push to lock latch. To open a cabinet door, push on the latch knob. The knob is spring loaded and will pop out one inch, providing a finger hold and release the dead bolt on the latch mechanism. A slight pull is required to release the friction latch and open the door. The door will be held closed by the friction latch while at anchor or at the dock. To close and secure the door for cruising, make sure it is completely closed and push the knob in. The knob will stay in and the locking mechanism will be activated.



328SS Head Compartment

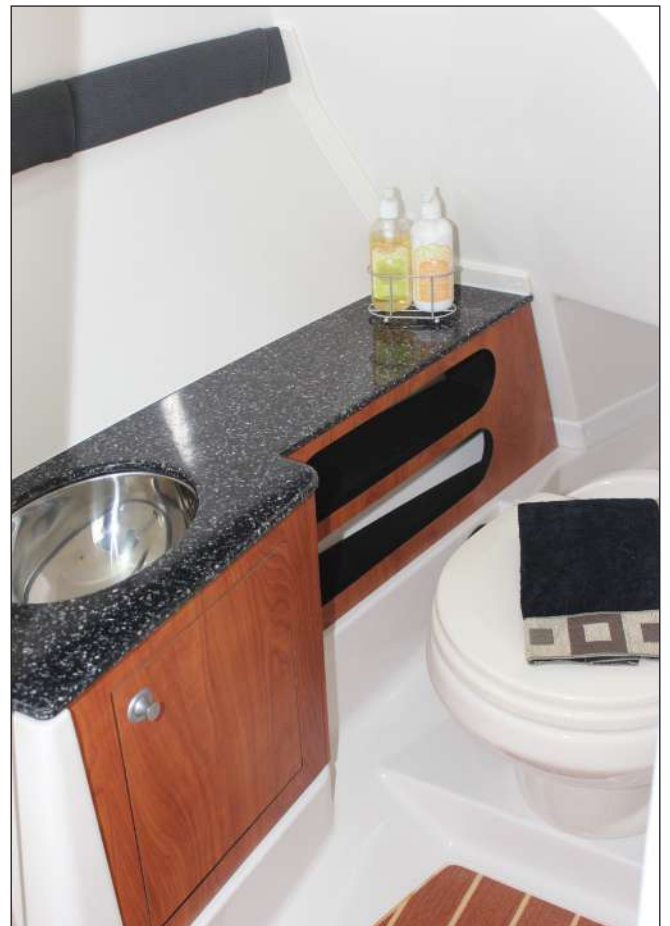

268SS/288SS Head Compartment



328SS Faucet/Spray Head



268SS/288SS
Faucet/Spray Head

An access panel at the rear of the 328SS head compartment provides access to the back of the helm panel and to the fuses in the power management module.

12.2 Marine Head Systems

Portable Head System

The portable head is standard on 268SS/288SS models. The system is made up of two major components, an upper tank and a lower tank. The upper tank contains the fresh water supply, a bellows pump, a seat and the lid. The bottom tank contains the flush valve, waste holding tank, a chemical storage compartment and the drain nozzle. The components are secured together by a clamping mechanism when the portable head is ready for use.

In some areas the law requires that portable heads be equipped with an optional permanent deck mounted pump out system to evacuate the waste with a dockside pump. Boats with a portable head pump out will be equipped with a deck fitting marked "WASTE" located on the deck. Since this system is required to be permanent, the bottom waste tank cannot be removed and the only way to evacuate the system is by a dockside pump.

To use the portable head, add the recommended amount of holding tank deodorant to the waste tank and fill the fresh water tank. To flush after use, pull the waste valve handle straight out, then press the flushing bellows one or more times to rinse. To close and seal the waste holding tank, simply push the valve handle all the way in. Monitor the level in the waste tank and empty as necessary.

Portable Toilet Maintenance

To keep your portable head operating properly it must be emptied and properly cleaned periodically. Please refer to the manufacturer owner's manual for detailed instructions on the proper operation of your portable head.

NOTICE:

In some areas the law requires a waste pump out system on portable heads. If your boat is equipped with the waste pump out, make sure you know the laws for the areas in which you boat before modifying or removing the pump out system.



Typical Porta Potty

The portable head must be properly winterized before winter lay-up or for cold weather use. Please refer to the manufacturer owner's manual for winterizing and cold weather instructions

Porcelain Marine Head System

A 12 volt electric marine toilet is provided as optional equipment on 268SS/288SS and is standard on 328SS models. The toilet is connected to the pressurized fresh water system which results in less odor in the head compartment. It has an automatic pumping device that fills and empties the bowl. Once a button on the control is pressed, the entire cycle is completely automatic. Additionally, the system uses very little water, approximately 2.27 quarts (2.5 liters) per flush.

To use the toilet, make sure the Head System and Water System switches and/or circuit breakers are on. Then press the "Add Water" button on toilet control panel to add a preset amount of water to wet the bowl which prevents organic residues dirtying the ceramic sides. After using the toilet,

pressing the "Flush" button starts an automatic flushing cycle that moves the waste to the holding tank and leaves the bowl completely clean and dry in the rest position. A warning light in the control panel illuminates when the holding tank is full and flushing is not recommended.

The head contains an integrated, high-speed turbine grinding pump that transfers waste to the holding tank where it remains until it is pumped out by a waste dumping station or the overboard diaphragm discharge system.

Please refer to the toilet manufacturer owner's manual for more information on the operation of the marine head system.



Porcelain Marine Toilet

NOTICE:

In many areas it is illegal to flush head waste directly overboard. Violation of these pollution laws can result in fines or imprisonment. Always know the law for the areas in which you boat. Never dump head or holding tank waste overboard illegally.

Head System Holding Tank

The holding tank is located in the bilge below the cockpit floor or in the engine compartment. When the tank is full, the light on the toilet control panel will be lit, indicating that flushing is not recommended. The tank must either be pumped out by an approved waste dumping station through the waste deck fitting or the optional overboard discharge pump.

To pump out the holding tank with the overboard waste discharge system, open the valve at the discharge thru-hull fitting in the forward bilge or engine compartment and activate the momentary switch in the Overboard Discharge switch panel. Monitor the fluid level closely as the tank is pumped. Release the switch and to turn off the discharge pump when pumping is complete, then close the ball valve at the thru-hull fitting.





TECMA Control Panel

NOTICE:

Monitor the pumping operation as the overboard discharge drains the holding tank. Be prepared to turn the pump off immediately when draining is complete.

NOTICE:

In order to comply with current State, Federal and Coast Guard regulations, the Overboard Discharge Valve must be off and secured with a lock or wire cable tie strap whenever the boat is operating in areas in which the discharge of sewage is prohibited.

	CAUTION	
<p>IN MANY AREAS IT IS ILLEGAL TO PUMP HEAD WASTE DIRECTLY OVERBOARD. VIOLATION OF THESE POLLUTION LAWS CAN RESULT IN FINES OR IMPRISONMENT. ALWAYS KNOW THE LAW FOR THE AREAS IN WHICH YOU BOAT. NEVER DUMP HEAD OR HOLDING TANK WASTE OVERBOARD ILLEGALLY.</p>		



328SS Holding Tank & Charcoal Filter

Head System Maintenance

The head should be cleaned and inspected for leaks regularly.

The holding tank should be pumped out and flushed as needed. Periodically add chemical to the holding tank to help control odor and to chemically break down the waste. See the head manufacturer owner's manual for additional operating and maintenance information.

The vent hose for the holding tank is equipped with a charcoal filter to reduce odor from the holding tank. The filter should be changed once a year or if the holding tank has become overfilled, which will plug the filter and could cause damage to the waste system.

NOTICE:

The head system must be properly winterized before winter lay-up. Please refer to the Seasonal Maintenance chapter and the manufacturer owner's manual for winterizing instructions.

10.3 Cabin (328SS)

The cabin is located on the port side, forward of the passenger seat. It is equipped with a berth, entertainment center and microwave. Storage for dunnage is below the berth and a storage bracket the optional cockpit table and drink holders are located at the end of berth. The optional cabin air conditioning unit is located in a compartment below the front of the berth. A reading light, the air conditioner control panel and a 120 volt LCD television are on the front bulkhead.

Daylight and fresh air are provided to this area by the cabin door and an opening port window. The window opens to the cockpit walk-through and is equipped with a removable screen. Refer to the Ventilation System chapter for more information on operating port windows.

The counter top at the front of the berth and below the TV made of Karadon. A microwave oven, 120 volt outlet, 12 volt outlet, entertainment center, AC/DC electrical panels, antenna gain control panel and the optional air conditioning control panel are built into the forward bulkhead.

Microwave Oven

A microwave oven is provided as standard equipment. It operates on AC power and is protected by the Microwave breaker in the AC breaker panel. Please refer to the microwave a owner's manual for detailed information on the microwave oven installed in your boat.

Cabin Circuit Breaker Panels

The cabin AC/DC breaker panels are built into a cabinet on forward bulkhead. Refer to the Electrical Systems chapter for additional information on the AC/DC panels.

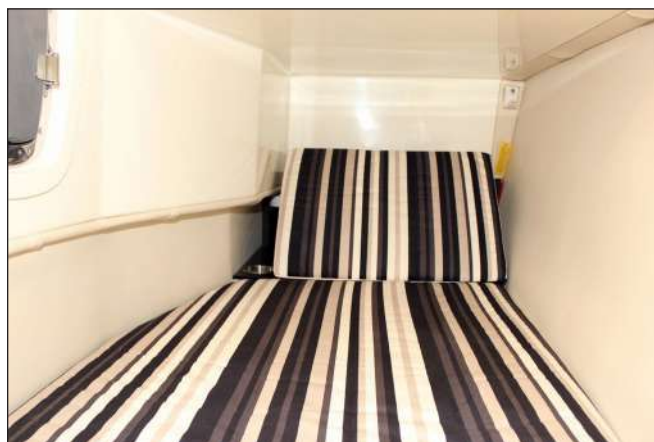

Berth & Carbon Monoxide Detector



AC/DC Panels, Entertainment Center, Antenna Gain Control Panel & Microwave



Stereo & DVD/CD Player

Entertainment Center

A DVD/CD player, stereo and 12 volt TV are built into the cabinet near the breaker panels. The DVD/CD player and TV are activated by the TV/DVD breaker and the stereo is activated by Stereo breaker in the DC panel.

Refer to the operation manuals for the stereo, DVD/CD player and TV for operating instructions.

Cabin Light Switches

The cabin lights are controlled by switches on the light fixtures.

Carbon Monoxide Detector



A carbon monoxide (CO) detector is installed on the aft bulkhead above the berth. If excess carbon monoxide fumes are detected, an audible beeping will sound indicating the presence of the toxic gas.

A by-product of combustion, carbon monoxide is invisible, tasteless, odorless, and is produced by all engines, heating and cooking appliances. The most common sources of CO on boats are the engines, auxiliary generators and propane or butane stoves. These produce large amounts of CO and should never be operated while sleeping.

Please read the owner's manual supplied by the detector manufacturer for operation instructions and additional information regarding the hazards of carbon monoxide gas. Also read more about carbon monoxide, carbon monoxide detectors, and proper ventilation in the Ventilation Systems and Safety Equipment chapters in this manual. This is especially essential if your boat is equipped with the optional generator. If you did not receive a manual for your carbon monoxide detectors, please contact the Monterey Boats Customer Service Department.



Carbon Monoxide Detector

	WARNING	
<p>ACTIVATION OF THE CARBON MONOXIDE DETECTOR INDICATES THE PRESENCE OF CARBON MONOXIDE (CO) WHICH CAN BE FATAL. EVACUATE THE CABIN IMMEDIATELY. DO A HEAD COUNT TO CHECK THAT ALL PERSONS ARE ACCOUNTED FOR. DO NOT REENTER THE CABIN UNTIL IT HAS BEEN AIRED OUT AND THE PROBLEM FOUND AND CORRECTED.</p>		

Cabin Floors

The galley floor and steps are Lonseal vinyl with teak image and texture. It is important to avoid tracking sand and dirt on the cabin floor and steps. Sand and dirt acts like sand paper and will eventually sand off the finish in the traffic areas.

The floors and steps can be vacuumed and cleaned with a mixture of water and Murphy's Oil Soap. Wipe dry with a clean towel.

The carpeted areas are cleaned and maintained in the same fashion as the carpeting in your home.

Walls, Cabinets and Trim

The hardwood used for the wall trim moldings is finished with a high quality urethane varnish. The walls themselves and the cabinet doors are made of a laminated, simulated wood that requires no maintenance. The walls and molding can be routinely cleaned with a damp cloth. For heavy duty cleaning, use a mixture of water and Murphy's Oil Soap or white vinegar and water to clean the wood or laminate and wipe it dry with a clean towel. Apply a furniture polish to add luster and help to preserve the finish.

10.4 Air Conditioner (328SS)

The cabin air conditioner will operate on either 120-volt AC or 12-volt DC power, depending on the unit selected for your boat. The AC powered unit is equipped with reverse cycle heat and can be operated as a cooling or heating unit. The DC powered unit cools only and will not function as a heating unit.

You should always keep the cabin door closed when operating the air conditioner. If the cabin door is left open, it could cause the air conditioner unit to run continuously and not cycle enough to defrost the coiling condenser. This could cause the coils to develop enough ice to reduce the unit's ability to cool the boat. With DC powered units, leaving the cabin door open will significantly reduce the available operating time while operating the air conditioning on battery power.

The main compressor and air handler is located below the berth in the cabin. The unit creates condensation that drips into the pan at the base of the unit. A hose attached to the pan drains the water to the sump pump system. The sump pump system is activated whenever the house battery switch is on and must be activated when the air conditioner is operating.

It is normal for some water to be in the pan whenever the air conditioner has been used. The condensation pan should be checked periodically to make sure it is draining properly.

The drain hoses, condensation pan and sump should be flushed clean if they become restricted by mold or debris. If the drain becomes plugged, the condensation pan will overflow to the berth storage compartment and could make the cabin floor wet.

The intake line for the seawater pump in the engine compartment is equipped with a sea strainer that must be checked for debris frequently and cleaned as necessary. Refer to the Raw Water System chapter for information on the air conditioning pump and cleaning the sea strainers.

You should also refer to the air conditioner owner's manual for additional operating and maintenance instructions.



Typical 120-Volt Air Conditioner Below Berth



Typical Air Conditioner Control Panel

NOTICE:

Air conditioners use surface water as a cooling medium. The boat must be in the water and the raw water supply system must be properly activated prior to use. Operation without proper cooling could cause the air conditioning unit to shut down and could cause system damage. Always check for proper water flow out of the air conditioning pump discharge thru-hull when the air conditioner is operating.

120-volt AC Air Conditioner Operation

The 120-volt AC air conditioning unit is activated and protected by the Air Cond breaker in the AC breaker panel. It requires 120-volt AC current from shore power or the optional generator. To operate the system, make sure the thru-hull valve for the air conditioner seawater supply pump is on. The pump, valve and sea strainer are located in the engine compartment bilge. Turn the Air Cond breaker in the AC breaker panel ON. The air conditioning or heat then will be controlled by the electronic control panel in the cabin. When activated, water should continuously flow from the overboard drain thru-hull.

The air conditioning system produces heat when it is operated in the reverse cycle mode. The ability of the unit to produce heat is affected by the temperature of the seawater. As the seawater temperature lowers, the air conditioner's ability to produce warm air decreases. When the seawater temperature drops below 40 - 45 degrees, the unit will not be able to produce heat. You should not operate the air conditioner to produce heat when the water temperature is below 40 degrees.

12-volt DC Air Conditioner Operation

The 12-volt DC air conditioning unit is activated and protected by the Air Cond breaker in the DC breaker panel. It draws 12-volt DC current from the house battery bank. The DC air conditioning unit draws a significant amount of current (approx 30 amps) while operating. To avoid draining the house batteries when operating the system at dockside, make sure the 120-volt AC system is connected to shore power and the battery charger is activated to maintain the batteries.

When operating the system away from the dock, the voltage in the house battery bank must be monitored closely to avoid draining the batteries when the engines or optional generator are not running. If the house batteries are in good condition and no other DC equipment is operating, the DC air conditioner can typically operate approximately 3 to 5 hours before the batteries become drained. If the stereo, cabin and/or cockpit lights, electronics or other DC electrical equipment is being used, the operating time available for the air conditioner will be significantly less.

While underway at cruise speed, the engine charging systems will provide enough current to maintain the batteries with the DC air conditioner operating. The engines may not provide enough



Typical 120-Volt Air Conditioner Pump, Strainer & Thru-Hull Valve

current at idle to maintain the batteries with the air conditioner operating, particularly with the stereo and electronics activated. If your boat is equipped with the optional generator, it should be operating with the battery charger activated to maintain the batteries whenever the air conditioner is activated while operating the boat below cruise speed. Remember that generator engines produce carbon monoxide and should never be operating while the crew is sleeping.

To operate the system, make sure the thru-hull valve for the air conditioner seawater supply pump is on. The pump, valve and sea strainer are located in the engine compartment bilge. Turn the Air Cond breaker in the cabin DC breaker panel on. The air conditioning then will be controlled by the electronic control panel in the cabin. When activated, water should continuously flow from the overboard drain thru-hull.

ROUTINE MAINTENANCE

13.1 Exterior Hull and Deck



Hull Cleaning Below The Water Line



When the boat is removed from the water, clean the outer bottom surface immediately. Algae, grass, dirt and other marine growth is easier to remove while the hull is still wet. Use a pressure cleaner or a hard bristle brush to clean the surface.



Marine Growth, Bottom Paint and Osmosis Blistering

If the boat is to be left in saltwater for extended periods, the hull must be protected from marine growth by antifouling paint. Because of variations in water temperature, marine growth, and pollution in different regions, a qualified boat yard in your area should be consulted when deciding what bottom paint system to apply to your hull. This is extremely important as pollution and marine growth can damage fiberglass hulls.

Your Monterey hull is manufactured using state-of-the-art materials and processes. A layer of super tough, Ashland "AME" Resin with high density and superior adhesion properties provides an exceptionally effective barrier to osmotic blistering. Osmosis is caused by a chemical reaction between water and substances in the hull laminate below the waterline. If water breaches the exterior gelcoat and barrier layer, it can react with the chemical components in the laminate creating acidic substances. These substances create pressure behind the gelcoat which causes blisters.

	CAUTION	
<p>SANDBLASTING THE HULL BOTTOM WILL DAMAGE THE FIBERGLASS. USE A FIBERGLASS WAX REMOVER AND SAND TO SCUFF THE GELCOAT SURFACE. THE INSTRUCTIONS AND RECOMMENDATIONS OF THE BARRIER COATING AND ANTI-FOULING PAINT MANUFACTURERS SHOULD BE FOLLOWED EXACTLY.</p>		

	CAUTION	
<p>BARRIER COATINGS AND BOTTOM PAINT SHOULD BE APPLIED ONLY BY QUALIFIED MARINE PROFESSIONALS IN A BOAT YARD OR DEALERSHIP THAT SPECIALIZES IN THEIR APPLICATION. USE ONLY STANDARD, HIGH QUALITY ANTI-FOULING PAINTS AND BARRIER COATINGS FROM NAME BRAND MANUFACTURERS SUCH AS INTERLUX AND PETTIT.</p>		

	CAUTION	
<p>DO NOT ALLOW THE HULL ANTI-FOULING PAINT TO CONTACT THE OUTDRIVE. MOST ANTI-FOULING PAINTS DESIGNED FOR HULL BOTTOMS CONTAIN COPPER AND CAN CAUSE SEVERE GALVANIC CORROSION DAMAGE TO THE OUTDRIVE UNIT. USE ONLY ANTI-FOULING PAINT DESIGNED FOR OUTDRIVES AND OUTBOARD MOTORS. ALWAYS LEAVE A ONE INCH BARRIER BETWEEN THE HULL BOTTOM PAINT AND OUTDRIVE.</p>		

Most bottom paints require some maintenance. Proper maintenance is especially important when the boat is in saltwater and not used for extended periods or after dry storage. If the hull bottom has been painted with antifouling paint, contact your dealer for the recommended maintenance procedures.

Sacrificial Anodes

Sacrificial anodes are installed on the inboard engine's fresh water cooling system, catalytic converter raw water exhaust manifold and the outdrive. Additional anodes are installed on the trim tab planes.

The anodes are less noble than copper based alloys, aluminum, cast iron and stainless steel. They will deteriorate first, protecting the more noble engine and underwater hardware against galvanic corrosion. Anodes should be checked monthly and changed when they are 75% of their original size. Additionally, anodes that are subjected to frequent wetting and drying require periodic scraping with sandpaper to remove scale and oxidation to maintain their effectiveness.

When replacing the anodes, make sure the contact surfaces are clean, shiny metal and free of paint and corrosion. Never paint over the anode. The bonding system should be inspected by a qualified marine electrician once a year to make sure all connections are sound and there is continuity throughout the system.

Boats stored in saltwater will normally need to have the anodes replaced every 6 months to one year. Anodes requiring replacement more frequently may indicate a stray current problem within the boat or at the slip or marina. Anodes that do not need to be replaced after one year may not be providing the proper protection. Loose or low quality anodes could be the problem. There could also be a problem in the bonding system. Contact your dealer for the proper size and type of anodes to be used and the specific installation procedure.

NOTICE:

Your Volvo Penta or Mercruiser product has been shipped with Aluminum anodes. Aluminum is effective in both saltwater and in fresh water. If you will be boating in saltwater exclusively, we recommend switching the anodes to Zinc. If you will be boating in fresh water exclusively, we recommend switching the anodes to Magnesium. Using the recommended anode is more critical when stainless steel propellers are installed. Consult your dealer or the engine manufacturer for information on the proper anode for your boating area.



Typical Mercruiser Outdrive Anodes



288SS Trim Tab Anode

Fiberglass Gelcoat Surfaces

- Keep the gelcoat surface out of direct sunlight or covered when it is not in use.
- Wash gelcoat frequently (daily in salt or polluted environments) with mild detergent and plenty of fresh water. Remove any stains quickly. Gelcoat is microscopically porous, so long term staining may become permanent.
- Regularly wax gelcoat surfaces with marine grade wax recommended for fiberglass finishes in the spring and fall. (Monthly in salt or polluted environments) The washing and waxing of your boat will have the same beneficial effects as they have on an automobile finish. The wax will fill minute scratches and pores thus helping to prevent soiling and will extend the life of the gelcoat.

DON'TS

- Do not use plastic or other nonporous (non-breathable) materials to cover gelcoat surfaces. Trapped moisture from condensation can cause gelcoat damage. Shrink wrap storage covers must be properly ventilated, including hull sides.
- Do not use abrasives, bleaches, ammonia, acids, harsh detergents or highly alkaline (high PH) cleaners. See your dealer for special marine formulations. Harsh abrasive and chemical cleaners are not recommended because they can damage, stain or dull the gelcoat, reducing its life and making it more susceptible to stains.
- NEVER apply wax or buffing compound to a gelcoat surface in direct sunlight.
- Do not attempt to remove stains and scratches. Chalking, stains, and minor scratches can be removed in most cases with careful rubbing and polishing with appropriate chemicals and is best done by a professional - see your dealer.

After the boat is exposed to the direct sunlight for a period of time, the color in the gelcoat tends to fade, dull or chalk. A heavier buffing is required to bring the gelcoat back to its original luster. For power cleaning use a light cleaner. To clean the boat by hand, use a heavier automotive cleaner. Before cleaning the surfaces, read the instructions given with the cleaner. After cleaning the surfaces, apply wax and polish all fiberglass surfaces except the nonskid areas.

If the fiberglass should become damaged and need repair, contact your dealer for an authorized repair person to make the repairs.

Stainless Steel Hardware

Marine grade stainless steel components such as hardware, cleats, eyes and rails offer superior corrosion resistance. When properly maintained, stainless steel will not rust or stain, even in harsh saltwater environments. However, if not maintained, stainless steel can rust, discolor or even corrode. The following guidelines will help keep stainless steel looking good for years to come.

DO'S

- Clean stainless steel frequently (daily in salt or polluted environments) with mild soap and plenty of water. Any cleaner safe for use on glass is usually safe for stainless.
- Remove rust spots (especially around welds) immediately with a brass, silver or chrome cleaner. Irreversible pitting will develop under rust allowed to remain on stainless for any period of time.
- Remove rust stains on gelcoat. See dealer for recommended product.
- Protect stainless with waxes or polishes suitable for marine use.

DON'TS

- Do not use coarse abrasives like sandpaper or steel wool which may actually cause rusting.
- Do not use acids or bleaches which may etch the naturally occurring protective coating.
- Do not leave stainless steel in contact with iron, steel or other metals which cause contamination leading to rust or corrosion.

GEMPLUX MAINTENANCE INSTRUCTIONS

Job	Cleaning Agents	Method	Comments
Routine Cleaning	Soap and Water	Apply with a sponge or soft cloth. Dry area completely.	Once your stainless is free of discoloration and/or bleeding, spray GEMPLUX Passivation Solution directly onto stainless. Allow to cure for 30-60 seconds. Rinse with fresh water and dry the area. This solution will help re-passivate the stainless steel.
Stubborn stains, discoloration or bleeding	GEMPLUX Cleaning Wax	Apply with soft, dry cloth.	



Gemlux Stainless Steel Hardware

Most of the stainless steel hardware on your boat is made of Gemlux, polished stainless steel. In order to ensure that your Gemlux stainless steel maintains its beautiful finish, it is critical that you care for it properly.



When using the boat in saltwater, the hardware should be washed with soap and water after each use. Frequent cleaning of your stainless steel with soap, water and Gemlux Cleaning Wax will help maintain the finish. Always rinse the metal thoroughly with clean water and dry completely. Clean soft cloths or pads should be used. The use of steel wool pads or other highly abrasive brushes or sponges are not recommended and will damage the surface.

Contamination of the surface by chemicals, dirt or other material hinders the passivation process and traps corrosive agents, thus reducing corrosion protection. If your stainless is exposed to such chemicals it should be re-passivated with Gemlux Passivation solution.

For purchase information on the Gemlux Cleaning Wax or Gemlux Passivation Solution, please contact Gemlux at: Phone: 888-436-5891 Fax: 904-269-5905 or on the web at www.gemlux.com.

	CAUTION	
<p>YOUR STAINLESS STEEL CAN BE DAMAGED BY EXPOSURE TO ACIDS AND OTHER CORROSIVE AGENTS FOUND IN MANY CLEANING PRODUCTS. A PARTIAL LIST OF ADDITIVES THAT MAY CAUSE STAINING AND A WEAKENING OF THE FINISH IS PROVIDED BELOW. USE OF THESE AND OTHER SIMILAR SOLUTIONS TO CLEAN YOUR BOAT CAN CAUSE YOUR STAINLESS STEEL TO BLEED AND WILL VOID YOUR WARRANTY.</p>		

Chlorsuphonic Acid Ferrous Iodide Hydrobromic Acid Iodine Sodium Chlorite Sulphur Chloride Bleach Comet EZ-ON EZ-OFF Cleaner Ferric Chloride Fluorine Hydrofluosilicic Acid Silver Chloride	Sodium Hypochlorite Sulphuric Acid Muriatic Acid On & Off Cleaner Rust StainsAway Ferrous Chloride Hydrochloric Acid Hydrofluoric Acid Sodium Bifluoride Stannic Chloride SnoBol Soft Scrub Marine Spray Nine
---	---



	CAUTION	
<p>UNDER NO CIRCUMSTANCES SHOULD ANY ABRASIVE MATERIALS SUCH AS SANDPAPER, BRONZE WOOL, OR STEEL WOOL BE USED ON STAINLESS STEEL. DAMAGE TO THE HARDWARE WILL RESULT.</p>		

Anodized Aluminum Surfaces

Anodized aluminum should be washed periodically with soap and water to keep it clean. If the boat is used in saltwater or polluted water, the aluminum should be washed with soap and water after each use. Saltwater allowed to remain on anodized aluminum will penetrate the anodized coating and attack the aluminum.

If your boat is used in saltwater and equipped with a wakeboard tower and fiberglass hardtop, it will require special attention to the anodized aluminum just below the top. This area is subject to salt build up from salty condensation and sea spray. It is also frequently overlooked when the boat is washed and will not be rinsed by the rain. Consequently, the aluminum just below the top is more likely to become pitted than the exposed aluminum on the structure. Make sure the aluminum in this area is washed frequently with soap and water and rinsed thoroughly. Pay particular attention to places where the top material contacts the frame.

Once a month coat the entire frame with a metal protector made for anodized aluminum to protect against pitting and corrosion caused by the harsh effects of saltwater. Do not use automotive or boat wax designed for paint or gel coat on anodized aluminum. The wax can contaminate the aluminum and damage the anodized surface.

**CAUTION**

ONE DRAWBACK TO METAL PROTECTORS IS THAT THEY CAN MAKE THE METAL SLIPPERY. THEREFORE, METAL PROTECTORS SHOULD NOT BE USED ON TOWER LADDERS, STEERING WHEELS AND OTHER AREAS WHERE A GOOD GRIP AND SURE FOOTING IS IMPORTANT.

Stains can be removed from anodized aluminum with a metal polish or fine polishing compound. To minimize corrosion, use a caulking compound or Teflon based sealer to bed hardware and fasteners mounted to aluminum fabrications. If the anodized coating is badly scratched it can be touched up with paint. With proper care, anodized aluminum will provide many years of service.

Powder Coated or Painted Aluminum

Powder coated or painted aluminum should be washed periodically with soap and water to keep it clean. If the boat is used in saltwater or polluted water, the aluminum should be washed with soap

and water after each use. Saltwater allowed to remain on powder coated or painted aluminum will penetrate the coating and attack the aluminum, usually around fasteners and hardware mounted to the aluminum.

If your boat is used in saltwater and equipped with a wakeboard tower and fiberglass hardtop, it will require special attention to the aluminum just below the top. This area is subject to salt build up from salty condensation and sea spray. It is also frequently overlooked when the boat is washed and will not be rinsed by the rain. Consequently, the aluminum just below the top is more likely to become pitted than the exposed aluminum on the structure. Make sure the aluminum in this area is washed frequently with soap and water and rinsed thoroughly. Pay particular attention to places where the top material contacts the frame.

Once a month check for damage, scratches and corrosion, particularly around fasteners and hardware. Nicked or badly scratched paint and powder coating can be sanded and touched up with enamel paint. Corrosion around fasteners will have to be sanded, then touched up with paint. The fasteners will require fiber washers and sealing with caulk or a Teflon based sealer to isolate the fastener from the aluminum and prevent damage to the paint or powder coating when the fastener is installed. Periodically applying automotive or boat wax to the surface will provide additional protection from the harsh effects of saltwater.

Always repair scratches, nicks and corroded areas as soon as possible. Corrosion left unaddressed will lift the paint or powder coating, allowing moisture to travel between the coating and the aluminum causing the corrosion to spread below the coating and damage the aluminum.

If excessive chipping and peeling occurs, it could be an indication of an electrical fault in the boat or aluminum fabrication. You should contact a qualified marine electrician to inspect your boat immediately and correct the problem if you suspect that your boat may have a fault in the aluminum frame. You should also contact Monterey Boats Customer Service.

NOTICE:

Boats that are towed behind larger vessels require special attention to the aluminum hardware. The salt spray, salty steam, and chemicals in exhaust gases are particularly corrosive and will eventually penetrate and damage the surface of anodized, painted or powder coated aluminum. It is imperative that the boat and the aluminum are cleaned thoroughly at the completion of each trip or at the end of each day on long cruises to reduce accelerated deterioration of the anodizing or powder coating and premature corrosion to the aluminum.

Chrome Hardware

Use a good chrome cleaner and polish on all chrome hardware.

Acrylic Plastic Glass

Acrylics and Plexiglas have properties that make them ideal for the marine environment. Components such as cabin doors and deck hatches need special care to prevent scratches and other damage. The following guidelines will help keep acrylics and Plexiglas looking good for years to come.

DO'S

- Wash your hatches, windshield connector, side curtains and other clear plastic pieces, as well as other acrylic components on your boat with a mild soap and plenty of lukewarm water.
- Use a clean, soft cloth, applying only light pressure.
- Rinse with clear water and dry by blotting with a damp cloth or chamois.
- Grease, oil or tar may be removed with a good grade of hexane, aliphatic naphtha or kerosene. These solvents may be obtained at a paint or hardware store and should be used in accordance with the manufacturer's recommendations.
- To maintain a high-luster finish on your acrylics, we recommend that after properly cleaning, apply Meguiar's™ Mirror Glaze #10 with a soft towel. Note: If slight scratches appear on acrylics, use Meguiar's™ Mirror Glaze #17

NOTICE:

Clear plastic (Isinglass) is subject to ultra-violet (sunlight) degradation over time. It may turn yellow-brown (a burnt appearance) and get brittle.

Two things that can accelerate this degradation are:

1. Direct contact with aluminum or stainless steel frames. Use "Standoffs."
2. In salt water areas, dried salt crystals on the plastic will amplify sunlight. Wash after each use and/or windy days.

DON'T'S

- Do not subject acrylic material to high temperatures when polishing.
- Do not use glass cleaning sprays, cleaners containing ammonia, scouring compounds, or solvents like acetone, alcohol, gasoline, benzene, carbon tetrachloride or lacquer thinner.
- Do not use masking tapes, duct tapes or packing tapes on your acrylic materials.
- Do not drill holes in your acrylic materials without proper drill bits (special bits are used in acrylic material to avoid damage).

13.2 Upholstery, Canvas and Enclosures Marine Interior Vinyl Upholstery

The vinyl upholstery used on the seats, cushions, bolsters and headliners should be cleaned periodically with mild soap and water. Any stain, spill or soiling should be cleaned up promptly to prevent the possibility of permanent staining. When cleaning, always rub gently. Avoid using products containing ammonia, powdered abrasive cleaners, steel wool, ink, strong solvents, acetone and lacquer solvents or other harsh chemicals as they can cause permanent damage or shorten the life of vinyl. Never use steam heat, heat guns or hair dryers on vinyl.

Stronger cleaners, detergents and solvents may be effective in stain removal, but can cause either immediate damage or slow deterioration. Lotions, sun tan oil, waxes and polishes, etc., contain oils and dyes that can cause stiffening and staining of vinyl.

The following are typical stains and cleaning Tips for marine vinyl:

- For normal cleaning – In general most common stains can be cleaned using warm, soapy water and clear water rinses. Moderate scrubbing with a medium bristle nylon brush will help to loosen soiling material from the depressions of embossed surfaces. For stubborn stains, use commercially available mild detergents in accordance with manufacturers instructions.
- Full strength rubbing alcohol or mineral spirits may be tried cautiously as a last resort on very stubborn stains, if the above suggestions do not work. Indiscriminate use of any solvent or solvent containing cleaner can severely damage or discolor vinyl.

NOTICE:

Certain stains may become permanently set unless they are removed immediately. The procedure for the removal of more severe staining agents are outlined below:

- Ballpoint Ink, Permanent Marker – Ink spots will stain vinyl permanently. Immediate wiping with rubbing alcohol in a well-ventilated area will remove much of the stain.
- Oil based paint – The use of turpentine in a well ventilated area will remove any fresh paint. Dried paint must be moistened carefully with a semisolid gel-type stripper so that the softened paint can be gently scraped away. Rinse with soap and water.

	CAUTION	
<p>DIRECT CONTACT WITH PAINT STRIPPERS WILL REMOVE THE PRINT PATTERN FROM VINYL. PAINT STRIPPERS ARE VERY CORROSIVE. TAKE CARE TO AVOID SKIN CONTACT BY WEARING PROTECTION.</p>		

- Crayon, mustard, ketchup – Sponge with mild soap and water. For stubborn stains that may have set, use a cloth soaked in diluted mild detergent with gentle rubbing. Any remaining stain should be washed with diluted bleach. Rinse repeatedly with clean water.
 - Chewing gum – Scrape off as much as possible with a dull knife. Rubbing with an ice cube will assist and make it easier to remove when scraping. The remaining gum should then be removed in a well ventilated area using a cloth saturated with mineral spirits. Use light rubbing. Rinse thoroughly with clean water.
 - Lipstick, grease, oil, eye shadow, shoe polish – Apply a small quantity of mineral spirits by means of a cloth with gentle rubbing. Take care not to spread the stain by smearing it beyond its original source. No time should be lost in removing shoe polish as it contains a dye that will cause permanent staining. Rinse thoroughly with water.
 - Candy, ice cream, coffee, tea, fruit stains, liquor, wine, suntan lotion, soft drinks. - Use clear lukewarm water and a sponge repeatedly. Any loose material should be gently scraped with a dull knife. Any soiled area remaining after drying should be gently rubbed with a cloth spotted with a mild detergent solution. Rinse thoroughly with clean water.
 - Blood, leaf residue - Sponge the area with a clean cloth soaked in cool water. If stubborn stains remain, use household ammonia and rinse repeatedly with a clean, wet cloth. Do not use hot water or soapsuds, as this will set the stain.
 - Bird excreta, nausea stains - Sponge the area with soapy water containing diluted bleach until the stain is removed. Rinse thoroughly with water.
 - Urine Stains – Sponge with soapy water containing a small amount of household ammonia. Rinse thoroughly with clean water.
 - Surface mildew – Wash with diluted bleach using a soft nylon brush for stubborn growth. Rinse repeatedly with clean cold water.
- Latex paint – Fresh paint can be wiped off with a damp cloth. Hot soapy water will normally remove dried latex.
 - Tar, Asphalt – Remove immediately as prolonged contact will result in a permanent stain. Use a cloth lightly dampened with mineral spirits and rub the stain gently, working from the outer edge of the stain towards the center in order to prevent spreading. Rinse with soap and water.

The following are typical stains and cleaning tips for interior marine vinyl:

- Dry soil, dust and dirt, dried on dirt - Remove with a soft cloth. Wash with a soft cloth or nylon brush dampened with water.
- Variations in surface gloss - Wipe with a water dampened soft cloth and allow to air dry.
- Stubborn dirt - Wash with a soft cloth or soft nylon brush dampened with Ivory Soap® and water. Rinse with clean water.
- Stubborn spots and stains - Spray with Tan-nery Car Care Cleaner® and rub with a soft cloth. Rinse with clean water.
- Liquid spills - Wipe immediately with a clean absorbent cloth. Rinse with clean water.
- Food grease and oily stains - Spray immediately using either Fantastik Cleaner® or Tan-nery Car Care Cleaner®, wiping with a soft cloth. Take care not to extend the area of contamination beyond its original boundary. Rinse with clean water.

Additional Warnings for Vinyl Fabrics

- Detergents should not be used on a regular or repeated basis for normal cleaning.
- Powdered abrasives, cleaners containing abrasives, steel wool and industrial strength cleaners are not recommended for vinyl.
- Any lacquer solvent will cause immediate, irreparable damage to the vinyl.
- Wax should never be used on any vinyl upholstery, as it will cause premature embrittlement and cracking.
- Dilute chlorine bleach before using. Never use at full strength.
- If flammable solvents such as alcohol, turpentine or varsol are used for cleaning, then only small quantities should be employed in a well ventilated area. Exercise proper care by advising any personnel in the area and keep away from any ignition source. Always wear protective gloves.

Marine Interior Fabrics

Spot clean only with water based shampoo or foam upholstery cleaner. Pretest a small, inconspicuous area before proceeding. Do not over wet. Do not use solvents to spot clean. Pile fabrics may require brushing with a nonmetallic, stiff bristle brush to restore appearance.

NOTICE:

Water extraction or steam cleaning is not a recommended cleaning method. Cushion covers should not be removed and laundered.

To prevent overall soiling, frequent vacuuming or light brushing with a nonmetallic, stiff bristle brush to remove dust and grime is recommended. When cleaning a spill, blot immediately to remove spilled material. Clean spot or stains from the outside to the middle of the affected area to prevent circling.

Use a professional furniture cleaning service when an overall soiled condition has been reached.

Marine Exterior Vinyl Upholstery with PreFixx® Coating

Monterey Boats uses OMNOVA white, smoother and embossed pleated vinyl material with PreFixx top coating. All other accent embossed white and colored vinyl requires different care and maintenance.

PreFixx Cleaning Instructions

PreFixx is engineered so that upholstery can be cleaned again and again without showing signs of wear. With easy cleanability, proven stain and abrasion resistance, PreFixx protective finish can reduce maintenance costs and frequent reupholstery.

Durability

Creates a barrier that resists stains from penetrating to the surface of the vinyl for proven, long-lasting protection. With laboratory-tested stain resistance and improved wear properties, BoltaSoft® upholstery treated with PreFixx protective finish can retain a "like-new" appearance longer.

Easy Maintenance

Enables most common stains like dirt and smudges to wipe off easily. Many difficult stains like ballpoint ink also can be cleaned with active solvents, such as nail polish remover, without damaging the PreFixx protective finish (when recommended cleaning instructions are followed).

Normal Care and Cleaning

Remove ordinary dirt and smudges with a mild soap and water solution and a clean, soft cloth or towel. Dry with a soft, lint-free cloth or towel.



CAUTION



THE USE OF VINYL "CONDITIONERS" OR "PROTECTANTS" IS NOT RECOMMENDED AND SHOULD BE AVOIDED ON VINYL UPHOLSTERY TREATED WITH PREFIXX PROTECTIVE FINISH.

Special Cleaning Problems

Although BoltaSoft upholstery treated with Pre-Fixx protective finish is resistant to most common stains, the dyes and pigments in some staining agents have the ability to create a permanent stain if not treated properly. To clean difficult stains from upholstery treated with Pre-Fixx protective finish, locate the staining agent in lists below and follow its recommended cleaning method. For best results, treat all stains immediately.

Cleaning Tip: To determine the method and type of cleaners, the source of the stain should be identified.

Staining Agents: Baby oil, ketchup, chocolate, motor oil, olive oil, grape juice, urine, blood, hair oil tonic, tea, coffee and betadine. Use Method 1.

Staining Agents: Eye shadow, crayon and grease. Use Method 1. If stains remain, use Method 2.

Staining Agents: Tobacco tar (nicotine) permanent felt tip marker, yellow mustard, lipstick, ballpoint pen and spray paint. Use Method 1. If stains remain, use Method 2. For stubborn stains still remaining, use Method 3.

The recommended cleaners used in Cleaning Methods 1, 2 and 3 are progressively more aggressive. Often, it is better to begin with the least aggressive cleaner and move the next strongest only if the stain remains. NEVER EXCEED a staining agent's recommended cleaner or cleaning method, however.

Method 1

Use one of the following cleaners with a soft cloth or damp sponge. Rinse area with fresh water, and then dry with a clean, lint-free cloth.

- Formula 409® All-Purpose Spray Cleaner
- Fantastik® Spray Cleaner

Method 2

Use a solvent-type cleaner, such as rubbing alcohol (isopropyl alcohol). Rinse cleaned area with fresh water, and then dry with a clean, lint-free cloth.

Method 3

Use a strong, active solvent cleaner diluted in water (70% water/30% solvent cleaner), such as nail polish remover (acetone/water). Clean with a soft cloth or damp sponge. Stain should be removed with less than six (6) rubs. If the stain persists after six rubs, the stain has set and probably cannot be removed. Rinse cleaned area with fresh water, and then dry with a clean, lint-free cloth.



CAUTION



SOME SOLVENTS ARE HIGHLY FLAMMABLE. EXERCISE PROPER CARE IN CLEANING AND NOTIFY PERSONNEL IN AREA OF DANGER. WEAR RUBBER GLOVES DURING ALL CLEANING ACTIVITIES. USE CAUTION IN CLEANING AROUND BUTTONS, STITCHING AND WOODEN OR DECORATIVE TRIM, SINCE THESE SOLVENTS COULD SERIOUSLY DAMAGE SUCH AREAS.

CARPET STAIN REMOVAL INSTRUCTIONS

<p>Miscellaneous Stains</p> <p>Coffee, Tea, Coke, Dye, Fruit Juice, Ice Cream, Motor Oil, Clay, Grease, Blood, Catsup, Chocolate, Milk, Rust, Latex Paint, Water Colors, Berry Stains, Egg, Salad Dressing, Wine, Furniture Polish, Fish Formula, Mayonnaise or urine.</p>	<p>Removal Process</p> <p>Apply warm water and household detergent in minimal amounts to the stained area. Sponge or scrape until stain is removed and wash thoroughly with clean water.</p>
<p>Persistent Stains</p> <p>Chewing Gum, Crayon, Ink, Wax, Lipstick, Tar Polish or Oil Paint.</p>	<p>Removal Process</p> <p>Apply warm water and household detergent. Work well into the stained area, then flush with warm water.</p>

Exterior Carpet

Exterior carpet manufactured by Syntec® Industries is produced with a special blend of resilient fibers to withstand traffic and retain its beauty.

Carpets manufactured by Syntec are inherently stain-resistant. To keep your carpet at its best, we recommend regular vacuuming for general cleaning, soap and water for hard-to-remove spots and an approved cleaner for deep cleansing and to revitalize the carpet.

Stain Removal

If a spill does occur, it can easily be removed by following the stain removal chart. All stains should be removed as soon as possible, as this enhances the ability to remove the stain.

NOTICE:

Most stains should be removed easily from Olefin fibers. If the stain persists, the cleaning procedure should be repeated to ensure stain removal. Remember, the sooner the stain removal process begins, the easier the stain will be to remove. Under no circumstances should any solvent normally associated with the dry cleaning of apparel (perchloroethylene), carbon tetrachloride, etc.) be utilized, as permanent damage to the fiber will result.

Canvas and Side Curtains

Acrylic (Sunbrella) canvas should be rinsed frequently with clear, fresh water and cleaned periodically by using a mild soap and water. Scrub lightly and rinse thoroughly to remove the soap.

Do not use detergents. The water should be cold or luke warm, never hot. Scrub with a soft brush and rinse thoroughly. Allow to air dry.

The top or accessories should never be folded or stored wet.

After several years, the acrylic canvas may lose some of its ability to shed water. If this occurs, wash the fabric and treat it with a commercially available water proofing designed for this purpose. Monterey recommends 303 High Tech Fabric Guard.

To apply waterproofing, wash the canvas and allow it to dry completely. Then apply a thin, even coat of waterproofing, allowing the first coat to air dry. Apply a second coat for increased protection.

NOTICE:

Some leakage at the seams is normal and unavoidable with acrylic enclosures.

NOTICE:

Some boats are equipped with acrylic (Sunbrella) canvas that is coated with a permanent water proofing called Sea Mark. Canvas treated with Sea Mark will not lose its ability to shed water and never needs to be retreated.

Side curtains and clear connectors can be cleaned with mild soap and water. They should not be allowed to become badly soiled. Dirt, oil, mildew, and cleaning agents containing ammonia, will shorten the life of the vinyl that is used for clear

curtains. After cleaning the curtains and allowing them to dry, apply a non-lemon furniture polish or an acrylic glass and clear plastic protector to extend the life of the curtains.

Vinyl curtains should be stored either rolled or flat, without folds or creases. Folding the curtains will make permanent creases that could cause the vinyl to crack.

NOTICE:



Do not use any polish containing lemon scents or lemon. The lemon juice will attack the vinyl and shorten its life.



Snaps should be lubricated periodically with Teflon or silicone grease. Zippers should be lubricated with silicone spray, paraffin or a product designed to lubricate zippers in marine canvas.



The bimini top, side curtains, clear connector, back drop and aft curtain must be removed when trailering. Canvas enclosures are not designed to withstand the extreme wind pressure encountered while trailering and will be damaged. Always remove and properly store the enclosure before trailering your boat.

NOTICE:

Your Monterey boat is basically an open vehicle. Therefore, in spite of well-designed and well-fitting canvas enclosures, your boat is not waterproof. We have made every effort to design these enclosures to conform with the boat, but a certain amount of leakage may occur, especially at the seam lines. After cleaning with soap and water, allow seams to thoroughly dry. A sealant can be applied on the seams to somewhat close the needle holes according to the manufacturer's instructions.

	WARNING	
DO NOT OPERATE THE ENGINE, FUEL CONSUMING HEATERS OR BURNERS WITH THE CANVAS ENCLOSURES CLOSED. THE COCKPIT MUST BE OPEN FOR LEGAL VENTILATION AND TO PREVENT THE POSSIBLE ACCUMULATION OF CARBON MONOXIDE FUMES, WHICH COULD BE LETHAL.		

	WARNING	
CARBON MONOXIDE IS A LETHAL, TOXIC GAS THAT IS COLORLESS AND ODORLESS. IT IS A DANGEROUS GAS THAT WILL CAUSE DEATH IN CERTAIN LEVELS.		

	CAUTION	
NEVER TRAILER YOUR BOAT WITH THE CANVAS ENCLOSURE (INCLUDING SIDE CURTAINS, AFT CURTAIN, WINDSHIELD CONNECTOR, BOW COVER AND COCKPIT COVER) UP. MONTEREY BOATS' CANVAS IS NOT DESIGNED TO WITHSTAND THE HIGH WIND LOADS OF TRAILERING. SEVERE WIND DAMAGE CAN OCCUR SUCH AS TORN MATERIAL, FASTENER PULL-OUT AND FRAME DISTORTION. DAMAGE CAUSED BY TRAILERING IS NOT COVERED UNDER THE LIMITED WARRANTY.		

13.3 Cabin Interior

The cabin interior can be cleaned just like you would clean a home interior. The wood floors and steps can be vacuumed and cleaned with a mixture of water and Murphy's Oil Soap or white vinegar and water. Wipe the wood dry with a clean towel. To preserve the cherry and teak woodwork, use furniture polish with wax. To maintain the carpeting, use a vacuum cleaner.

Because air and sunlight are very good cleansers, periodically put cushions, sleeping bags, etc. on deck, in the sun and fresh air to dry and air out. If cushions or equipment get wet with saltwater, remove and use clean, fresh water to rinse off the salt crystals. Salt retains moisture and will cause damage. Dry thoroughly and reinstall.

Vinyl headliner material should be cleaned periodically as explained in the previous section. Avoid using products containing ammonia, bleach, or harsh chemicals as they can shorten the life of vinyl.

If you leave the boat for a long period of time, put all cushions on their sides, open all interior cabin and locker doors, and hang a commercially available mildew protector in the cabin.

	CAUTION	
ALWAYS READ THE LABEL CAREFULLY ON MILDEW PROTECTORS. REMOVE THE PROTECTOR AND ALLOW THE CABIN TO VENTILATE COMPLETELY BEFORE USING THE CABIN.		

Karadon Surfaces

A mild liquid detergent and water or ammonia-based cleaners will remove most dirt and stains from Karadon. For heavy cleaning, oil, and grease, use Fantastik® spray cleaner. Rinse with a clean cloth moistened with fresh water. Wipe dry with a clean cloth.

In most cases, Karadon can be repaired if accidentally damaged. Minor damage, including scratches, general or chemical stains, scorching or burns, and minor impact marks, can be repaired with a light abrasive cleanser and a Scotch-Brite® pad. For heavier damage, light sanding and machine buffing may be necessary so contact your dealer or a professional.

- Avoid exposing Karadon to strong chemicals, such as paint removers, oven cleaners, etc. If contact occurs, quickly flush the surface with water.
- Remove nail polish with a non acetone-based polish remover and flush with water.
- Do not cut directly on Karadon counter tops.

13.4 Bilge and Engine Compartment

To keep the bilge clean and fresh, use a commercial bilge cleaner regularly. Follow the directions carefully. The engine and engine compartment should be kept clean and free of oil accumulation and debris. All exposed pumps and metal components, including the engine and drive gear, should be sprayed periodically with a protector to reduce the corrosive effects of the high humidity always present in these areas.

Maintenance intervals are outlined in the engine owner's manuals. Their recommendations should be followed exactly.

Periodically check the bilge pump for proper operation and clean debris from the strainers and float switch. Inspect all hoses, clamps and thru-hulls for leaks and tightness on a regular basis and operate all thru-hull valves at least once a month to keep them operating properly.

A flow of air into the bilge is provided by vents located in the deck near the engine compartment. Periodic inspection and cleaning of the ventilation ducts is necessary to ensure adequate air circulation.

Engines

Proper engine maintenance is essential to the proper performance and reliability of your inboard engines. Maintenance schedules and procedures are outlined in your engine owner's manual. They should be followed exactly.

Proper engine operation requires a good supply of clean, dry fuel. Improper marina fuel storage techniques, limited boat usage, etc. can cause the fuel to become contaminated.

The age of fuel can affect engine performance. Chemical changes occur as the fuel ages that can cause deposits and reduce the cetane or octane rating of the fuel. Severely degraded fuel can damage the engine and boat fuel tank and lines. Therefore, if your boat is not being run enough to require at least one full tank of fresh fuel a month, a fuel additive should be added to protect it from degradation. Your dealer or the engine manufacturer can provide additional information on fuel degradation and fuel stabilizers recommended for your engine.

In many states, most gasoline is blended with ethanol alcohol. Ethanol is a strong solvent and can absorb water during periods of storage. You should refer to the engine operating manual for information regarding alcohol blended fuels and how it affects the operation of your marine engine.

Generator (Optional 328SS)

The engine maintenance required on the generator is similar in many ways to the main engines. The engine incorporates a pressure-type lubrication system and a fresh water cooled engine block which is thermostatically controlled.

The seawater cooling system on the generator is equipped with a sacrificial anode to protect cooling system components from galvanic corrosion. The anode should be inspected when the generator is serviced and replaced when it is 75% of its original size or at least once each year.

The most important factors to the generator's longevity are proper ventilation and maintenance of the fuel system, ignition system, cooling system, lubrication system and the AC alternator.

Maintenance schedules and procedures are outlined in your generator owner's manual. They should be followed exactly.

NOTICE:

The generator charges the house batteries just enough to compensate for the DC electrical current the engine requires to operate. Therefore, it is important to activate the battery charger to maintain the house and engine batteries whenever the generator is running.

- Flush all gravity drains with fresh water to keep them clean and free flowing.
- Operate the thru-hull valves once a month and service as required.



NOTICE:

All drains and pumps must be properly winterized before winter lay-up.

13.5 Drainage System

It is essential that the following items be done periodically to maintain proper drainage of your boat:

- Clean the cockpit drains with a hose to remove debris that can block water drainage.
- Frequently test the automatic bilge pump switches for proper operation. This is accomplished by lifting the float switch until the pump is activated. You can also use a garden hose to flood the bilge until the water level is high enough to activate the pump.

	CAUTION	
NEVER USE HARSH CHEMICAL DRAIN CLEANERS IN MARINE DRAIN SYSTEMS. PERMANENT DAMAGE TO THE HOSES AND FITTINGS MAY RESULT.		

THIS PAGE WAS LEFT BLANK
INTENTIONALLY

SEASONAL MAINTENANCE

14.1 Lay-up and Storage

Before Hauling:

- Pump out the head and holding tank. Flush the holding tank using clean water and a deodorizer. Pump out the cleaning solution.
 - The fuel tank should be left nearly full to reduce condensation that can accumulate in the tank. Allow enough room in the tank for the fuel to expand without leaking out the vent.
 - The age of fuel can affect engine performance. Chemical changes occur as the fuel ages that can cause deposits and reduce the octane rating of the fuel. Severely degraded fuel can damage the engine and boat fuel tank and lines. Therefore, if your boat is not being run enough to require at least one full tank of fresh fuel a month, a fuel additive should be added to protect it from degradation. Operate the boat for at least 15 minutes after adding the additive to allow the treated fuel to reach the engine.
- Your dealer or the engine manufacturer can provide additional information on fuel degradation and fuel additives recommended for your engine. For more recommendations for your specific area, check with your dealer.
 - Drain water from the fresh water system.
 - Drain the water from the ballast tank. Make sure to monitor the tank as it pumps out and turn the pump off immediately when pumping is complete. Remember that the pump will be damaged if it is allowed to run dry for more than a 15 or 20 seconds.
 - Consult the engine owner's manual for detailed information on preparing the engine for storage.

Lifting

It is essential that care be used when lifting your boat. Make sure the spreader bar at each sling is at least as long as the distance across the widest point of the boat that the sling will surround. Put the slings in position. The fore and aft slings should be tied together to prevent the slings from sliding on the hull.



Typical Sling Locations



CAUTION



BOATS CAN BE DAMAGED FROM IMPROPER LIFTING AND TRANSPORTING WITH FORKLIFTS. CARE AND CAUTION MUST BE EXERCISED WHEN TRANSPORTING A BOAT WITH A FORK LIFT. NEVER HOIST THE BOAT WITH A SUBSTANTIAL AMOUNT OF WATER IN THE BILGE.

SEVERE GEL COAT CRACKING OR MORE SERIOUS HULL DAMAGE CAN OCCUR DURING HAULING AND LAUNCHING IF PRESSURE IS CREATED ON THE GUNWALES (SHEER) BY THE SLINGS. FLAT, WIDE BELTING SLINGS AND SPREADERS LONG ENOUGH TO KEEP PRESSURE FROM THE GUNWALES ARE ESSENTIAL. DO NOT ALLOW ANYONE TO HAUL YOUR BOAT WHEN THE SPREADERS ON THE LIFT ARE NOT WIDE ENOUGH TO TAKE THE PRESSURE OFF THE GUNWALES.

Supporting The Boat For Storage

A trailer, elevating lift, or a well-made cradle is the best support for your boat during storage.

When storing the boat on a trailer for a long period:

- Make sure the trailer is on a level surface and the bow is high enough so that water will drain from the bilge and cockpit.
- Make sure the outdrive is in the down position.
- The trailer must properly support the hull. The bunks and rollers should match the bottom of the hull and should not be putting pressure on the lifting strakes.
- Make sure the hitch is properly supported.
- Check the tires once each season. Add enough air for the correct amount of inflation for the tires.

NOTICE:

Read the owner's manual for the trailer for the correct amount of inflation for the tires.

When storing the boat on a lift or cradle:

- The cradle must be specifically for boat storage.
- Make sure the cradle or lift is well supported with the bow high enough to provide proper drainage of the bilge.
- Make sure the outdrive is in the down position.

- The cradle or lift must be in the proper fore and aft position to properly support the hull. When the cradle or lift is in the correct location, the bunks should match the bottom of hull and should not be putting pressure on the lifting strakes.



CAUTION



BOATS HAVE BEEN DAMAGED BY TRAILERS, LIFTS, AND CRADLES THAT DON'T PROPERLY SUPPORT THE HULL. ALWAYS MAKE SURE THE BUNKS AND ROLLERS ARE ADJUSTED SO THEY ARE NOT PUTTING PRESSURE ON THE LIFTING STRAKES AND ARE PROVIDING ENOUGH SUPPORT FOR THE HULL. HULL DAMAGE RESULTING FROM IMPROPER CRADLE OR TRAILER SUPPORT IS NOT COVERED BY THE MONTEREY WARRANTY.

Preparing The Boat For Storage:

- Remove the bilge drain plug, if installed.
- Thoroughly wash the fiberglass exterior, especially the antifouling portion of the bottom. Remove as much marine growth as possible. Lightly wax the exterior fiberglass components.
- Remove all oxidation from the exterior hardware, and apply a light film of moisture displacing lubricant, wax or a metal protector.
- Remove propellers and grease the propeller shafts using light waterproof grease.
- Remove the batteries and store in a cool place. Clean using clear, clean water. Be sure the batteries have sufficient water and clean terminals. Keep the batteries charged and safe from freezing throughout the storage period.

NOTICE:

Refer to the Electrical System chapter, for information on the maintenance of the AC and DC electrical systems.

- Coat all faucets and exposed electrical components in the cabin and cockpit with a protecting oil.
- Clean out, totally drain and completely dry the storage compartments and sinks.
- Thoroughly clean the interior of the boat. Vacuum all carpets and dry clean drapes and upholstery.

- Remove cushions, open as many locker doors as possible. Leaving as many of these areas open as possible will improve the boat's ventilation during the storage period.

NOTICE:

It is recommended that a mildew preventer be hung in the head compartment or cabin before it is closed for storage.

- Clean the exterior upholstery with a good vinyl cleaner and dry thoroughly. Spray the weather covers and boat upholstery with a spray disinfectant. Enclosed areas such as the in-floor compartments, storage locker areas, etc. should also be sprayed with this disinfectant.

14.2 Winterizing

Fresh Water System

The entire fresh water system must be completely drained. Disconnect all hoses, check valves, etc. and blow all the water from the system. Make sure the water heater and fresh water tank are completely drained. Use only very low air pressure when doing this to prevent possible system damage. Because of the check valve mechanism built in the pump, blowing the lines will not remove the water from the fresh water pump. Remove the inlet and outlet hoses on the pump. Turn the pump on and allow it to pump out any remaining water (about a cupful).

A recommended alternative to the above-mentioned procedure is the use of commercially available non toxic, fresh water system antifreeze. After draining the potable water tank, lines and water heater, pour the antifreeze mixture into the fresh water tank, prime and operate the pump until the mixture flows from all fresh water faucets. Be sure to open all hot and cold water faucets, including the fresh water shower in the cockpit and the faucet in the wet bar. Make sure antifreeze has flowed through all of the fresh water drains and the ice maker supply line.

The shower drain water sump system must be properly winterized. Clean debris from the drain and sump and flush for several minutes with fresh clean water. After the system is clean, pump the drain sumps as dry as possible. Then pour a potable water antifreeze mixture into the shower drain until antifreeze has been pumped through the entire system and out of the thru-hull. Follow the same procedure for the optional grey

water sump system. Pour the antifreeze for the grey water sump into the cabin sink drains until antifreeze has been pumped through the entire system and out of the thru-hull.

For additional information refer to the Fresh Water System chapter. Also, refer to the ice maker owner's manual for information on winterizing the ice maker.

Engine and Optional Generator Raw Water Systems

Drain all of the sea strainers, heat exchangers and raw water supply and discharge lines for the engine and generator raw water supply pumps. Make sure all seawater has drained from the exhaust system. Some, but not all, engine mufflers could have a drain plug that must be removed to properly drain the muffler. Once this is accomplished, pour a non toxic marine engine antifreeze mixture into a large pail and put the engine raw water intake lines into the solution. Run each engine one at a time until the antifreeze solution is visible at the transom exhaust port or the propeller exhaust hub, then shut the engine off.

NOTICE:

Properly winterize the engines and fuel system by following the engine manufacturer's winterizing procedures located in your engine owner's manuals or contact a Monterey dealer.

Refer to the Raw Water System chapter for additional information on the raw water system.

Portable Head

The portable head must be properly winterized by following the manufacturer's winterizing instructions in the portable head owner's manual.

Marine Toilet

The marine toilet must be properly winterized by following the manufacturer's winterizing instructions in the marine toilet owner's manual. The fresh water supply will be winterized with the fresh water system. Drain the discharge hoses completely turning off the fresh water supply so the bowl stays dry and flushing the toilet several times. The head holding tank and macerator discharge pump must be pumped dry and three gallons of potable water antifreeze poured into the tank through the deck waste pump out fitting. After the antifreeze has been added to the holding tank, open the overboard discharge valve and activate the macerator pump (if your boat is

equipped with the optional overboard discharge system) until the antifreeze solution is visible at the discharge thru-hull.

NOTICE:

Make sure you follow the marine toilet manufacturer's winterizing instructions exactly.

Grey Water System

The drain sump system must be properly winterized. Clean debris from the drain and sump. After the system is clean, pump the drain sump as dry as possible. Then pour a potable water antifreeze mixture into each sink drain until antifreeze has been pumped through the entire system and into the waste tank.

Air Conditioner

Disconnect and drain the seawater pump intake and discharge hoses. Remove all water from the sea strainer and thru-hull fitting. Allow all water to drain from the system. The air conditioner components must be properly winterized by following winterizing procedure in the manufacturer's owner's manual.

The drain sump system must be properly winterized. Clean debris from the drain and sump and flush for several minutes with fresh clean water. After the system is clean, pump the drain sump as dry as possible. Then pour a potable water antifreeze mixture into the air conditioning drain pan until antifreeze has been pumped through the entire system and out of the thru-hull. The air conditioning system and fresh water shower share the same sump system.

NOTICE:

The air conditioning, engine control system, head, and steering systems have specific lay up requirements. Please refer to their owner's manuals for recommended winterizing procedures.

Bilge

Coat all metal components, wire busses, and connector plugs in the bilge with a protecting oil. It is also important to protect all strainers, sea cocks and steering components. The bilge pump and bilge pump lines must be completely free

of water and dried out when the boat is laid up for the winter in climates where freezing occurs. Compartments in the bilge that will not drain completely should be pumped out and then sponged until completely free of water. Dry the hull bilge and self-bailing cockpit troughs. Water freezing in these areas could cause damage.

Arch



It is imperative that all drain holes in the legs are open and that the legs are completely free of water. Remove the canvas and thoroughly clean and store in a safe, dry place. Coat all wire connectors and bus bars in the helm compartment with a protecting oil.

Clean the aluminum frame with soap and water and dry thoroughly. Apply an aluminum metal protector to the entire frame on anodized aluminum to reduce corrosion and pitting. Powder Coated and painted aluminum should be waxed.

Special Notes Prior To Winter Storage

If the boat will be in outside storage, properly support a storage cover and secure it over the boat. It is best to have a frame built over the boat to support the canvas. It should be a few inches wider than the boat so the canvas will clear the rails and allow passage of air. If this cover is fastened too tightly there will be inadequate ventilation and this can lead to mildew, moisture accumulation, etc. It is essential to fasten the canvas down securely so that the wind cannot remove it or cause chafing of the hull superstructure. Do not store the boat in a damp storage enclosure. Excessive dampness can cause electrical problems, corrosion, and excessive mildew.

Whenever possible, do not use the enclosure curtains in place of the winter storage cover. The life of these curtains may be significantly shortened if exposed to harsh weather elements for long periods.

 **CAUTION** 



PLACING AN ELECTRIC OR FUEL BURNING HEATING UNIT IN THE BILGE AREA CAN BE POTENTIALLY HAZARDOUS AND IS NOT RECOMMENDED.

Proper storage is very important to prevent serious damage to the boat. If the boat is to be stored indoors, make sure the building has enough ventilation. It is very important that there is enough ventilation both inside the boat and around the boat.

NOTICE:



If the boat is to be stored indoors or outdoors, open all drawers, clothes lockers, cabinets, and doors a little. If possible, remove the upholstery, mattresses, clothing, and carpets. Then hang a commercially available mildew protector in the cabin.

14.3 Recommissioning

	WARNING	
<p>DO NOT OPERATE THE BOAT UNLESS IT IS COMPLETELY ASSEMBLED. KEEP ALL FASTENERS TIGHT. KEEP ADJUSTMENTS ACCORDING TO SPECIFICATIONS.</p>		

NOTICE:

It is important and recommended that the fitting out procedure for the marine gear be done by a qualified marine technician. Read the engine owner's manual for the recommended procedure.

	WARNING	
<p>IF YOUR BOAT IS EQUIPPED WITH GENERATOR MAKE SURE THE MUFFLER HAS NOT BEEN DAMAGED DURING WINTER STORAGE AND THAT THE DRAIN PLUGS ARE INSTALLED AND PROPERLY TIGHTENED. LOOSE OR MISSING DRAIN PLUGS AND DAMAGED OR LEAKING MUFFLERS OR EXHAUST HOSES WILL ALLOW CARBON MONOXIDE, ENGINE GASES, AND WATER INTO THE BILGE CREATING A POTENTIALLY HAZARDOUS CONDITION.</p>		

NOTICE:

Not all mufflers are equipped with drain plugs.

Reactivating The Boat After Storage:

- If your boat is bottom painted, apply a fresh coat of bottom paint on the hull and outdrive
- Inspect outdrive and thru-hull fittings.

- Install the propellers. Refer to the outdrive owner's manual for information on installing propellers.
- Install the drain plug in the hull.
- Charge and install the batteries.
- Check the engines for damage and follow the manufacturer's instructions for recommissioning.
- Check the engine mounting bolts to make sure they are tight.
- Perform all routine maintenance.
- Check all hose clamps for tightness.
- Pump the antifreeze from the fresh and raw water systems and flush several times with fresh water. Make sure all antifreeze is flushed from the water heater and it is filled with fresh water before it is activated.
- Check and lubricate the steering system.
- Clean and wash the boat.
- Install all upholstery, cushions and canvas.
- Check the fluid levels in the engine and outdrive.

After Launching:

- Carefully check the engine and all water systems for leaks. Operate each system one at a time checking for leaks and proper operation.
- Check the bilge pump automatic and manual switch.
- Prime the fuel system and start the engine.
- Carefully monitor the gauges and check for leakage and abnormal noises. Monitor the temperature gauge closely until it stabilizes at normal operating temperature to ensure that the cooling pump is operating properly.
- Operate the boat at slow speeds until the engine temperature stabilizes and all systems are operating normally.

Generator Commissioning:

- Start the generator and monitor the exhaust port for a steady stream of water. It may take 20 or 30 seconds for the muffler to fill and for water to appear at the port. This ensures that the cooling pump is operating. Carefully inspect the generator and all hoses for leaks, paying particular attention to the muffler and exhaust hoses. Any leak, no matter how minor must be corrected immediately.
- Once the generator is started and operating normally, activate the air conditioners and monitor the outlet port for a steady stream of water. It may take 20 or 30 seconds for the sea strainer and system to fill and for water to appear at the port. This ensures that the cooling pump is properly primed and operating. Carefully inspect all hoses for leaks, paying particular attention to the hoses below the waterline and those connected to the air conditioning system.
- If the pump runs but no water is visible at the outlet port after 45 seconds the air conditioning cooling pump may be air locked. The intake for the raw water manifold is equipped with a scoop and ball valve. Make sure the valve is open and run the boat at or above 15 M.P.H. for several minutes. The water pressure from the scoop will force the trapped air through the pump and allow it to prime. If this procedure doesn't work, contact your Monterey dealer.

Float Plan

Monterey Boats recommends filling out a float plan each time you use your boat for an offshore day trip or a long cruise. Leave this information with a responsible person ashore, like a close friend or relative that you know well.

1. Name of person reporting and telephone number.

2. Description of boat.

Type _____ Color _____ Trim _____

Registration No. _____ Length _____

Name _____ Make _____ Other Info _____

3. Engine type _____ H.P. _____

No. of Engines _____ Fuel Capacity _____

4. Survival equipment: (Check as appropriate)

<input type="checkbox"/> PFDS	<input type="checkbox"/> Flares	<input type="checkbox"/> Mirror
<input type="checkbox"/> Smoke Signals	<input type="checkbox"/> Flashlight	<input type="checkbox"/> Food
<input type="checkbox"/> Paddles	<input type="checkbox"/> Water	<input type="checkbox"/> Others
<input type="checkbox"/> Anchor	<input type="checkbox"/> Raft or Dinghy	<input type="checkbox"/> EPIRB

5. Radio Yes No Type _____

6. Automobile license _____

Type _____ Trailer License _____

Color _____ and make of auto _____

7. Persons aboard _____

Name _____ Age _____ Address & telephone No. _____

8. Do any of the persons aboard have a medical problem?

Yes No If yes, what? _____

9. Trip Expectations: Leave at _____

From _____ Going to _____

Expect to return by _____ (time)

and no later than _____

10. Any other pertinent info. _____

11. If not returned by _____ (time)

call the COAST GUARD, or (Local authority) _____

12. Telephone Numbers.

THIS PAGE WAS LEFT BLANK
INTENTIONALLY

Boating Accident Report

DEPARTMENT OF TRANSPORTATION U.S. COAST GUARD CG-3865 (Rev. 9/95)		BOATING ACCIDENT REPORT		FORM APPROVED OMB NO. 2115-0010	
STATE ASSIGNED CASE NO. _____					
THE OPERATOR/OWNER OF A VESSEL USED FOR RECREATIONAL PURPOSES IS REQUIRED TO FILE A REPORT IN WRITING WHENEVER AN ACCIDENT RESULTS IN: LOSS OF LIFE OR DISAPPEARANCE FROM A VESSEL; AN INJURY WHICH REQUIRES MEDICAL TREATMENT BEYOND FIRST AID; OR PROPERTY DAMAGE IN EXCESS OF \$2000 OR COMPLETE LOSS OF THE VESSEL. REPORTS IN DEATH AND INJURY CASES MUST BE SUBMITTED WITHIN 48 HOURS. REPORTS IN OTHER CASES MUST BE SUBMITTED WITHIN 10 DAYS. REPORTS MUST BE SUBMITTED TO THE REPORTING AUTHORITY IN THE STATE WHERE THE ACCIDENT OCCURRED. THIS FORM IS PROVIDED TO ASSIST THE OPERATOR IN FILING THE REQUIRED WRITTEN REPORT.					
COMPLETE ALL BLOCKS (INDICATE THOSE NOT APPLICABLE BY "NA")					
ACCIDENT DATA					
DATE OF ACCIDENT	TIME	AM PM	NAME OF BODY OF WATER	LOCATION (GIVE LOCATION PRECISELY)	
NUMBER OF VESSELS INVOLVED	NEAREST CITY OR TOWN		COUNTY	STATE	ZIP CODE
WEATHER (CHECK ALL APPLICABLE) [] CLEAR [] RAIN [] CLOUDY [] SNOW [] FOG [] HAZY	WATER CONDITIONS [] CALM (WAVES LESS THAN 6") [] CHOPPY (WAVES 6" TO 2') [] ROUGH (WAVES 2' TO 6") [] VERY ROUGH (GREATER THAN 6") [] STRONG CURRENT		TEMPERATURE (ESTIMATE) AIR _____ °F WATER _____ °F	WIND [] NONE [] LIGHT (0-6 MPH) [] MODERATE (7-14 MPH) [] STRONG (15-25 MPH) [] STORM (OVER 25 MPH)	VISIBILITY DAY NIGHT [] GOOD [] [] FAIR [] [] POOR []
NAME OF OPERATOR			OPERATOR ADDRESS		
OPERATOR TELEPHONE NUMBER ()	DATE OF BIRTH MO DAY YR	OPERATOR'S EXPERIENCE [] NONE [] UNDER 100 HOURS [] > 100 HOURS		INSTRUCTION IN BOATING SAFETY [] STATE COURSE [] U.S. POWER SQUADRON [] USCG AUXILIARY [] AMERICAN RED CROSS [] NONE	
[] MALE [] FEMALE					
NAME OF OWNER			OWNER ADDRESS		
OWNER TELEPHONE NUMBER ()	NUMBER OF PEOPLE ON BOARD	NUMBER OF PEOPLE BEING TOWED	RENTED BOAT? [] YES [] NO		
BOAT NO. 1 (THIS VESSEL)					
BOAT REGISTRATION OR DOCUMENTATION NUMBER		STATE	HULL IDENTIFICATION NUMBER	BOAT NAME	
BOAT MANUFACTURER		LENGTH	MODEL	YEAR BUILT	
TYPE OF BOAT [] OPEN MOTORBOAT [] CABIN MOTORBOAT [] AUXILIARY SAIL [] SAIL (ONLY) [] ROWBOAT [] CANOE/KAYAK [] PERSONAL WATERCRAFT [] PONTOON BOAT [] HOUSEBOAT [] OTHER (SPECIFY)	HULL MATERIAL [] WOOD [] ALUMINUM [] STEEL [] FIBERGLASS [] RUBBER/VINYL/CANVAS [] RIGID HULL INFLATABLE [] OTHER (SPECIFY)	ENGINE [] OUTBOARD [] INBOARD [] INBOARD-STERNDRIVE (I/O) [] AIRBOAT	PROPULSION [] PROPELLER [] WATER JET [] AIR THRUST [] MANUAL [] SAIL	PERSONAL FLOTATION DEVICES (PFDS): WAS BOAT ADEQUATELY EQUIPPED WITH COAST GUARD APPROVED PFDS? [] YES [] NO WERE PFDS ACCESSIBLE? [] YES [] NO	
		FUEL [] GASOLINE [] DIESEL [] ELECTRIC	NUMBER OF ENGINES TOTAL HORSEPOWER	FIRE EXTINGUISHERS ON BOARD? [] YES [] NO USED? [] YES [] NO	
WHAT CONTRIBUTED TO ACCIDENT? (CHECK ALL APPLICABLE)					
OPERATION AT TIME OF ACCIDENT (CHECK ALL APPLICABLE) [] CRUISING [] CHANGING DIRECTION [] CHANGING SPEED [] DRIFTING [] TOWING [] BEING TOWED [] ROWING/PADDLING [] SAILING [] LAUNCHING [] DOCKING/UNDocking [] AT ANCHOR [] TIED TO DOCK/MOORED [] OTHER (SPECIFY)	ACTIVITY AT TIME OF ACCIDENT (CHECK ANY IF APPLICABLE) [] FISHING [] TOURNAMENT [] HUNTING [] SWIMMING/DIVING [] MAKING REPAIRS [] WATERSKIING/TUBING/ETC. [] RACING [] WHITEWATER SPORTS [] FUELING [] STARTING ENGINE [] NON-RECREATIONAL [] OTHER (SPECIFY)	TYPE OF ACCIDENT [] GROUNDING [] CAPSIZING [] FLOODING/SWAMPING [] SINKING [] FIRE OR EXPLOSION (FUEL) [] FIRE OR EXPLOSION (OTHER) [] SKIER MISHAP [] COLLISION WITH VESSEL [] COLLISION WITH FIXED OBJECT [] COLLISION WITH FLOATING OBJ. [] FALLS OVERBOARD [] FALLS IN BOAT [] STRUCK BY BOAT [] STRUCK BY MOTOR/PROPELLER [] STRUCK SUBMERGED OBJECT [] OTHER (SPECIFY)		[] WEATHER [] EXCESSIVE SPEED [] IMPROPER LOOKOUT [] RESTRICTED VISION [] OVERLOADING [] IMPROPER LOADING [] HAZARDOUS WATERS [] ALCOHOL USE [] DRUG USE [] HULL FAILURE [] MACHINERY FAILURE [] EQUIPMENT FAILURE [] OPERATOR INEXPERIENCE [] OPERATOR INATTENTION [] CONGESTED WATERS [] PASSENGER/SKIER BEHAVIOR [] DAM/LOCK [] OTHER (SPECIFY)	
ESTIMATED SPEED [] NONE [] UNDER 10 MPH [] 10 - 20 MPH [] 21 - 40 MPH [] OVER 40 MPH			[] HIT AND RUN		

Boating Accident Report

**MONTEREY
BOATS**

DECEASED (IF MORE THAN 2 FATALITIES, ATTACH ADDITIONAL FORMS)			
NAME OF VICTIM		ADDRESS OF VICTIM	
DATE OF BIRTH		DEATH CAUSED BY	
<input type="checkbox"/> MALE	<input type="checkbox"/> FEMALE	<input type="checkbox"/> DROWNING	<input type="checkbox"/> OTHER
		<input type="checkbox"/> DISAPPEARANCE	
NAME OF VICTIM		ADDRESS OF VICTIM	
DATE OF BIRTH		DEATH CAUSED BY	
<input type="checkbox"/> MALE	<input type="checkbox"/> FEMALE	<input type="checkbox"/> DROWNING	<input type="checkbox"/> OTHER
		<input type="checkbox"/> DISAPPEARANCE	
INJURED (IF MORE THAN 2 INJURIES, ATTACH ADDITIONAL FORMS)			
NAME OF VICTIM		ADDRESS OF VICTIM	
DATE OF BIRTH	MEDICAL TREATMENT BEYOND FIRST AID? ADMITTED TO HOSPITAL?	<input type="checkbox"/> YES <input type="checkbox"/> NO	DESCRIBE INJURY
		<input type="checkbox"/> YES <input type="checkbox"/> NO	
WAS PFD WORN?		PRIOR TO ACCIDENT?	
<input type="checkbox"/> YES	<input type="checkbox"/> NO	<input type="checkbox"/> YES	<input type="checkbox"/> NO
WAS IT INFLATABLE?		AS A RESULT OF ACCIDENT?	
<input type="checkbox"/> YES	<input type="checkbox"/> NO	<input type="checkbox"/> YES	<input type="checkbox"/> NO
NAME OF VICTIM		ADDRESS OF VICTIM	
DATE OF BIRTH	MEDICAL TREATMENT BEYOND FIRST AID? ADMITTED TO HOSPITAL?	<input type="checkbox"/> YES <input type="checkbox"/> NO	DESCRIBE INJURY
		<input type="checkbox"/> YES <input type="checkbox"/> NO	
WAS PFD WORN?		PRIOR TO ACCIDENT?	
<input type="checkbox"/> YES	<input type="checkbox"/> NO	<input type="checkbox"/> YES	<input type="checkbox"/> NO
WAS IT INFLATABLE?		AS A RESULT OF ACCIDENT?	
<input type="checkbox"/> YES	<input type="checkbox"/> NO	<input type="checkbox"/> YES	<input type="checkbox"/> NO
OTHER PEOPLE ABOARD THIS BOAT (IF MORE THAN 2 PEOPLE, ATTACH ADDITIONAL FORMS)			
NAME		ADDRESS	
DATE OF BIRTH	WAS PFD WORN? AS A RESULT OF ACCIDENT	<input type="checkbox"/> YES <input type="checkbox"/> NO	PRIOR TO ACCIDENT?
		<input type="checkbox"/> YES <input type="checkbox"/> NO	WAS IT INFLATABLE?
		<input type="checkbox"/> YES <input type="checkbox"/> NO	<input type="checkbox"/> YES <input type="checkbox"/> NO
NAME		ADDRESS	
DATE OF BIRTH	WAS PFD WORN? AS A RESULT OF ACCIDENT	<input type="checkbox"/> YES <input type="checkbox"/> NO	PRIOR TO ACCIDENT?
		<input type="checkbox"/> YES <input type="checkbox"/> NO	WAS IT INFLATABLE?
		<input type="checkbox"/> YES <input type="checkbox"/> NO	<input type="checkbox"/> YES <input type="checkbox"/> NO
BOAT NO. 2 (IF MORE THAN 2 VESSELS, ATTACH ADDITIONAL IDENTIFYING INFORMATION)			
NAME OF OPERATOR		OPERATOR ADDRESS	
OPERATOR TELEPHONE NUMBER ()		BOAT REGISTRATION OR DOCUMENTATION NUMBER STATE	
NAME OF OWNER		OWNER ADDRESS	
OWNER TELEPHONE NUMBER ()			
PROPERTY DAMAGE			
ESTIMATED AMOUNT: THIS BOAT AND CONTENTS:		OTHER BOAT(S) AND CONTENTS:	
\$		\$	
DESCRIBE PROPERTY DAMAGED		OTHER PROPERTY:	
		\$	
WITNESSES NOT ON THIS VESSEL			
NAME	ADDRESS	TELEPHONE NUMBER ()	
NAME	ADDRESS	TELEPHONE NUMBER ()	
PERSON COMPLETING REPORT			
NAME	ADDRESS	TELEPHONE NUMBER ()	
SIGNATURE	QUALIFICATION	<input type="checkbox"/> OPERATOR <input type="checkbox"/> OWNER	DATE SUBMITTED
		<input type="checkbox"/> INVESTIGATOR <input type="checkbox"/> OTHER	
FOR AGENCY USE ONLY			
CAUSES BASED ON (CHECK ONE): <input type="checkbox"/> THIS REPORT <input type="checkbox"/> INVESTIGATION <input type="checkbox"/> INVESTIGATION AND THIS REPORT <input type="checkbox"/> OTHER			
NAME OF REVIEWING OFFICE	DATE RECEIVED	RECREATIONAL <input type="checkbox"/>	NON-REPORTABLE <input type="checkbox"/>
		COMMERCIAL <input type="checkbox"/>	
PRIMARY CAUSE	SECONDARY CAUSE		

Call the Coast Guard Infoline 1-800-368-5647 for information on **Federal Requirements for Recreational Boats**

ACCIDENT DESCRIPTION

DESCRIBE WHAT HAPPENED (SEQUENCE OF EVENTS. INCLUDE FAILURE OF EQUIPMENT. INCLUDE A DIAGRAM IF NEEDED. CONTINUE ON ADDITIONAL SHEETS IF NECESSARY. INCLUDE ANY INFORMATION REGARDING THE INVOLVEMENT OF ALCOHOL AN/OR DRUGS IN CAUSING OR CONTRIBUTING TO THE ACCIDENT. INCLUDE ANY DESCRIPTIVE INFORMATION ABOUT THE USE OF PFD'S.)

An agency may not conduct or sponsor and a person is not required to respond to an information collection, unless it displays a currently valid OMB Control Number. The Coast Guard estimates that the average burden for this report form is 30 minutes. You may submit any comments concerning the accuracy of this burden estimate or any suggestions for reducing the burden to: Commandant (G-OPB-1), U.S. Coast Guard, Washington, DC 20593-0001 or Office of Management and Budget, Paperwork Reduction Project (2115-0010), Washington, DC 20503.

THIS PAGE WAS LEFT BLANK
INTENTIONALLY

Glossary of Terms

Aft: In, near, or toward the stern of a boat.

Aground: A boat stuck on the bottom.

Amidships: In or toward the part of a boat midway between the bow and stern.

Anchor: A specially shaped heavy metal device designed to dig efficiently into the bottom under a body of water and hold a boat in place.

Anchorage: An area specifically designated by governmental authorities in which boats may anchor.

Ashore: On shore.

Astern: Behind the boat, to move backwards.

Athwartship: At right angles to the center line of the boat.

Barnacles: Small, hard-shelled marine animals which are found in salt water attached to pilings, docks and bottoms of boats.

Beam: The breadth of a boat usually measured at its widest part.

Bearing: The direction of an object from the boat, either relative to the boat's direction or to compass degrees.

Berth: A bunk or a bed on a boat.

Bilge: The bottom of the boat below the flooring.

Bilge Pump: A pump that removes water that collects in the bilge.

Boarding: Entering or climbing into a boat.

Boarding Ladder: Set of steps temporarily fitted over the side of a boat to assist persons coming aboard.

Boat Hook: Short shaft of wood or metal with a hook fitting at one end shaped to aid in extending one's reach from the side of the boat.

Bow: The front end of a boat's hull.

Bow Line: A line that leads forward from the bow of the boat.

Bow Rail: Knee high rails of solid tubing to aid in preventing people from falling overboard.

Bridge: The area from which a boat is steered and controlled.

Bridge Deck: A deck forward and usually above the cockpit deck.

Broach: When the boat is sideways to the seas and in danger of capsizing; a very dangerous situation that should be avoided.

Bulkhead: Vertical partition or wall separating compartments of a boat.

Cabin: Enclosed superstructure above the main deck level.

Capsize: When a boat lays on its side or turns over.

Chock: A deck fitting, usually of metal, with inward curving arms through which mooring or anchor lines are passed so as to lead them in the proper direction both on board and off the boat.

Cleat: A deck fitting, usually of metal with projecting arms used for securing anchor and mooring lines.

Closed Cooling System: A separate supply of fresh water that is used to cool the engine and circulates only within the engine.

Coaming: A vertical piece around the edges of cockpit, hatches, etc. to stop water on deck from running below.

Cockpit: An open space, usually in the aft deck, outside of the cabin.

Companionway: Opening in the deck of a boat to provide access below.

Compartment: The interior of a boat divided off by bulkheads.

Cradle: A framework designed to support a boat as she is hauled out or stored.

Cutlass Bearing: A rubber bearing in the strut that supports the propeller shaft.

Deck: The floor-like platform of a boat that covers the hull.

Displacement: The volume of water displaced by the hull. The displacement weight is the weight of this volume of water.

Draft: The depth of water a boat needs to float.

Dry Rot: A fungus attack on wood areas.

Dry-dock: A dock that can be pumped dry during boat construction or repair.

Electrical Ground: A connection between an electrical connector and the earth.

Engine Beds: Sturdy structural members running fore and aft on which the inboard engines are mounted.

EPIRB: Emergency Position Indicating Radio Beacon. Operates as a part of a worldwide satellite distress system.

Even Keel: When a boat floats properly as designed.

Fathom: A measure of depth. One Fathom = 6 feet.

Fender: A soft object of rubber or plastic used to protect the topsides from scarring and rubbing against a dock or another vessel.

Fend off: To push or hold the boat off from the dock or another boat.

Flying Bridge: A control station above the level of the deck or cabin.

Flukes: The broad portions of an anchor which dig into the ground.

Fore: Applies to the forward portions of a boat near the bow.

Foundering: When a boat fills with water and sinks.

Freeboard: The height from the waterline to the lowest part of the deck.

Galley: The kitchen of a boat.

Grab Rail: Hand hold fittings mounted on cabin tops or sides for personal safety when moving around the boat, both on deck and below.

Ground Tackle: A general term including anchors, lines, and other gear used in anchoring.

Grounds: A boat touches the bottom.

Gunwale: The upper edge of a boat's side.

Hand Rail: Rail mounted on the boat, for grabbing with your hand, to steady you while walking about the boat.

Harbor: An anchorage which provides reasonably good protection for a boat, with shelter from wind and sea.

Hatch: An opening in the deck with a door or lid to allow for access down into a compartment of a boat.

Head: A toilet on a boat.

Heat Exchanger: Used to transfer the heat that is picked up by the closed cooling system to the raw cooling water.

Helm: The steering and control area of a boat.

Hull: The part of the boat from the deck down.

Inboard: A boat with the engine mounted within the hull of the boat. Also refers to the center of the boat away from the sides.

Inboard/outboard: Also stern drive or I/O. A boat with an inboard engine attached to an outboard drive unit.

Keel: A plate or timber plate running lengthwise along the center of the bottom of a boat.

Knot: Unit of speed indicating nautical miles per hour. 1 knot = 1 nautical mile per hour (1.15 miles per hour). A nautical mile is equal to one minute of latitude: 6076 feet. Knots times 1.15 equals miles per hour. Miles per hour times .87 equals knots.

Lay-up: To decommission a boat for the winter (usually in northern climates).

Leeward: The direction toward which the wind is blowing.

Length On The Waterline (L.w.l.): A length measurement of a boat at the waterline from the stern to where the hull breaks the water near the bow.

Limber Hole: A passage cut into the lower edges of floors and frames next to the keel to allow bilge water to flow to the lowest point of the hull where it can be pumped overboard.

Line: The term used to describe a rope when it is on a boat.

Lists: A boat that inclines to port or starboard while afloat.

L.O.A.: Boat length overall.

Locker: A closet, chest or box aboard a boat.

Loran: An electronic navigational instrument which monitors the boat's position using signals emitted from pairs of transmitting stations.

Lunch hook: A small light weight anchor typically used instead of the working anchor. Normally used in calm waters with the boat attended.

Midships: The center of the boat.

Marina: A protected facility primarily for recreational small craft.

Marine Ways or Railways: Inclined planes at the water's edge onto which boats are hauled.

Moored: A boat secured with cables, lines or anchors.

Mooring: An anchor permanently embedded in the bottom of a harbor that is used to secure a boat.

Nautical Mile: A unit of measure equal to one minute of latitude. (6076 feet)

Nun Buoy: A red or red-striped buoy of conical shape.

Outboard: A boat designed for an engine to be mounted on the transom. Also a term that refers to objects away from the center line or beyond the hull sides of a boat.

Pad Eye: A deck fitting consisting of a metal eye permanently secured to the boat.

Pier: A structure which projects out from the shoreline.

Pile or Piling: A long column driven into the bottom to which a boat can be tied.

Pitching: The fore and aft rocking motion of a boat as the bow rises and falls.

Pitch: The measure of the angle of a propeller blade. Refers to the theoretical distance the boat travels with each revolution of the propeller.

P.F.D.: Personal Flotation Device.

Port: The left side of the boat when facing the bow.

Porthole (port): The opening in the side of a boat to allow the admittance of light and air.

Propeller: A device having two or more blades that is attached to the engine and used for propelling a boat.

Propeller Shaft: Shaft which runs from the back of the engine gear box, aft, through the stuffing box, shaft log, struts, and onto which the propeller is attached.

Pyrotechnic Distress Signals: Distress signals that resemble the brilliant display of flares or fireworks.

Raw Water Cooled: Refers to an engine cooling system that draws seawater in through a hull fitting or engine drive unit, circulates the water in the engine, and then discharges it overboard.

Reduction Gear: Often combined with the reverse gear so that the propeller turns at a slower rate than the engine.

Reverse Gear: Changes the direction of rotation of the propeller to provide thrust in the opposite direction for stopping the boat or giving it sternway.

Roll: A boat's sideways rotational motion in rough water.

Rope Locker: A locker, usually located in the bow of a boat, used for stowing the anchor line or chain.

Rubrail: Railing (often rubber or hard plastic) that runs along the boat's sheer to protect the hull when coming alongside docks, piers, or other boats.

Rudder: A moveable flat surface that is attached vertically at or near the stern for steering.

Sea anchor: An anchor that does not touch the bottom. Provides drag to hold the bow in the most favorable position in heavy seas.

Scupper: An opening in the hull side or transom of the boat through which water on deck or in the cockpit is drained overboard.

Sea cock: Safety valves installed just inside the thru-hull fittings and ahead of the piping or hose running from the fittings.

Shaft Log: Pipe through which the propeller shaft passes.

Sheer: The uppermost edge of the hull.

Sling: A strap which will hold the boat securely while being lifted, lowered, or carried.

Slip: A boat's berth between two pilings or piers.

Sole: The deck of a cockpit or interior cabin.

Spring Line: A line that leads from the bow aft or from the stern forward to prevent the boat from moving ahead or astern.

Starboard: The right side of a boat when facing the bow.

Steerageway: Sufficient speed to keep the boat responding to the rudder or drive unit.

Stem: The vertical portion of the hull at the bow.

Stern: The rear end of a boat.

Stow: To pack away neatly.

Stringer: Longitudinal members fastened inside the hull for additional structural strength.

Strut: Mounted to the hull which supports the propeller shaft in place.

Strut Bearing: See "cutlass bearing."

Stuffing Box: Prevents water from entering at the point where the propeller shaft passes through the shaft log.

Superstructure: Something built above the main deck level.

Swamps: When a boat fills with water from over the side.

Swimming Ladder: Much the same as the boarding ladder except that it extends down into the water.

Taffrail: Rail around the rear of the cockpit.

Thru-hull: A fitting used to pass fluids (usually water) through the hull surface, either above or below the waterline.

Topsides: The side skin of a boat between the waterline or chine and deck.

Transom: A flat stern at right angles to the keel.

Travel Lift: A machine used at boat yards to hoist boats out of and back into the water.

Trim: Refers to the boat's angle or the way it is balanced.

Trough: The area of water between the crests of waves and parallel to them.

Twin-Screw Craft: A boat with two propellers on two separate shafts.

Underway: When a boat moves through the water.

Wake: Disrupted water that a boat leaves astern as a result of its motion.

Wash: The flow of water that results from the action of the propeller or propellers.

Waterline: The plane of a boat where the surface of the water touches the hull when it is afloat on even keel.

Watertight Bulkhead: Bulkheads secured so tightly so as not to let water pass.

Wharf: A structure generally parallel to the shore.

Working Anchor: An anchor carried on a boat for most normal uses. Refers to the anchor used in typical anchoring situations.

Windlass: A winch used to raise and lower the anchor.

Windward: Toward the direction from which the wind is coming.

Yacht Basin: A protected facility primarily for recreational small craft.

Yaw: When a boat runs off her course to either side.

THIS PAGE WAS LEFT BLANK
INTENTIONALLY

Troubleshooting Guide

PROBLEM	CAUSE & SOLUTION
CONTROL PROBLEMS	
<p>Outdrive power steering over steers or does not respond properly.</p>	<ul style="list-style-type: none"> • The steering cable housing is bound near the transom. Free the cable and make sure no cables or wire harnesses are attached to it. • The steering cable is kinked, corroded or worn. Replace cable. • The power steering sensor valve is corroded or sticking. Service sensor valve. • The outdrive steering spindle is binding. Grease outdrive.
<p>Outdrive power steering is slow and jerks while turning the wheel.</p>	<ul style="list-style-type: none"> • The power steering pump belt on the engine is loose. Tighten or replace the belt. • The power steering pump is low on fluid. Fill the pump and check for leaks. • The outdrive steering spindle is binding. Grease outdrive.
<p>The engine will not start with the shift control lever in neutral.</p>	<ul style="list-style-type: none"> • The control is out of adjustment & not activating the neutral safety cut out switch. • The shift control lever is not in the neutral detent. Try moving the shift lever slightly. • There is a loose wire on the neutral safety switch. Inspect wires and repair loose connections. • The starter, ignition switch or neutral safety switch is bad. Replace the defective switch.
<p>The throttle lever is hard to move.</p>	<ul style="list-style-type: none"> • The cable is worn or corroded. Replace cable • The fuel injector linkage is corroded and stiff. Lubricate the linkage. • The throttle control in the helm control is corroded and binding. Lubricate the control. • The throttle control linkage at the helm is binding against something. Check and adjust or repair binding component.
<p>The shift lever is hard to move.</p>	<ul style="list-style-type: none"> • The cable worn or corroded. Replace cable • The outdrive linkage is corroded and stiff. Lubricate the linkage. • The cable is routed incorrectly and has tight bends or is kinked. Reroute or replace the cable. • The shift control in the helm control is corroded and binding. Lubricate the control. • The shift control linkage at the helm is binding against something. Check and adjust or repair binding component. • The engine idle is too high. Adjust engine idle.

PROBLEM	CAUSE & SOLUTION
PERFORMANCE PROBLEMS	
<p>Boat is sluggish and has lost speed & RPM.</p>	<ul style="list-style-type: none"> • The boat may need to have marine growth cleaned from hull and running gear. • Propellers may be damaged & need repair. • Weeds or line around the propellers. Clean propellers. • Boat is overloaded. Reduce load. • Check for excessive water in the bilge. Pump out bilge & find & correct the problem. • One of the throttles is not responding properly and the engine is not getting full throttle. Have the throttle control system checked by a qualified marine technician.
<p>The boat vibrates at cruising speeds.</p>	<ul style="list-style-type: none"> • Propellers may be damaged & need repair. • A propeller or propeller shaft is bent. Repair or replace damaged components. • The running gear is fouled by marine growth or rope. Clean running gear. • The engines are not trimmed properly. Trim engines and outdrive.
ENGINE PROBLEMS	
<p>The engine is running too hot.</p>	<p>The raw water supply line to the pump is kinked. Replace hose.</p> <ul style="list-style-type: none"> • The engine raw water pump belt is loose or worn. Tighten or replace the belt. (Mercruiser Engines) • The engine raw water pump impeller is worn or damaged. Repair the pump. • The engine thermostat is faulty and needs to be replaced. • The fresh water cooling heat exchanger is clogged and needs to be cleaned. • The exhaust manifolds or riser water ports are clogged and need to be cleaned or the manifold or riser replaced.
<p>The engine alternator is not charging properly.</p>	<ul style="list-style-type: none"> • The engine alternator belt is loose or worn. Tighten or replace the belt. • The alternator is not charging and must be replaced. • The isolator in the charging system is not working properly. Replace the isolator. • A battery is defective and not accepting a charge.
<p>The engine suddenly will not operate at or above cruise RPM.</p>	<ul style="list-style-type: none"> • The engine emergency system has been activated. The on board computer has sensed a problem and has limited the RPM to protect the engine. Find and correct the problem. • The tachometer is bad and needs to be replaced. • The throttle control is out of adjustment. Check the throttle adjustment or cable.
<p>The engine is losing RPM. The boat is not overloaded and the hull bottom and running gear are clean and in good condition.</p>	<ul style="list-style-type: none"> • The fuel filter could be dirty. Inspect and replace the fuel filter. • The electronic engine control system on the engine is malfunctioning. Repair the engine control system.

PROBLEM	CAUSE & SOLUTION
ENGINE PROBLEMS	
<p>The engine suddenly shuts down and won't restart.</p>	<ul style="list-style-type: none"> The automatic fire extinguisher in the engine compartment has activated and the engine was shut down by the extinguishing agent. Check the monitor panel for no green light. If the green light is out, wait 15 minutes, if safe to do so, to ensure a possible fire is out. Then inspect the engine compartment. Correct any problems found and then ventilate the engine compartment and start the engine.
<p>The engine runs too cold.</p>	<ul style="list-style-type: none"> The thermostat is faulty. Replace thermostat. The temperature gauge is not reading properly. Replace the temperature gauge or sender.
<p>The engine starter will not operate.</p>	<ul style="list-style-type: none"> The battery switch is off. Turn on switch. The shift control is not fully engaged in neutral. Move shifter from forward to neutral and try again. The fuse or circuit breaker for the starting circuit is blown. Reset the breaker or replace the fuse. Repair circuit if necessary The battery is weak or low. Charge or replace battery. Corroded or loose battery connections. Tighten, clean and protect connections.
ACCESSORY PROBLEMS	
<p>The fresh water pump runs, but will not pump water.</p>	<ul style="list-style-type: none"> The water tank is empty. Fill the tank. The in-line strainer for the pump is clogged. Clean the strainer. The intake hose is damaged and sucking air. Replace or repair the hose. The pump is defective. Repair or replace the pump.
<p>The fresh water pump switch is on but the pump fails to run.</p>	<ul style="list-style-type: none"> The water system circuit breaker has tripped. Reset the circuit breaker. •There is a loose or corroded wiring connection. Find and repair the bad connection The thermal breaker on the pump is tripped. Repair or replace pump. The pressure switch on the pump has failed. Replace the pressure switch. The pump is defective. Repair or replace the pump.
<p>The fresh water pump fails to turn off after all outlets are closed.</p>	<p>There is a leak in a pressure line or outlet. Repair the leak.</p> <ul style="list-style-type: none"> There is an air leak in the intake line. Repair the air leak. The pressure switch is defective. Replace the pressure switch. The voltage to the pump is low. Check for corroded or loose wiring connections or low battery. The strainer is clogged. Clean strainer. The pump is defective. Repair or replace the pump.

PROBLEM	CAUSE & SOLUTION
ACCESSORY PROBLEMS	
<p>Reduction in water flow from the bilge pump.</p>	<ul style="list-style-type: none"> • Impeller screen plugged with debris. Clean screen at the base of the pump. • The discharge hose is pinched or clogged. Check discharge hose and clean or repair. • Discharge hose is sagging below the pump and creating an airlock. Reroute hose so it runs uphill from the pump to the thru-hull fitting. • Low voltage to the pump. Check the battery and wire connections.
<p>The automatic float switch on the bilge pump raises but does not activate the pump.</p>	<ul style="list-style-type: none"> • The circuit breaker near the battery switch has blown. Reset the circuit breaker. • The battery is dead. Charge or replace the battery. • The pump impeller is jammed by debris. Clean pump impeller housing. • The wire connections in the bilge have corroded. Replace connectors and secure above the bilge waterline. • The automatic switch is defective. Replace the switch. • The pump is defective. Replace pump.
<p>The bilge pump will not run when the manual switch is activated.</p>	<ul style="list-style-type: none"> • The circuit breaker supplying the switch has tripped. Replace or reset the circuit breaker. • The battery switch is off. Turn on the battery switch and bilge pump breaker. • The pump impeller is jammed by debris. Clean pump impeller housing. • The wire connections in the bilge have corroded. Replace connectors and secure above the bilge waterline. • The switch is defective. Replace the switch. • The pump is defective. Replace pump.
<p>Porcelain head will not add water.</p>	<ul style="list-style-type: none"> • The fresh water pump is not activated. Turn on fresh water pump. • The fresh water tank is empty. Fill fresh water tank. • The Add Water button in the control panel is not working. Replace control panel. • The solenoid on the head fresh water valve is defective. Replace fresh water supply valve.
<p>Porcelain head will not flush.</p>	<ul style="list-style-type: none"> • Electric head circuit breaker is tripped. Turn on breaker. • The holding tank is full. Pump out the holding tank. • There is bad connection at the head pump or the switch. Repair the connection. • The Flush button in the control panel is not working. Replace control panel. • The head pump is defective. Replace the pump.

PROBLEM	CAUSE & SOLUTION
ACCESSORY PROBLEMS	
Holding tank will not empty.	<ul style="list-style-type: none"> • Overboard discharge valve in the bilge is closed. Open discharge valve. • Holding tank vent is clogged. Replace vent filter or clean vent. • There is a vacuum leak in the hose from the holding tank to the deck pump out fitting. Tighten loose fittings or replace damaged hoses.
Excessive odor from marine head.	<ul style="list-style-type: none"> • Back pressure in the holding tank. Pump out holding tank or replace the vent filter. • Waste is in the discharge hose. Flush enough to move waste to the holding tank, particularly at the end of each day. • No deodorizer in the holding tank. Add deodorizer to the holding tank each time it is pumped out. • The waste in the tank is over two weeks old. Pump the holding if it has contained waste for two weeks or more.
The air conditioner runs for a short time & then cuts out.	<ul style="list-style-type: none"> • The intake scoop strainer for the raw water system is clogged with weeds or debris. Back down the boat to clear debris or clean the scoop strainer. • The air conditioner pump sea strainer is clogged. Clean the strainer. • The raw water supply thru hull valve is closed. Open the valve. • The raw water system is air-bound. Make sure the thru hull valve is open and run the boat above 15 m.p.h. The speed scoop on the thru hull fitting will force the air lock out of the system. • The air conditioner raw water pump is not pumping and needs to be repaired or replaced.
The refrigerator compressor runs frequently and the house battery life seems shorter than it should be whenever the refrigerator is operating on DC power.	<ul style="list-style-type: none"> • The thermostat in the refrigerator is set too cold. Check the temperature in the refrigerator and set the thermostat to a warmer setting if necessary. • The door gasket is dirty or moldy and not sealing properly. Clean or replace the door seal. • The battery is weak and not providing the proper voltage to the refrigerator compressor. Replace the battery. • The refrigerator is defective. Replace the refrigerator.
The carbon monoxide detector sounds the alarm when the engines or generator are running.	<ul style="list-style-type: none"> • The canvas curtains are up and none of the forward facing vents are open, allowing carbon monoxide to accumulate in the cockpit and cabin. Open the deck hatch, clear connector and side curtains to provide proper ventilation. • The boat is operating at slow speed and the wind is on the stern pushing CO into the cockpit and cabin. Increase boat speed or change heading if possible. • The carbon monoxide detector is defective and needs to be calibrated by the manufacturer or replaced. Have the boat checked by a professional before condemning the CO monitor.

PROBLEM	CAUSE & SOLUTION
<p>No AC power to cabin breaker panel and shore cord is properly connected.</p>	<ul style="list-style-type: none"> • The breaker at the shore outlet is off or has tripped. Activate breaker. • The circuit breaker at the transom shore power inlet connection is off. Turn on the circuit breaker. • The shore power cord is damaged or defective. Replace the cord. • The ELCI at the inlet connection has detected a fault in the electrical system and the breaker has tripped. Contact a qualified marine electrician to find and correct the problem.
<p>The cabin Main breaker for AC power trips when activating the system from shore power.</p>	<ul style="list-style-type: none"> • The AC accessory breakers are on and the power surge is tripping the breaker. Turn off all AC accessory breakers and reactivate main breaker. • The main breaker is defective. Contact a qualified marine electrician to replace the breaker.
<p>The cabin AC main breaker activates the panel but trips while using accessories.</p>	<ul style="list-style-type: none"> • There are too many AC accessories activated causing excess amperage draw. Manage AC accessory use to reduce excess amperage draw. • Voltage supplied from the shore outlet is low or high. Check the voltage. Contact the marina operator or qualified marine electrician to correct the problem. • The main breaker is defective. Contact a qualified marine electrician to replace the breaker.
<p>No AC power at cabin outlets</p>	<ul style="list-style-type: none"> • Outlet breaker in cabin AC panel is off. Activate breaker. • Ground fault interrupter has tripped. Push reset button on outlet to reset. • Accessory powered by the outlet has a fault that is tripping the interrupter. Turn the breaker in the cabin AC panel off and contact a qualified marine electrician to repair the defective accessory. Replace defective accessory. • The GFI outlet is defective. Contact a qualified marine electrician to replace the outlet.
GENERATOR PROBLEMS	
<p>The generator will not start.</p>	<ul style="list-style-type: none"> • House battery is not charged. Charge or replace battery. • The generator fuel supply valve is off. Turn on fuel supply valve. • The fuel level is too low in the fuel tank. Fill the fuel tank.
<p>The generator runs for a short time and shuts down.</p>	<ul style="list-style-type: none"> • There is a problem with the generator and the emergency shut down system has activated to shut down the generator. Find and correct the problem, then restart the generator. • The fuel level is too low in the fuel tank that supplies the generator. Fill the fuel tank. • The generator is overloaded. Manage AC accessory use to reduce excess amperage draw. <p>Note: The fuel withdrawal tube for the generator is shorter than the main engine tubes. Therefore, the generator will run out of fuel before the boat engines. This is to prevent the generator from consuming reserve fuel.</p>

Medallion Gauges Quick Reference Guide

Revised: 10/2/13

Overview:

Medallion gauges are digital instruments that use CAN data to deliver extremely accurate engine information. They are connected directly to the engine's computer using one of the following data streams:

- J1939 Volvo mechanical engines (Non-EVC)
- NMEA 2000 Volvo EVC engines
- SmartCraft Mercury DTS and mechanical engines

Each set of gauges has a harness that connects all of the gauges together and to the incoming data. The tachometer is the "brain" of the system. It processes all of the incoming information and then distributes specific data downstream to the other gauges.

Backlighting is controlled from either the Nav/Anchor light switch or the Panel Lights switch.

Some of the data does not come from the engine.

- Pitot speed comes from the pitot tube connected at the outdrive up to a pitot sensor mounted to the engine (Mercury DTS) or to the gauge harness (all others). This does not apply to boats without speedometers.
- Fuel level – Non-DTS/EVC Engines: Comes directly from the fuel tank sender to an input wire on the gauge harness.
- Fuel level – DTS/EVC Engines: A unique Mercury or Volvo harness plugs into the back of the engine and runs to the fuel sender (pink signal wire ONLY...ground for sender goes to boat ground). Fuel level is processed by engine computer with the other CAN data.
- Fuel level calibration – Volvo EVC only: If the fuel level calibration is missing on a Volvo EVC engine, the 2.5" display will show dashed lines (- - -) for fuel level. Fuel levels will not work in the Medallion system until the Volvo fuel system has been calibrated. If the fuel tank calibration has been lost, it will be necessary to go into Settings and set the empty tank level, the fuel tank capacity and perform a multi-point fuel calibration. In some installations, it may be easier to connect an extra fuel sender to the sender wires rather than remove the sender. Note that all Monterey fuel tanks are either rectangular in cross section or very close to rectangular which means that all fuel senders read linearly. The calibration process will ask for 20/40/60/80/100% increments which can be measured along the length of any fuel sender regardless of length.
- Air temperature comes from a sensor connected to the gauge harness
- Depth and water temperature come from the transducer (if equipped).
- Voltage is detected from power delivered at the helm and connected to the harness.

The balance of the information listed below is delivered via CAN data stream.

- RPM
- Coolant Temp
- Block Pressure (Mercury only)
- Trim Position
- Engine Hours
- Oil Pressure
- Fuel Rate
- Fuel Level (DTS/EVC only)
- Engine or Helm (Engine Helm Computer) Faults

Gauge Operation:

There are 2 types of tachometers: Graphical and Segmented. The segmented tach has no buttons on the face and the graphical tach has two black buttons on either side near the bottom.

Segmented Tach:

This tach is operated by a momentary switch on the dash with the label “Engine Data”. When the key is turned on, the gauges will power on. Simply press the Engine Data switch to scroll through each item in the display of the tachometer. The display on the tachometer will show the engine hours for 3 seconds and then return to the last screen used each time the key is turned on.

The following screens are displayed on the segmented tachometer:

- Hours
- Coolant Temp
- Block Pressure (Mercury only)
- Oil Pressure (150HP and up)
- Depth
- Fuel Rate (Fuel symbol + “R”)
- Fuel Level (Fuel symbol + “L”)
- Voltage
- Air Temp (“A”)
- Water Temp (“W”)
- RPM

Calibrating Trim on the Segmented Tach:



1. To calibrate drive/outboard trim on the segmented tach:
2. Toggle to the Trim display using the "Engine Data" switch

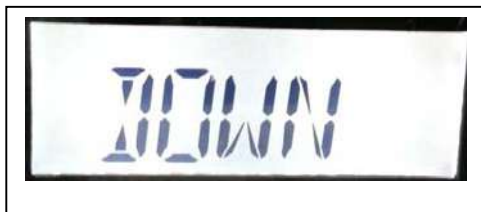

3. Hold the "Engine Data" switch down for 5 seconds. The display will show "Down".

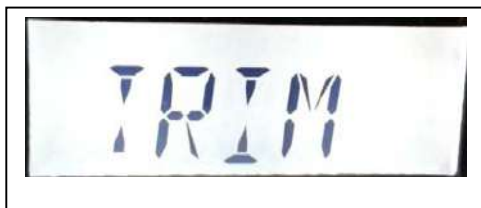

4. Trim the drive all the way down. Press the "Engine Data" switch. The display will show "Trim".



5. Trim the drive to the max desired trim point. Press the "Engine Data" switch. The display will show "Trail".



6. Trim the drive all the way up. Press the "Engine Data" switch. The display will show "Done".

7. Calibration Complete!

Graphical Tach:

This tach is operated using the buttons on the front of the gauge. Pressing the left button will scroll data to the left, pressing the right button will scroll data to the right.

Startup:

Note that on Mercury engines equipped with the graphical tachometer, a “Service Soon” message will flash when the key is first turned on. This is the required EPA emissions check function and is normal. Volvo engines do not flash this message because this function is covered by the 2.5” display.

Setup Mode:

Press and hold both buttons to enter setup mode.

This will allow you to adjust the settings in the tach.

The following items can be adjusted and their appropriate settings are detailed below.

- Units English/Metric
- Engine Can be assigned either as port, stbd, or single
- LCD Animation Turns the scrolling Monterey emblem on or off between data screens
- LCD Screens Enable/Disable data screens (See below for screen details)
- LCD Backlight Adjust brightness of display (Customer to set)
- LCD Contrast Adjust contrast of display (Customer to set)
- Calibrate Trim Calibrates trim needle and digital trim position by setting marker points at Full Down, Max Trim, and Full Up/Trailer. NOTE: Max trim is the highest level of trim the boat would normally be operated at.
- Gauge Information Software revision
- Diagnostics Troubleshooting (Medallion technician only)
- Restore Defaults Resets gauge to defaults
- Exit Setup Return to normal operation

Graphical Trim Calibration:

***Note that if configuring with dual engines, both drives should be calibrated at the same time.**



1. Toggle to SETUP menu by pressing and holding both buttons on the tachometer.



2. Toggle to the TRIM CALIBRATION option by pressing the left button. Enter by pressing the right button.



3. The display will show "FULL DOWN". Trim the drive all the way down. Press either button.

4. The display will show "Max Trim". Trim the drive to the max desired trim point. Press either button.



5. The display will show "UP/TRAILER". Trim the drive all the way up. Press either button.

6. Calibration Complete!

LCD Screens:

The following grid shows how each data screen should be set for single and twin engine boats.

Screen	Single	Twin Engines	
		Port	Starboard
Clock	Disabled	Disabled	Disabled
Engine Speed	Enabled	Enabled	Enabled
Vessel Speed	Enabled	Disabled	Disabled (Enabled 328SS)
Oil Pressure	Enabled	Enabled	Enabled
Engine Temperature	Enabled	Enabled	Enabled
Block Pressure	Enabled-Mercury Disabled-Volvo	Enabled-Mercury Disabled-Volvo	Enabled-Mercury Disabled-Volvo
Battery Voltage	Enabled	Enabled	Enabled
Fuel Level and Rate	Enabled	Enabled 328SS –Volvo: Enabled 328SS – Mercury: Enabled	Enabled 328SS – Volvo: Disabled 328SS-Mercury: Disabled
Trim	Enabled	Enabled	Enabled
Rudder	Disabled	Disabled	Disabled
Depth	Enabled	Disabled	Disabled (Enabled 328SS)
Air Temperature	Enabled	Disabled	Enabled
Lake Temperature	Enabled	Disabled	Disabled (Enabled 328SS)
Heading	Disabled	Disabled	Disabled
LCD Animation	Disabled	Disabled	Disabled

Troubleshooting:

Problem: Digital display and other gauges do not show correct information. Coolant temp reads “32 F”.

Issue: There is no data moving from the engine to the gauge.

- Check power to NMEA 2000 devices (if equipped).
- Check connections on NMEA 2000 tees (if equipped).
- Check plugs on engine and at gauge harness.
- Make sure battery switch is turned on.
- Listen for fuel pump when key is turned on. If fuel pump does not start, the engine computer is not powered up and no data will be broadcast to gauges.

Problem: Port gauges show starboard engine data (or vice versa), Single engine gauges do not show correct engine data.

Issue: Gauge may be set to port, starboard, or single.

- Verify in “Setup Mode” that gauge is set to the correct engine.

Problem: Speedometer reading 10 to 40mph while at rest.

Issue: Replace the Medallion 5550-12071-05 pitot sensor with the Mercury sensor and replace the 8633-00020-29 GDIG tachometer with Medallion part number 8633-00099-29

Problem: Trim menu not showing in tachometer display

Issue: Trim function may be disabled.

- Verify in “Setup Mode” that the trim option is enabled.
 - Press and hold both buttons on front of GDIG tachometer.
 - Scroll down to “LCD SCREENS”.
 - Ensure that the trim option is enabled.

Problem: Incorrect display of fuel level on dual engine, dual tank boats.

Issue: Fuel level not accurate.

- Replace 8633-00020-29 GDIG tachometer with Medallion part number 8633-00099-29.

Problem: Needles “fluttering” when key switch is first turned on.

Issue: This is caused by the stepper motor in the gauge resetting itself upon startup.

- This is a function of the gauge, no action is required.

THIS PAGE WAS LEFT BLANK
INTENTIONALLY

214/218 Super Sport

LOWER HELM SWITCH

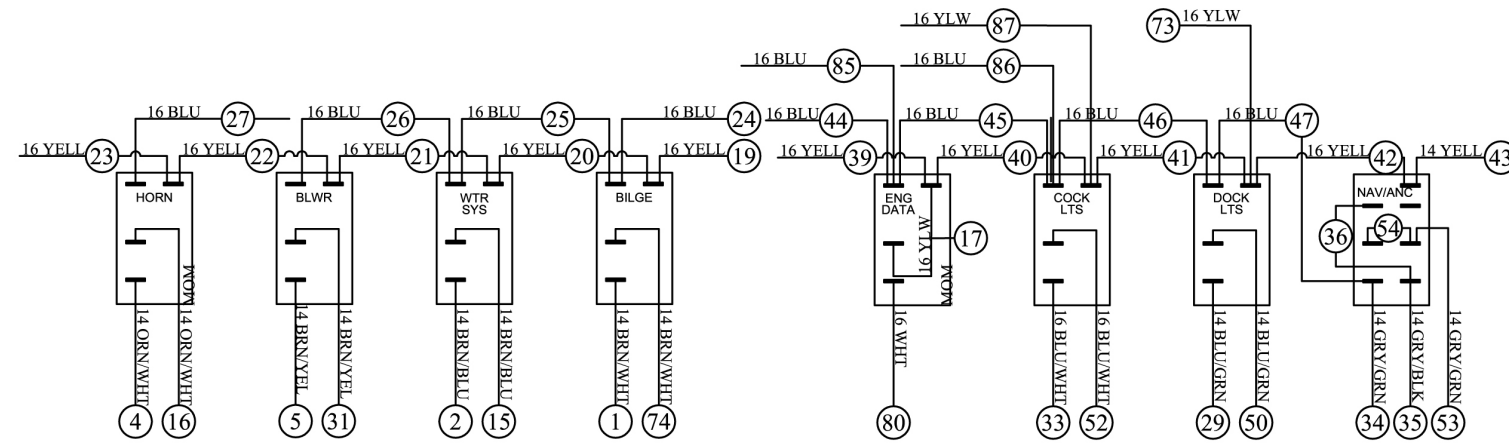

PLUG "A" 12 POS DEUTSCH DT CAP HSG 054-0030
 W/LOCKING WEDGE 054-0036
 (12) 054-0002 PIN 14-16GA

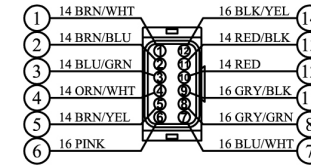

PLUG "B" 15 POS 15A MNLII MALE
 PLUG 052-2038
 (14) 052-3015 14-16GA SM SKTS

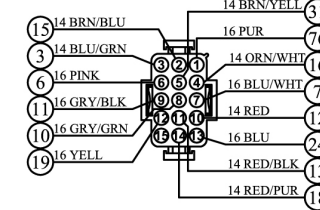

PLUG "C" 15 POS 15A MNLII FEMALE
 CAP 052-2031
 (14) 052-3017 14-16GA SM PINS

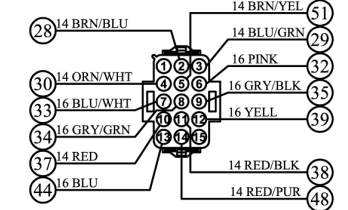

PLUG "F" 12 POS 15A MNLII
 MALE PLUG 052-2034
 (10) 052-3015 14-16GA SKTS

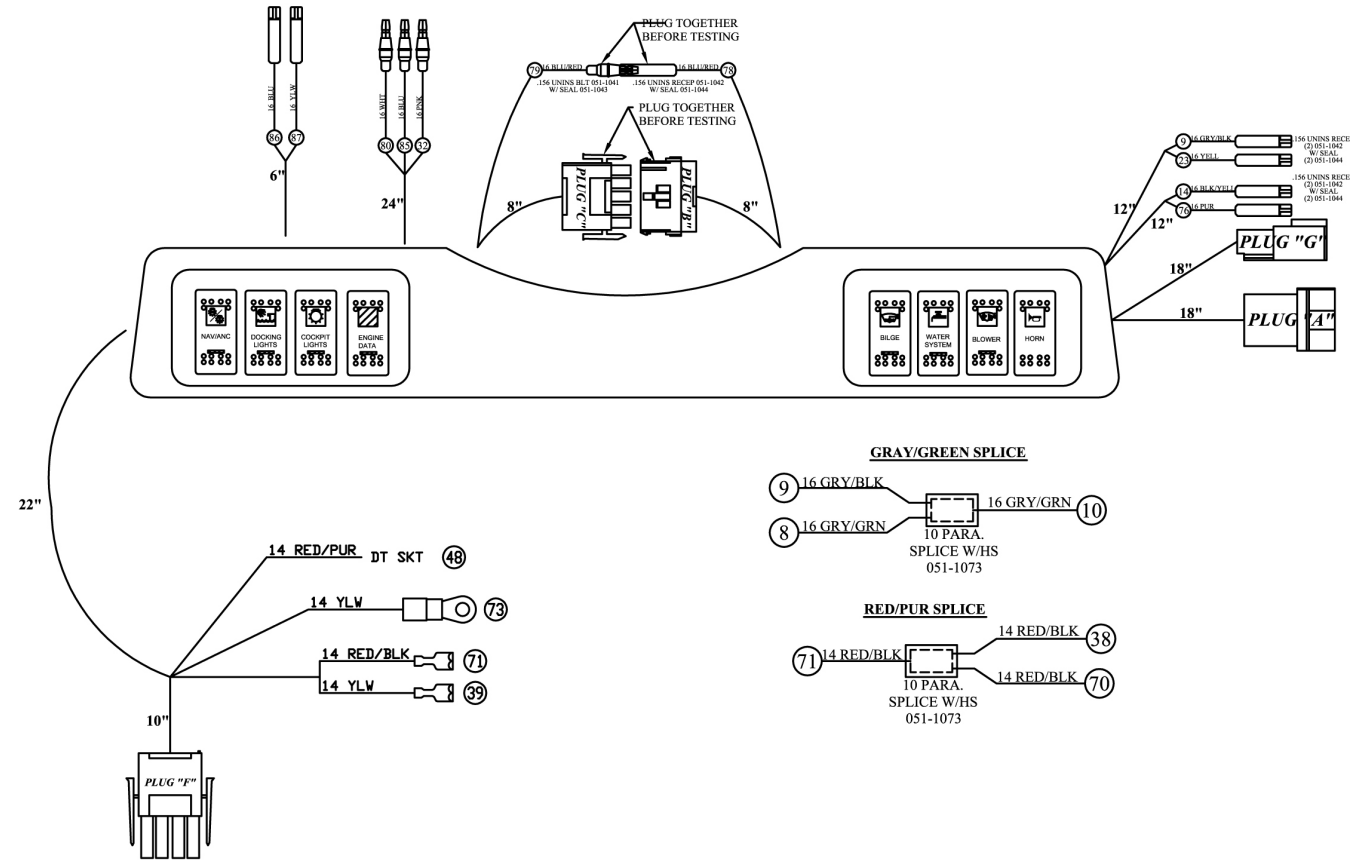
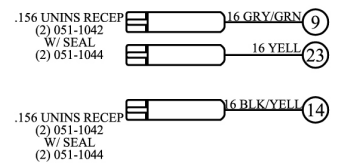
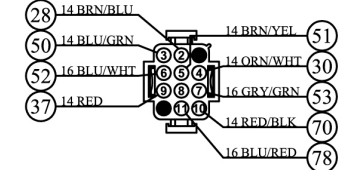

GRAY/GREEN SPLICE

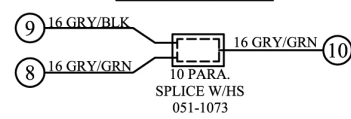

RED/PUR SPLICE

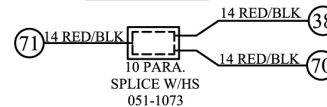

PLUG "G" 3 POS DEUTSCH DT FEMALE HSG 054-0027
 W/LOCKING WEDGE 054-0032
 (3) 054-0002 PIN 14-16GA

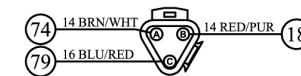

NOTES:

1. ALL WIRE MUST BE TINNED.
2. TIE WRAP ALL BREAKOUTS EVENLY.
3. TIE WRAP ALL BREAKOUTS AS SHOWN.

214/218 Super Sport

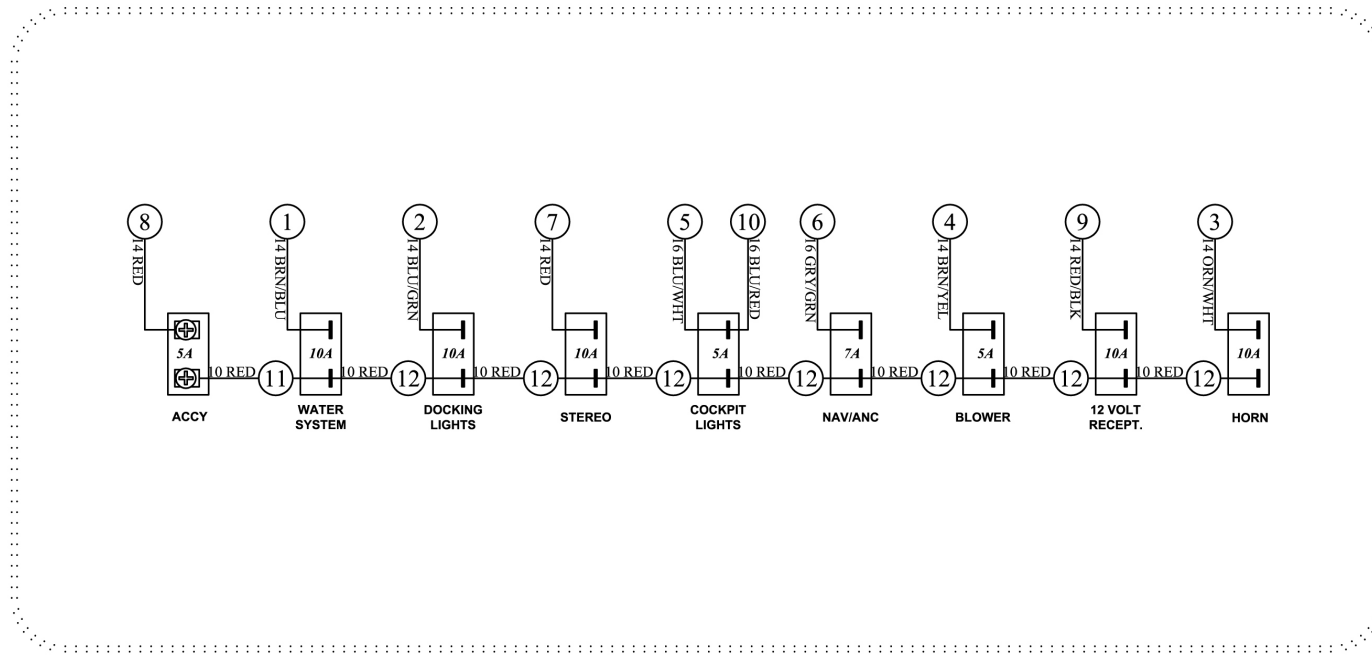
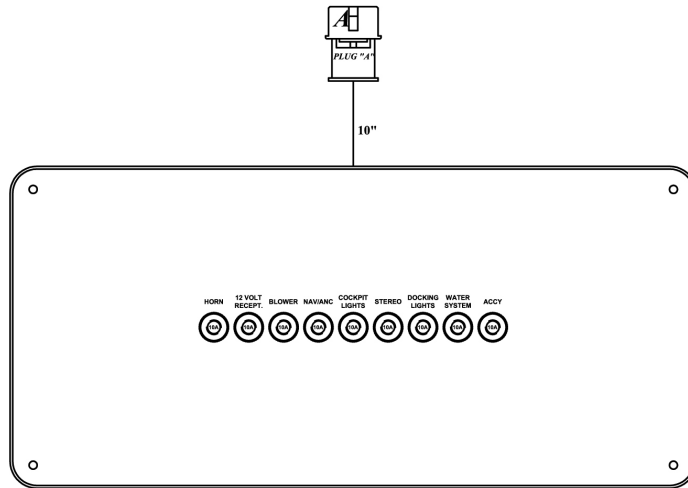

PLUG "A" 12 POS 15A MNLII
FEMALE CAP 052-2035
(10) 052-3017 14-16GA PIN

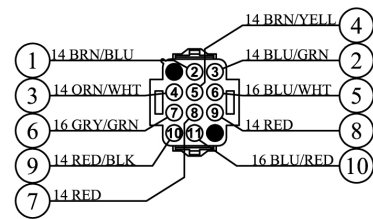

SPORTBOAT CUDDY BRKR ASSY

NOTES:

1. ALL WIRE MUST BE TINNED.
2. TIE WRAP ALL BREAKOUTS EVENLY.
3. COIL AND TIE WRAP ALL BREAKOUTS AS SHOWN.

214/218 Super Sport

COCKPIT LIGHTS HARNESS

NOTES:

1. USE ONLY WST WIRE ON HARNESS.
2. USE ONLY HEAT SHRINK TERMINALS. UNLESS NOTED
3. ALL SPLICES NEED TO BE HEATSHRINK TERMINALS
4. USE ONLY "F" COMPRESSION WATERPROOF COAX CONNECTORS.
4. HARNESS BREAKOUTS ARE ±1".
5. ADD CONDUIT/FLEX TO DASH AREAS. EXPOSING 3" AT THE ENDS OF EACH BREAKOUT.
6. LABEL ALL CONNECTORS WITH THE PROPER LETTER.
7. USE BLACK TAPE.

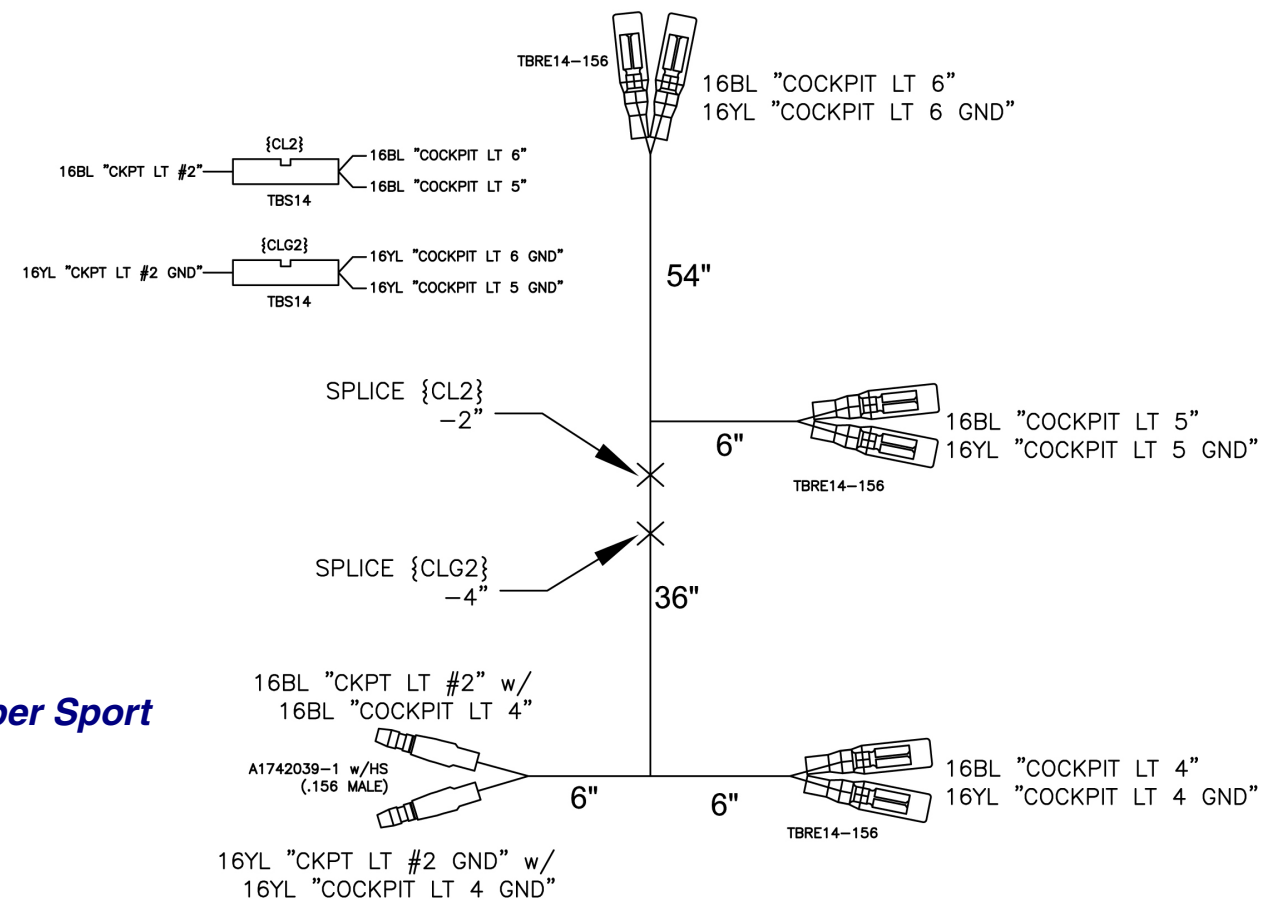
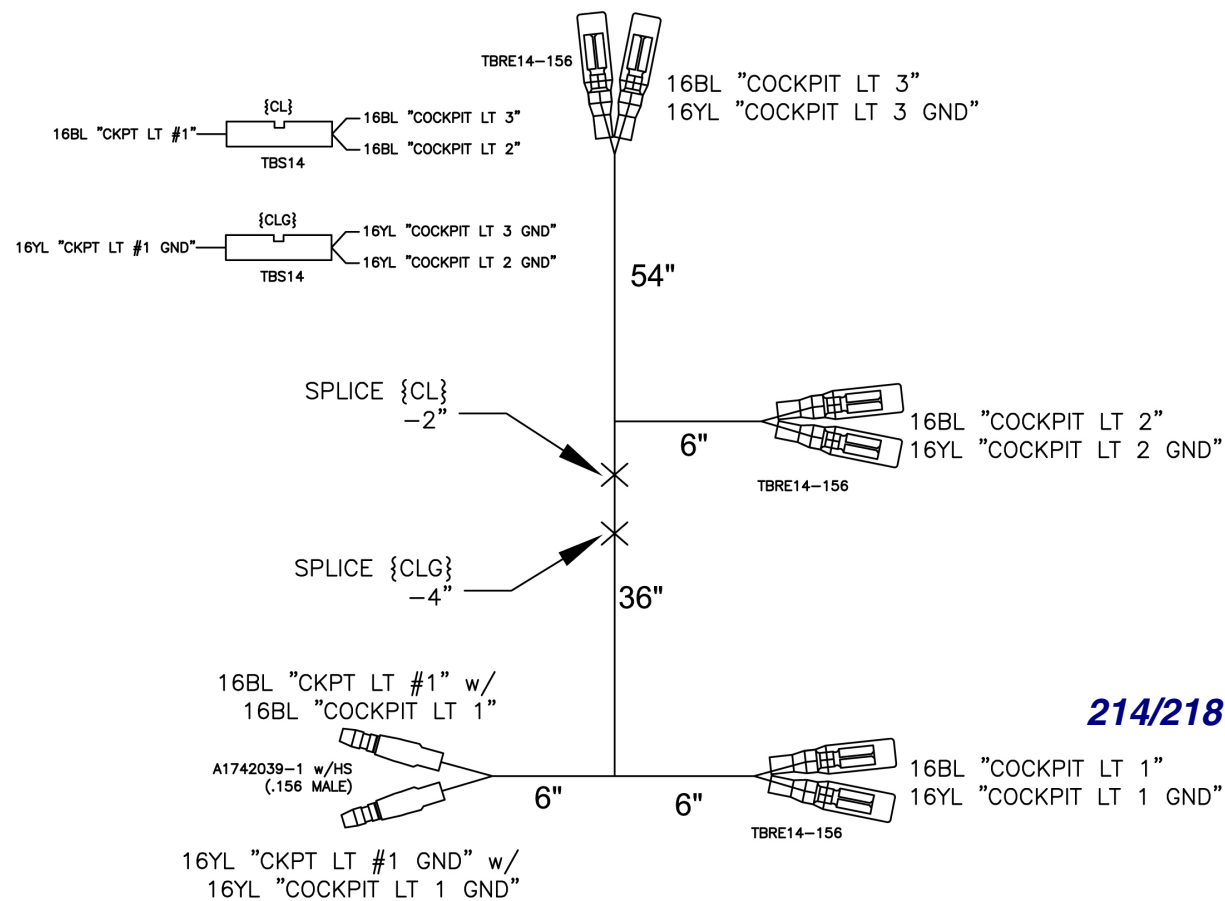
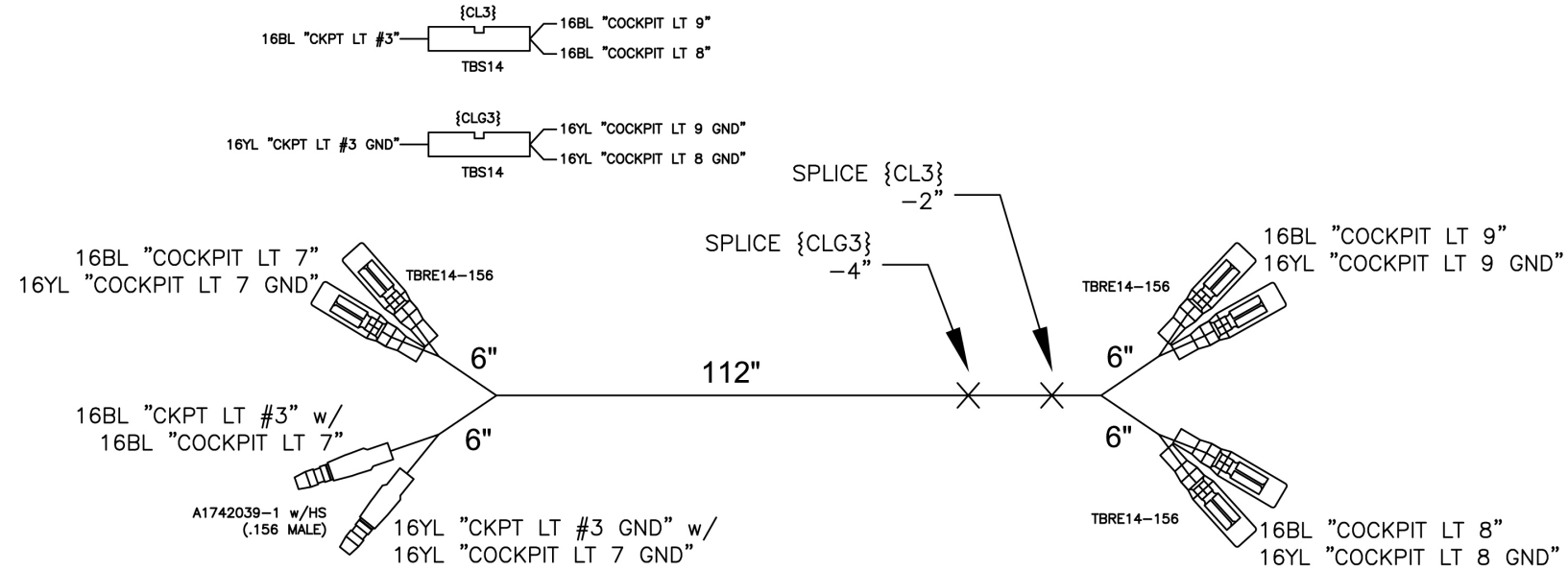

214/218 Super Sport

214/218 Super Sport

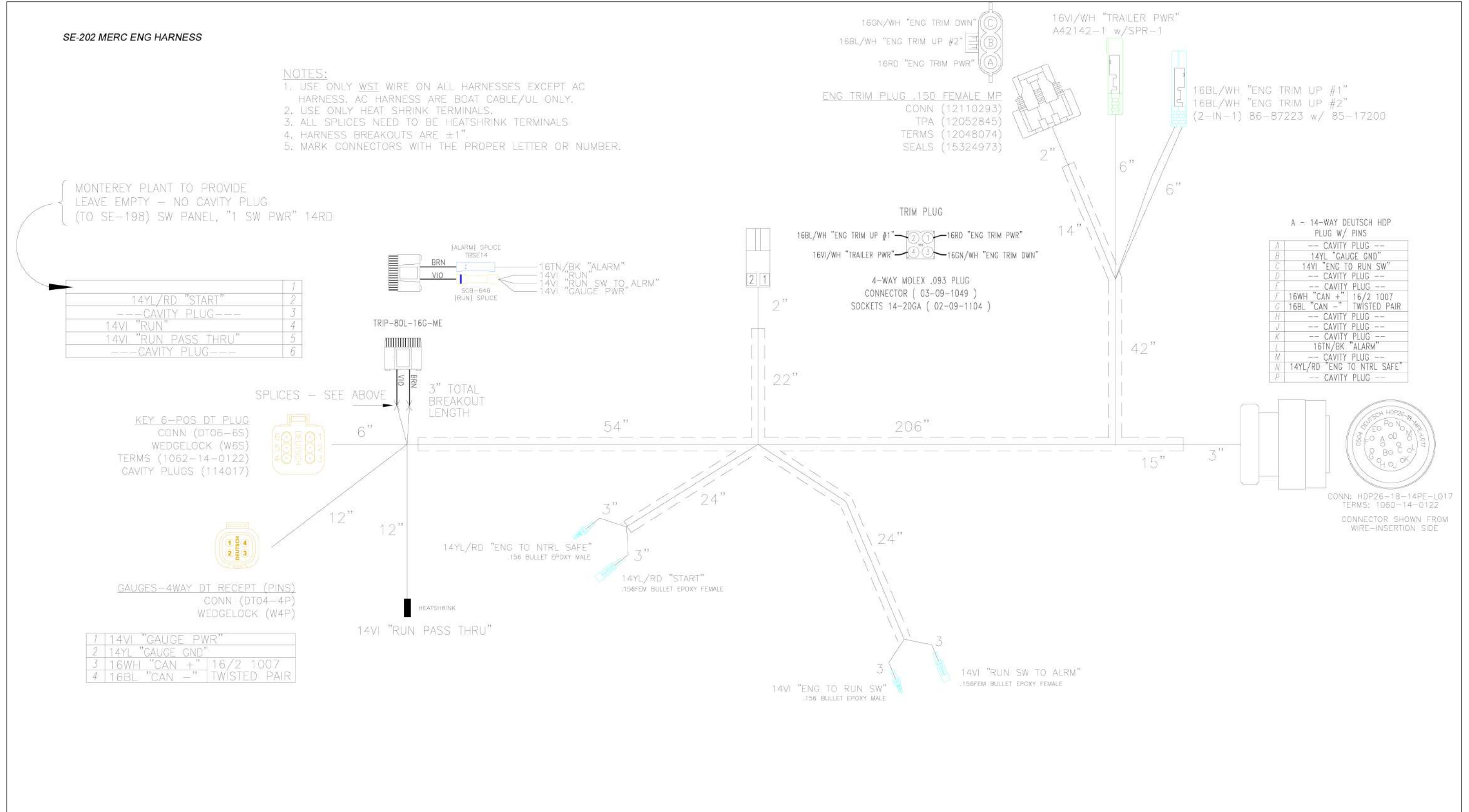

234/238 Super Sport

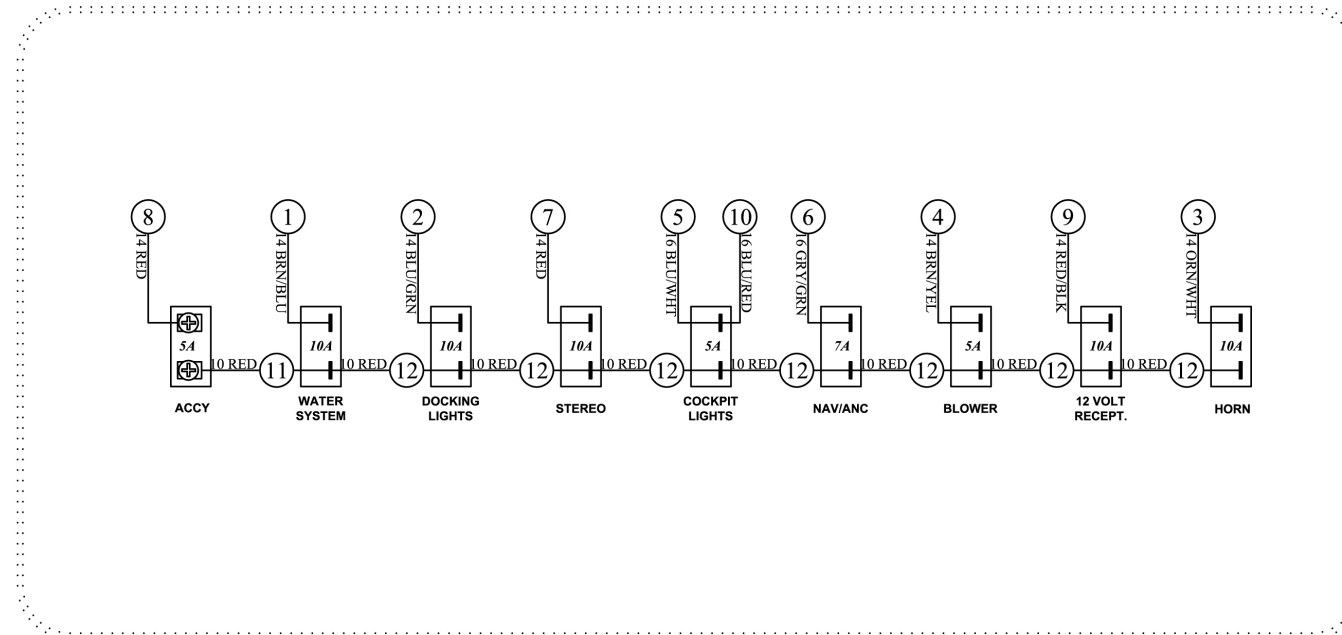
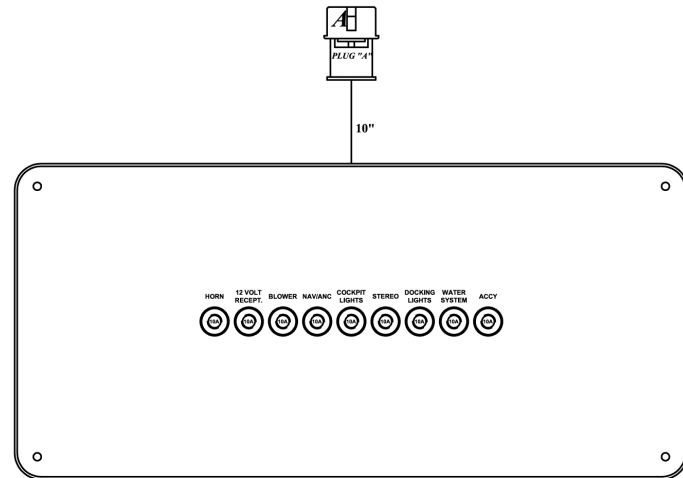

PLUG "A" 12 POS 15A MNLII
FEMALE CAP 052-2035
(10) 052-3017 14-16GA PIN

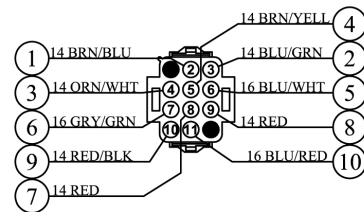

SPORTBOAT CUDDY BRKR ASSY

NOTES:

1. ALL WIRE MUST BE TINNED.
2. TIE WRAP ALL BREAKOUTS EVENLY.
3. COIL AND TIE WRAP ALL BREAKOUTS AS SHOWN.

234/238 Super Sport

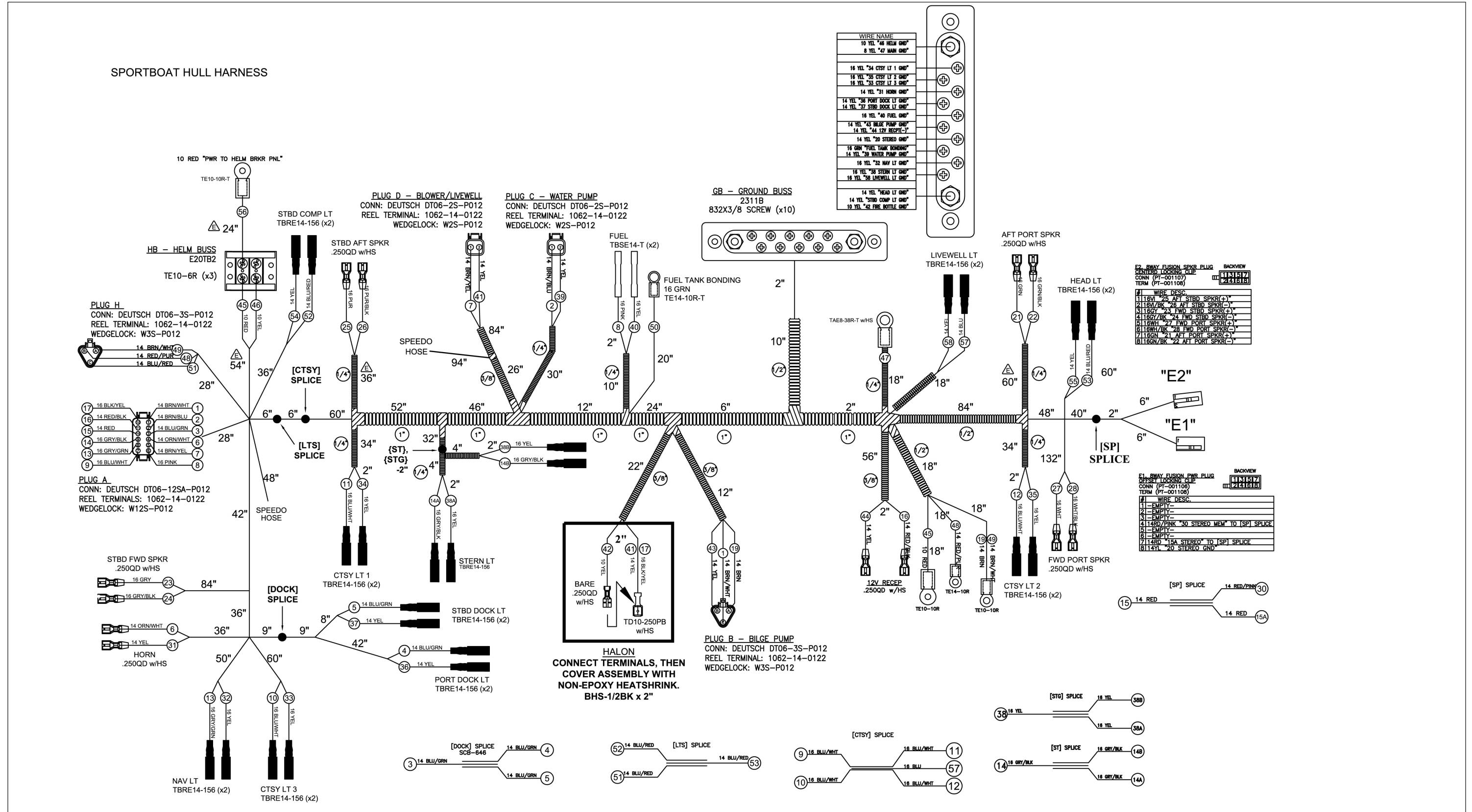

234/238 Super Sport

SE-202 MERC ENG HARNESS

NOTES:

1. USE ONLY WST WIRE ON ALL HARNESSES EXCEPT AC HARNESS. AC HARNESS ARE BOAT CABLE/UL ONLY.
2. USE ONLY HEAT SHRINK TERMINALS.
3. ALL SPLICES NEED TO BE HEATSHRINK TERMINALS.
4. HARNESS BREAKOUTS ARE ±1".
5. MARK CONNECTORS WITH THE PROPER LETTER OR NUMBER.

MONTEREY PLANT TO PROVIDE
LEAVE EMPTY - NO CAVITY PLUG
(TO SE-198) SW PANEL, "1 SW PWR" 14RD

1	14YL/RD "START"
2	---
3	---
4	14VI "RUN"
5	14VI "RUN PASS THRU"
6	---

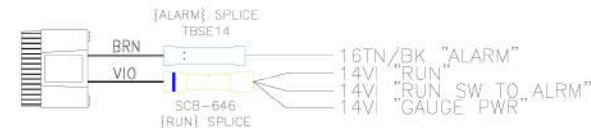

TRIP-80L-16G-ME

SPLICES - SEE ABOVE

3" TOTAL BREAKOUT LENGTH

KEY 6-POS DT PLUG
CONN (DT06-6S)
WEDGELOCK (W6S)
TERMS (1062-14-0122)
CAVITY PLUGS (114Q17)



GAUGES-4WAY DT RECEPT (PINS)
CONN (DT04-4P)
WEDGELOCK (W4P)

1	14VI "GAUGE PWR"
2	14YL "GAUGE GND"
3	16WH "CAN +"
4	16BL "CAN -"

14VI "RUN PASS THRU"

14YL/RD "ENG TO NTRL SAFE"
.156 BULLET EPOXY MALE

14YL/RD "START"
.156FEM BULLET EPOXY FEMALE

14VI "ENG TO RUN SW"
.156 BULLET EPOXY MALE

14VI "RUN SW TO ALRM"
.156FEM BULLET EPOXY FEMALE



16VI/WH "TRAILER PWR"
A42142-1 w/SPR-1

16BL/WH "ENG TRIM UP #1"
16BL/WH "ENG TRIM UP #2"
(2-IN-1) 86-87223 w/ 85-17200

TRIM PLUG

16BL/WH "ENG TRIM UP #1"
16VI/WH "TRAILER PWR"
16RD "ENG TRIM PWR"
16GN/WH "ENG TRIM DWN"

4-WAY MOLEX .093 PLUG
CONNECTOR (05-09-1049)
SOCKETS 14-20GA (02-09-1104)

A - 14-WAY DEUTSCH HDP
PLUG W/ PINS

A	---	CAVITY PLUG	---
B	14YL	"GAUGE GND"	
C	14VI	"ENG TO RUN SW"	
D	---	CAVITY PLUG	---
E	---	CAVITY PLUG	---
F	16WH	"CAN +"	16/2 1007
G	16BL	"CAN -"	TWISTED PAIR
H	---	CAVITY PLUG	---
J	---	CAVITY PLUG	---
K	---	CAVITY PLUG	---
L	16TN/BK	"ALARM"	
M	---	CAVITY PLUG	---
N	14YL/RD	"ENG TO NTRL SAFE"	
P	---	CAVITY PLUG	---



CONN: HDP26-18-14PE-L017
TERMS: 1060-14-0122
CONNECTOR SHOWN FROM WIRE-INSERTION SIDE

268 Super Sport

HARNES, EVC FUEL

NOTES:

1. USE ONLY WST WIRE ON ALL HARNESSES EXCEPT AC HARNESSES. AC HARNESSES ARE BOAT CABLE/UL ONLY.
2. USE ONLY HEAT SHRINK TERMINALS.
3. USE ONLY WATERPROOF "F" COAX CONNECTORS.
4. ALL SPLICES NEED TO BE HEATSHRINK TERMINALS.
5. ADD YELLOW TAPE TO HARNESSES TO INDICATE SPLICE POINTS.
6. HARNESSES BREAKOUTS ARE ± 1 ".
7. ADD CONDUIT/FLEX TO DASH AREAS EXPOSING 3" AT THE ENDS OF EACH BREAKOUT.
8. MARK CONNECTORS WITH THE PROPER LETTER OR NUMBER.
9. LABEL RCA CABLE ENDS WITH THE PROPER FUNCTION 1" FROM RED RCA. HIDE EXCESS RCA CABLE INSIDE THE CONDUIT AREA.

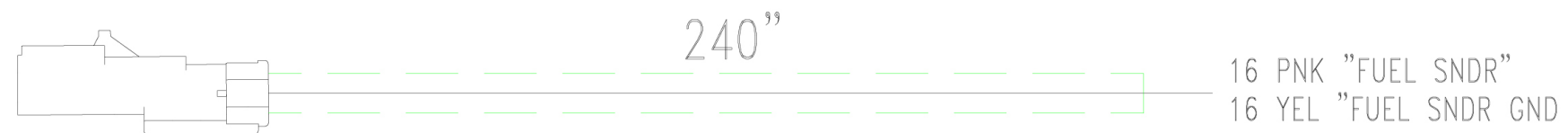

FS - "FUEL SENDER"

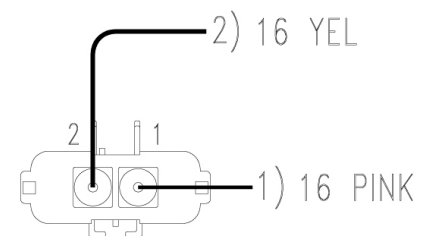

2WAY FCI 2.8MM MALE APEX BLACK
CONNECTOR (5420-0210)
CAVITY PLUG (5420-0005)

268 Super Sport

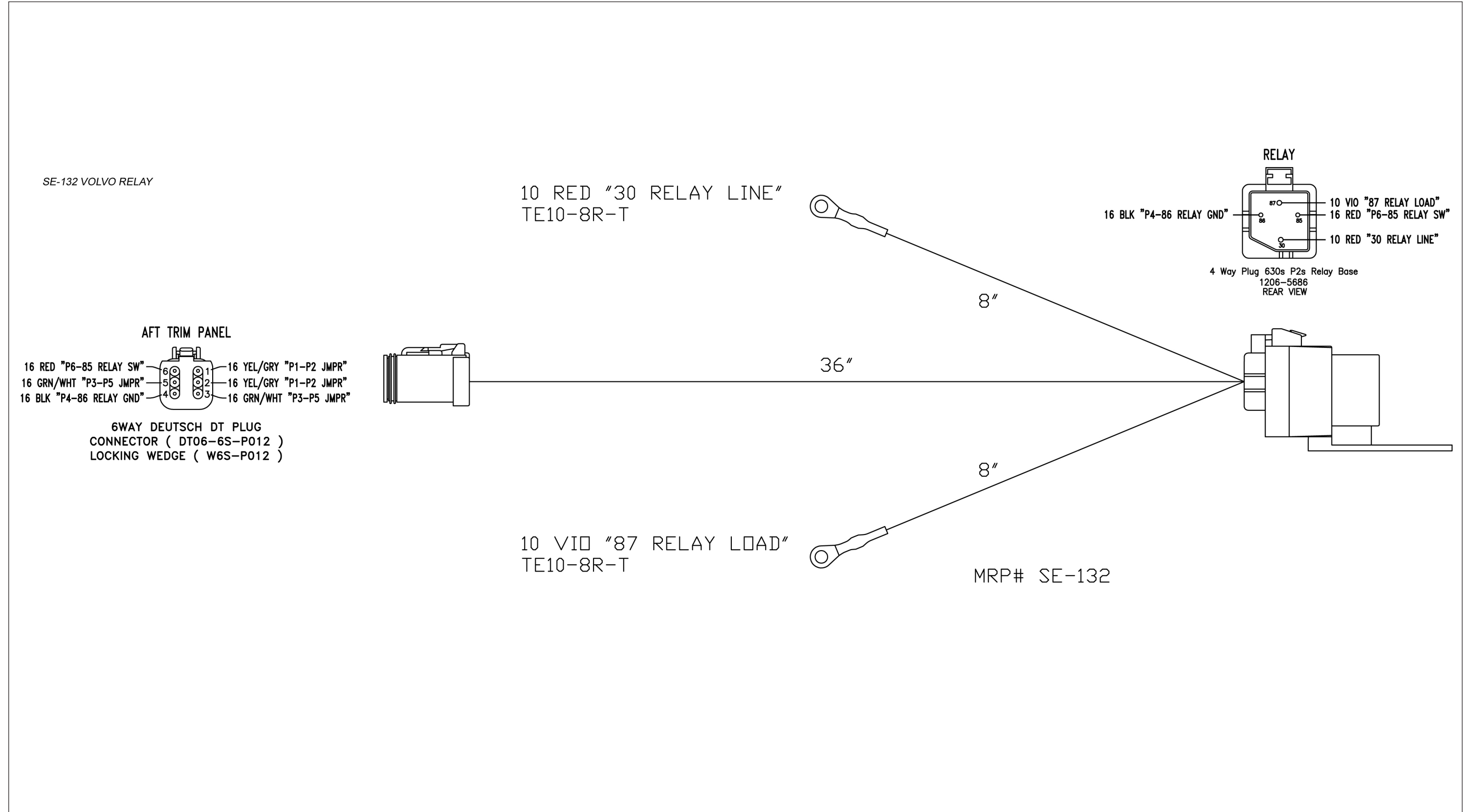

268 Super Sport

ON-OFF BATTERY SW PANEL

Use Black Flat Head Screws Only
Use ZZ-SE-135 for this panel wire assembly.

NO WIRES / LUGS ABOVE THE DASHED LINE

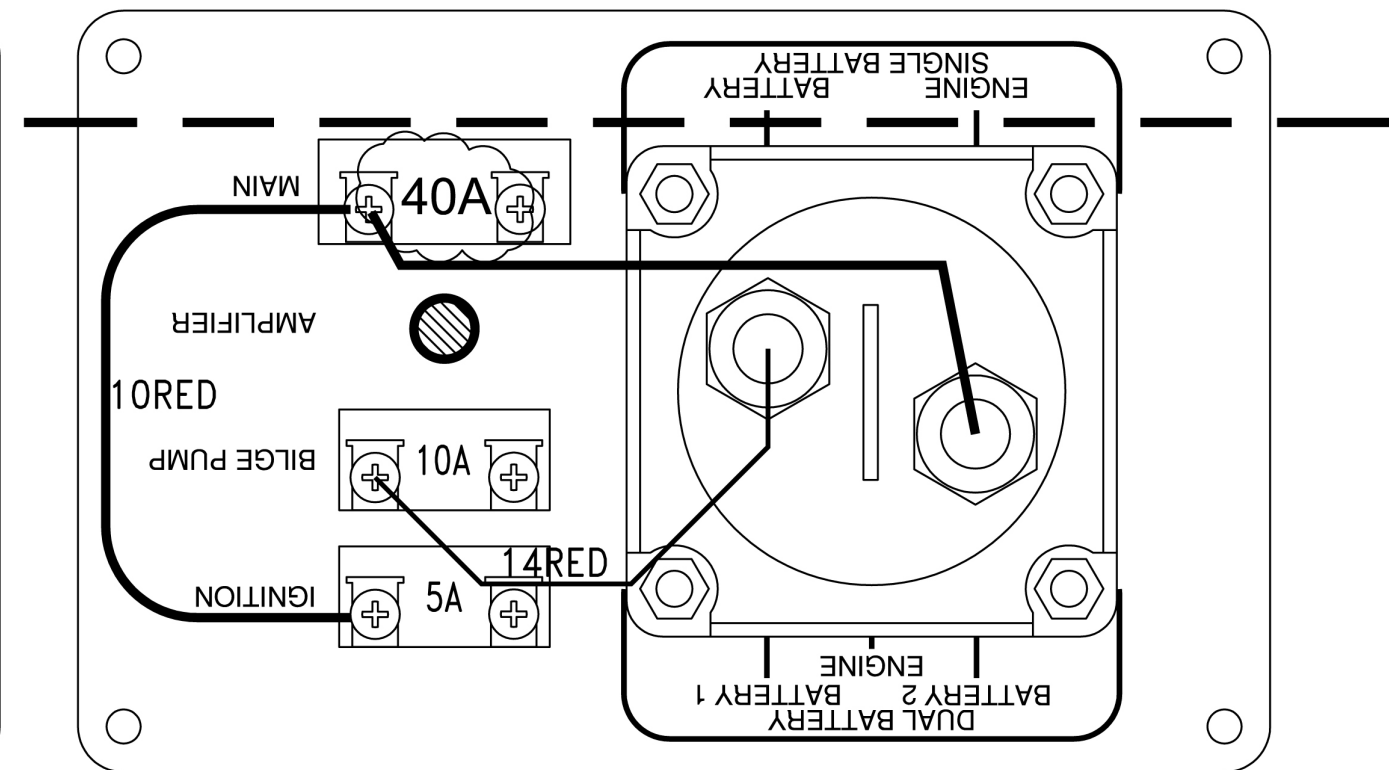
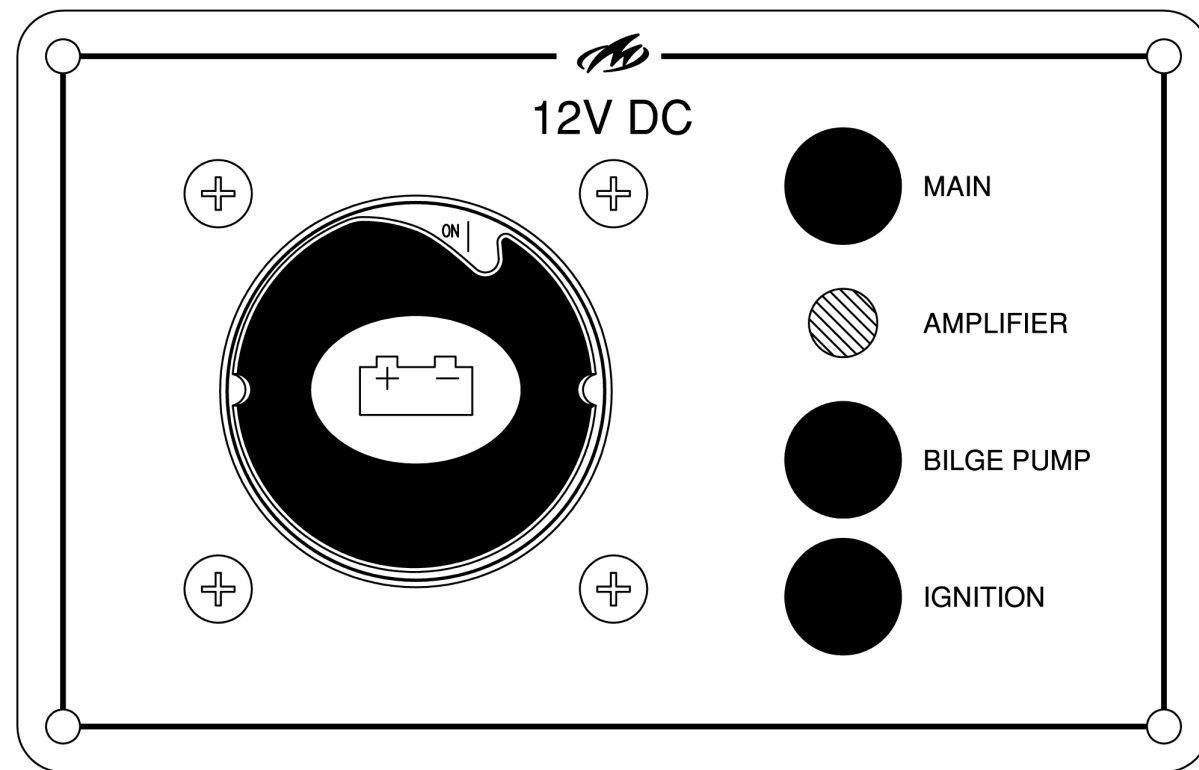

Ensure Breakers have screws installed

268 Super Sport

MERC AFT TRIM HARNESS

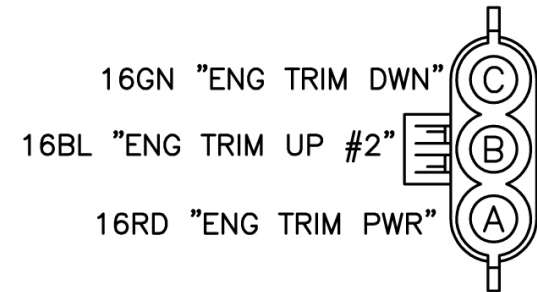

TRIM PLUG .150 FEMALE MP
CONN (12110293)
TPA (12052845)
TERM (12048074)
SEAL (15324973)

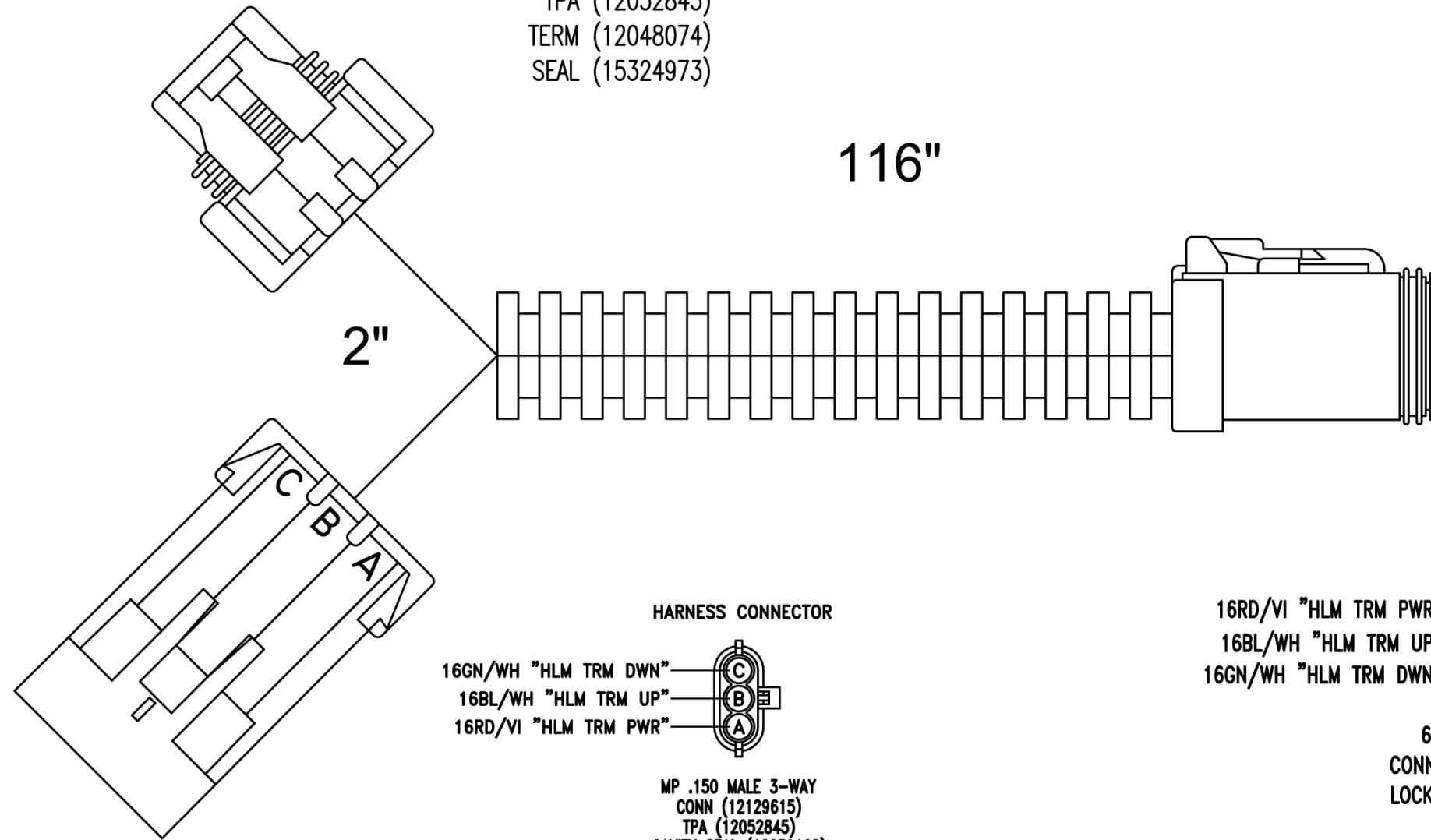

AFT TRIM PANEL

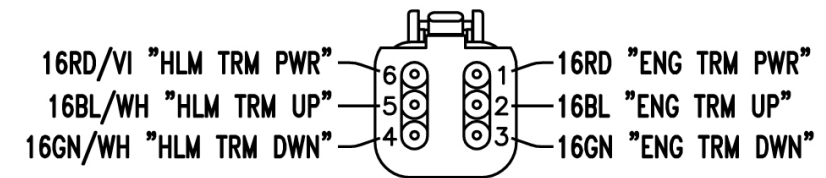

6WAY DEUTSCH DT PLUG
CONNECTOR (DT06-6S-P012)
LOCKING WEDGE (W6S-P012)

268 Super Sport

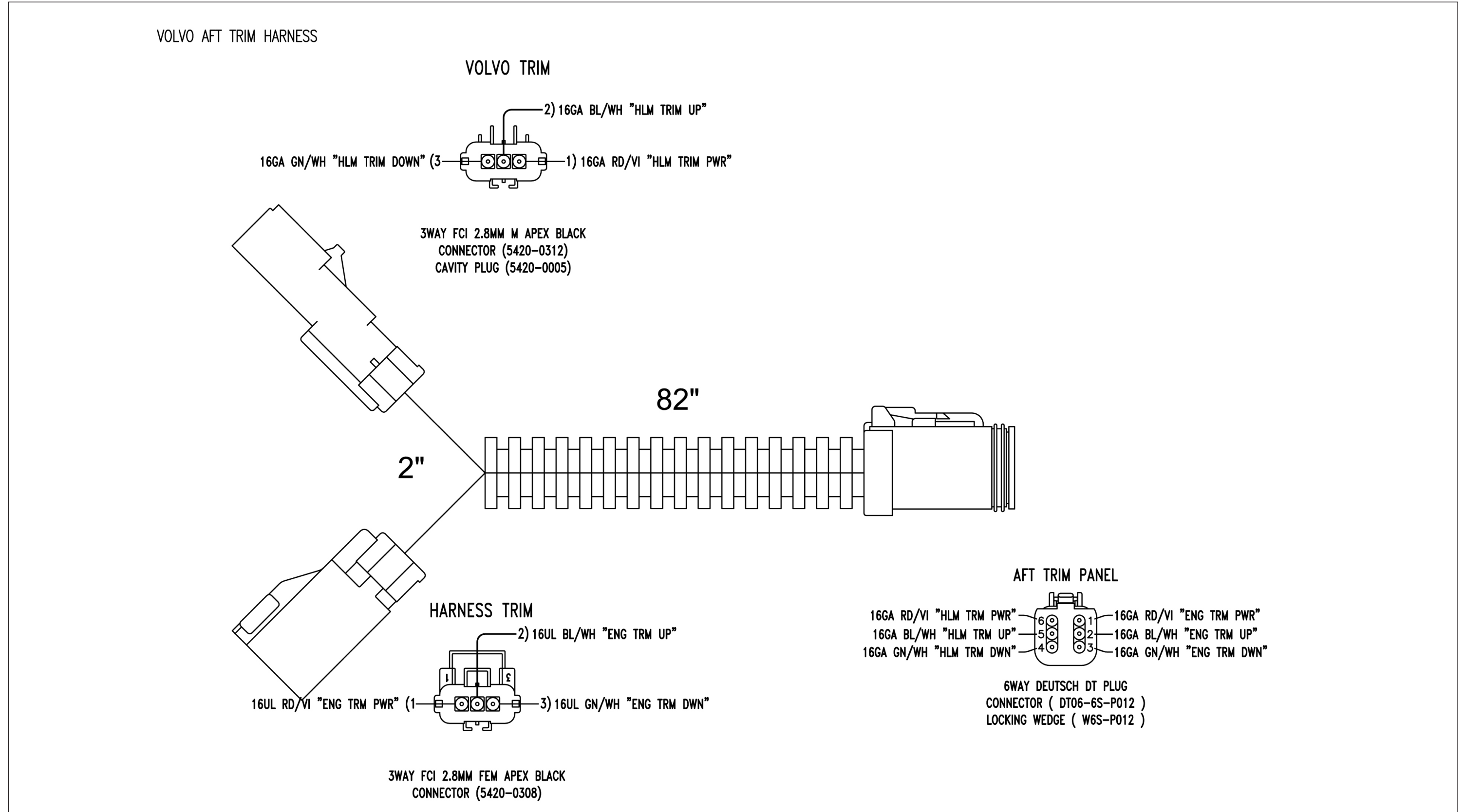

268 Super Sport

SE-202 MERC ENG HARNESS

NOTES:

1. USE ONLY WST WIRE ON ALL HARNESSES EXCEPT AC HARNESS. AC HARNESS ARE BOAT CABLE/UL ONLY.
2. USE ONLY HEAT SHRINK TERMINALS.
3. ALL SPLICES NEED TO BE HEATSHRINK TERMINALS.
4. HARNESS BREAKOUTS ARE ±1".
5. MARK CONNECTORS WITH THE PROPER LETTER OR NUMBER.

MONTEREY PLANT TO PROVIDE
LEAVE EMPTY - NO CAVITY PLUG
(TO SE-198) SW PANEL, "1 SW PWR" 14RD

14YL/RD "START"	2
---CAVITY PLUG---	3
14VI "RUN"	4
14VI "RUN PASS THRU"	5
---CAVITY PLUG---	6

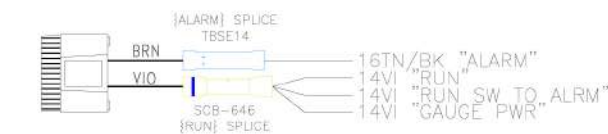

TRIP-80L-16G-ME

SPLICES - SEE ABOVE

3" TOTAL
BREAKOUT
LENGTH

KEY 6-POS DT PLUG
CONN (DT06-6S)
WEDGELOCK (W6S)
TERMS (1062-14-0122)
CAVITY PLUGS (114017)



GAUGES-4WAY DT RECEPT (PINS)
CONN (DT04-4P)
WEDGELOCK (W4P)

1	14VI "GAUGE PWR"
2	14YL "GAUGE GND"
3	16WH "CAN +" 16/2 1007
4	16BL "CAN -" TWISTED PAIR

HEATSHRINK
14VI "RUN PASS THRU"

14YL/RD "ENG TO NTRL SAFE"
.156 BULLET EPOXY MALE
14YL/RD "START"
.156FEM BULLET EPOXY FEMALE

14VI "ENG TO RUN SW"
.156 BULLET EPOXY MALE
14VI "RUN SW TO ALARM"
.156FEM BULLET EPOXY FEMALE

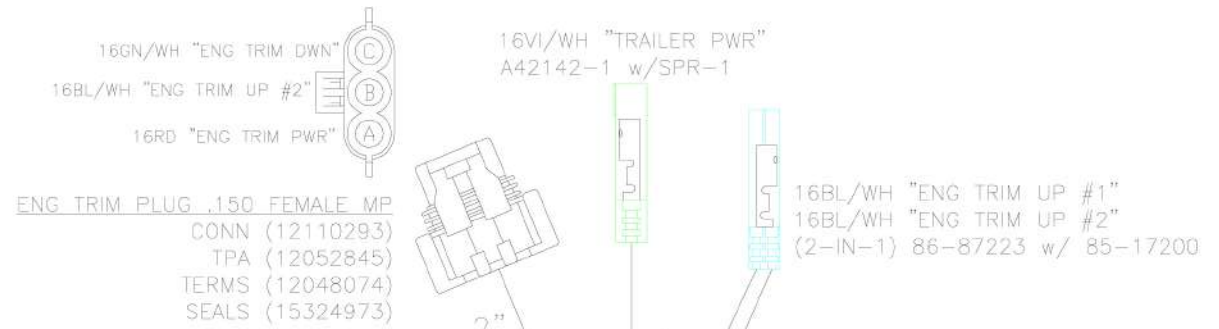

TRIM PLUG

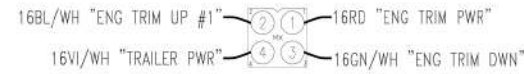

4-WAY MOLEX .093 PLUG
CONNECTOR (03-09-1049)
SOCKETS 14-20GA (02-09-1104)

A - 14-WAY DEUTSCH HDP
PLUG W/ PINS

A	-- CAVITY PLUG --
B	14YL "GAUGE GND"
C	14VI "ENG TO RUN SW"
D	-- CAVITY PLUG --
E	-- CAVITY PLUG --
F	16WH "CAN +" 16/2 1007
G	16BL "CAN -" TWISTED PAIR
H	-- CAVITY PLUG --
J	-- CAVITY PLUG --
K	-- CAVITY PLUG --
L	16TN/BK "ALARM"
M	-- CAVITY PLUG --
N	14YL/RD "ENG TO NTRL SAFE"
P	-- CAVITY PLUG --



CONN: HDP26-18-14PE-L017
TERMS: 1060-14-0122
CONNECTOR SHOWN FROM
WIRE-INSERTION SIDE

268 Super Sport

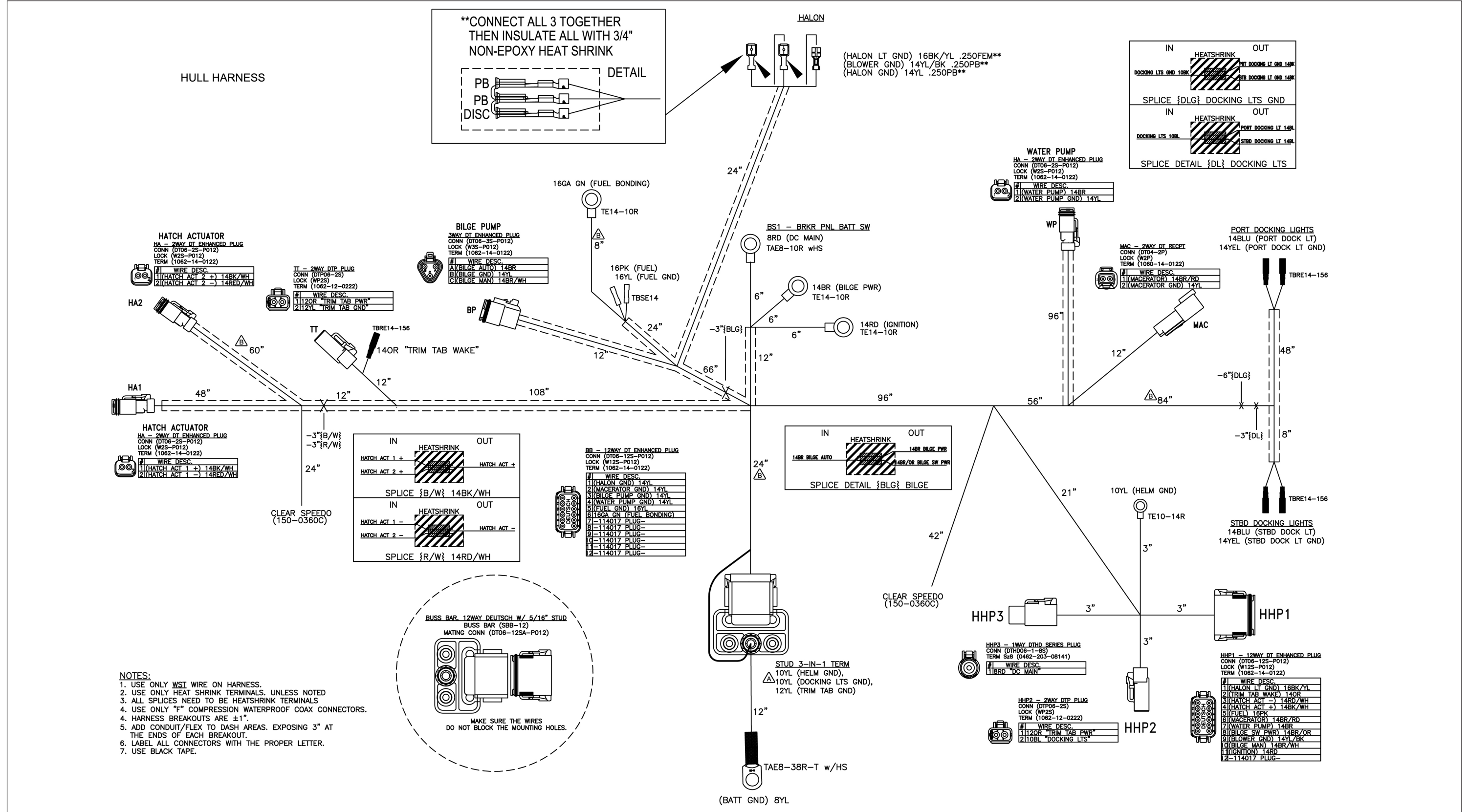

268 Super Sport

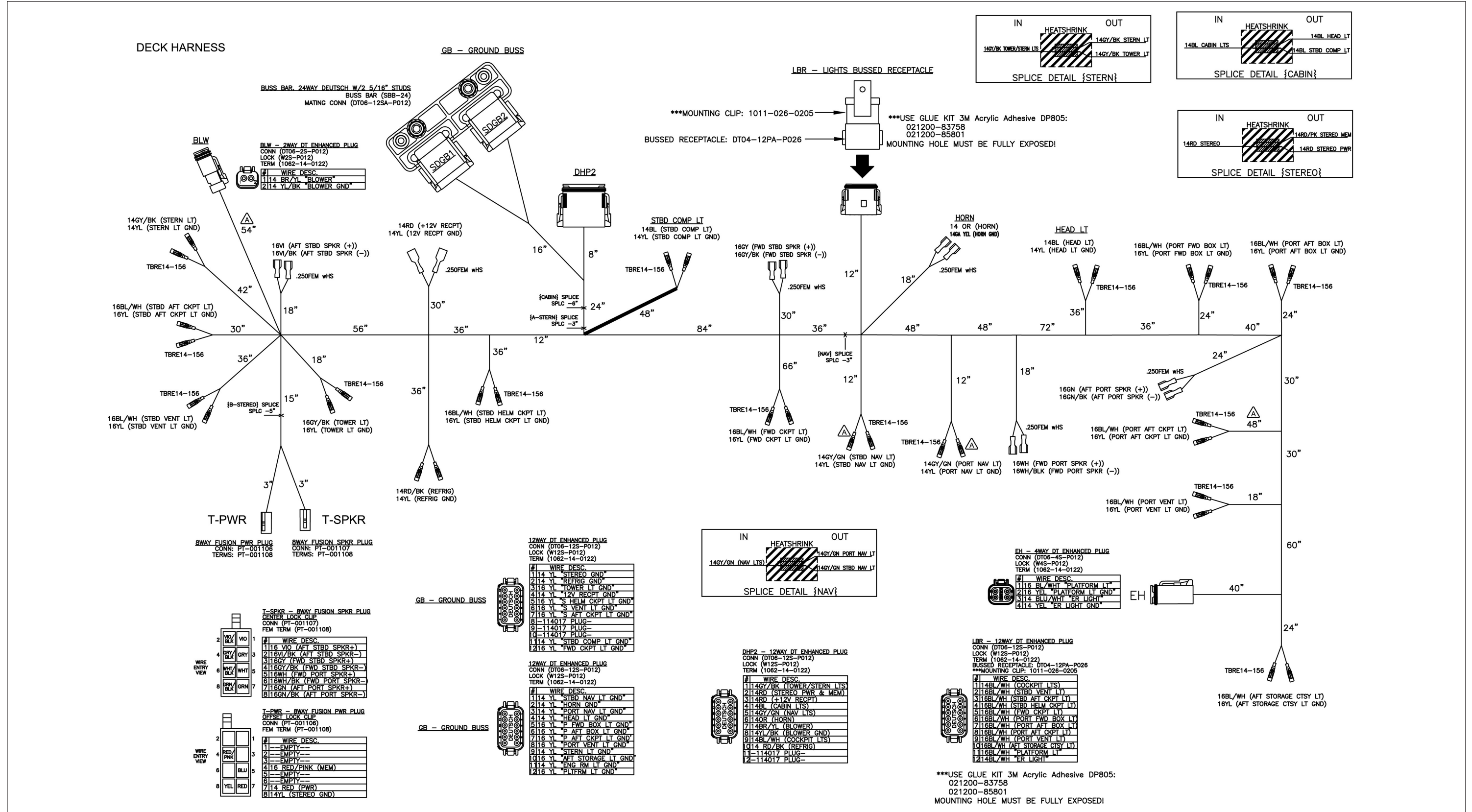

288 Super Sport

ARCH HARNESS

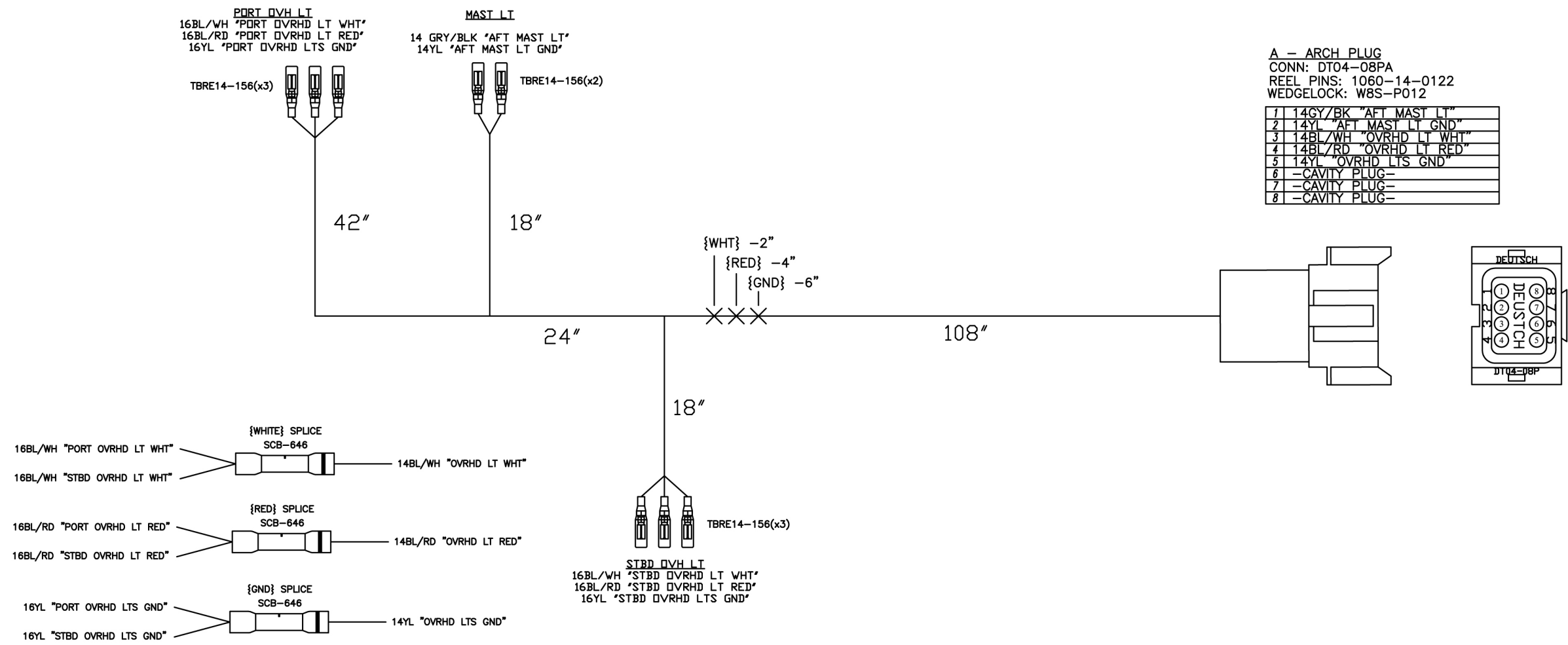

288 Super Sport

HATCH HARNESS

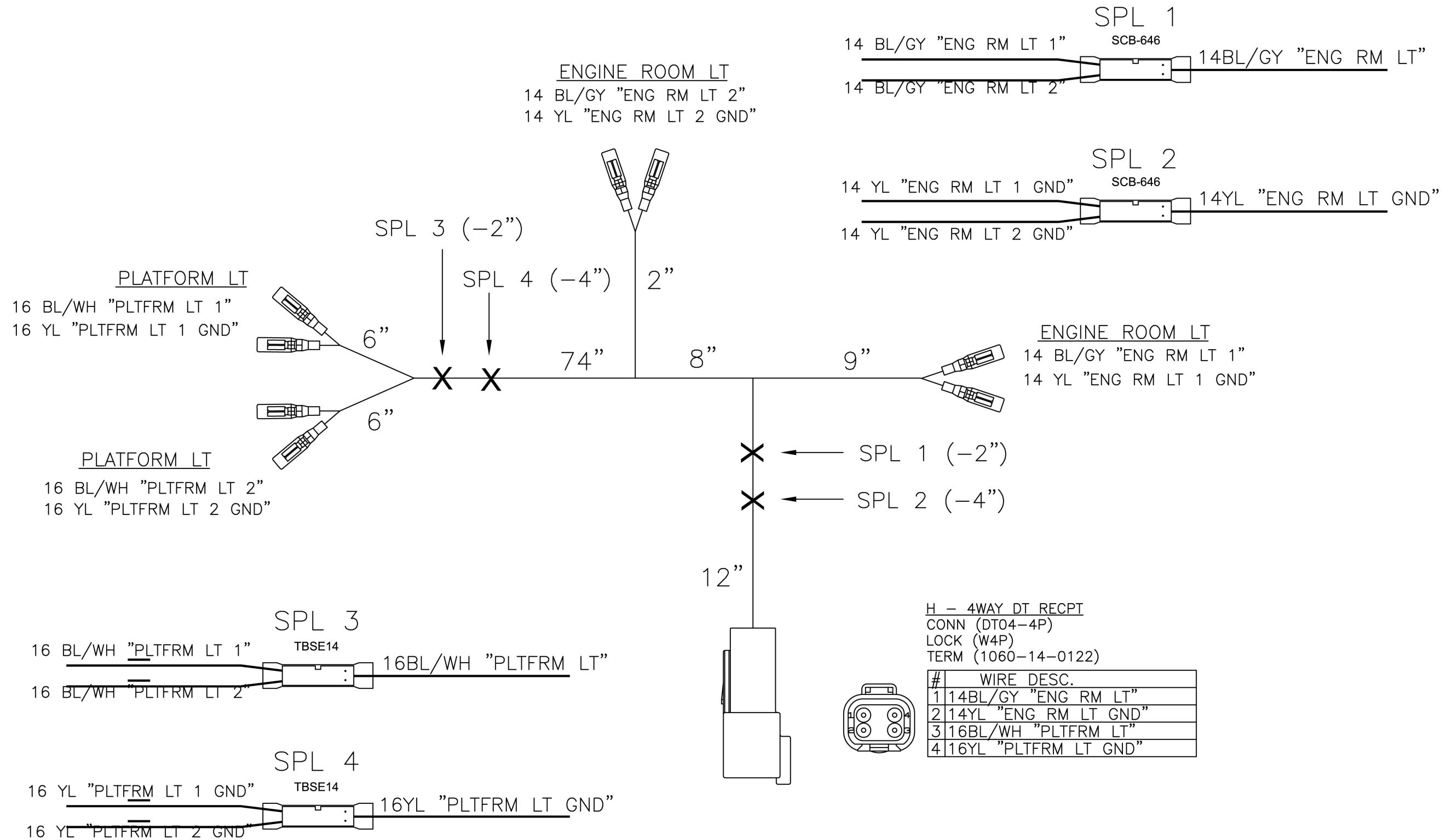

288 Super Sport

HULL HARNESS - CONNECTORS

EH1 - ELECTRIC HEAD
CONN: DEUTSCH DTHD06-1-8S
SOCKET: 0462-203-08141
1 18BR/OR "HEAD SYS(+)"

EH2 - ELEC HEAD SYS GND
DEUTSCH CONN: DTHD04-1-8P
PIN TERMINAL: 0460-204-08141
1 18YL "HEAD SYS(-)"

FBP - FWD BILGE PUMP
CONN: DT06-3S-P012
SOCKETS: 0462-209-16141
WEDGELOCK: W3S-P012
A 114BR "FWD BLG PMP FLOAT"
B 114YL "FWD BLG PMP GND"
C 114BR/WH "FWD BLG PMP SW"

H - HATCH
CONN: DT06-4S-P012
LOOSE SOCKETS: 0462-209-16141
WEDGELOCK: W4S-P012
1 114BL/GY "ENG ROOM LTS"
2 114YL "ENG ROOM LTS GND"
3 116BL/WH "PLATFORM LTS"
4 116YL "PLATFORM LTS GND"

HA - HELM ACC PANEL
CONN: DTP04-2P
SOCKETS: 1060-12-0222
WEDGELOCK: WP2P
1 110RD "HELM ACCY PANEL"
2 110YL "HELM ACCY PANEL GND"

HL - HATCH LIFTER
CONN: DT06-2S-P012
SOCKETS: 0462-209-16141
WEDGELOCK: W2S-P012
1 114BK/WH "HATCH DN"
2 114RD/WH "HATCH UP"

MAC - MACERATOR
CONN: DT06-2S-P012
SOCKETS: 0462-209-16141
WEDGELOCK: W2S-P012
1 114BR/RD "MACERATOR"
2 114YL "MACERATOR GND"

MUX - MUX INPUT
CONN: DEUTSCH HDP24-24-21PN
PINS, 10GA: 1060-12-0222
PINS, 12GA: 0460-204-12141
PINS, REEL, 16-14GA: 1060-14-0122
PINS, LOOSE, 16-14GA: 0460-215-16141
A. 16GY/GN "NAV LTS"
B. ---CAVITY PLUG---
C. 16BL/PK "UW LTS"
D. 12BR/YL "BLOWER"
E. 14OR "HORN"
F. 14GY/BK "MAST LTS"
G. 10BL/RD "DOCKING LTS"
H. 14RD/BK "EXHAUST(+)"
J. 14BL/WH "COCKPIT LTS"
K. 14BL/RD "OVRHD LT RED"
L. 14BL/WH "OVRHD LT WHT"
M. 14BL/GY "ENG ROOM LTS"
N. 16RD/YL "WINDLASS UP"
P. 16RD/GN "WINDLASS DOWN"
R. 14BR/WH "BILGE PMP SW"
S. 14BR/WH "FWD BLG PMP SW"
T. ---CAVITY PLUG---
U. 14RD/WH "HATCH UP"
V. 14BK/WH "HATCH DN"
W. 14BR/OR "BILGE PMP SWT(+)"
X. 14BR/OR "FWD BLG PMP SWT(+)"

A - ARCH PLUG
CONN: DT06-08SA-P012
REEL SOCKETS: 1062-14-0122
LOOSE SOCKETS: 0462-209-16141
WEDGELOCK: W8S-P012
1 14GY/BK "AFT MAST LT"
2 14YL "AFT MAST LT GND"
3 14BL/WH "OVRHD LT WHT"
4 14BL/RD "OVRHD LT RED"
5 14YL "OVRHD LTS GND"
6 ---CAVITY PLUG---
7 14OR/BL "ARCH UP"
8 14OR/GN "ARCH DOWN"

BL - BLOWER
CONN: DT06-2S-P012
REEL SOCKETS: 1062-14-0122
WEDGELOCK: W2S-P012
1 114BR/YL "BLOWER"
2 114YL/BK "BLOWER GND"

BP - BILGE PUMP
CONN: DT06-3S-P012
SOCKETS, LOOSE: 0462-209-16141
WEDGELOCK: W3S-P012
A 114BR "BILGE PMP FLOAT"
B 114YL "BILGE PMP GND"
C 114BR/WH "BILGE PMP SW"

BS1 - CONNECTS TO 288SS BATT SW, SE-192
DEUTSCH CONN: DTHD04-1-4P
PIN TERMINAL: 0460-204-0490
1 16RD "HELM MAIN - MUX PWR"

BS2
CONN: DTP04-4P
SOCKETS, 14 AWG: 1060-12-0166
SOCKETS, 10 AWG: 1060-12-0222
WEDGELOCK: WP4P
1 10OR "TRIM TABS PWR"
2 14OR/GN "ARCH DOWN"
3 14OR/BL "ARCH UP"
4 10RD "HELM ACCY PANEL"

BS3 - 12WAY DT ENHANCED RECEPT
CONN: DT04-12PA
PINS: 1060-14-0122 / 0460-215-16141
WEDGELOCK: W12P
WIRE DESC.
1 114RD "STEREO PWR (BS3)"
2 114BL "INTERIOR LTS PWR"
3 14RD "12V RECEPT PWR"
4 114BR/RD "MACERATOR(+)"
5 114BR/BL "WATER PUMP"
6 114BR/BK "SUMP PUMP"
7 114BR/OR "BILGE PMP SWT(+)"
8 114BR "BILGE PMP FLOAT"
9 114BR/OR "FWD BLG PMP SWT(+)"
10 14RD/BK "IGNITION"
11 114BR "FWD BLG PMP FLOAT"
12 14RD/BL "CKPT DC FRIDGE"

BS4 - ELEC HEAD SYS GND
DEUTSCH CONN: DTHD04-1-8P
PIN TERMINAL: 0460-204-08141
1 11UL 8BR/OR "HEAD SYS(+)"

SD1 - STBD DECK CONNECTOR
CONN: DT04-12PA
PINS: 1080-14-0122 / 0460-215-16141
WEDGELOCK: W12P
1 16WH "FWD PORT SPKR(+)"
2 16WH/BK "FWD PORT SPKR(-)"
3 16GRAY "FWD STBD SPKR(+)"
4 16GY/BK "FWD STBD SPKR(-)"
5 16V "AFT STBD SPKR(+)"
6 16V/BK "AFT STBD SPKR(-)"
7 16GN "AFT PORT SPKR (+)"
8 16GN/BK "AFT PORT SPKR(-)"
9 14RD "12V RECEPT PWR"
10 14RD/BL "CKPT DC FRIDGE"
11 16BL/WH "CKPT LTS (SD1)"
12 14BL "HEAD LT"

SD2 - STBD DECK CONNECTOR
CONN: DT04-2P
PINS: 1060-14-0122 / 0460-215-16141
WEDGELOCK: W2P
1 14BL "STBD COMPART LT"
2 16GY/GN "NAV LTS"

SP - SUMP PUMP
CONN: DT06-2S-P012
SOCKETS: 0462-209-16141
WEDGELOCK: W2S-P012
1 114BR/BK "SUMP PMP"
2 114YL "SUMP PMP GND"

T-SPKR, 8WAY FUSION SPKR PLUG
CONN: PT-001107
TERMS: PT-001108
T-SPKR - CONN # PT-001107
POS WIRE
1 16V "AFT STBD SPKR(+)"
2 16V/BK "AFT STBD SPKR(-)"
3 16GRAY "FWD STBD SPKR(+)"
4 16GY/BK "FWD STBD SPKR(-)"
5 16WH "FWD PORT SPKR(+)"
6 16WH/BK "FWD PORT SPKR(-)"
7 16GN "AFT PORT SPKR(+)"
8 16GN/BK "AFT PORT SPKR(-)"

T-PWR, 8WAY FUSION PWR PLUG
CONN: PT-001108
TERMS: PT-001108
T-PWR - CONN # PT-001108
POS WIRE
1 --EMPTY--
2 --EMPTY--
3 --EMPTY--
4 14 RD/PK "STEREO MEM"
5 --EMPTY--
6 --EMPTY--
7 14 RD/BK "STEREO PWR"
8 14YL "STEREO GND"

TB
E30TB3
14RD/BK "IGNITION"
16OR "TRIM TABS WAKE-UP"
16V "FIREBOY LT PWR"
14YL "TB GROUND"

TT - TRIM TABS
CONN: DTP06-2S
SOCKETS: 1062-12-0222
WEDGELOCK: WP2S
1 110OR "TRIM TABS PWR"
2 110YL "TRIM TABS GND"

WF1, 2-WAY DEUTSCH PLUG
CONN - DT06-2S-P012
WEDGELOCK - W2S-P012
WIRE DESCRIPTION
1 14BK/WH "WASTE FULL (POS1)"
2 14BK "WASTE FULL (POS2)"

WF2, 2-WAY DEUTSCH RECEPT
CONN - DT04-2P
WEDGELOCK - W2P
WIRE DESCRIPTION
1 14BK/WH "WASTE FULL (POS1)"
2 14BK "WASTE FULL (POS2)"

WM1, 2-WAY DEUTSCH RECEPT
CONN - DT04-2P
WEDGELOCK - W2P
WIRE DESCRIPTION
1 14BK/YL "WASTE MID (POS1)"
2 14BK/RD "WASTE MID (POS2)"

WM2, 2-WAY DEUTSCH PLUG
CONN - DT06-2S-P012
WEDGELOCK - W2S-P012
WIRE DESCRIPTION
1 14BK/YL "WASTE MID (POS1)"
2 14BK/RD "WASTE MID (POS2)"

WP - WATER PUMP
CONN: DEUTSCH DT06-2S-P012
SOCKETS: 0462-209-16141
WEDGELOCK: W2S-P012
1 114BR "WATER PUMP"
2 114YL "WATER PUMP GND"

BSP - BOW SWITCH PWR
PACKARD FUSEHOLDER
HOUSING: 12085030
COVER: 12033731
FUZE: EATC5
TERMINALS: 12066614-T
LABEL: L-011 "5 AMP"
14RD "BOW SW PWR (B)"
14RD "BOW SW PWR (A)"

FGB - FWD GROUND BUSS
SBB-12 w/
DT06-12SA-P012
6YL "MUX GND"
8YL "HEAD SYS(-)"
10YL "DECK TO HULL GND"
MAKE SURE THE WIRES DO NOT BLOCK THE MOUNTING HOLES.

FGB - 12WAY DT ENHANCED PLUG
CONN: DT06-12S-P012
WEDGELOCK: W12S-P012
TERMS: 1062-14-0122
WIRE DESC.
1 114YL "FWD BLG PMP GND"
2 114YL "SUMP PMP GND"
3 114YL "MACERATOR GND"
4 114YL "WATER PUMP GND"
5 114YL "HORN GND"
6 114YL "PORT DOCKING LT GND"
7 114YL "STBD DOCKING LT GND"
8 116YL "COMPASS LT GND"
9 114YL "TB GROUND"
10 114017 PLUG-
11 114017 PLUG-
12 114017 PLUG-

SGR - 12WAY DT ENHANCED PLUG
CONN: DT06-12S-P012
WEDGELOCK: W12S-P012
TERMS: 1062-14-0122
WIRE DESC.
1 116YL "PLATFORM LTS GND"
2 114YL "ENG ROOM LTS GND"
3 116YL "UW LTS GND"
4 114YL "EXHAUST GND"
5 116YL "SKI LOCKER LT GND"
6 114YL "STEREO GND"
7 116YL "STERN LT GND"
8 114YL "OVRHD LTS GND"
9 114YL "AFT MAST LT GND"
10 114YL "BILGE PMP GND"
11 116GN "FUEL TANK BOND"
12 116YL "FUEL GND"

288 Super Sport

DECK HARNESS

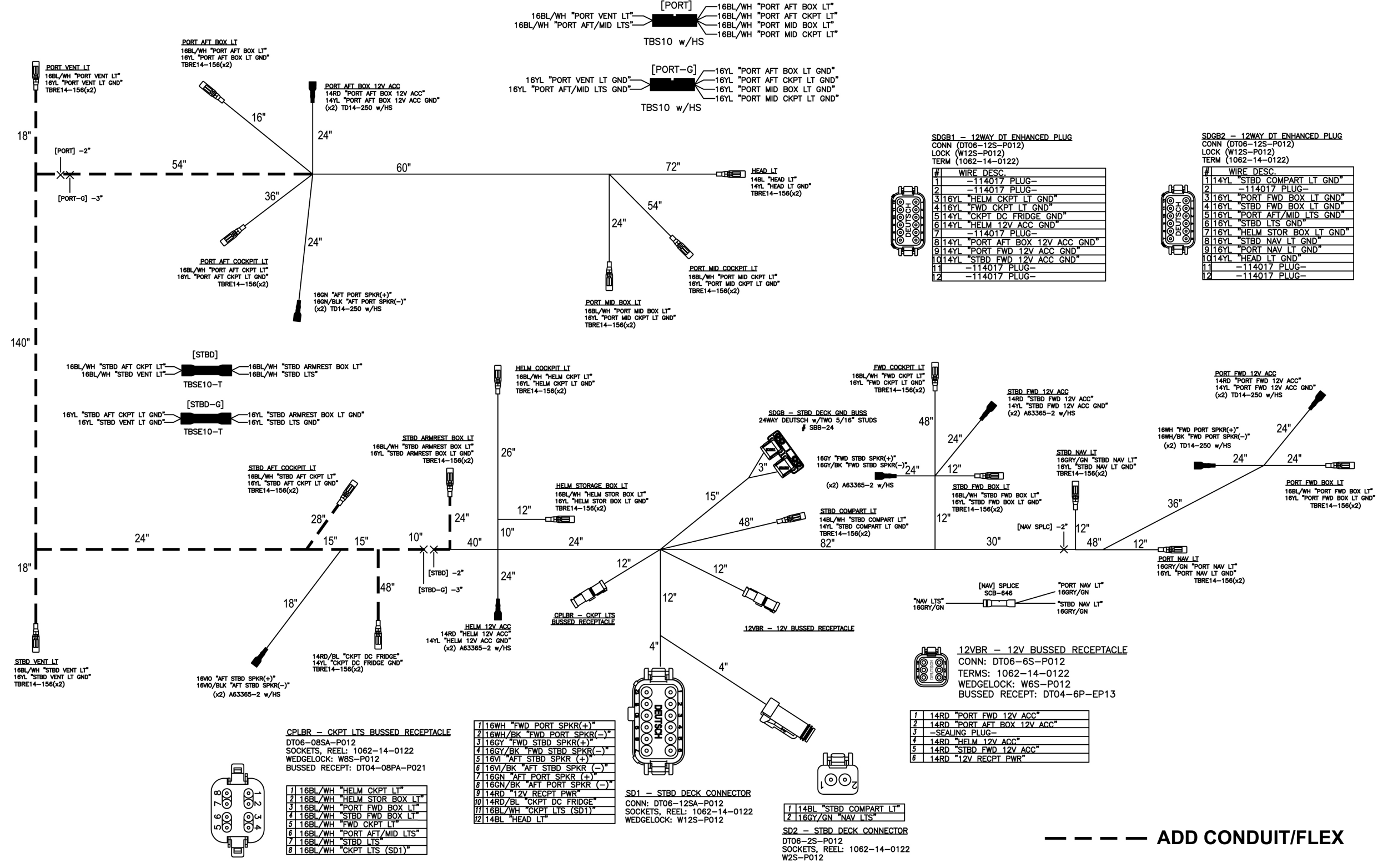

328 Super Sport

220V AC ELECTRICAL PANEL

PANEL QC

TEST PROCEDURE

-BLACK WIRE(SHORE HOT) TO WHITE WIRE(SHORE NTRL), LIGHT SHOULD ILLUMINATE TO SHOW REVERSED POLARITY. WITHOUT PRESSING THE SWITCH BUTTON.

-BLACK WIRE(SHORE HOT) TO BLACK WIRE(SHORE HOT), LIGHT ILLUMINATES ONLY WHEN THE TOP OF THE SWITCH IS DEPRESSED SHOWING THAT THE WIRING IS CORRECT. (NO REVERSE POLARITY)

NOTES

1. MAKE SURE PANEL SCREEN IS "220 VOLTS AC 50 Hz"
2. USE ONLY UL WIRE ON PANEL.
3. USE ONLY HEAT SHRINK TERMINALS.
4. PANEL MATERIAL IS .090 ALUMINUM
5. WARNING SCREEN IS ORANGE AND TEXT AND OUTLINES ARE WHITE SCREEN.
6. USE #6 BLACK SCREWS TO MOUNT HARDWARE.
7. DISCARD ALL ORIGINAL BREAKER SCREWS AND USE SS 10X32X3/8 SCREWS WITH #10 WASHERS.
8. USE 0.75" BUSS ON CENTER FOR BREAKER LINKS.
9. USE DREMEL TO TAKE OFF PAINT FOR GROUNDING WIRE.

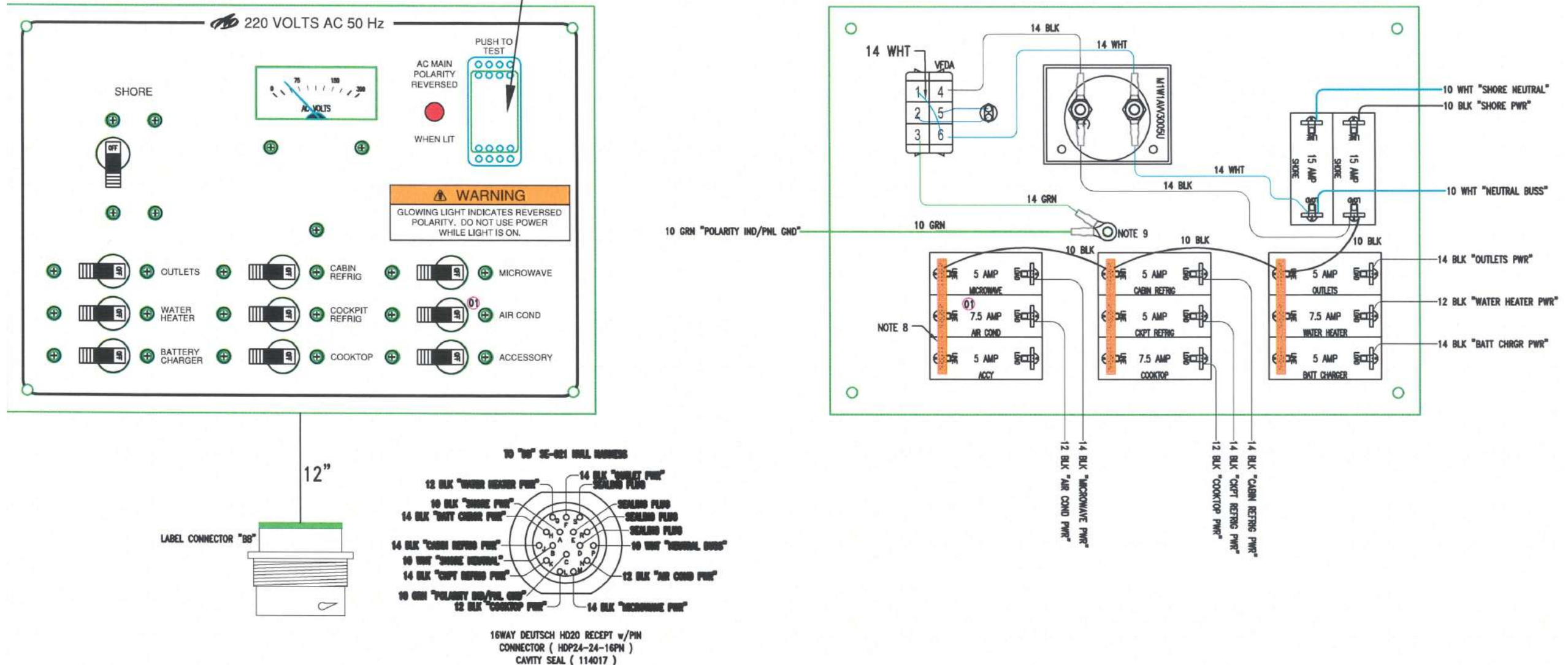

328 Super Sport

AC ELECTRICAL PANEL

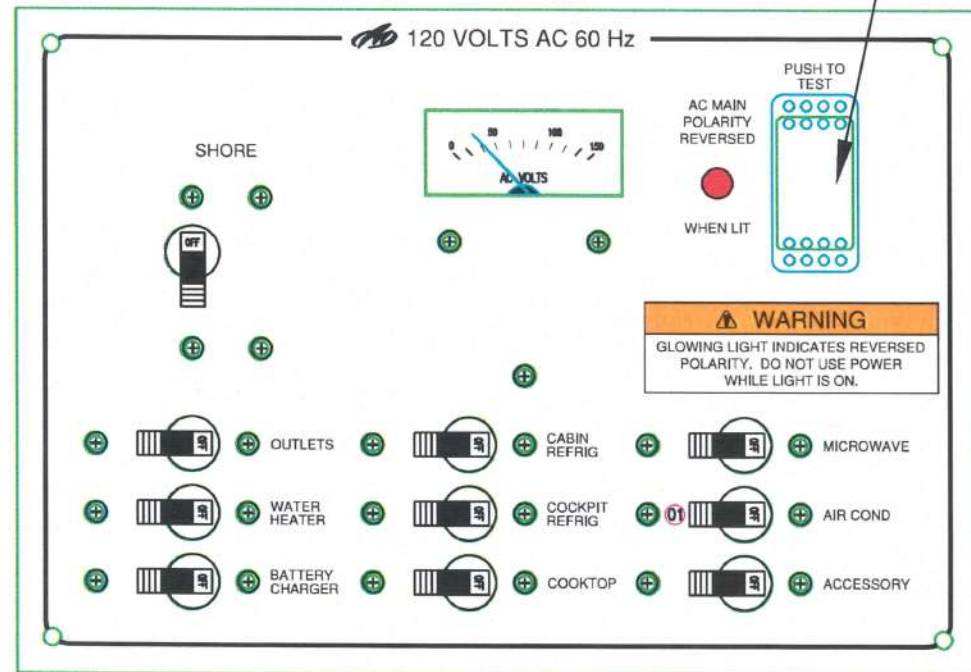

PANEL QC TEST PROCEDURE

-BLACK WIRE(SHORE HOT) TO WHITE WIRE(SHORE NTRL), LIGHT SHOULD ILLUMINATE TO SHOW REVERSED POLARITY. WITHOUT PRESSING THE SWITCH BUTTON.

-BLACK WIRE(SHORE HOT) TO BLACK WIRE(SHORE HOT), LIGHT ILLUMINATES ONLY WHEN THE TOP OF THE SWITCH IS DEPRESSED SHOWING THAT THE WIRING IS CORRECT. (NO REVERSE POLARITY)

NOTES

1. MAKE SURE PANEL SCREEN IS "120 VOLTS AC 60 Hz"
2. USE ONLY UL WIRE ON PANEL.
3. USE ONLY HEAT SHRINK TERMINALS.
4. PANEL MATERIAL IS .090 ALUMINUM
5. WARNING SCREEN IS ORANGE AND TEXT AND OUTLINES ARE WHITE SCREEN.
6. USE #6 BLACK SCREWS TO MOUNT HARDWARE.
7. DISCARD ALL ORIGINAL BREAKER SCREWS AND USE SS 10X32X3/8 SCREWS WITH #10 WASHERS.
8. USE 0.75" BUSS ON CENTER FOR BREAKER LINKS.
9. USE DREMEL TO TAKE OFF PAINT FOR GROUNDING WIRE.

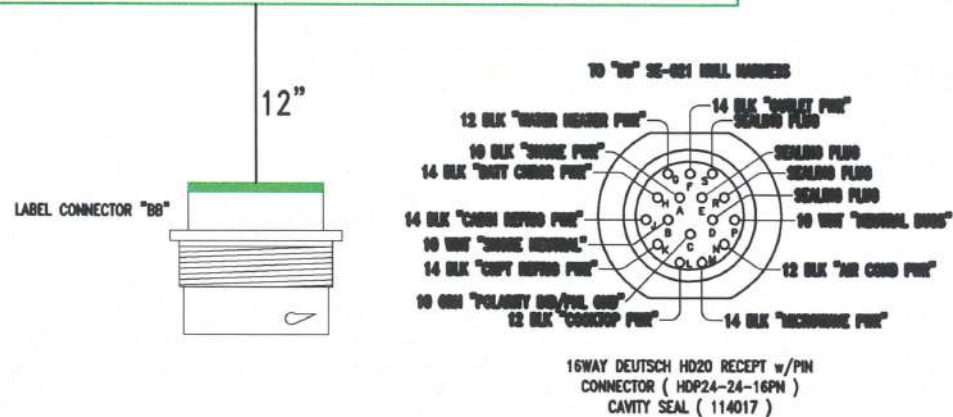
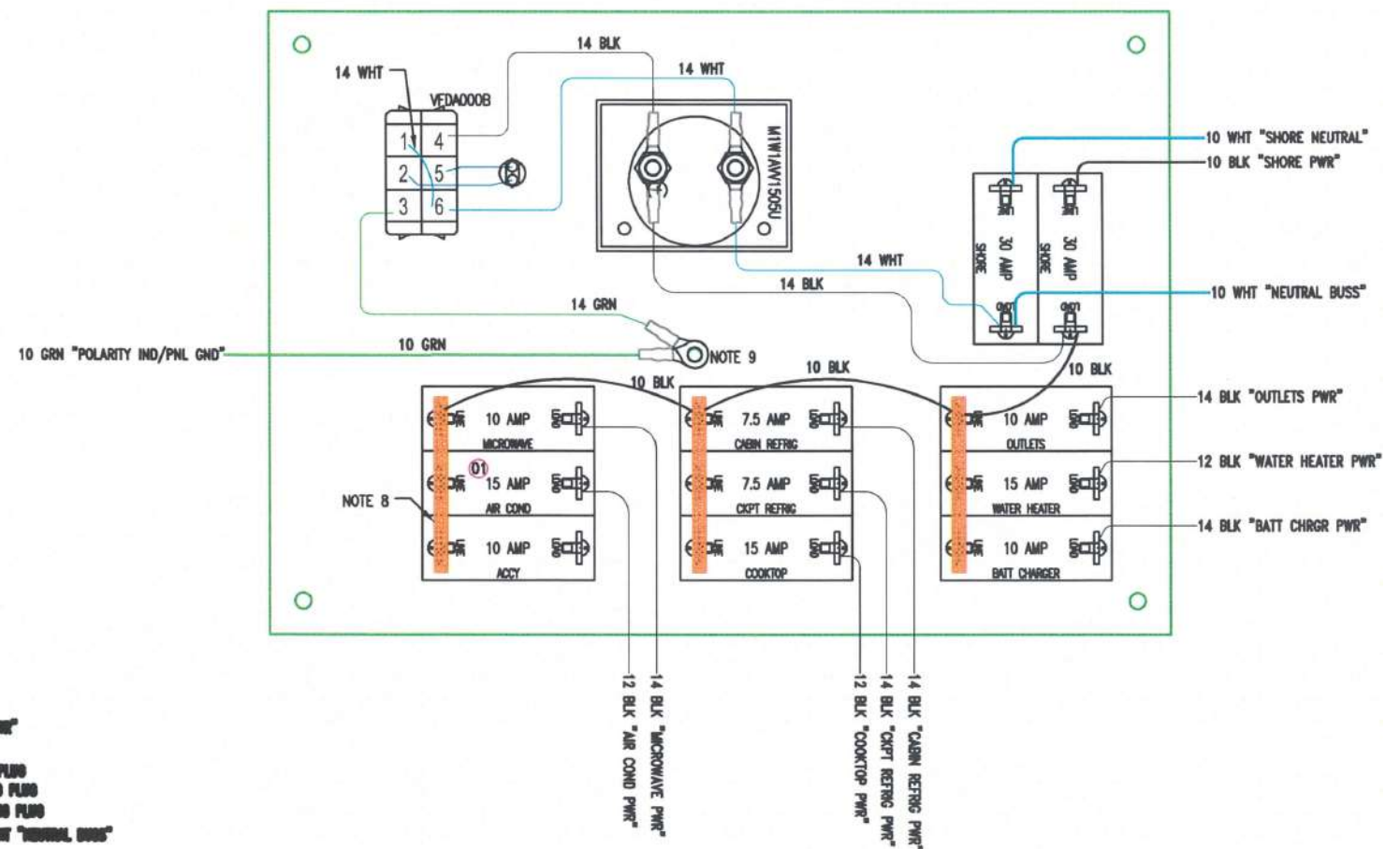

328 Super Sport

AC BUSS BARS

AC GROUND BUSS

EBB2-10

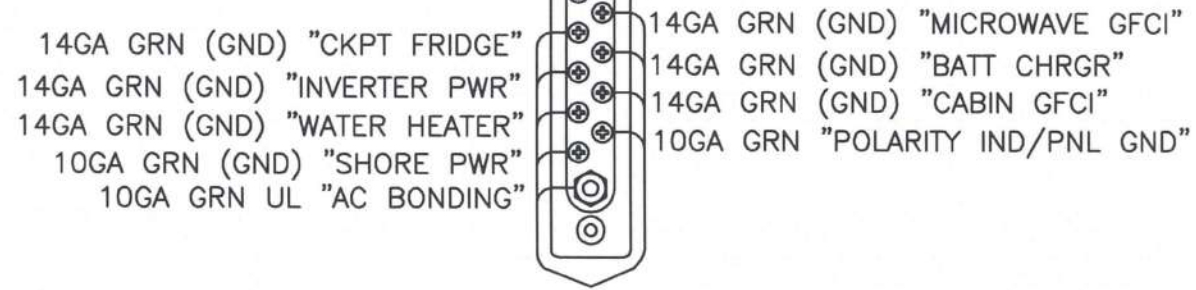

NEUTRAL BUSS

EBB2-10

EBB2-10C

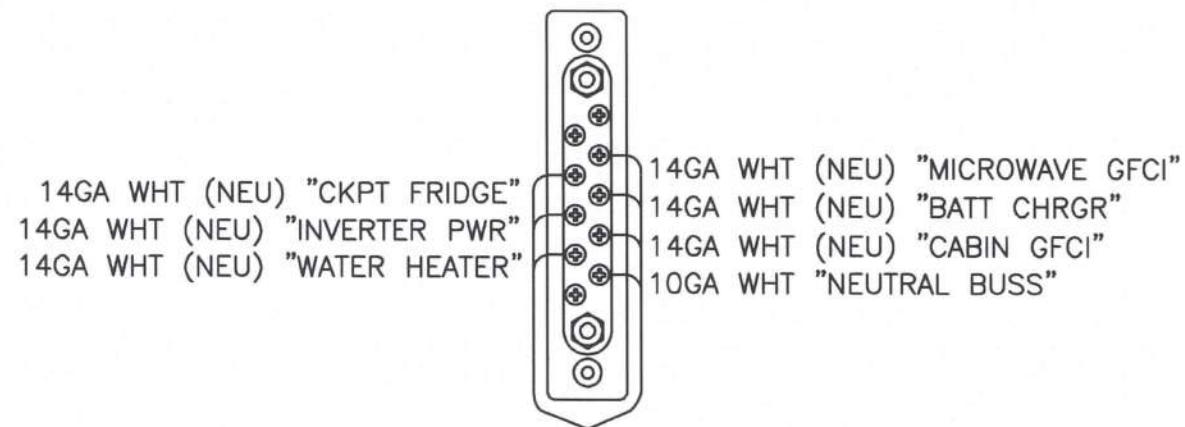

NOTES (ENTIRE HARNESS):

1. CABIN LTS 1, 2, & 3 ARE SAME CIRCUIT.
2. CHECK GFCI PLUGS FOR CORRECT LINE AND LOAD "PINS VS SOCKETS".
3. HELM GROUND BUSS IS 6 OR 10 WAY BLUE SEAS TYPE.
4. CHECK RING SIZE ON DC GROUND BUSS TO AC GROUND BUSS TO MAKE SURE IT FITS BUSS POST.

328 Super Sport

DC BUSS BARS

PGB – PORT GROUND BUSS

EBB2-10

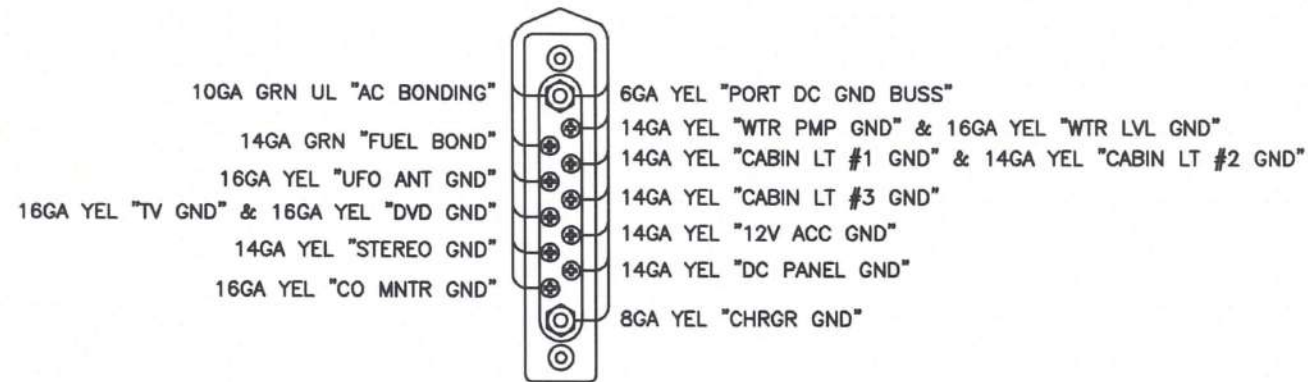

SGB – STBD GROUND BUSS

EBB2-10

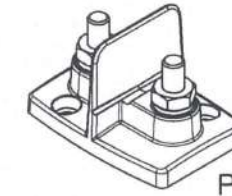
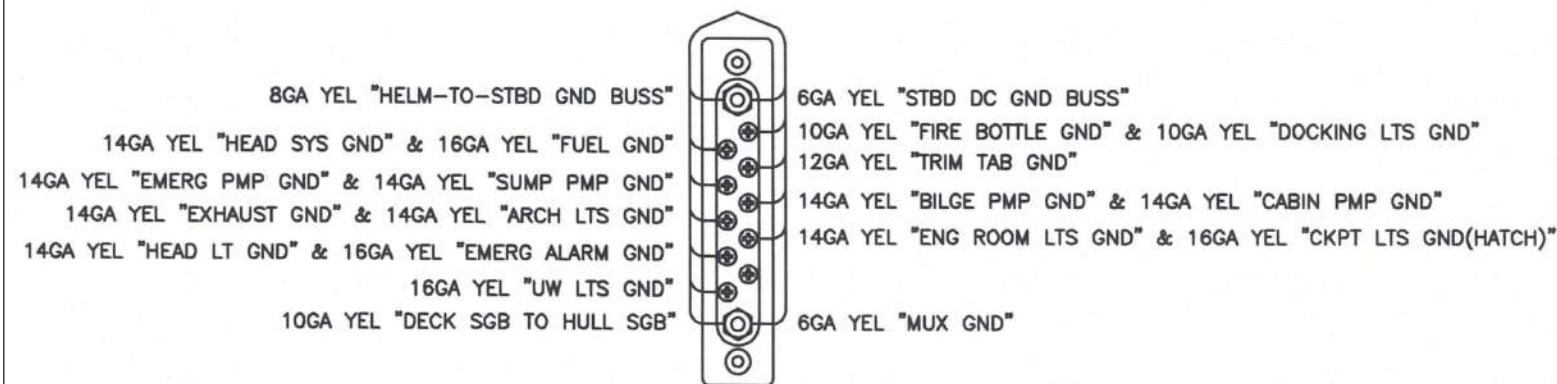

BLUE SEA
PACER # 2016 (WITH COVER)

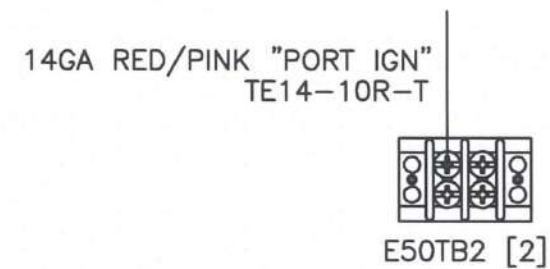
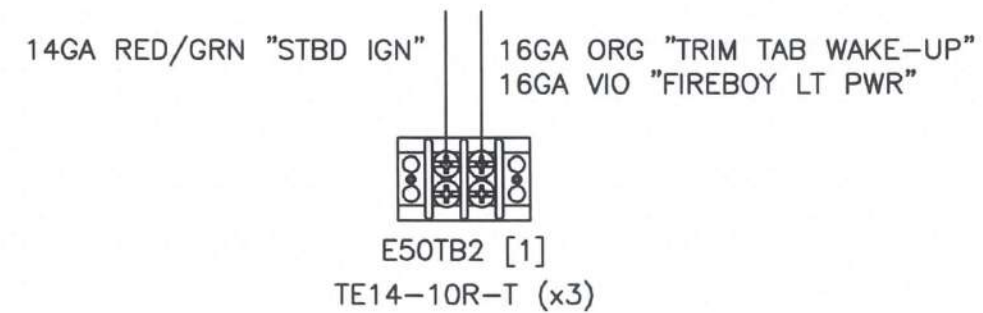
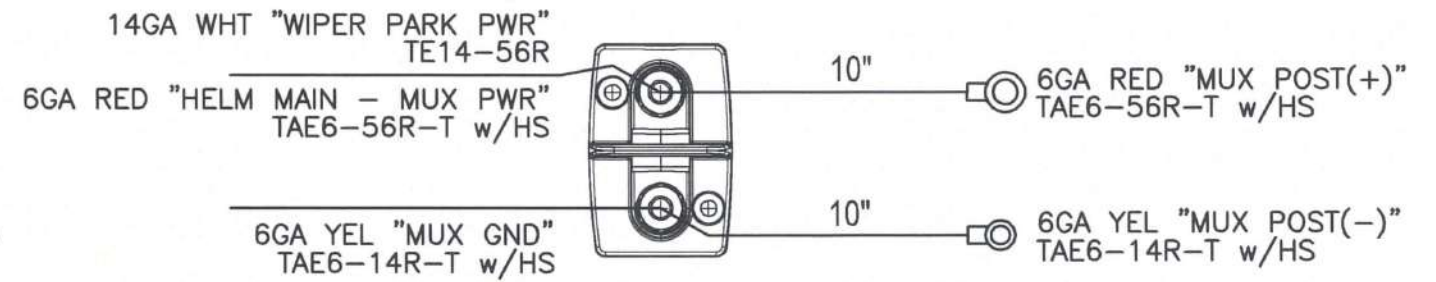

328 Super Sport

DECK BUSS BARS

PDGB – PORT DECK GND BUSS

EBB2-10

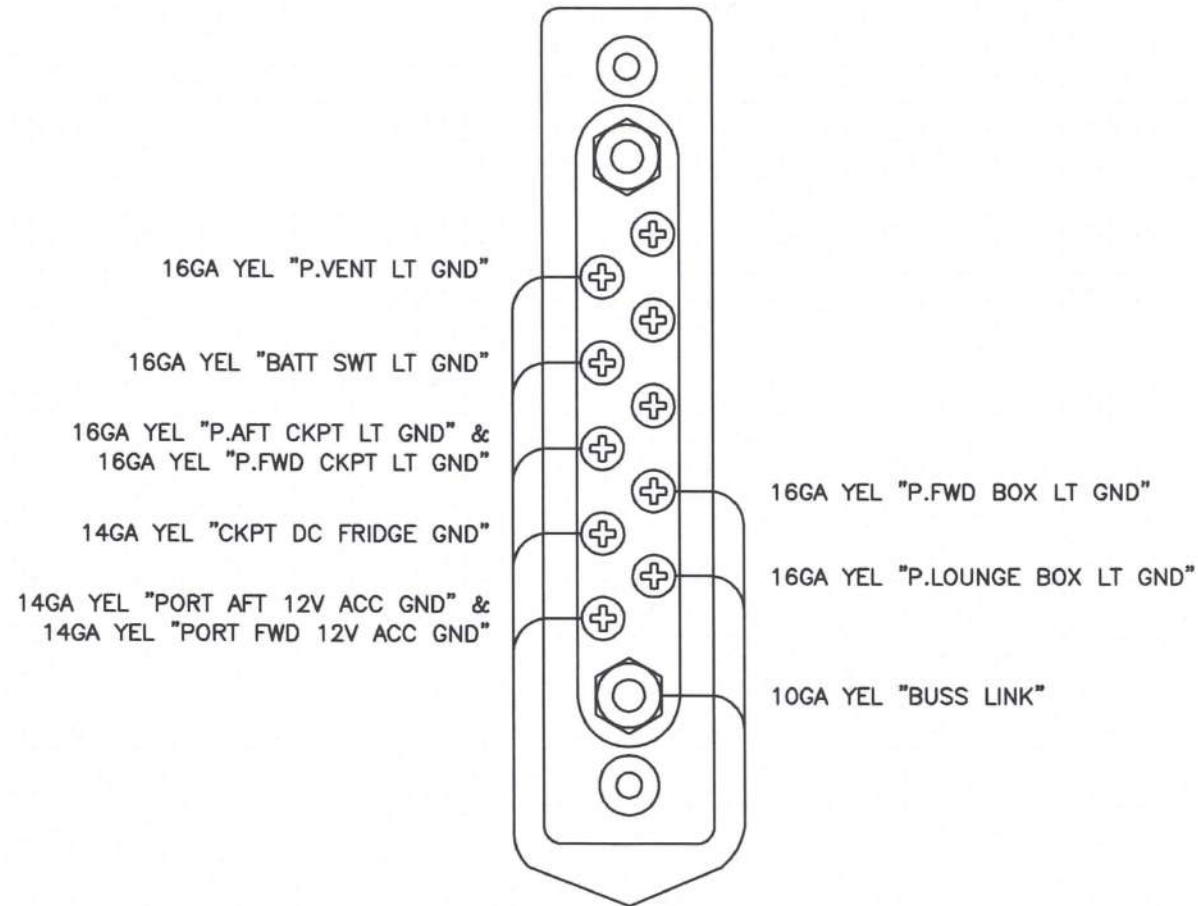

SDGB – STBD DECK GND BUSS

EBB2-10

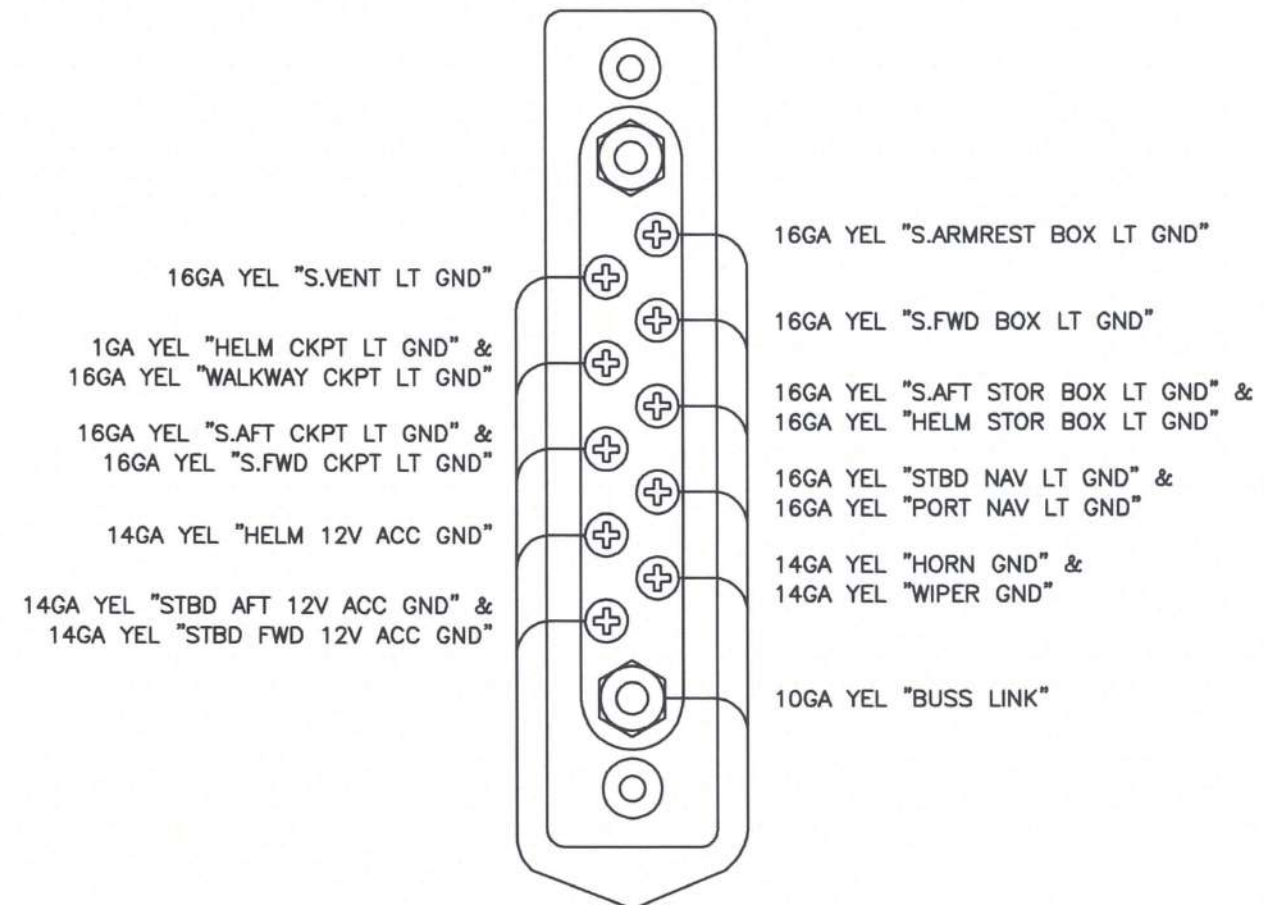

328 Super Sport

DECK HARNESS CONNECTORS

12VBR - 12V RECEPT BUSSED RECEPTACLE

CONN: DT06-6S-P012
 SOCKETS, REEL: 1062-14-0122
 WEDGELOCK: W6S-P012
 BUSSED RECEPTACLE: DT04-6P-EP13
 ***MOUNTING CLIP: 1011-026-0205

1	14GA RED	"PORT FWD 12V ACC"
2	14GA RED	"PORT AFT 12V ACC"
3	14GA RED	"STBD AFT 12V ACC"
4	14GA RED	"HELM 12V ACC"
5	14GA RED	"STBD FWD 12V ACC"
6	14GA RED	"12V ACC DECK PWR"

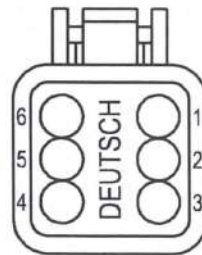

PCPLBR - PORT CKPT LTS BUSSED RECEPTACLE

CONN: DT06-08SA-P012
 REEL SOCKETS: 1062-14-0122
 WEDGELOCK: W8S-P012
 BUSSED RECEPTACLE: DT04-08PA-P021
 ***MOUNTING CLIP: 1011-027-0805

1	16GA BLU/WHT	"CKPT LTS LINK"
2	16GA BLU/WHT	"BATT SWT LT"
3	16GA BLU/WHT	"P.AFT CKPT LT"
4	16GA BLU/WHT	"P.FWD BOX LT"
5	16GA BLU/WHT	"P.FWD CKPT LT"
6	16GA BLU/WHT	"P.LOUNGE BOX LT"
7	16GA BLU/WHT	"P.VENT LT"
8	---	CAVITY PLUG---

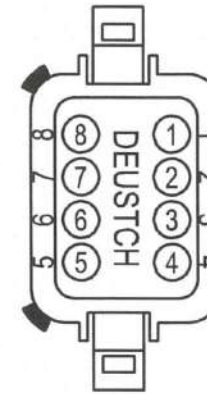

PH1(DC) - PORT HULL PLUG 1

CONN: DT06-6S-P012
 SOCKETS, REEL: 1062-14-0122
 WEDGELOCK: W6S-P012

1	14GA RED/BLU	"CKPT DC FRIDGE"
2	16GA WHITE	"FWD PORT SPKR(+)"
3	16GA WHT/BLK	"FWD PORT SPKR(-)"
4	16GA GRAY	"FWD STBD SPKR(+)"
5	16GA GRY/BLK	"FWD STBD SPKR(-)"
6	14GA RED	"12V ACC DECK PWR"

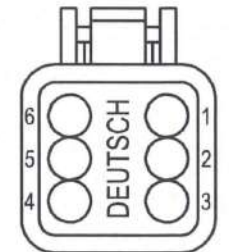

PH2(AC) - PORT HULL PLUG 2

W14/3-B BOAT CABLE
 CONN: DT06-6S-P012
 SOCKETS, LOOSE: 0462-209-16141
 WEDGELOCK: W6S-P012

1	14GA BLK (HOT)	
2	14GA WHT (NEU)	"CKPT FRIDGE"
3	14GA GRN (GRN)	
4	14GA BLK (HOT)	
5	14GA WHT (NEU)	"CKPT OUTLET"
6	14GA GRN (GRN)	

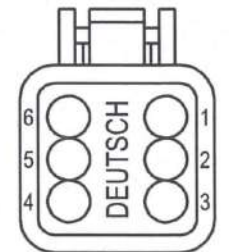

***USE GLUE KIT 3M Acrylic Adhesive DP805:
 021200-83758
 021200-85801
 MOUNTING HOLE MUST BE FULLY EXPOSED!

SCPLBR - STBD CKPT LTS BUSSED RECEPTACLE

CONN: DT06-12SA-P012
 REEL SOCKETS: 1062-14-0122
 SOCKETS, LOOSE (POS 1): 0462-209-16141
 WEDGELOCK: W12S-P012
 BUSSED RECEPTACLE: DT04-12PA-P016
 ***MOUNTING CLIP: 1011-026-0205

1	16GA BLU/WHT	"CKPT LTS LINK"
2	16GA BLU/WHT	"CKPT LTS(SD)"
3	16GA BLU/WHT	"HELM CKPT LT"
4	16GA BLU/WHT	"HELM STOR BOX LT"
5	16GA BLU/WHT	"S.AFT CKPT LT"
6	16GA BLU/WHT	"S.AFT STOR BOX LT"
7	16GA BLU/WHT	"S.ARMREST BOX LT"
8	16GA BLU/WHT	"S.FWD BOX LT"
9	16GA BLU/WHT	"S.FWD CKPT LT"
10	16GA BLU/WHT	"S.VENT LT"
11	16GA BLU/WHT	"WALKWAY CKPT LT"
12	---	CAVITY PLUG---

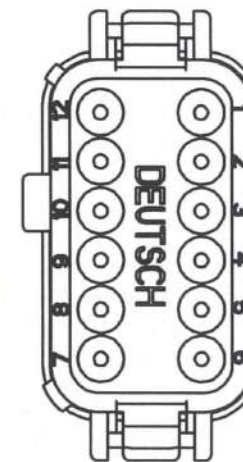

SD - STBD DECK CONNECTOR

CONN: DT06-6S-P012
 SOCKETS, REEL: 1062-14-0122
 WEDGELOCK: W6S-P012

1	14GA ORG	"HORN"
2	16GA GRY/GRN	"NAV LTS"
3	14GA GRN	"WIPER"
4	14GA WHITE	"WIPER PARK"
5	---	CAVITY PLUG---
6	16GA BLU/WHT	"CKPT LTS(SD)"



328 Super Sport

OPTIONAL ELECTRIC GRILL HARNESS

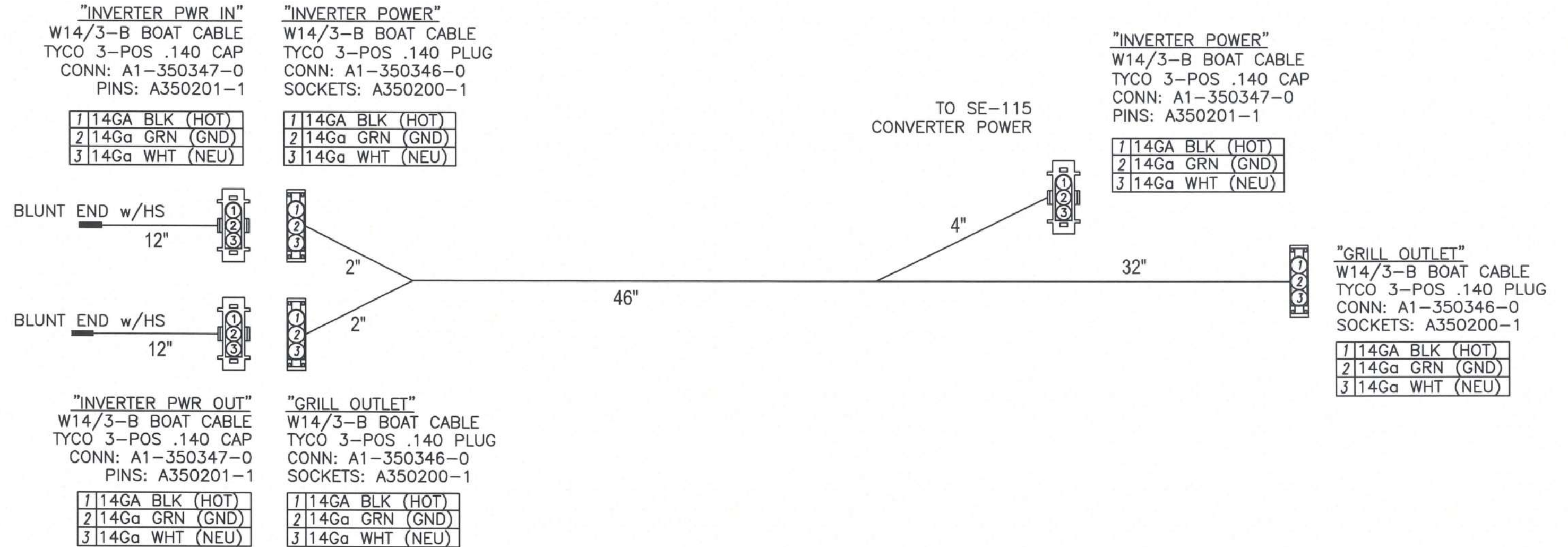

328 Super Sport

ENGINE HATCH HARNESS

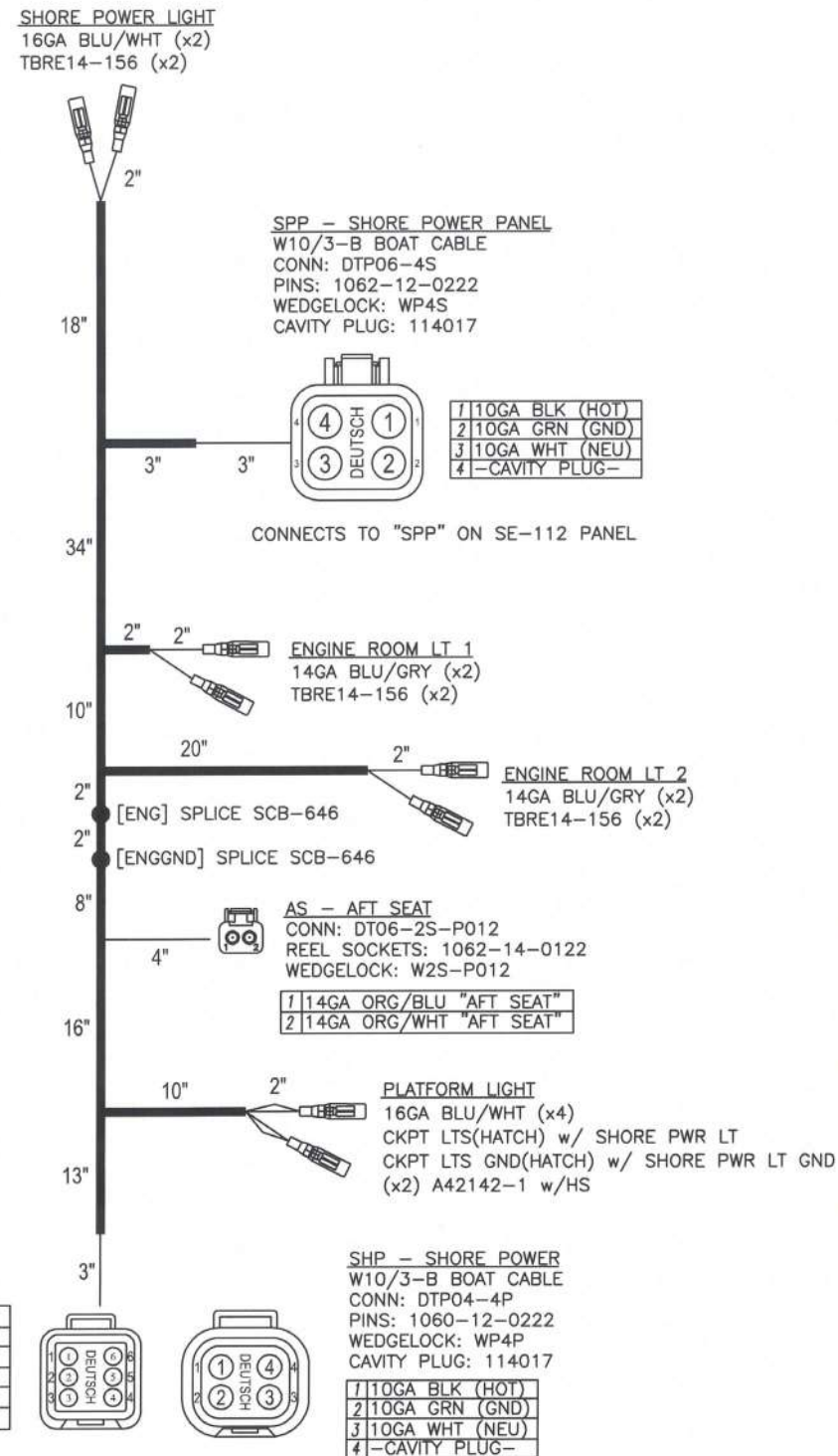

THESE TWO RECEPTACLES CONNECT TO "H" AND "SHP" ON SE-115
COCKPIT LIGHTS CIRCUIT CONSISTS OF PLATFORM LIGHT AND SHOREPOWER LIGHT

STEREO UPGRADE HARNESS

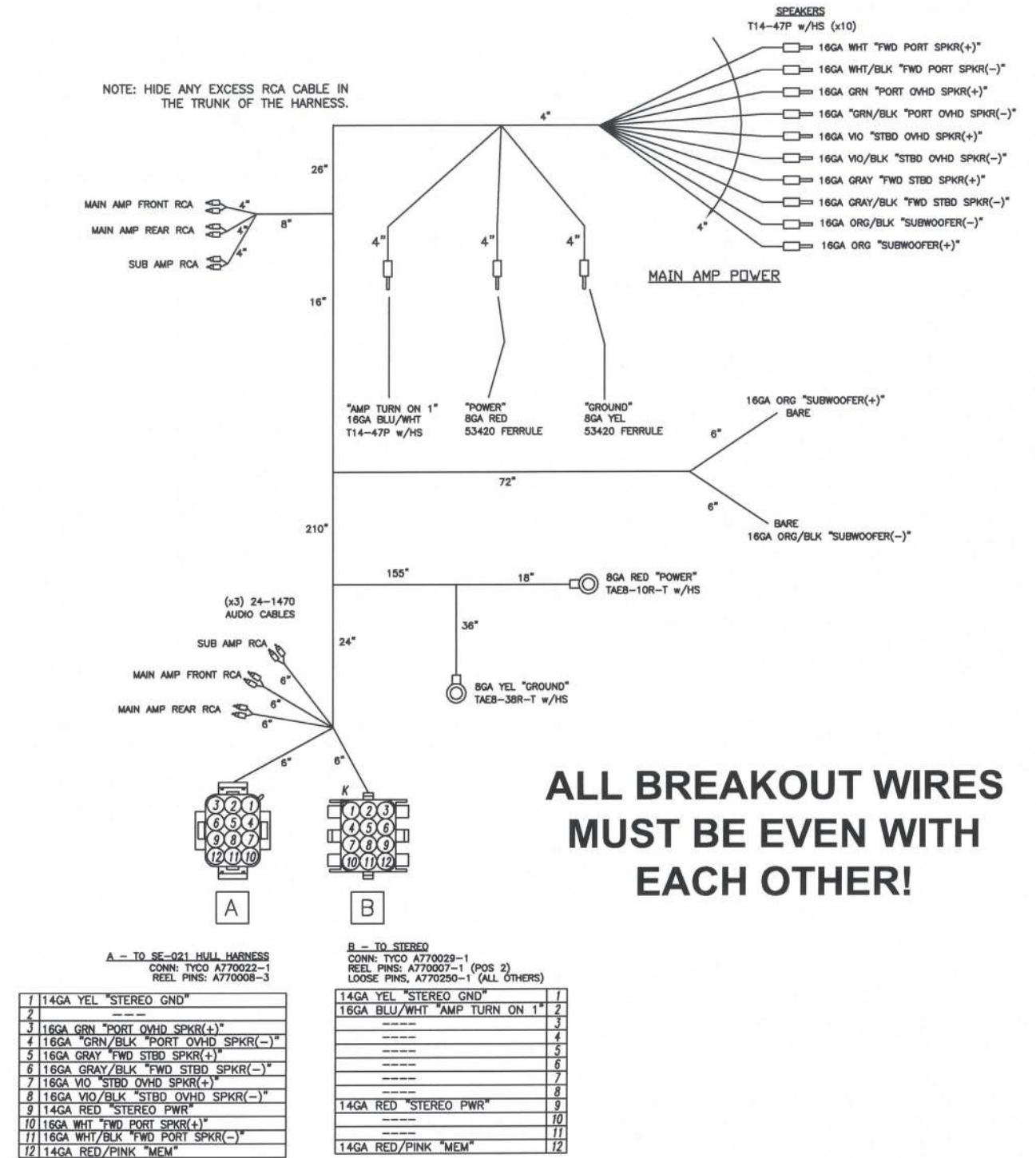

328 Super Sport

HELM ACCESSORY BREAKER PANEL

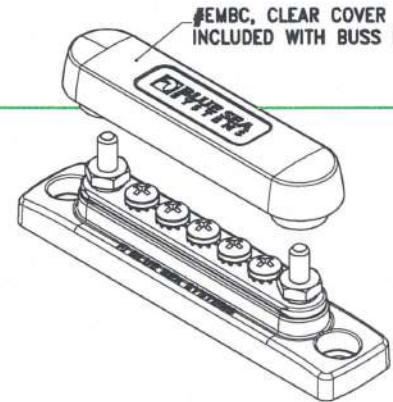
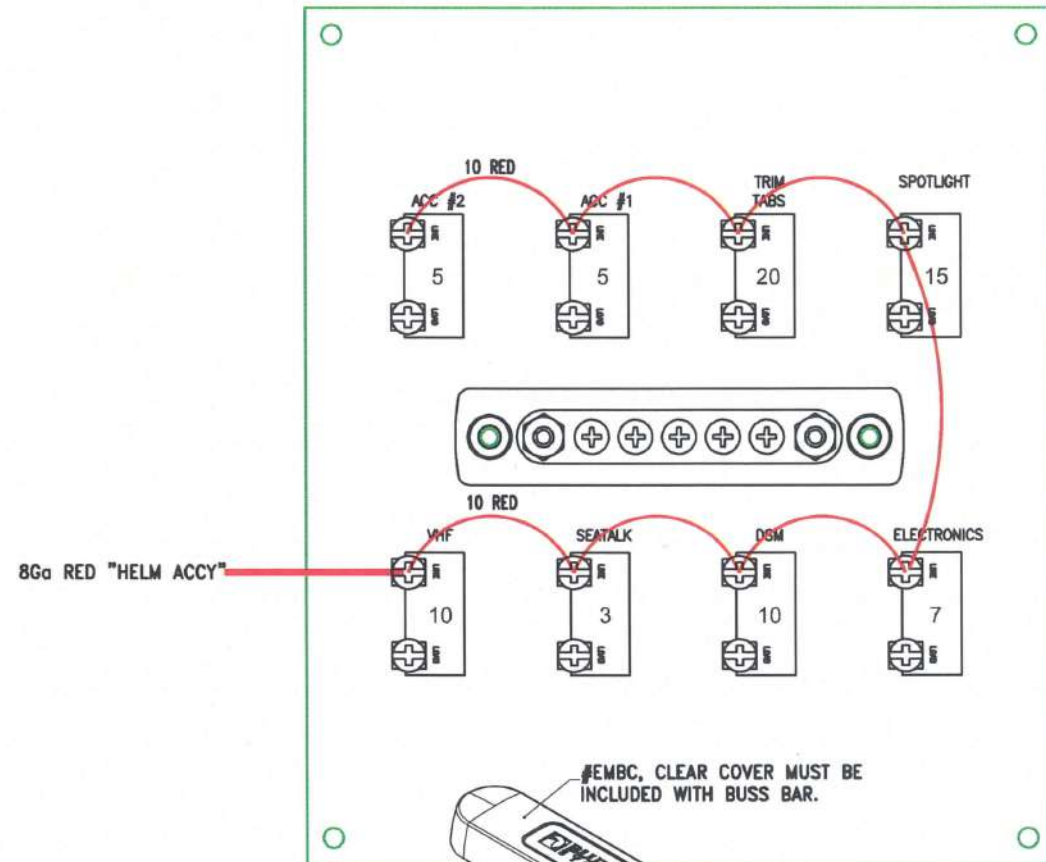
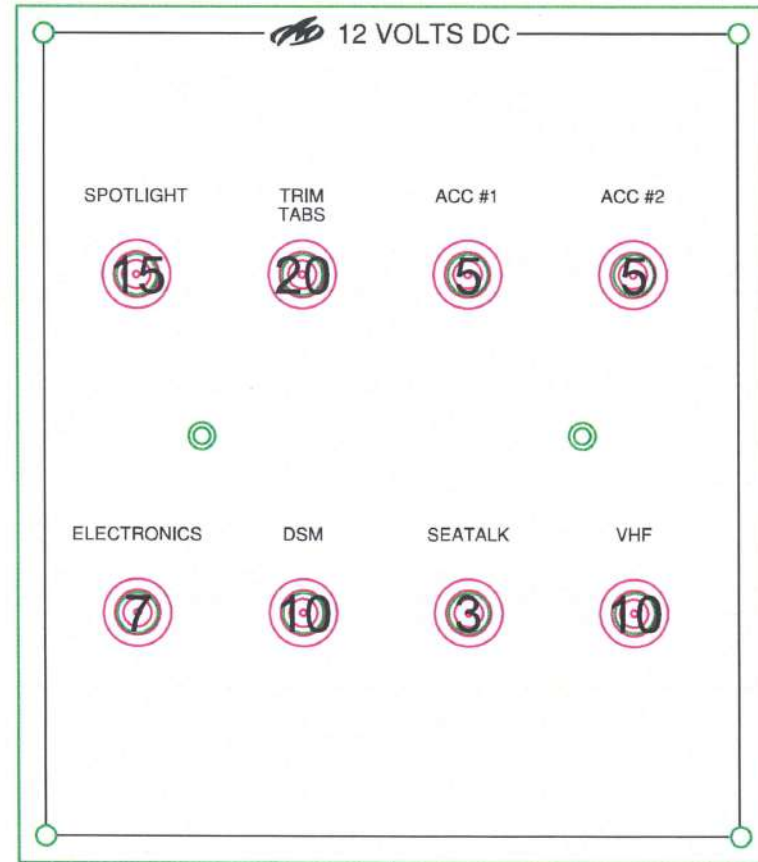

#EMBC, CLEAR COVER MUST BE INCLUDED WITH BUSS BAR.

HA - CONNECTS TO HA ON 328 HULL



8"

NOTES

1. LABEL ALL CONNECTORS WITH PROPER LETTER.
2. USE ONLY WST WIRE ON PANEL.
3. USE ONLY HEAT SHRINK TERMINALS.
4. PANEL MATERIAL IS .090 ALUMINUM
5. POWDER COAT IS BLACK AND SCREEN IS WHITE.
6. USE BLACK SCREWS TO MOUNT HARDWARE.
7. ADD PLASTIC WASHERS BETWEEN PANEL AND BREAKERS.
8. USE SPLIT LOCK WASHERS ON ALL SCREW TERMINALS.

328 Super Sport

HULL HARNESS

ALL BREAKOUT WIRES MUST BE EVEN WITH EACH OTHER!

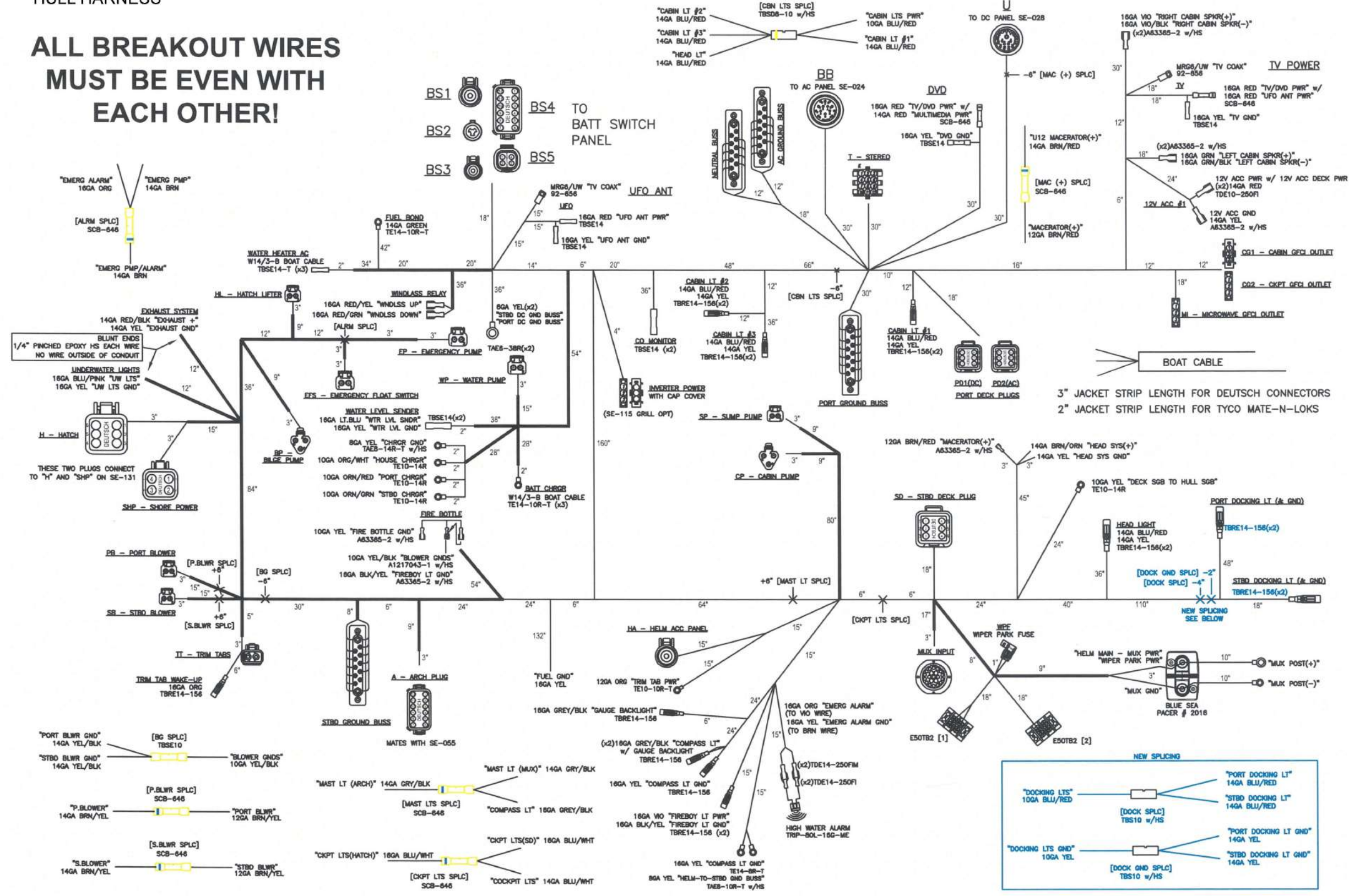

328 Super Sport

HULL HARNESS CONNECTORS

A - ARCH PLUG
 CONN: DT06-12SA-P012
 REEL SOCKETS: 1062-14-0122
 LOOSE SOCKETS: 0462-209-16141
 WEDGELOCK: W12S-P012

1	16GA VIO "STBD OVHD SPKR(+)"
2	16GA VIO/BLK "STBD OVHD SPKR(-)"
3	16GA GRN "PORT OVHD SPKR(+)"
4	16GA GRN/BLK "PORT OVHD SPKR(-)"
5	14GA BLU/WHT "ARCH WHT LTS"
6	14GA BLU/RED "ARCH RED LTS"
7	- CAVITY PLUG -
8	14GA GRY/BLK "MAST LT (ARCH)"
9	14GA YEL "ARCH LTS GND"
10	- CAVITY PLUG -
11	- CAVITY PLUG -
12	- CAVITY PLUG -

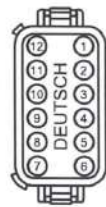

BB
 CONN: DEUTSCH HDP26-24-16SN
 REEL SOCKETS, 10GA: 1062-12-0222
 SOCKETS, LOOSE, 12-14GA: 0462-203-12141

- A.) 10GA BLK (HOT) "SHORE PWR"
- B.) 10GA WHT (NEU) "SHORE PWR"
- C.) 10GA GRN "POLARITY IND/PNL GND"
- D.) - 14017 CAVITY PLUG -
- E.) - 14017 CAVITY PLUG -
- F.) 14GA BLK (HOT) "CABIN GFCI"
- G.) 14GA BLK (HOT) "WATER HEATER"
- H.) 14GA BLK (HOT) "BATT CHRGR"
- J.) - 14017 CAVITY PLUG -
- K.) 14GA BLK (HOT) "CKPT FRIDGE"
- L.) 14GA BLK (HOT) "INVERTER PWR"
- M.) 14GA BLK (HOT) "MICROWAVE GFCI"
- N.) - 14017 CAVITY PLUG -
- P.) 10GA WHT "NEUTRAL BUSS"
- R.) - 14017 CAVITY PLUG -
- S.) - 14017 CAVITY PLUG -

TO AC PANEL SE-024

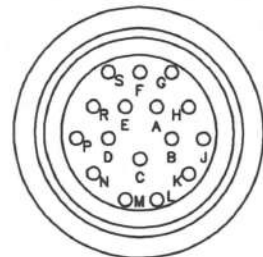

BP - BILGE PUMP
 CONN: DT06-3S-P012
 SOCKETS, LOOSE: 0462-209-16141
 WEDGELOCK: W3S-P012

1	14GA BRN "BILGE PMP FLOAT"
2	14GA YEL "BILGE PMP GND"
3	14GA BRN/WHT "BILGE PMP SW"



BS1
 CONN: DEUTSCH DTHD06-1-4S
 SOCKET: 0462-203-04141

1	16GA RED "HELM MAIN - MUX PWR"
---	--------------------------------



BS2
 CONN: DEUTSCH DTHD04-1-8P
 PIN: 0460-204-08141

1	16GA RED "DC (CABIN) MAIN"
---	----------------------------



BS3
 CONN: DEUTSCH DTHD06-1-8S
 SOCKET: 0462-203-08141

1	16GA RED/WHT "HELM ACCY PANEL"
---	--------------------------------



BS4
 CONN: DT06-12SA-P012
 REEL SOCKETS: 1062-14-0122
 WEDGELOCK: W12S-P012

1	14GA BRN "BILGE PMP FLOAT"
2	14GA BRN/ORG "BILGE PMP SWT +"
3	14GA BRN "CABIN PMP FLOAT"
4	14GA BRN/ORG "CABIN PMP SWT +"
5	14GA BRN "EMERG PMP FLOAT"
6	16GA RED/WHT "CO MONITOR"
7	14GA RED/GRN "STBD IGN"
8	14GA RED/PNK "PORT IGN"
9	14GA BRN/BLK "SUMP PMP"
10	14GA ORG/BLU "AFT SEAT"
11	14GA ORG/WHT "AFT SEAT"
12	- CAVITY PLUG -

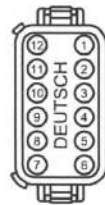

BSS
 CONN: DTP04-4P
 SOCKETS: 1060-12-0222
 WEDGELOCK: WP4P

1	10GA ORG/WHT "HOUSE CHRGR"
2	10GA ORG/RED "PORT CHRGR"
3	10GA ORG/GRN "STBD CHRGR"
4	--- CAVITY PLUG ---



CG1 - "CABIN GFCI" OUTLET
 W14/3-B BOAT CABLE
 TYCO 3-POS .140 CAP
 CONN: A1-350347-0
 PINS: A350201-1

1	14GA BLK (HOT)
2	14GA GRN (GND)
3	14GA WHT (NEU)



CG2 - "CKPT GFCI" OUTLET
 W14/3-B BOAT CABLE
 TYCO 3-POS .140 PLUG
 CONN: A1-350346-0
 SOCKETS: A350200-1

1	14GA BLK (HOT)
2	14GA GRN (GND)
3	14GA WHT (NEU)



CP - CABIN PUMP
 CONN: DT06-3S-P012
 SOCKETS: 0462-209-16141
 WEDGELOCK: W3S-P012

A	14GA BRN "CABIN PMP FLOAT"
B	14GA YEL "CABIN PMP GND"
C	14GA BRN/WHT "CABIN PMP SW"



EFS - EMERGENCY FLOAT SWITCH
 CONN: DT06-2S-P012
 SOCKET, REEL (POS 2): 1062-14-0122
 SOCKET, LOOSE: 0462-209-16141
 WEDGELOCK: W2S-P012

1	14GA BRN "EMERG PMP FLOAT"
2	14GA BRN "EMERG PMP/ALARM"



EP - EMERGENCY PUMP
 CONN: DT06-2S-P012
 SOCKET, REEL (POS 1): 1062-14-0122
 SOCKET, LOOSE: 0462-209-16141
 WEDGELOCK: W2S-P012

1	14GA BRN "EMERG PMP"
2	14GA YEL "EMERG PMP GND"



H - HATCH
 CONN: DT06-6S-P012
 LOOSE SOCKETS: 0462-209-16141
 WEDGELOCK: W6S-P012

1	14GA BLU/GRY "ENG ROOM LTS"
2	14GA YEL "ENG ROOM LTS GND"
3	16GA BLU/WHT "CKPT LTS(HATCH)"
4	16GA YEL "CKPT LTS GND(HATCH)"
5	14GA ORG/BLU "AFT SEAT"
6	14GA ORG/WHT "AFT SEAT"



HA - HELM ACCY PANEL
 CONN: DEUTSCH DTHD06-1-8S
 SOCKET: 0462-203-08141

1	16GA RED/WHT "HELM ACCY PANEL"
---	--------------------------------



HL - HATCH LIFTER
 CONN: DT06-2S-P012
 SOCKETS: 0462-209-16141
 WEDGELOCK: W2S-P012

1	14GA BLK/WHT "HATCH DN"
2	14GA RED/WHT "HATCH UP"



"INVERTER POWER" - FROM BB-L
 W14/3-B BOAT CABLE
 TYCO 3-POS .140 PLUG
 CONN: A1-350346-0
 SOCKETS: A350200-1

1	14GA BLK (HOT)
2	14GA GRN (GND)
3	14GA WHT (NEU)



CAP COVER
 TYCO 3-POS .140 CAP
 CONN: A1-350347-0

328 Super Sport

HULL HARNESS CONNECTORS PG. 2

MI - "MICROWAVE GFCI" OUTLET
W14/3-B BOAT CABLE
TYCO 3-POS .140 PLUG
CONN: A1-350346-0
SOCKETS: A350200-1

1	14GA BLK (HOT)
2	14Ga GRN (GND)
3	14Ga WHT (NEU)



PB - PORT BLOWER
CONN: DT06-2S-P012
REEL SOCKETS: 1062-14-0122
WEDGELOCK: W2S-P012

1	14GA BRN/YEL "P.BLOWER"
2	14GA YEL/BLK "PORT BLOWER GND"



SD - STBD DECK PLUG
CONN: DEUTSCH DT04-6P
PIN, REEL (POS 1): 1060-14-0122
PINS, LOOSE: 0460-215-16141
WEDGELOCK: W6P

1	14GA ORG "HORN"
2	16GA GRY/GRN "NAV LTS"
3	14GA GRN "WIPER"
4	14GA WHITE "WIPER PARK"
5	--- CAVITY PLUG ---
6	16GA BLU/WHT "CKPT LTS(SD)"



U - DEUTSCH HDP24-24-18PN
PIN: 0460-204-08141 (POS 1)
PINS: 1060-12-0222 (10GA, POS 8)
LOOSE PINS: 0460-215-16141 (POS 11, 14)
REEL PINS: 1060-14-0122 (ALL OTHERS)

1	8GA RED "DC (CABIN) MAIN"
2	16GA LT. BLU "WTR LVL SNDR"
3	14GA RED "MULTIMEDIA PWR"
4	14GA BRN "WTR PMP"
5	- 114017 CAVITY PLUG -
6	- 114017 CAVITY PLUG -
7	- 114017 CAVITY PLUG -
8	10GA BLU/RED "CABIN LTS PWR"
9	14GA RED/BLU "CKPT DC FRIDGE"
10	14GA BRN/ORN "HEAD SYS(+)"
11	14GA RED "STEREO PWR"
12	14GA BRN/RED "U12 MACERATOR(+)"
13	14GA RED "12V ACC PWR"
14	14GA YEL "DC PANEL GND"
15	- 114017 CAVITY PLUG -
16	- 114017 CAVITY PLUG -
17	- 114017 CAVITY PLUG -
18	- 114017 CAVITY PLUG -

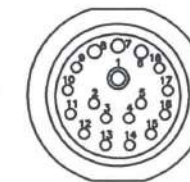

MUX - MUX INPUT

CONN: DEUTSCH HDP24-24-21PN
PINS, 10GA: 1060-12-0222
PINS, 12GA: 0460-204-12141
PINS, REEL, 16-14GA: 1060-14-0122
PINS, LOOSE, 16-14GA: 0460-215-16141

- A. 16GA GRY/GRN "NAV LTS"
- B. 12GA BRN/YEL "PORT BLWR"
- C. 16GA BLU/PINK "UW LTS"
- D. 12GA BRN/YEL "STBD BLWR"
- E. 14GA ORG "HORN"
- F. 14GA GRY/BLK "MAST LT (MUX)"
- G. 10GA BLU/RED "DOCKING LTS"
- H. 14GA RED/BLK "EXHAUST +"
- J. 14GA BLU/WHT "COCKPIT LTS"
- K. 14GA BLU/RED "ARCH RED LTS"
- L. 14GA BLU/WHT "ARCH WHT LTS"
- M. 14GA BLU/GRY "ENG ROOM LTS"
- N. 16GA RED/YEL "WINDLASS UP"
- P. 16GA RED/GRN "WINDLASS DOWN"
- R. 14GA BRN/WHT "BILGE PMP SW"
- S. 14GA BRN/WHT "CABIN PMP SW"
- T. 14GA GRN "WIPER"
- U. 14GA RED/WHT "HATCH UP"
- V. 14GA BLK/WHT "HATCH DN"
- W. 14GA BRN/ORG "BILGE PMP SWT +"
- X. 14GA BRN/ORG "CABIN PMP SWT +"

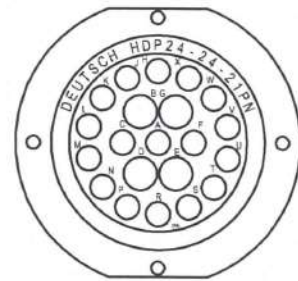

PD1(DC) - PORT DECK PLUG 1
CONN: DEUTSCH DT04-6P
PINS, REEL: 1060-14-0122
WEDGELOCK: W6P

1	14GA RED/BLU "CKPT DC FRIDGE"
2	16GA WHITE "FWD PORT SPKR(+)"
3	16GA WHT/BLK "FWD PORT SPKR(-)"
4	16GA GRAY "FWD STBD SPKR(+)"
5	16GA GRY/BLK "FWD STBD SPKR(-)"
6	14GA RED "12V ACC DECK PWR"



SHP - SHORE PWR
W10/3-B BOAT CABLE
CONN: DEUTSCH DTP06-4S
SOCKETS: 1062-12-0222(x3)
WEDGELOCK: WP4S

1	10GA BLK (HOT)
2	10GA GRN (GND)
3	10GA WHT (NEU)
4	---CAVITY PLUG---



SP - SUMP PUMP
CONN: DT06-2S-P012
SOCKETS: 0462-209-16141
WEDGELOCK: W2S-P012

1	14GA BRN/BLK "SUMP PMP"
2	14GA YEL "SUMP PMP GND"



WP - WATER PUMP
CONN: DEUTSCH DT06-2S-P012
SOCKETS: 0462-209-16141
WEDGELOCK: W2S-P012

1	14GA BRN "WTR PMP"
2	14GA YEL "WTR PMP GND"



PD2(AC) - PORT DECK PLUG 2
W14/3-B BOAT CABLE
CONN: DEUTSCH DT04-6P
PINS, LOOSE: 0460-215-16141
WEDGELOCK: W6P

1	14GA BLK (HOT)
2	14GA WHT (NEU) "CKPT FRIDGE"
3	14GA GRN (GRN)
4	14GA BLK (HOT)
5	14GA WHT (NEU) "CKPT GFCI"
6	14GA GRN (GRN)



IT - TRIM TABS
CONN: DTP06-2S
SOCKETS: 0462-203-12141
WEDGELOCK: WP2S

1	12GA ORG "TRIM TAB PWR"
2	12GA YEL "TRIM TAB GND"



SB - STBD BLOWER
CONN: DT06-2S-P012
REEL SOCKETS: 1062-14-0122
WEDGELOCK: W2S-P012

1	14GA BRN/YEL "S.BLOWER"
2	14GA YEL/BLK "STBD BLOWER GND"

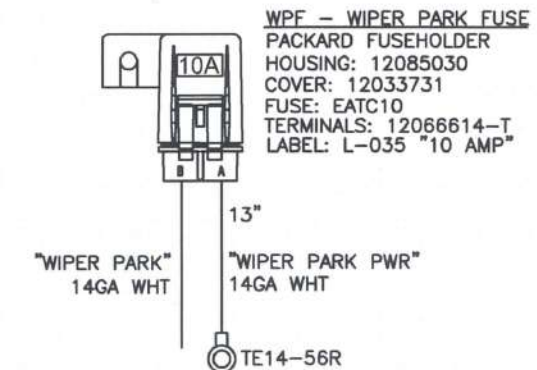

328 Super Sport

HULL HARNESS STEREO CONNECTOR

T – STEREO

CONN: TYCO A770029-1

LOOSE PIN, POS 1: A770250-1

REEL PINS (x2 WIRES): A770003-3

REEL PINS: A770007-1 (ALL OTHERS)

1.	14GA YEL "STEREO GND"
2.	-----
3.	16GA GRN "PORT OVHD SPKR(+)"
4.	16GA "GRN/BLK "PORT OVHD SPKR(-)"
5.	16GA GRAY "FWD STBD SPKR(+)" w/16GA VIO "RIGHT CABIN SPKR(+)"
6.	16GA GRAY/BLK "FWD STBD SPKR(-)" w/16GA VIO/BLK "RIGHT CABIN SPKR(-)"
7.	16GA VIO "STBD OVHD SPKR(+)"
8.	16GA VIO/BLK "STBD OVHD SPKR(-)"
9.	14GA RED "STEREO PWR" w/ 14GA RED/PINK "MEM"
10.	16GA WHT "FWD PORT SPKR(+)" w/16GA GRN "LEFT CABIN SPKR(+)"
11.	16GA WHT/BLK "FWD PORT SPKR(-)" w/16GA GRN/BLK "LEFT CABIN SPKR(-)"
12.	14GA RED/PINK "MEM"

STEREO
MEM
JUMPER

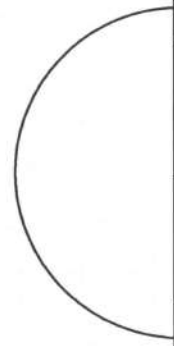

STEREO PLUG

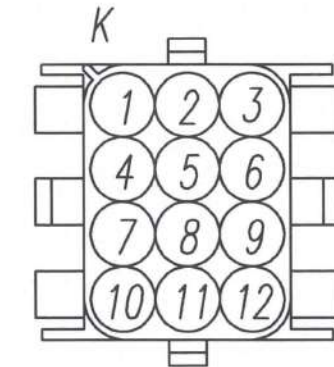

328 Super Sport

TWIM MERC DTS BATTERY WIRING DIAGRAM

NOTE: DTS ACCESSORY POWER RELAY HARNESS (GREY) IS NOT USED ON 328. IT IS INCLUDED IN HULL HARNESS.

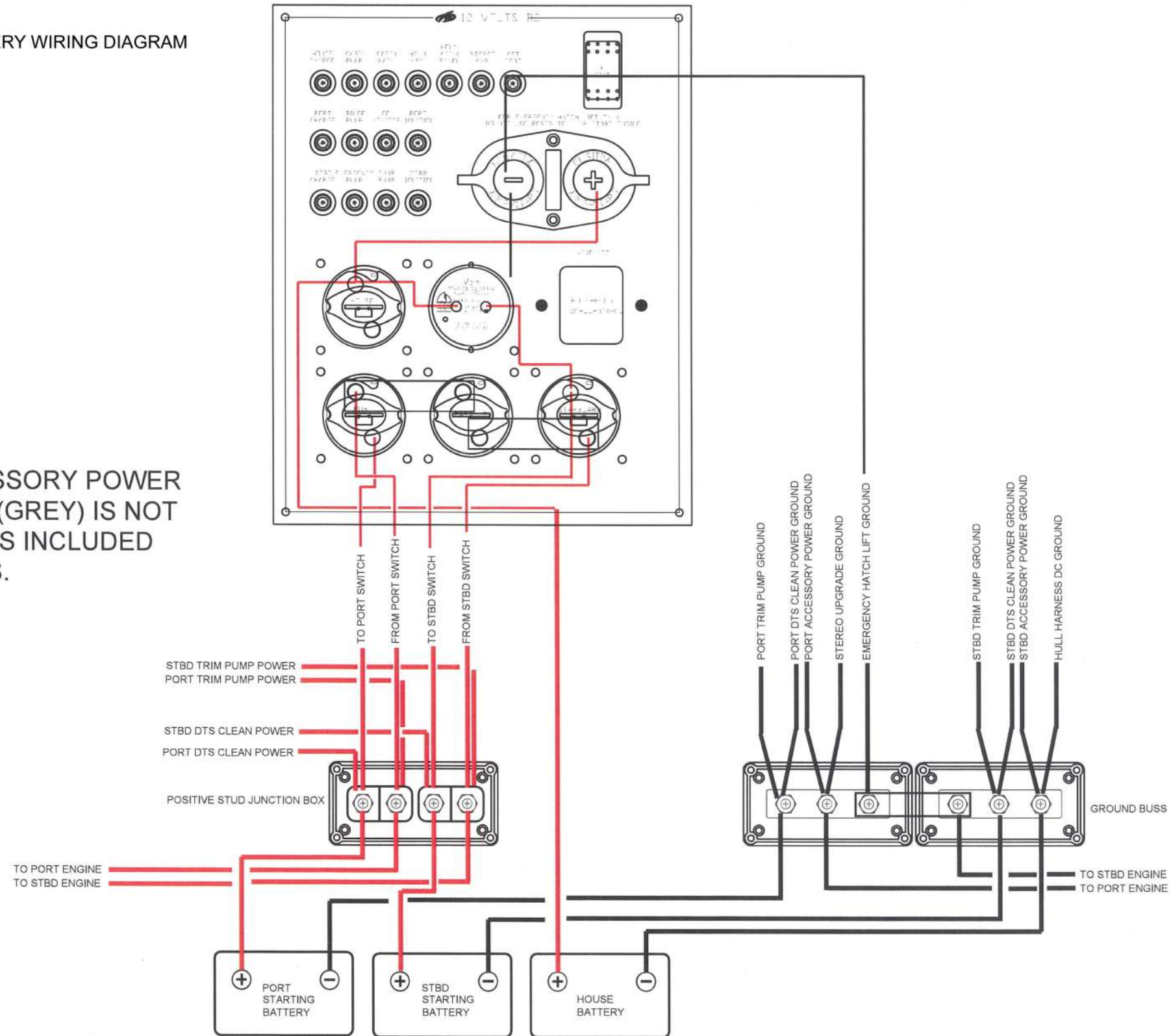

328 Super Sport

HARNESSES, ARCH

NOTES:

1. USE ONLY WST WIRE ON ALL HARNESSES EXCEPT AC HARNESSES. AC HARNESSES ARE BOAT CABLE/UL ONLY.
2. USE ONLY HEAT SHRINK TERMINALS.
3. USE ONLY WATERPROOF "F" COAX CONNECTORS #92-656.
4. ALL SPLICES NEED TO BE HEATSHRINK TERMINALS.
5. ADD YELLOW TAPE TO HARNESSES TO INDICATE SPLICE POINTS.
6. HARNESSES BREAKOUTS ARE ±1".
7. ADD CONDUIT/FLEX TO DASH AREAS EXPOSING 3" AT THE ENDS OF EACH BREAKOUT.
8. MARK CONNECTORS WITH THE PROPER LETTER OR NUMBER.

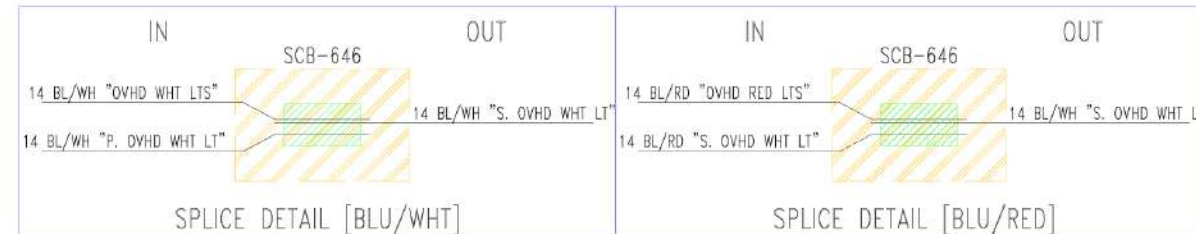

M - 12WAY DEUTSCH DT RECPT
 CONN: DT04-12PA
 LOCK: W12P

1	16Gα VIO(STBD OVHD+)
2	16Gα VIO/BLK(STBD OVHD-)
3	16Gα GREEN(PORT OVHD+)
4	16Gα GRN/BLK(PORT OVHD-)
5	14Gα BLU/WH(THT LTS)
6	14Gα BLU/RED(RED LTS)
7	14Gα GRAY(FWD MAST+)
8	14Gα GRY/BLK(AFT MAST-)
9	14Gα YELLOW (LIGHTS GND)
10	-CAVITY PLUG-
11	-CAVITY PLUG-
12	-CAVITY PLUG-

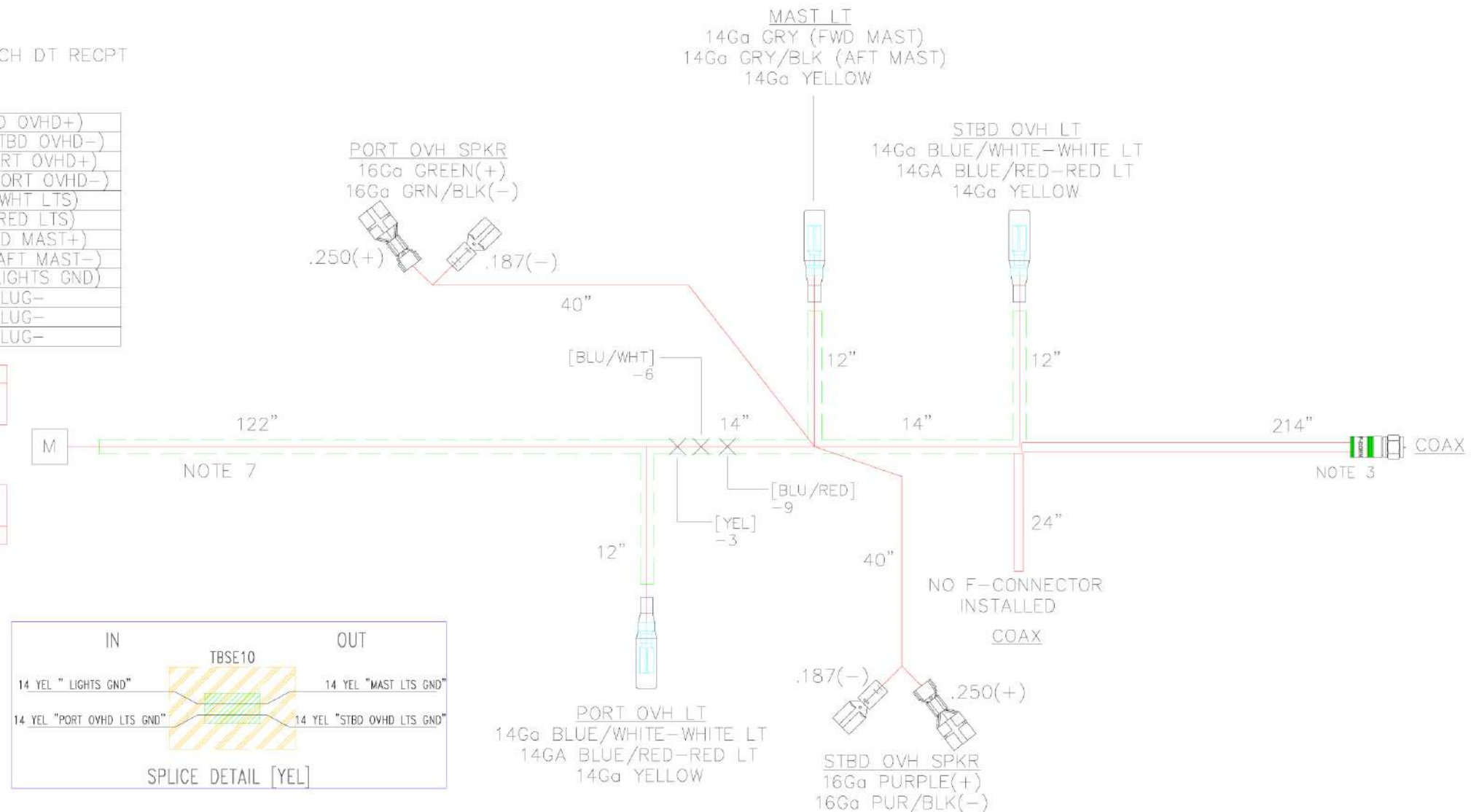
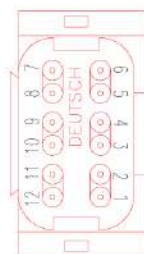

328 Super Sport

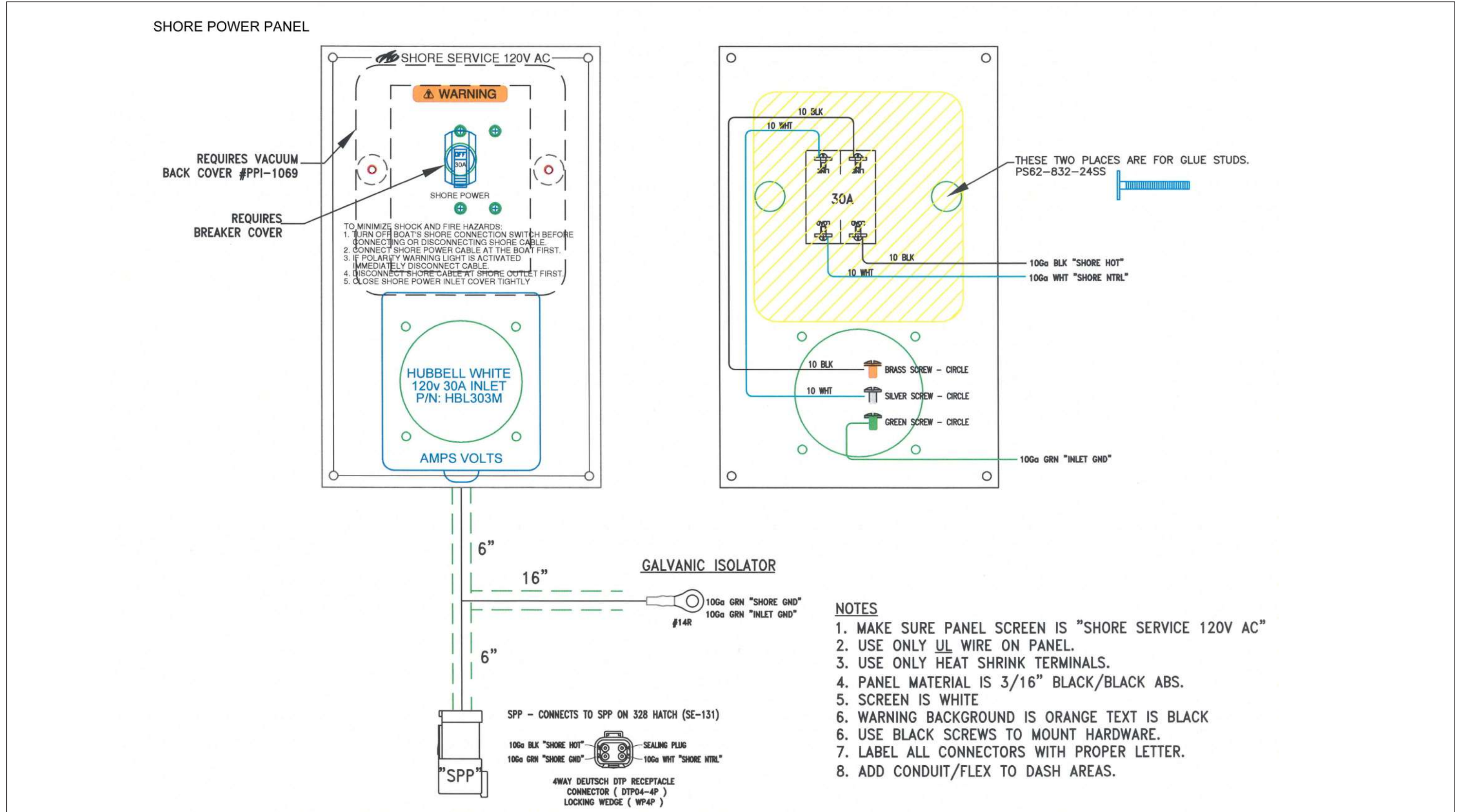

328 Super Sport

TWIN VOLVO EVC BATTERY WIRING DIAGRAM

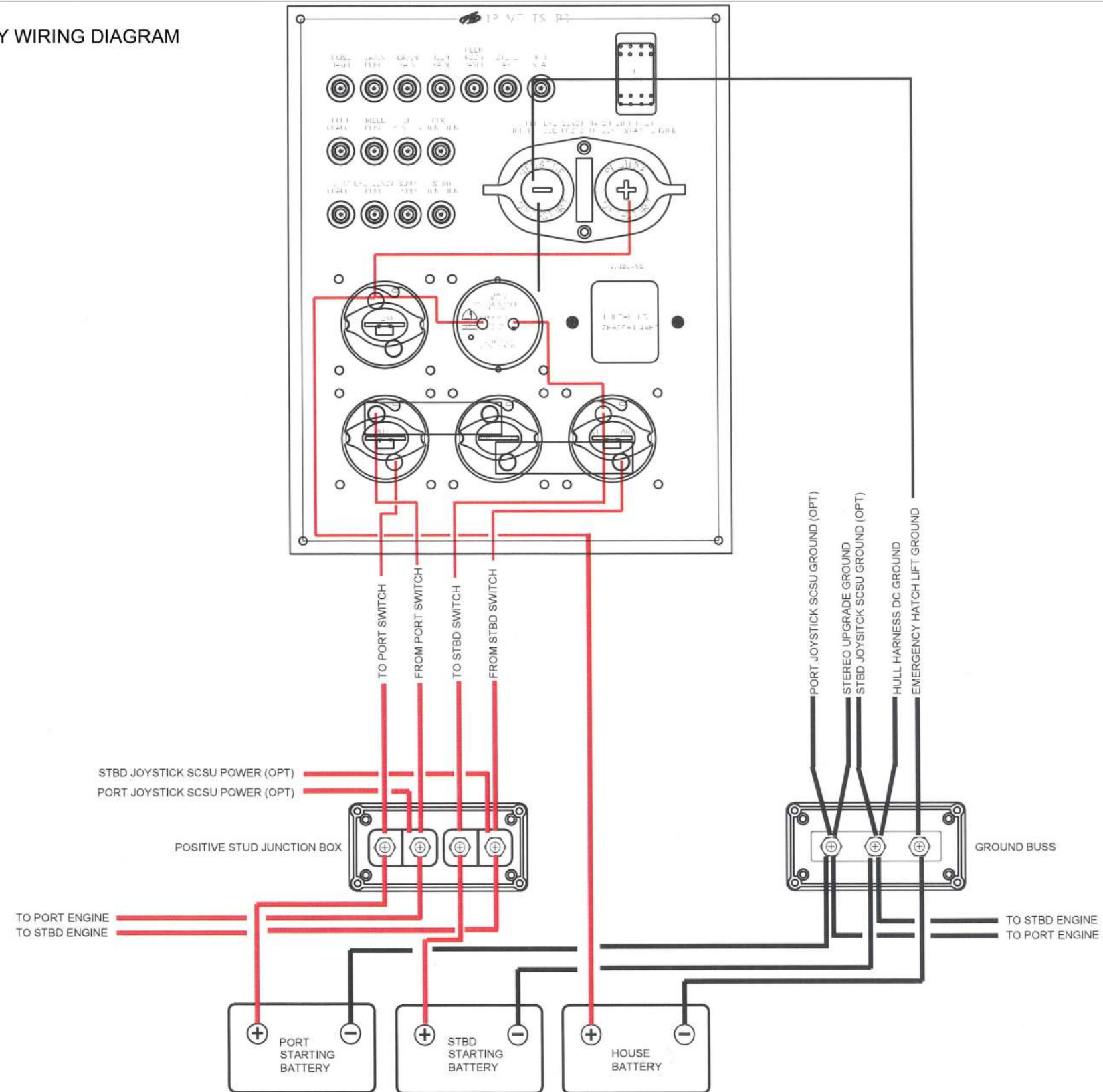

THIS PAGE WAS LEFT BLANK
INTENTIONALLY

Occupant Seating

214SS/218SS Occupant Seating

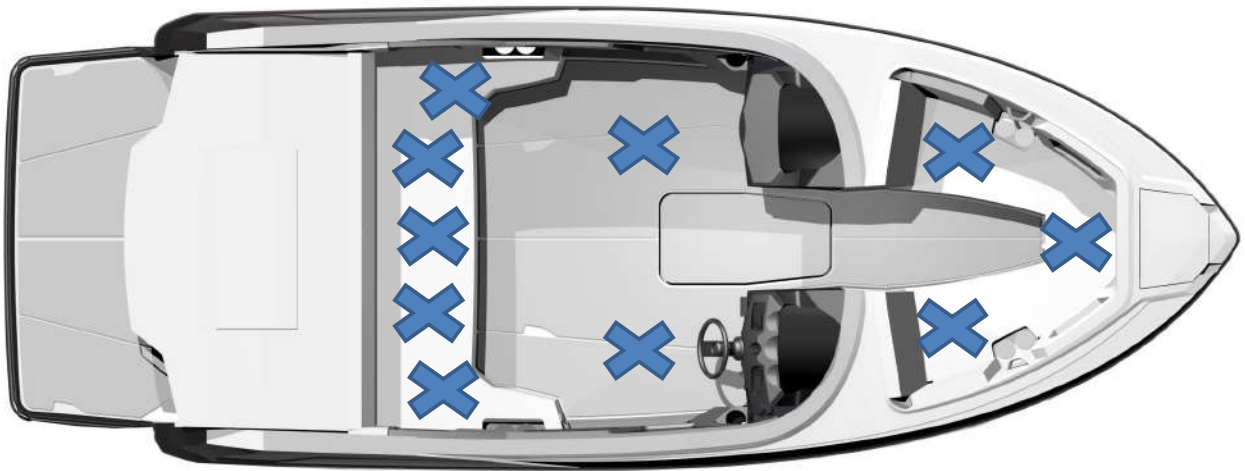

234SS/238SS Occupant Seating

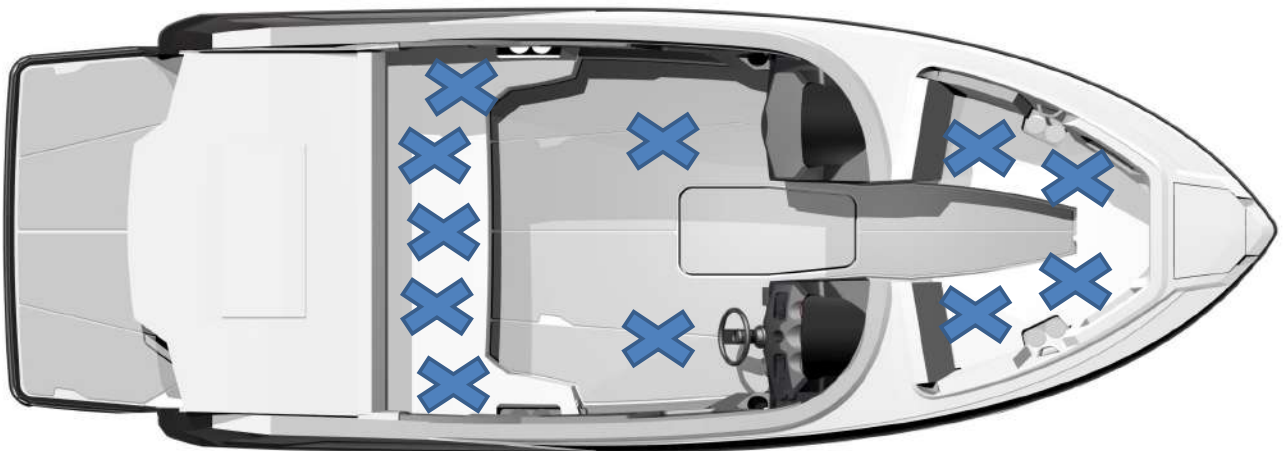

THIS PAGE WAS LEFT BLANK
INTENTIONALLY

Specifications

214/218 Super Sport

SPECIFICATION ITEM	US UNIT	METRIC UNIT
BEAM	8'4"	2.5 M
BRIDGE CLEARANCE W/ ARCH	7'2"	2.0 M
DEADRISE	19 DEGREES	19 DEGREES
DRAFT - STERN DRIVE DOWN	35"	89 CM
DRAFT - STERN DRIVE UP	23"	59 CM
DRY WEIGHT	3,650 LBS	1,656 KG
FUEL CAPACITY	36 GAL	136 LTR
LOA W/ SWIM PLATFORM	21'8"	6.6 M
MAX PERSONS W/ GEAR WEIGHT	1,675 LBS	760 KG
MAX PERSONS WEIGHT	1,500 LBS	680 KG
MAX POWER	300 HP	224 KW
WATER CAPACITY	10 GAL	37.8 LTR

234/238 Super Sport

SPECIFICATION ITEM	US UNIT	METRIC UNIT
BEAM	8'6"	2.5 M
BRIDGE CLEARANCE W/ ARCH	7'3"	2.4 M
DEADRISE	20 DEGREES	20 DEGREES
DRAFT - STERN DRIVE DOWN	37"	94 CM
DRAFT - STERN DRIVE UP	25"	64 CM
DRY WEIGHT	3950 LBS	1792 KG
FUEL CAPACITY	52 GAL	208.2 L
LOA W/ SWIM PLATFORM	23'0"	7.01 M
MAX PERSONS W/ GEAR WEIGHT	1900 LBS	862 KG
MAX PERSONS WEIGHT	1775 LBS	805 KG
MAX POWER	300 HP	223.7 KW
WATER CAPACITY	10 GAL	37.8 L

268 Super Sport

SPECIFICATION ITEM	US UNIT	METRIC UNIT
BEAM	8'6"	2.5 M
BRIDGE CLEARANCE W/ ARCH	8'2"	2.5 M
DEADRISE	20 DEGREES	20 DEGREES
DRAFT - STERN DRIVE DOWN	40"	101.6 CM
DRAFT - STERN DRIVE UP	25"	63.5 CM
DRY WEIGHT	5500 LBS	2495 KG
FUEL CAPACITY	80 GAL	302.8 L
LOA W/ SWIM PLATFORM	26'8"	8.1 M
MAX POWER	430 HP	320.7 KW
WASTE CAPACITY	11 GAL	41.6 L
WATER CAPACITY	15 GAL	56.8 L

288 Super Sport

SPECIFICATION ITEM	US UNIT	METRIC UNIT
BEAM	9'0"	2.7 M
BRIDGE CLEARANCE W/ARCH	8'7"	2.5 M
DEADRISE	21 DEGREES	21 DEGREES
DRAFT - STERN DRIVE DOWN	37"	0.94 M
DRAFT - STERN DRIVE UP	25"	0.64 M
DRY WEIGHT	6800 LBS	3084 KG
FUEL CAPACITY	100 GAL	378.5 L
LOA W/ SWIM PLATFORM	29'0"	8.8 M
MAX POWER	430 HP	320.7 KW
WASTE CAPACITY	11 GAL	41.6 L
WATER CAPACITY	15 GAL	56.8 L

328 Super Sport

SPECIFICATION ITEM	US UNIT	METRIC UNIT
BEAM	9' 8"	2.9 M
BRIDGE CLEARANCE W/ARCH	8' 3"	2.5 M
DEADRISE	22 DEGREES	22 DEGREES
DRAFT - STERN DRIVE DOWN	39"	99 CM
DRAFT - STERN DRIVE UP	27"	68.5 CM
DRY WEIGHT	9,700 LBS	4,400 KG
FUEL CAPACITY	142 GAL	537.5 LTR
LOA W/ SWIM PLATFORM	32' 2"	9.7 M
MAX CABIN HEADROOM	4'9"	1.45 M
MAX POWER	T-430 HP	T-320.7 KW
WASTE CAPACITY	18 GAL	68 LTR
WATER CAPACITY	25 GAL	94.6 LTR

THIS PAGE WAS LEFT BLANK
INTENTIONALLY

Monterey Boats Lifetime Limited Warranty

MONTEREY BOATS warrants to the original retail purchaser of its product beginning with the 2017 models that it will repair or replace defects in materials and workmanship found to exist in its product during the applicable warranty periods defined below if purchased from an authorized MONTEREY BOATS dealer, subject to the exclusions, limitations, conditions and provisions noted below. All repairs and replacements under the following warranties will be performed by MONTEREY BOATS or an authorized MONTEREY BOATS dealer or representative selected by MONTEREY BOATS at its sole discretion.

LIFETIME LIMITED STRUCTURAL HULL AND DECK WARRANTY:

MONTEREY BOATS warrants to the original retail purchaser of its product that MONTEREY BOATS will repair or replace the fiberglass hull or deck of its product if it is found to be structurally defective in materials or workmanship for as long as the original retail purchaser owns the product. For purposes of this limited warranty: (1) a structural defect is defined as a defect that causes the hull or deck to be unsafe or unfit for use under normal operating conditions; (2) the fiberglass hull is defined as the single fiberglass molded shell and integral fiberglass structural components including stringers, transom and related structural components which are below the hull flange; and (3) the deck is defined as the single fiberglass molded shell and integral fiberglass structural components attached to the hull flange. This warranty is further subject to the exclusions, limitations, conditions and provisions noted below.

TEN-YEAR TRANSFERABLE LIMITED STRUCTURAL HULL AND DECK WARRANTY:

Beginning with the 2017 models, MONTEREY BOATS also offers a Ten-Year Transferable Limited Structural Hull and Deck Warranty. Under this warranty, MONTEREY BOATS will repair or replace the fiberglass hull or deck if it is found to be structurally defective in materials or workmanship within the first ten (10) years after the warranty commencement date. For purposes of this warranty: (1) a structural defect is defined as a defect that causes the hull or deck to be unsafe or unfit for use under normal operating conditions; (2) the fiberglass hull is defined as the single fiberglass molded shell and integral fiberglass structural components including stringers, transom and related structural components which are below the hull flange; and (3) the deck is defined as the single fiberglass molded shell and integral fiberglass structural components attached to the hull flange. This warranty may be transferred to subsequent purchasers (hereinafter "new owner") provided the new owner registers the transfer and pays the transfer fee in accordance with the requirements set forth below. This transfer will only apply to the balance of any warranty period left during the ten (10) year period commencing on the warranty commencement date.

1. The request for transfer must be made in writing by the new owner and sent within thirty (30) days of the date of his/her purchase of the boat to:

MONTEREY BOATS
1579 SW 18th Street
Williston, Florida 32696

2. The request must include: A copy of the bill of sale with the Hull ID number, the new owner's name and address and a Certified Check or Money Order for the correct transfer fee amount.

3. The transfer fee is \$300.00 for boats with hull lengths under 27', \$500.00 for boats with hull lengths from 27' but under 33', and \$700.00 for boats with hull lengths 33' and over.

In the event fiberglass hull or deck work is required, the new owner must return the boat to the original selling dealer or to a dealer authorized to service MONTEREY BOATS products. The cost of returning the boat to and from MONTEREY BOATS or an authorized MONTEREY BOATS dealer or representative will be the sole responsibility of the new owner. This warranty is further subject to the exclusions, limitations, conditions and provisions noted below.

FIVE-YEAR LIMITED HULL BLISTER WARRANTY:

MONTEREY BOATS warrants to the original retail purchaser of its product that MONTEREY BOATS will repair any osmotic blisters which occur on the underwater gelcoated surfaces of the hull as a result of defects in materials or workmanship within five (5) years from the warranty commencement date according to the following prorated schedule provided that the original factory gelcoat surface has not been altered in any way:

1. Up to two (2) years from the warranty commencement date, MONTEREY BOATS will pay 100% of the repair costs.
2. After two (2) years but up to three (3) years from the warranty commencement date, MONTEREY BOATS will pay 85% of the repair costs.
3. After three (3) years but up to four (4) years from the warranty commencement date, MONTEREY BOATS will pay 65% of the repair costs.
4. After four (4) years but up to five (5) years from the warranty commencement date, MONTEREY BOATS will pay 35% of the repair costs.
5. After five (5) years from the warranty commencement date, MONTEREY BOATS will pay 0% of the repair costs.

Alterations which will void this warranty include, without limitation, damage, accident repair, sanding, scraping, sandblasting, or improper surface preparation for application of a marine barrier coating or bottom paint. A marine barrier coating must be properly applied to the hull bottom if the boat is to be moored in water for periods of more than sixty (60) days in any ninety (90) day period and a marine barrier coating is also required if the boat is to be bottom painted. This warranty is further subject to the exclusions, limitations, conditions and provisions noted below.

THREE-YEAR EXTERIOR COSMETIC GELCOAT LIMITED WARRANTY:

MONTEREY BOATS warrants to the original retail purchaser of its product that MONTEREY BOATS will correct or repair any cracking or crazing of, and any air voids in, the exterior gelcoat surface of the boat as a result of defects in materials or workmanship within three (3) years from the warranty commencement date according to the following prorated schedule provided that the original factory gelcoat surface has not been altered in any way:

1. Up to one (1) year from the warranty commencement date, MONTEREY BOATS will pay 100% of the repair costs.
2. After one (1) year but up to two (2) years from the warranty commencement date, MONTEREY BOATS will pay 50% of the repair costs.

3. After two (2) years but up to three (3) years from the warranty commencement date, MONTEREY BOATS will pay 25% of the repair costs.

4. After three (3) years from the warranty commencement date, MONTEREY BOATS will pay 0% of the repair costs.

Alterations which will void this warranty include, without limitation, damage, accident repair, sanding, scraping, sandblasting, improper surface preparation for application of a marine barrier coating or paint, or if damage to the exterior gelcoat surface results from or is attributable to the addition of items not installed by MONTEREY BOATS. This warranty expressly excludes from coverage blushing of colored gelcoat below the waterline and is further subject to the exclusions, limitations, conditions and provisions noted below.

LIMITED WARRANTY FOR NON-STRUCTURAL PARTS AND COMPONENTS:

MONTEREY BOATS warrants to the original retail purchaser of its product that MONTEREY BOATS will repair or replace the following described non-structural parts and components for the reasons and during the periods indicated below measured from the warranty commencement date whether or not separately warranted by the part or component manufacturer:

1. Canvas: if it fades or dry rots within five (5) years or if it is found to be defective in materials or workmanship within two (2) years.
2. Upholstery: if it is found to be defective in materials or workmanship within three (3) years.
3. Generators: if it is found to be defective in materials or workmanship within five (5) years.
4. All other non-structural parts and components: if they are found to be defective in materials or workmanship within one (1) year.

WHAT IS NOT COVERED:

The limited warranties set forth above do not cover:

1. Engines, outdrives, air conditioners, and trim tabs;
2. Any boat that has been repaired or altered by persons other than MONTEREY BOATS or an authorized MONTEREY BOATS dealer or representative or modified in any way so as to affect its use and operation;
3. Any boat used for racing or for rental or commercial purposes or that has been subject to misuse, neglect, accident or structural modification;
4. Normal wear, tear, deterioration (including rust) of hardware, vinyl coverings, vinyl and fabric upholstery, plastic, stainless steel, other metal, wood, and trim tape;
5. Any defect caused by the failure of the owner to provide reasonable care and maintenance;
6. Installation of engines, generators, air conditioners, wake board towers, parts or other aftermarket accessories produced, installed or attached by anyone other than MONTEREY BOATS;
7. Loss of time, inconvenience, loss of the use of the boat or other matters not specifically covered hereunder;
8. Any boat purchased from an authorized MONTEREY BOATS dealer located in the United States or Canada that is registered and/or operated outside the United States or Canada; and

9. Any boat which has previously been repossessed from an authorized MONTEREY BOATS dealer. However, this exclusion shall not affect the Lifetime Limited Structural Hull and Deck Warranty set forth above.

GENERAL PROVISIONS:

ALL GENERAL, SPECIAL, INDIRECT, INCIDENTAL AND/OR CONSEQUENTIAL DAMAGES ARE EXCLUDED FROM THIS WARRANTY AND ARE TOTALLY DISCLAIMED BY MONTEREY BOATS. IT IS THE INTENT OF THE PARTIES THAT THE OWNER'S SOLE AND EXCLUSIVE REMEDY IS THE REPAIR OR REPLACEMENT OF THE PRODUCT OR ITS ALLEGEDLY DEFECTIVE COMPONENT PARTS AND THAT NO OTHER LEGAL OR EQUITABLE REMEDIES SHALL BE AVAILABLE TO SAID OWNER. SOME STATES DO NOT ALLOW THE EXCLUSION OF INCIDENTAL OR CONSEQUENTIAL DAMAGES SO THE INCLUSION OF INCIDENTAL OR CONSEQUENTIAL DAMAGES MAY NOT APPLY TO YOU. THIS IS A LIMITED WARRANTY. MONTEREY BOATS MAKES NO WARRANTY OTHER THAN CONTAINED HEREIN. TO THE EXTENT ALLOWED BY LAW ANY WARRANTIES OF **MERCHANTABILITY OR FITNESS FOR A PARTICULAR PURPOSE** ARISING IN STATE LAW ARE EXPRESSLY EXCLUDED. TO THE EXTENT ALLOWED BY LAW, ANY IMPLIED WARRANTY OF **MERCHANTABILITY** IS LIMITED TO THE DURATION OF THE LIMITED WARRANTY APPLICABLE TO THE PARTICULAR WARRANTED PART, COMPONENT, OR DEFECT. ALL OBLIGATIONS OF MONTEREY BOATS ARE SPECIFICALLY SET FORTH HEREIN. SOME STATES DO NOT ALLOW LIMITATIONS ON HOW LONG AN IMPLIED WARRANTY LASTS, SO THE ABOVE LIMITATION MAY NOT APPLY TO YOU. MONTEREY BOATS' OBLIGATION WITH RESPECT TO THIS WARRANTY IS LIMITED TO MAKING REPAIRS TO OR REPLACING THE DEFECTIVE PARTS AND NO CLAIM FOR BREACH OF WARRANTY SHALL BE CAUSE FOR CANCELLATION OR RESCISSION OF THE CONTRACT OR SALE FOR ANY BOAT MANUFACTURED BY MONTEREY BOATS.

This Lifetime Limited Warranty commences on the date of delivery to the original retail purchaser or when the boat has been operated for twenty-five (25) hours or on the first day of the twenty-fifth (25th) month from the date of shipment from MONTEREY BOATS to an authorized MONTEREY BOATS dealer, which ever occurs first.

MONTEREY BOATS will discharge its obligations under this Lifetime Limited Warranty as rapidly as possible, but cannot guarantee any specific completion date due to the different nature of claims which may be made and services which may be required. This Lifetime Limited Warranty gives you specific legal rights, and you may also have other rights which may vary from state to state. No person, including a MONTEREY BOATS dealer, is authorized to make any repairs or replacements under this Lifetime Limited Warranty without the prior written approval of MONTEREY BOATS. MONTEREY BOATS shall in no way be responsible for any repairs not PRE-AUTHORIZED by a MONTEREY BOATS Customer Service Manager or repairs performed by a repair shop not PRE-AUTHORIZED by a MONTEREY BOATS Customer Service Manager.

MONTEREY BOATS does not authorize any person to create or assume for it any other obligation or liability with respect to its products. The sales personnel or other employees of MONTEREY BOATS dealers are not authorized to make warranties concerning MONTEREY BOATS products. No brochure,

pamphlet or other written or pictorial presentation constitutes a warranty or representation as to any aspect of MONTEREY BOATS products.

MONTEREY BOATS shall have no obligation under this Lifetime Limited Warranty unless and until each of the following conditions are met:

1. The original retail purchaser of its product or the MONTEREY BOATS dealer either completes and returns the Warranty Registration to MONTEREY BOATS by mail or facsimile or the MONTEREY BOATS dealer registers the Warranty electronically "online" within fifteen (15) days from the date the product is delivered to the original retail purchaser;
2. Notice of each warranty claim is given to the MONTEREY BOATS dealer within a reasonable period of time after discovery of any claimed defect;
3. Notice of each warranty claim is made in writing to MONTEREY BOATS within the applicable time periods identified in the respective warranties as measured from the date of purchase by the original retail purchaser; and
4. All transportation charges incurred in transporting the boat for warranty work are paid for by the owner.

MONTEREY BOATS reserves the right to make changes at any time, without notice, in prices or to make changes in design, colors, specifications, equipment, options, materials, etc., and MONTEREY BOATS shall be under no obligation to equip or modify product built prior to such changes.

IMPORTANT: Proper registration of the Warranty with MONTEREY BOATS is important for purposes of recording customer information for notification and correction of product defects under the Federal Boat Safety Act.

MONTEREY BOATS is the registered tradename and trademark of SEABRING MARINE INDUSTRIES, INC., a Florida corporation, the warrantor herein.

SEABRING MARINE INDUSTRIES, INC.

d.b.a. MONTEREY BOATS

1579 SW 18th Street – Williston, Florida 32696- Phone (352) 528-2628 / Fax (352) 529-2628



MONTEREY BOATS

1579 S.W. 18TH STREET
WILLISTON, FL 32696
PHONE: 352-529-9181 FAX: 352-529-9173

WWW.MONTEREYBOATS.COM