

MasterCraft

MariStar
by MasterCraft
Luxury Performance Powerboats

2001 Owners Manual



MasterCraft

- **19 Skier**
- **ProStar 195**
- **ProStar 190 EVO**
- **ProStar 209**
- **X-5 Wakeboard**
- **X-9 Wakeboard**
- **ProStar 205 VRS**
- **X-Star Wakeboard**

MariStar

- **MariStar 210**
- **MariStar 230**
- **MariStar 230 SV**
- **X-10 Wakeboard**
- **X-30 Wakeboard**

Congratulations on your choice of the finest ski boat available. MasterCraft is the recognized world leader for inboard ski boats today and has been for more than 30 consecutive years. The quality, innovation, selection and value are unmatched in the industry.

Please take a few minutes to read this owners manual completely in addition to carefully reviewing the Operations and Maintenance Manual that was also provided with your new boat. These publications will help answer most of the remaining questions you may have about your new boat.

Every effort has been made to make this manual accurate. All information is based on the latest product information available at the time of printing.

Because of our policy of continuous product improvement, we reserve the right to make changes at any time, without notice, in specifications and models and also to discontinue models. The right is also reserved to change specifications, parts or accessories at any time without incurring any obligation to equip the same on models manufactured before the date of the change.

The continuing accuracy of this manual cannot be guaranteed. The illustrations used in this manual are intended only as representative reference views and may not depict actual model component parts. Information about certain on-board components furnished by suppliers other than MasterCraft is provided separately. This information is available from your dealer.

**2001 Owners,
Welcome Aboard!**

The MasterCraft production facility in Vonore, Tennessee.



Here is a quick walk-through our state-of-the-art manufacturing facility, with some facts about each step of the process.

The MasterCraft Design Process: The Perfect Blending of Art and Science

Our engineers and designers have never been able to leave well enough alone. Armed with true 3-D computer-aided design technology, they have a design approach that allows them to visualize and create every part of the boat on the computer—the same way it's done in the automotive industry. No other ski boat company even comes close to our technology—or to our talent. It's the most advanced team in the business, and the fruits of its labor are evident in every 2001 MasterCraft model.

But at MasterCraft, we're not just designing better boats. We're designing better ways to build them. Today's MasterCrafts are built better, smarter and lighter. Which means you have the most durable, most carefree and most reliable boat on the planet.

Even with the most advanced technology available, however, MasterCraft will never replace an important step in the design: *hands-on involvement*. Our artisans use clay modeling, inspired by the automotive industry, to touch and feel every surface of the

boat before it ever sees a mold. Changes are made overnight. And remade over and over again until every aspect of the ergonomics, styling and design is just right. When everything is flawless, we build the part, carefully crafting each piece by hand. This careful blending of technology, experience and intuition allows us to reduce the time it takes to introduce innovations into our boats.

We're proud of the balance we've achieved and of the results we're getting. For example, parametric modeling and finite element analysis allow us to create computerized images of each part long before we build it. We zero in to test stress levels and to perfect tolerances to the last thousandth of an inch. The result is a boat that has minimum weight and maximum strength. A boat that is powerful, durable and seamless from bow to stern.

The MasterCraft LifeMaster™ Construction Process

We use an exclusive process that we call LifeMaster™, an eight-step production method that gives every MasterCraft strength and reliability that ordinary boats can not equal. We believe in this process so much that we offer a limited lifetime warranty on every new MasterCraft. The warranty is even transferable to a second owner for up to five years.

Step 1: Superior Molds

The first step in the LifeMaster™ Process is our boat molds. Our molds are built to tighter tolerances than most boats, with steel reinforcement to prevent flexing and to maintain precision. After every fourth use, molds are hand-

How Your Boat Is Built

waxed with an industrial quality paste wax. This ensures a mirror-like gelcoat finish and easy mold release. After 50 uses, every mold is sent back to the mold maintenance shop for a complete overhaul, allowing us to produce a boat with a superior finish. Also note that our molds are green in color. Our molds used to be orange, but we discovered that the green pigment was more environmentally friendly (no lead), so we switched.

Step 2: Gel coat

Boats are built from the outside in. The first layer to be applied to the mold is our special Ultimate 8000™ neopentyl glycol/isophthalic 20 mil gel coat. Our skilled production team can control our gel coat to tolerances within .005" for optimum strength, gloss and resistance to cracking, fading, blistering and water and chemical damage. Most manufacturers do not even have standards for gel coat thickness.

Some graphics are applied right in the gel coat, and this extra care pays off. New MasterCrafts come out of the mold with a gloss that looks like they were just waxed and buffed.

Step 3: Hand-Laid Fiberglass

There are many ways of building boats, but the best way we have found is to do it by hand. MasterCraft uses multiple layers of hand-laid fiberglass for the hull and structural components. Three types of fiberglass are used: matting, woven roving and coremat. There are even two types of woven roving—biaxial stitched and triaxial stitched cloth.

Why so many? Because the different types of fiberglass provide strength in different directions. The result is a hull that resists the tremendous forces generated by running across the water at high speed and taking tight turns.

Our hand-laid method is superior to chopper-gun fiberglass application because it ensures uniform strength and consistency throughout the boat. Chopper guns can create thin spots in the hull that are weak.

Step 4: Integral Monocoque™ Stringer System

MasterCraft uses no wood for structural components. Over time, wood weakens and rots. MasterCraft pioneered the use of fiberglass stringers (or hull bracing system) in ski boat construction.

All the way back in 1983, we developed an entirely new stringer system. The exclusive Monocoque™ stringers, constructed of bi-directional fiberglass and closed-cell foam, are precision built to aerospace tolerances, then fiberglassed into the hull so that they become an integral part of the structure. It is as if the hull and stringers are one single piece.

That means extra strength, more stability, and a great feel for the driver.

Step 5: Floor Liner

The fiberglass floor liner, another hull component that adds strength, is chemically bonded with GlassLock™ to the hull and stringers, under tons of pressure. The result is a bond that is stronger than the fiberglass itself, proven far superior to mechanical bonds that other companies use.

Then, 3/8" AnchorLOK™ reinforcement steel plates are laminated into the hull to provide rigid mounting points for the engine, ski pylon, rear lifting rings and the swim platform. Many boat companies mount the engine and other components directly into fiberglass or wood, resulting in stress cracking and inevitable failure.

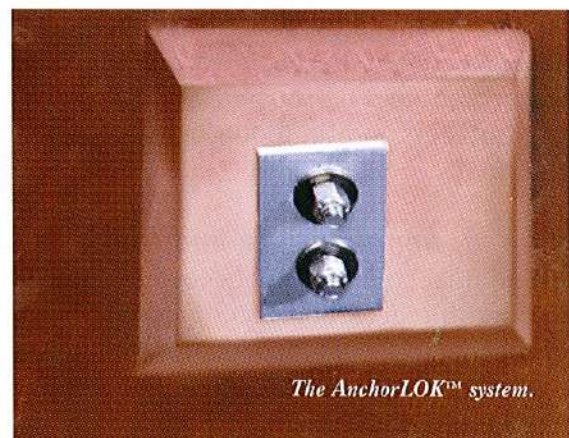

The AnchorLOK™ system.

Step 6: Foam Flotation

After the floor liner is in place, pressurized closed-cell flotation foam is injected into the spaces between the hull and floor liner to produce a solid, rigid, one-piece structure. Foam also deadens noise and provides positive flotation for the boat, which is an added safety feature.

Coast Guard regulations do not require foam in boats over 20', but all MasterCraft models feature foam.

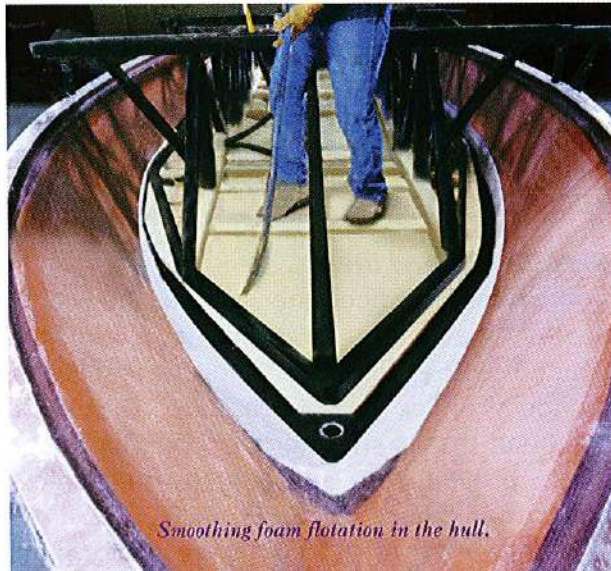

Step 7: Composite Floor Panels/ Drive Train Covers

The next step in the process is to install floors made of composite materials in the hull of the boat to cover the drive train. These units are both strong and lightweight. Unlike wood, they will never warp or rot. This is critical because carpet can absorb water and hold it, causing wood floor panels to start deteriorating long before the rest of the boat.

Step 8: Bonding Deck and Hull

The final step in the LifeMaster™ process is to bond the deck and hull together. The deck is mechanically bonded to the hull with silicone and fasteners for strength, watertightness and durability.

Some companies simply use fasteners to bond the deck and hull together. This can create stress points in the fiberglass. Others use fiberglass to seal the joint, but this can cause problems if there is ever a need to remove the deck for a major repair.

Our system uses stainless steel fasteners that are anchored into a high density polyethylene DuraBak™ backing strip. This takes the pressure off the fiberglass and provides a bond that is exceptionally strong—but can be taken apart if there is ever the need for a major repair.

Small Fiberglass Parts

Like the hull of the boat, all small fiberglass components, such as trailer fenders and motor boxes are constructed of hand-laid fiberglass for strength. A separate manufacturing line is dedicated to these components.

PUTTING THE PIECES TOGETHER

Rigging

On the rigging line, all interior components such as engines, fuel tanks, carpet, upholstery and finish details are hand-installed by skilled craftspeople. Every MasterCraft comes pre-wired for all available options and has a moisture-proof wiring harness.

The order of installation has been carefully choreographed so that parts are never in the way of workers and therefore do not get damaged.



MasterCraft Marine Power Engines by Indmar

The standard engine for 2001 is the Predator, a Vortec 5.7-liter V-8 engine with electronic throttle-body fuel injection. One ride makes it clear how it got its name. For those who want even more power, however, there is also the optional 5.7-liter LTR™. This 330-horsepower, ski-specific, multi-port EFI V-8 is Vortec-based and features an exclusive MasterCraft/Indmar fuel delivery system with an elongated, ski-tuned plenum. It produces jump-up acceleration and an astonishing broad, flat torque curve all the way to wide-open throttle.

Our exclusive EFI Management System™ controls all our engines in three key areas: fuel, spark and air. This system constantly monitors more than 30 engine factors to calculate the optimum performance under any load, in any condition and at any altitude. We program each electronic control module (ECM) to pinpoint the optimal RPMs, fuel quality and coolant temperature needed to give each engine model maximum skiability. If there's a problem, the ECM reacts within microseconds to correct it, or to prevent any further damage to the engine.

That is what makes our engines smarter. But they are tougher too, because of extra quality steps like a waterproof ECM, a seven-step paint process, precision machining of components and crankshaft-driven water pumps. And don't forget, MasterCraft engines come with a three-year warranty.

But we couldn't talk about engines this year and forget the award-winning Cadillac® Northstar®, exclusively available in the MariStar models. The Northstar engine cranks out tons of torque at every speed from idle to full-throttle. However, its torque release is biased toward mid-range situations. Unlike the higher-strung import V-8s, this engine has power exactly where the skier wants it.

This is the first all-American, phased port fuel injection, quad-cam, 32-valve design. Individual injectors deliver precisely calibrated amounts of fuel to each cylinder. A multi-band computer-controlled torque curve matches engine output to boat performance.

Limp-home mode shuts down individual cylinders if the engine ever loses coolant. Each Northstar engine comes standard with a closed cooling system and is mated to MasterCraft's famous 1.5:1 PowerSlot™ transmission.



It's fitting that MasterCraft would team up with Cadillac. And that, of all the boat manufacturers in the world, Cadillac would choose to align itself with MasterCraft and Indmar.

Upholstery

MasterCraft produces its own custom upholstery using multiple layers of high density Cel-Master™ foam, rotocast polyethylene frames and backs (instead of wood), premium vinyl and triple stitching.

MasterCraft uses the highest grade marine vinyl with more than double the surface weight and 20% more tear-resistance than vinyls used on other boats. It is treated with mildew inhibitors and UV-protected triple stitching combined with reinforced backing and heavy-duty UV-protected thread keeps the upholstery together. It has been rigidly tested under all sorts of circumstances to make sure it keeps its color and does not crack, even after years of use. In some places, the vinyl is foam-backed so that it gives a more defined curve around edges and provides a more tailored look.

Our upholsterers are experienced craftspeople. Some have more than 20 years of upholstery experience. And every metal component on a MasterCraft is either stainless steel or other non-corrosive material. Even upholstery staples are marine grade stainless steel. Upholstery has a one-year warranty.

Lake Testing

Every MasterCraft that comes off our assembly line must pass a 30-point quality assurance on-the-water test. A TECH1 analyzer is used to check for engine anomalies and calibrate all gauges. Steps are taken to resolve any issues before the boat can be prepped for shipment.

Final Finish

Although our Ultimate 8000™ gel coat has remarkable luster on its own, every new MasterCraft is carefully cleaned and mirror glazed before it is loaded.

Many of our new owners show up to see their new boat unloaded off the truck, and we want to make sure that it is love at first sight.

Our boats are also shrink-wrapped to keep them clean and carefully loaded onto our own trailers for delivery.

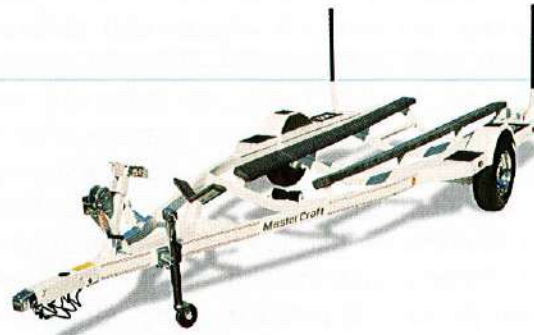

Custom Trailers

MasterCraft trailers are custom-made to precisely fit our ski boats. They are made of tubular steel for strength, with steel reinforced fiberglass fenders.

Trailers are carefully prepped after they are welded together because we think the finish on the trailers is as important as the finish on the boat. All trailers have a two-part polyurethane paint system for a lasting finish. The paint is matched to the base color of the boat.

Here are some other important trailer features:

- Radial tires with custom MasterCraft aluminum rims
- Standard disc brakes on all trailers
- Tandem axle trailers get disc brakes on both axles
- EZ Load system makes it easier to get the boat out of the water
- Standard Bearing Buddy for longer life, less maintenance
- Coiled covered safety cables instead of chains
- Guide bars
- Waterproof lights

**Descriptions
and Information**

about

Individual Models

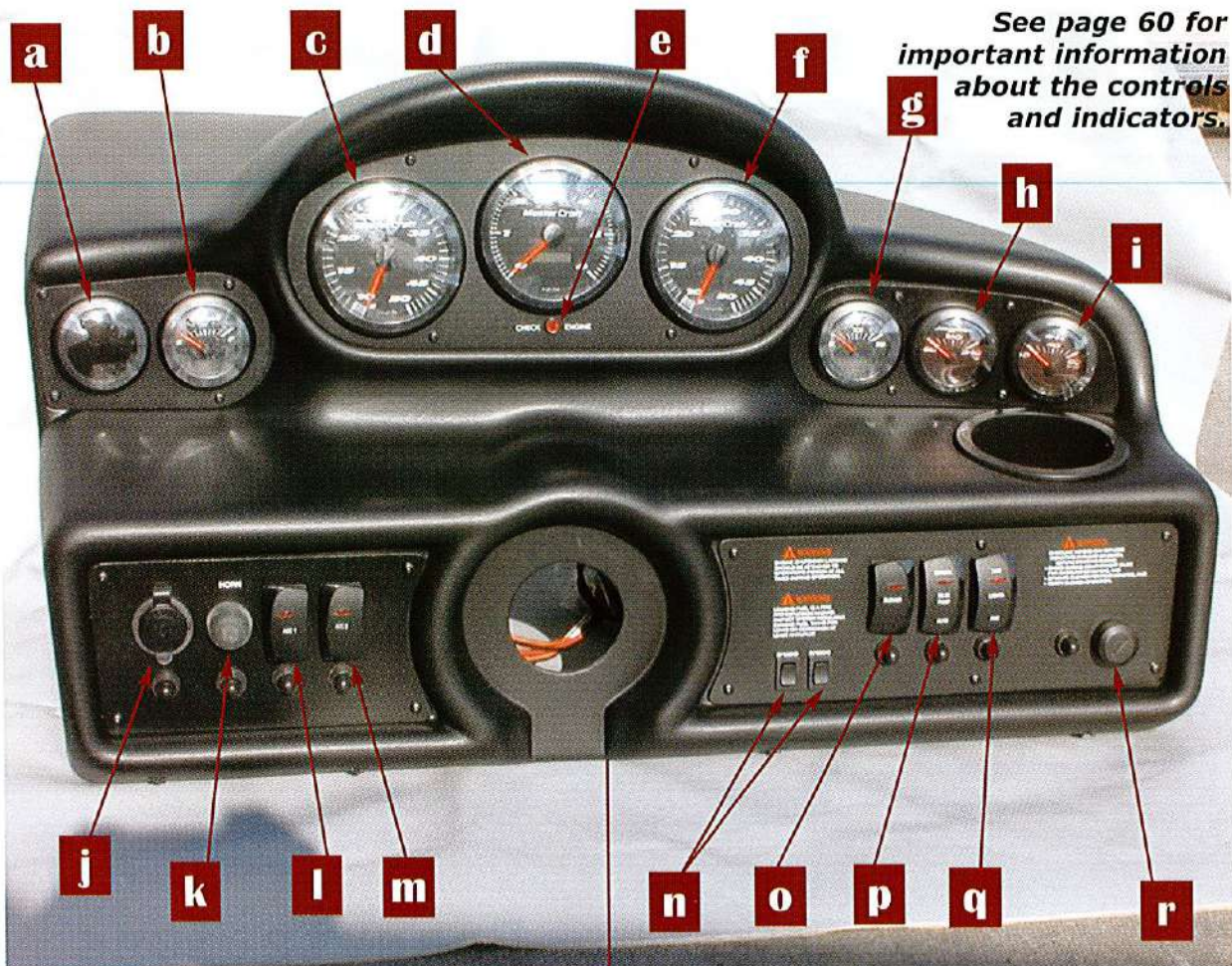

See page 60 for important information about the controls and indicators.

Length of Boat: 19'6"
Width Amidship: 85"
Overall Length w/Trailer: 21'3"
Overall Width w/Trailer: 7'9"
Boat Weight: 2,600 lbs.
Single Axle Trailer Weight: 810 lbs.
Tandem Axle Trailer Weight: 1,050 lbs.
Fuel Capacity: 31 gallons
Depth at Transom: 22"
Depth Amidship: 25"
Draft: 22"
Tow Bar Height to Waterline: 29"
Capacity: 9 persons or 1,440 lbs.

- a — available slot
- b — fuel gauge
- c — speedometer
- d — tachometer
- e — check engine light
- f — speedometer
- g — voltmeter
- h — engine temperature gauge
- i — oil pressure gauge
- j — 12-volt receptacle
- k — horn
- l — accessory 1 switch
- m — accessory 2 switch
- n — speedo adjustment switches
- o — blower switch
- p — bilge pump switch
- q — navigational and anchor lights switch
- r — ignition key slot

19 SKIER LAYOUT

- a — stern light receptacle
- b — blower exhaust
- c — swim platform
- d — fuel tank filler
- e — engine compartment
- f — throttle/shift control
- g — instrument panel
- h — bow light
- i — glove box
- j — battery (under seat)
- k — fire extinguisher (behind seat)
- l — drain plug (in bilge)



19 SKIER STANDARD EQUIPMENT

MasterCraft Power Vortec MX Predator
5.7L TBI EFI 350 cubic inch
GM V-8 engine—310 hp
1:1 gear ratio transmission
3-blade 13-inch propeller
3-year limited engine warranty
Competition throttle control
Dual exhaust system
Dual fuel filtration system
EZ Change oil kit
Fuel gauge
Oil pressure gauge
SilentMaster muffler/exhaust system
Tachometer with hourmeter
Temperature gauge
One 12-volt DC power outlets
Center drain with threaded drain plug
Custom steering wheel,
ergonomically designed
Six drink holders
Driver's seat with rotocast frame,
adjustable fore and aft
Gas-filled motor box lifts
Lockable glove box
Observer's seat, aft-facing
Teak swim platform-removable
Tilt steering wheel
Two-piece insulated motor box
All hand-laid fiberglass construction
All stainless steel and non-corrosive
hardware
AnchorLok reinforcing plates
Bow eye
CelMaster foam seat construction
Circuit breakers
Aluminum floorboards
Cross-linked polyethylene fuel cell
Curved tempered safety glass windshield
Gel coat tolerances to +/- .005"
Heavy-duty marine carpet
with 5-year limited warranty
Integrated gel coat striping
M.O.D.S.—MasterCraft Oscillation
Dampening System
Magnesium bronze rudder
with 1-1/8" stainless steel shaft

Magnesium bronze rudder box with o-rings
and grease fittings
Magnesium bronze strut with 8-bolt
mounting and dual bearings
MasterCraft custom gauges—electro-
mechanical
MasterCraft custom steering connection
with grease fittings
Monocoque integrated stringer system
Neopyentyl glycol/isophthalic gel coat
No-spill gas fill
On-water quality assurance testing
of every boat
Insulated and vented motor box/engine
compartment
Precision Touch rotary steering system
Rigid PVC rubrail with vinyl insert
Stainless steel interior handrails
Stainless steel upholstery staples
Steel-reinforced molds
Stern eyes
Storage under sun deck
Hinged sun deck
Tapered prop shaft coupler with locknut
Transferable hull and structural
components limited lifetime warranty
Wiring harness with color-coded and
labeled wires
Automatic/manual bilge pump system
Bilge blower
Engine warning light
Fire extinguisher
Flotation meeting USCG requirements
Horn
Inland lighting
NMMA-certified for safety
Safety engine stop switch
AWSA Approved
Adjustable oversized windshield mounted
convex mirror w/bracket, removable
Anodized aluminum ski pylon
Tournament speedometers (two)
Three tracking fins
Transom ski tow eye
Wear-Guard ski pylon, patented

19 SKIER OPTIONAL EQUIPMENT

MasterCraft Power Vortec MX LT-R 5.7L multi-port EFI 350 cubic inch GM V-8 engine—330 hp
1.5:1 gear ratio patented PowerSlot package (includes 4-blade 14x18 prop)
Closed cooling system (not available with shower)
European-certified package
Bimini top (dealer installed)
Boat cover
Sun top (dealer installed)
Drop-in carpeted floormat (dealer installed)
Boat house cradle—galvanized
Fiberglass swim platform—ivory or white
Depth finder
Heater
Clarion AM/FM CD stereo system with 4 marine speakers
Clarion AM/FM CD stereo system with subwoofer and high power amp
Wireless headphone system
Six-disc CD changer
Perfect Pass Pro Series
Perfect Pass cruise control
Perfect Pass Wakeboard
Pressurized hot/cold shower (not available with closed cooling system)

Extended warranty
Tournament KPH speedometers (two—no charge option)
ZeroFlex Flyer
ZeroFlex Flyer boat cover
Tower lights
Tower speakers
Two board racks (holds four boards)
Metal flake gel coat
Transom saver
Master View driver's seat
MTS
Bow pull-up cleats
Stern pull-up cleats
Smart plug with alarm
High-volume air pump
Binding Blaster Soap Pump
Single axle trailer with disc brakes
Tandem axle trailer with disc brakes
Galvanized single axle trailer with disc brakes
Galvanized tandem axle trailer with disc brakes
Pivot tongue on trailer, standard
Spare trailer tire—aluminum or galvanized
Canadian trailer specifications

See page 60 for important information about the controls and indicators.

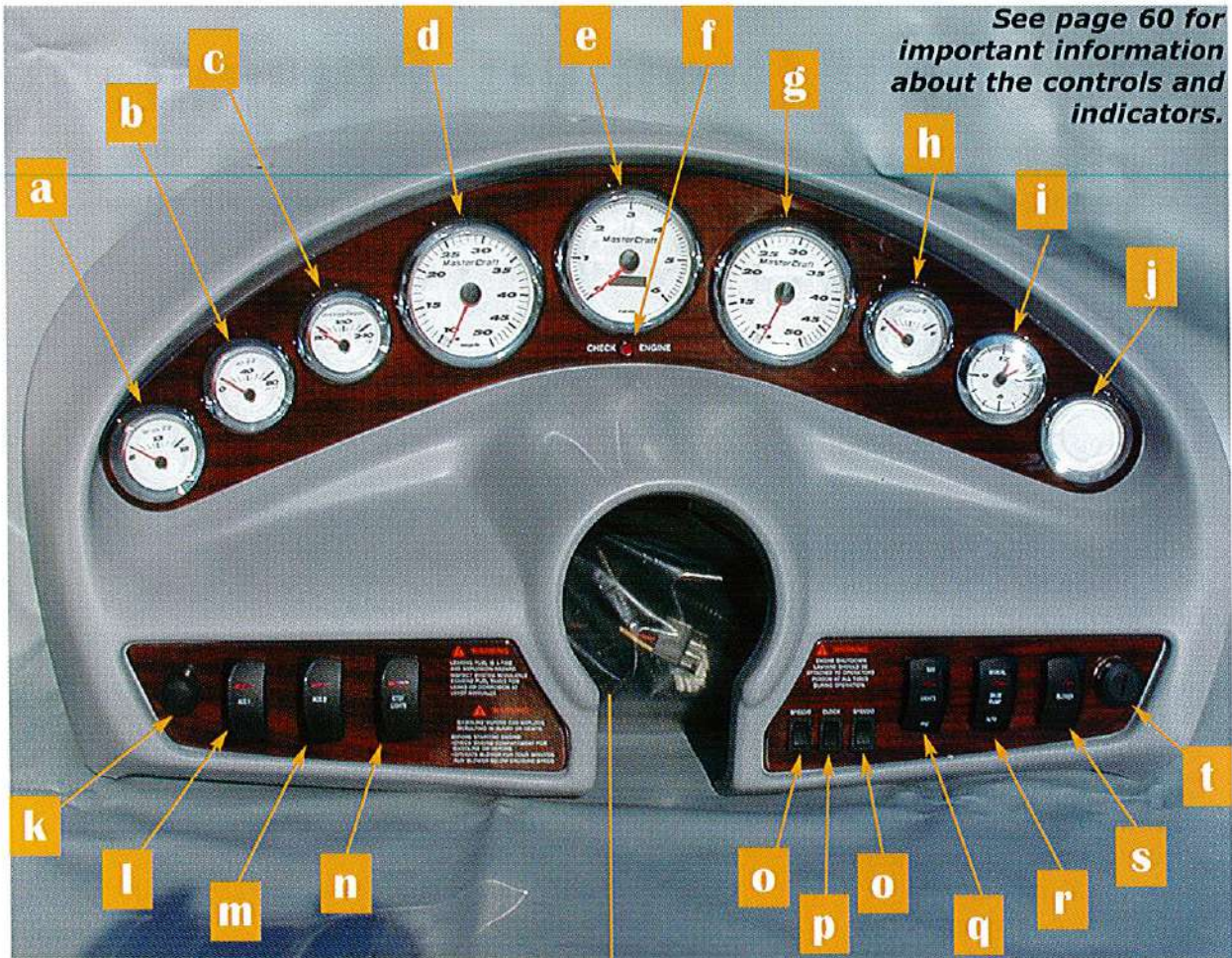

Length of Boat: 19'6"
Width Amidship: 85"
Overall Length w/Trailer: 23'
w/pivot tongue folded: 21'3"
Overall Width w/Trailer: 7'9"
Boat Weight: 2,540 lbs.
Single Axle Trailer Weight: 810 lbs.
Tandem Axle Trailer Weight: 1,050 lbs.
Fuel Capacity: 31 gallons
Depth at Transom: 21 1/2"
Depth Amidship: 26"
Draft: 22"
Tow Bar Height to Waterline: 29"
Capacity: 10 persons or 1,355 lbs.

- a — voltmeter
- b — oil pressure gauge
- c — engine temperature gauge
- d — speedometer
- e — tachometer
- f — check engine light
- g — speedometer
- h — fuel gauge
- i — clock
- j — available slot
- k — horn
- l — accessory 1
- m — accessory 2
- n — courtesy lights switch
- o — speedo adjustment switches
- p — clock adjustment switch
- q — navigational and anchor lights switch
- r — bilge pump switch
- s — blower
- t — ignition key slot

PROSTAR 195 LAYOUT

- a — stern light receptacle
- b — blower exhaust
- c — swim platform
- d — fuel tank filler
- e — storage under sun pad
- f — engine compartment
- g — throttle/shift control
- h — instrument panel
- i — bow light
- j — glove box
- k — battery (under seat)
- l — fire extinguisher (behind seat)
- m — drain plug (in bilge)

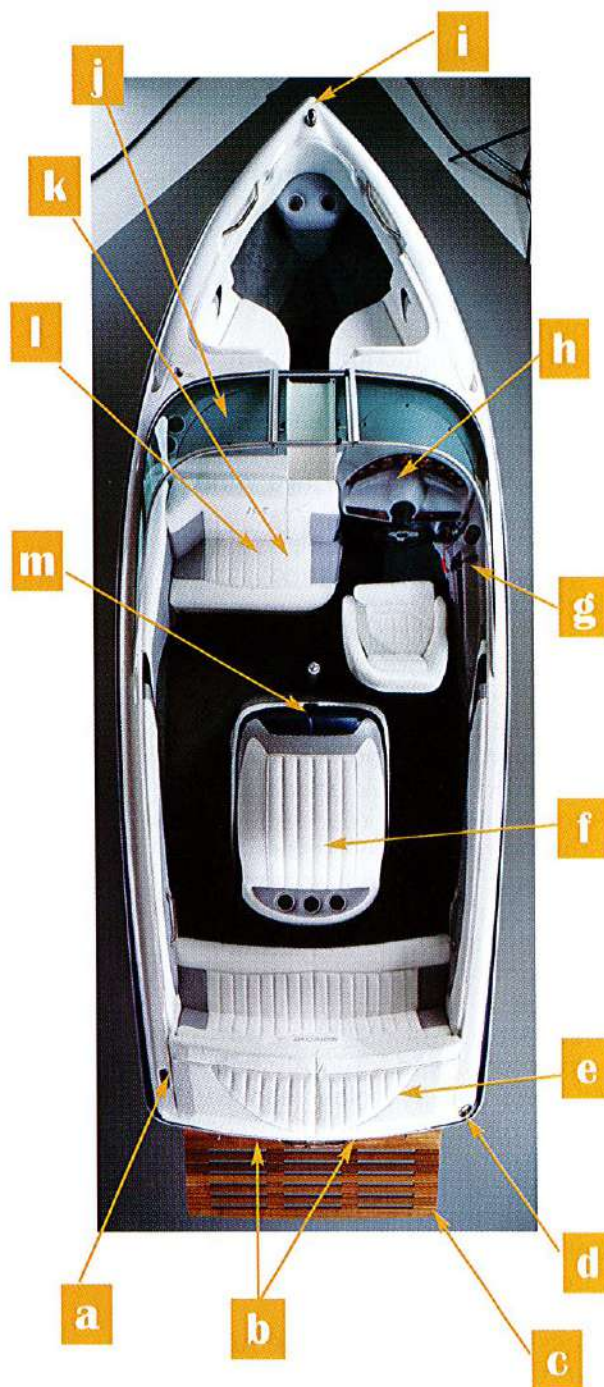

PROSTAR 195 STANDARD EQUIPMENT

MasterCraft Power Vortec MX Predator
5.7L TBI EFI 350 cubic inch
GM V-8 engine—310 hp
1:1 gear ratio transmission
4-blade 13-inch propeller
3-year limited engine warranty
Competition throttle control
Dual exhaust system
Dual fuel filtration system
EZ Change oil kit
Fuel gauge
High-pressure in-tank fuel pump
Oil pressure gauge
SilentMaster muffler/exhaust system
Tachometer with hourmeter
Engine temperature gauge
Voltmeter
Venturi air induction system
Two 12-volt DC power outlets
Center drain with threaded drain plug
Chronograph clock
Companionway walk-thru wind enclosure,
canvas
Custom steering wheel,
ergonomically designed
Eight drink holders
Driver's seat with rotocast frame,
adjustable fore and aft
Gas-filled motor box lifts
Lockable glove box
Observer's seat, aft-facing
Rear storage trunk under sunpad, lighted
Removable lower rear seat cushion
Storage under bow seating
Sun pad, hinged full access
Teak swim platform, removable
Tilt steering wheel
Transom handrail with integral tow loop
Two-piece insulated motor box
Water-resistant glovebox with space
for stereo and integral shelf, lockable
All hand-laid fiberglass construction
All stainless steel and non-corrosive
hardware
AnchorLok reinforcing plates
Bow eye
CelMaster foam seat construction
Circuit breakers
Aluminum floorboards
Cross-linked polyethylene fuel cell
Curved tempered safety glass windshield
Gel coat tolerances to +/- .005"

Heavy-duty marine carpet
with 5-year limited warranty
Integrated gel coat striping
M.O.D.S.—MasterCraft Oscillation
Dampening System
Magnesium bronze rudder
with 1-1/8" stainless steel shaft
Magnesium bronze rudder box with o-rings
and grease fittings
Magnesium bronze strut with 8-bolt
mounting and dual bearings
MasterCraft electro-mechanical
custom gauges
MasterCraft custom steering connection
with grease fittings
Monocoque integrated stringer system
Neopentyl glycol/isophthalic gel coat
No-spill gas fill
On-water quality assurance testing
of every boat
Insulated and vented motor box/engine
compartment
Precision Touch II rack and pinion system
Rigid PVC rubrail with vinyl insert
Stainless steel interior handrails
Stainless steel upholstery staples
Steel-reinforced molds
Stern eyes
Tapered prop shaft coupler with locknut
Transferable hull and structural
components limited lifetime warranty
Wiring harness with color-coded and
labeled wires
Automatic/manual bilge pump system
Bilge blower
Engine warning light
Fire extinguisher
Flotation meeting USCG requirements
Horn
Inland lighting
NMMA-certified for safety
Safety engine stop switch
AWSA Approved
Adjustable oversized windshield mounted
convex mirror w/bracket, removable
Anodized aluminum ski pylon
Fold-down center seat for walk-thru
Side panel ski storage with netting
Tournament speedometers (two)
Three tracking fins
Transom ski tow eye
Wear-Guard ski pylon, patented

PROSTAR 195 OPTIONAL EQUIPMENT

MasterCraft Power Vortec MX LT-R 5.7L multi-port EFI 350 cubic inch GM V-8 engine—330 hp
1.5:1 gear ratio patented PowerSlot package (includes 4-blade 14x18 prop)
Closed cooling system (not available with shower)
European-certified package
Bimini top (dealer installed)
Boat cover
Bow tonneau cover (dealer installed)
Cockpit mooring cover (dealer installed)
Sun top (dealer installed)
Drop-in carpeted floormat (dealer installed)
Boat house cradle—galvanized
Fiberglass swim platform—removable, ivory or white
Raised platform
Depth finder
Heater
Clarion AM/FM CD stereo system with 4 marine speakers, removable faceplate
Clarion stereo remote control on instrument panel, included with Clarion AM/FM CD stereo option
Wireless headphone system
Six-disc CD changer
Perfect Pass Pro Series
Perfect Pass cruise control
Perfect Pass Wakeboard
Pressurized hot/cold shower (not available with closed cooling system)

Extended warranty
Tournament KPH speedometers (two—no charge option)
ZeroFlex Flyer
ZeroFlex Flyer boat cover
Tower lights
Two board racks (holds four boards)
Transom saver
Metal flake gel coat
Reverse gel coat
Rearrangement of gel coat colors
Rearrangement of upholstery colors
Back Stop Rope Deflection System
Water temperature gauge
Master View driver's seat
Rear ballast system
Bow pull-up cleats
Stern pull-up cleats
Smart drain plug with alarm
High-volume air pump
Binding Blaster Soap Pump
Small stripe
Single axle trailer with disc brakes
Tandem axle trailer with disc brakes
Galvanized single axle trailer with disc brakes
Galvanized tandem axle trailer with disc brakes
Pivot tongue on trailer, standard
Spare trailer tire—aluminum or galvanized
Canadian trailer specifications

See page 60 for important information about the controls and indicators.

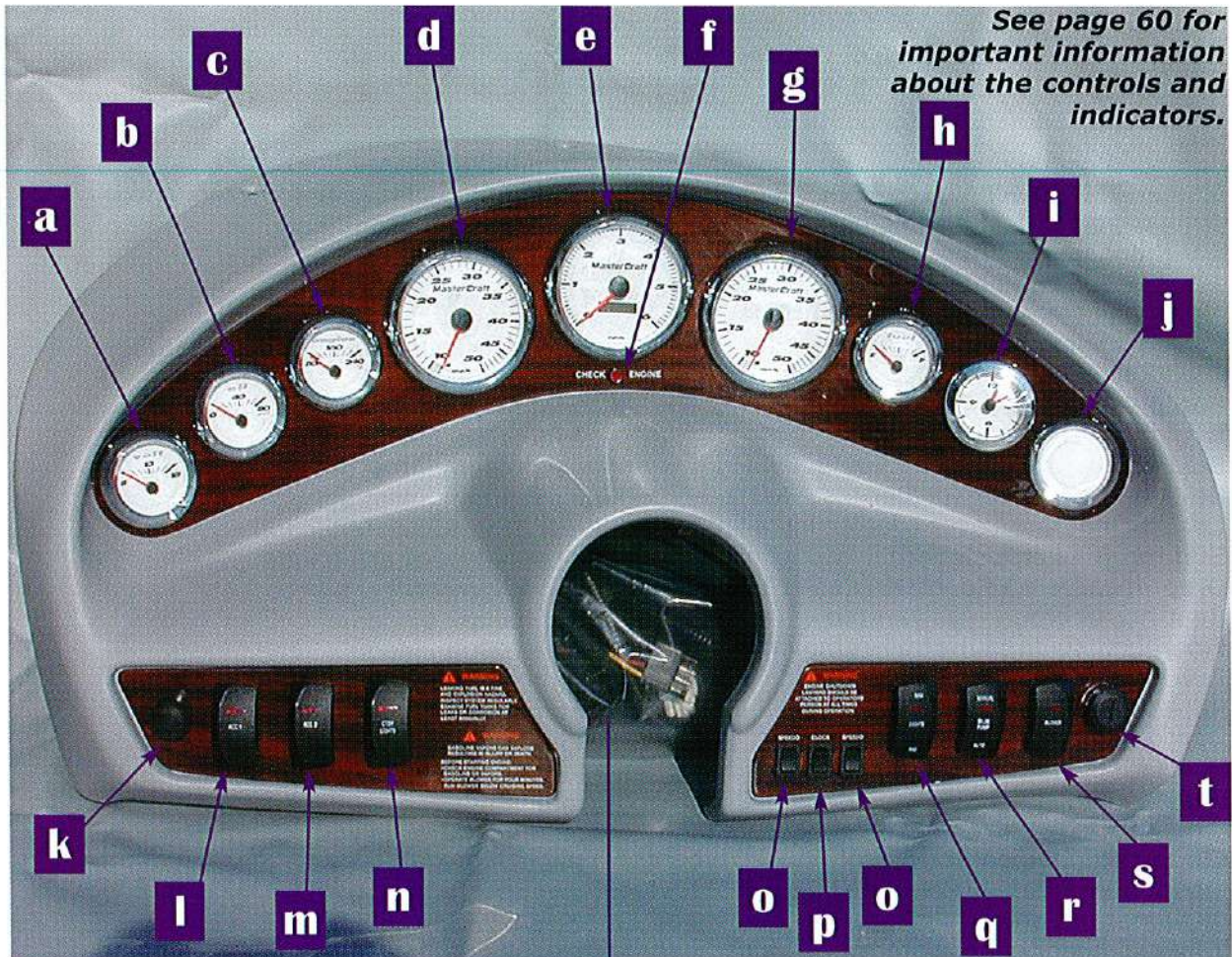

Length of Boat: 19'8"
Width Amidship: 91"
Overall Length w/Trailer: 22'9"
w/pivot tongue folded: 21'
Overall Width w/Trailer: 93 3/4"
Boat Weight: 2,620 lbs. (approx.)
Single Axle Trailer Weight: 860 lbs.
Tandem Axle Trailer Weight: 1,040 lbs.
Fuel Capacity: 28 gallons
Depth at Transom: 20"
Depth Amidship: 22 1/2"
Draft: 22"
Tow Bar Height to Waterline: 29"
Capacity: 10 persons or 1,340 lbs.

- a — voltmeter
- b — oil pressure gauge
- c — engine temperature gauge
- d — speedometer
- e — tachometer
- f — check engine light
- g — speedometer
- h — fuel gauge
- i — clock
- j — available slot
- k — horn
- l — accessory 1
- m — accessory 2
- n — courtesy lights switch
- o — speedo adjustment switches
- p — clock adjustment switch
- q — navigational and anchor lights switch
- r — bilge pump switch
- s — blower
- t — ignition key slot

PROSTAR 190 EVO LAYOUT

- a — fuel tank filler
- b — blower exhaust
- c — swim platform
- d — stern light receptacle
- e — storage under sun pad
- f — engine compartment
- g — throttle/shift control
- h — instrument panel
- i — bow light
- j — glove box
- k — battery (under seat)
- l — fire extinguisher (behind seat)
- m — drain plug (in bilge)

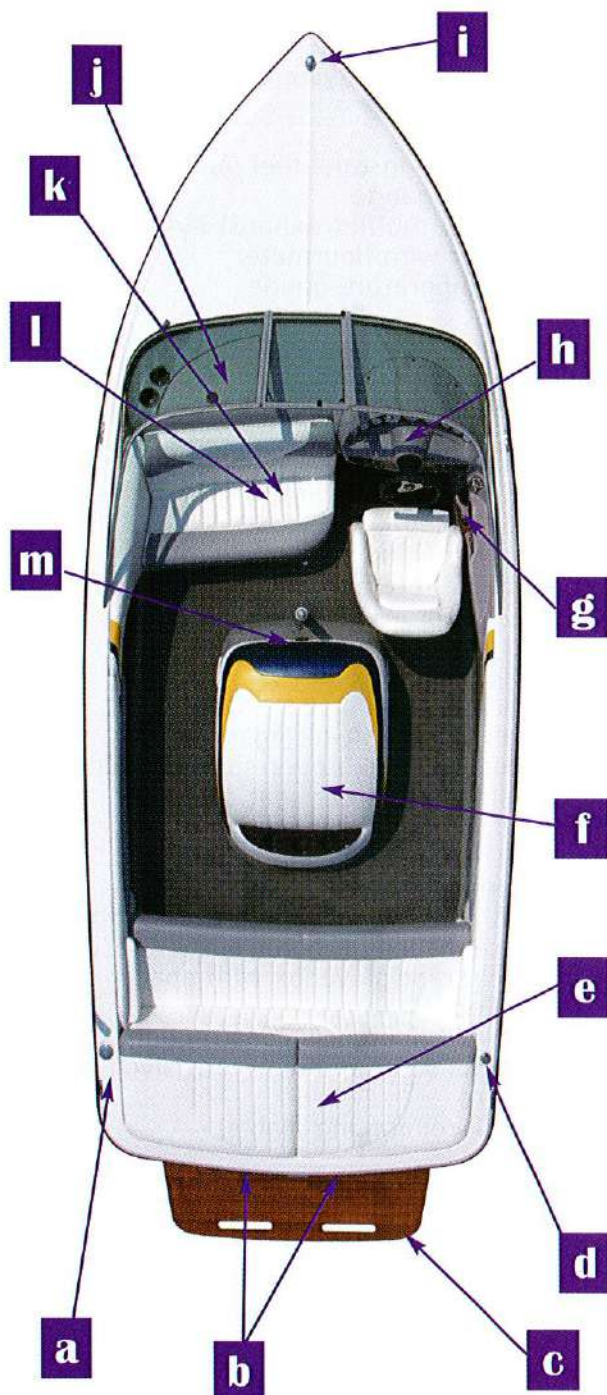

PROSTAR 190 EVO STANDARD EQUIPMENT

MasterCraft Power Vortec MX Predator
5.7L TBI EFI 350 cubic inch
GM V-8 engine—310 hp
1:1 gear ratio transmission
4-blade 13-inch propeller
3-year limited engine warranty
Competition throttle control
Dual exhaust system
Dual fuel filtration system
EZ Change oil kit
Fuel gauge
High-pressure in-tank fuel pump
Oil pressure gauge
SilentMaster muffler/exhaust system
Tachometer with hourmeter
Engine temperature gauge
Voltmeter
Two 12-volt DC power outlets
Built-in cooler with drain
Center drain with threaded drain plug
Chronograph clock
Custom steering wheel,
ergonomically designed
Six drink holders
Driver's seat with rotocast frame,
adjustable fore and aft
Gas-filled motor box lifts
Lighted bow storage
Lockable glove box
Lockable observer's seat storage
Observer's seat, aft-facing
Rear storage trunk under sunpad—lighted
Removable lower rear seat cushion
Sun pad, hinged full access
Teak swim platform, removable
Tilt steering wheel
Transom handrail with integral tow loop
Two-piece insulated motor box
Water-resistant glovebox with space
for stereo, lockable
All hand-laid fiberglass construction
All stainless steel and non-corrosive
hardware
AnchorLok reinforcing plates
Bow eye
CelMaster foam seat construction
Circuit breakers
Aluminum floorboards
Cross-linked polyethylene fuel cell
Curved tempered safety glass windshield
Gel coat tolerances to +/- .005"
Heavy-duty marine carpet
with 5-year limited warranty

Integrated gel coat striping
Modified epoxy resin—exclusive to
MasterCraft
M.O.D.S.—MasterCraft Oscillation
Dampening System
Magnesium bronze rudder
with 1-1/8" stainless steel shaft
Magnesium bronze rudder box with o-rings
and grease fittings
Magnesium bronze strut with 8-bolt
mounting and dual bearings
MasterCraft electro-mechanical
custom gauges
MasterCraft custom steering connection
with grease fittings
Monocoque integrated stringer system
Neopyentyl glycol/isophthalic gel coat
No-spill gas fill
On-water quality assurance testing
of every boat
Insulated and vented motor box/engine
compartment
Precision Touch II rack and pinion system
Rigid PVC rubrail with vinyl insert
Stainless steel interior handrails
Stainless steel upholstery staples
Steel-reinforced molds
Stern eyes
Tapered prop shaft coupler with locknut
Transferable hull and structural
components limited lifetime warranty
Wiring harness with color-coded and
labeled wires
Automatic/manual bilge pump system
Bilge blower
Engine warning light
Fire extinguisher
Flotation meeting USCG requirements
Horn
Inland lighting
NMMA-certified for safety
Safety engine stop switch
AWSA Approved
Adjustable oversized windshield mounted
convex mirror w/bracket, removable
Anodized aluminum ski pylon
New hull
Side panel ski storage
Tournament speedometers (two)
Three tracking fins
Transom ski tow eye
Wear-Guard ski pylon, patented

PROSTAR 190 EVO OPTIONAL EQUIPMENT

MasterCraft Power Vortec MX LT-R 5.7L multi-port EFI 350 cubic inch GM V-8 engine—330 hp
1.5:1 gear ratio patented PowerSlot package (includes 4-blade 14x18 prop)
Closed cooling system (not available with shower)
European-certified package
Bimini top (dealer installed)
Boat cover
New Back Stop Rope Deflection System
Cockpit mooring cover (dealer installed)
Sun top (dealer installed)
Drop-in carpeted floormat (dealer installed)
Boat house cradle—galvanized
Fiberglass swim platform—removable, ivory or white
Depth finder
Heater
Clarion AM/FM CD stereo system with 4 marine speakers, with remote
Clarion AM/FM CD stereo system with subwoofer and high power amp
Clarion stereo remote control on instrument panel, included with Clarion AM/FM CD stereo option
Wireless headphone system
Six-disc CD changer
Perfect Pass Pro Series
Perfect Pass cruise control
Perfect Pass Wakeboard
Pressurized hot/cold shower (not available with closed cooling system)

Extended warranty
Tournament KPH speedometers (two—no charge option)
ZeroFlex Flyer
ZeroFlex Flyer and boat cover
Tower lights
Tower speakers
Two board racks (holds four boards)
Transom saver
Custom upholstery
Metal flake gel coat
Reverse gel coat
Rearrangement of gel coat colors
Rearrangement of upholstery colors
Water temperature gauge
MasterView driver's seat
MTS
Bow pull-up cleats
Stern pull-up cleats
Smart drain plug with alarm
High-volume air pump
Binding Blaster Soap Pump
Small stripe
Single axle trailer with disc brakes
Tandem axle trailer with disc brakes
Galvanized single axle trailer with disc brakes
Galvanized tandem axle trailer with disc brakes
Pivot tongue on trailer, standard
Spare trailer tire—aluminum or galvanized
Canadian trailer specifications

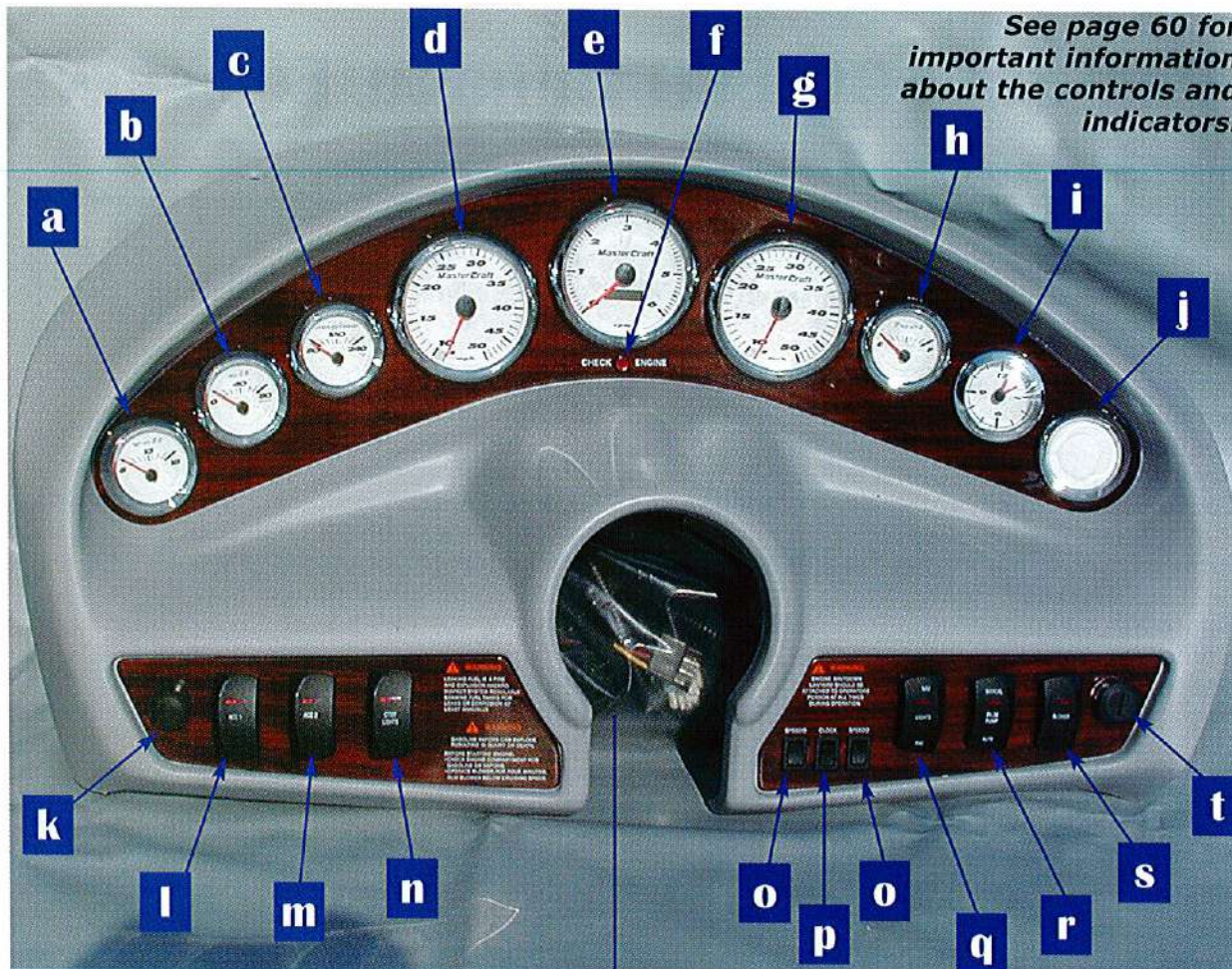

See page 60 for important information about the controls and indicators.

Length of Boat: 20"11 1/2"
Width Amidship: 96"
Overall Length w/Trailer: 23'
w/pivot tongue folded: 21'4"
Overall Width w/Trailer: 96"
Boat Weight: 2,850 lbs.
Single Axle Trailer Weight: 860 lbs.
Tandem Axle Trailer Weight: 1,040 lbs.
Fuel Capacity: 35 gallons
Depth at Transom: 23"
Depth Amidship: 25 1/2"
Draft: 22"
Tow Bar Height to Waterline: 29"
Capacity: 12 persons or 1,705 lbs.

- a — voltmeter
- b — oil pressure gauge
- c — engine temperature gauge
- d — speedometer
- e — tachometer
- f — check engine light
- g — speedometer
- h — fuel gauge
- i — clock
- j — available slot
- k — horn
- l — accessory 1
- m — accessory 2
- n — courtesy lights switch
- o — speedo adjustment switches
- p — clock adjustment switch
- q — navigational and anchor lights switch
- r — bilge pump switch
- s — blower
- t — ignition key slot

PROSTAR 209 LAYOUT

- a — fuel tank filler
- b — blower exhaust
- c — swim platform
- d — stern light receptacle
- e — storage under sun pad
- f — engine compartment
- g — throttle/shift control
- h — instrument panel
- i — bow light
- j — glove box
- k — battery (under seat)
- l — fire extinguisher (behind seat)
- m — drain plug (in bilge)



PROSTAR 209 STANDARD EQUIPMENT

MasterCraft Power Vortec MX Predator
5.7L TBI EFI 350 cubic inch
GM V-8 engine—310 hp
1:1 gear ratio transmission
4-blade 13-inch propeller
3-year limited engine warranty
Competition throttle control
Dual exhaust system
Dual fuel filtration system
EZ Change oil kit
Fuel gauge
High-pressure in-tank fuel pump
Oil pressure gauge
SilentMaster muffler/exhaust system
Tachometer with hourmeter
Engine temperature gauge
Voltmeter
Two 12-volt DC power outlets
Center drain with threaded drain plug
Chronograph clock
Companionway walk-thru wind enclosure,
canvas
Custom steering wheel,
ergonomically designed
Eight drink holders
Bolster driver's seat with rotocast frame,
adjustable fore and aft
Gas-filled motor box lifts
Lockable glove box
Observer's seat, aft-facing
Rear storage trunk under sunpad
Removable lower rear seat cushion
Storage under bow seating
Sun pad, hinged full access
Teak swim platform, removable
Tilt steering wheel
Transom handrail with integral tow loop
Two-piece insulated motor box
Water-resistant glovebox with space
for stereo, lockable
All hand-laid fiberglass construction
All stainless steel and non-corrosive
hardware
AnchorLok reinforcing plates
Bow eye
CelMaster foam seat construction
Circuit breakers
Aluminum floorboards
Cross-linked polyethylene fuel cell
Curved tempered safety glass windshield
Gel coat tolerances to +/- .005"

Heavy-duty marine carpet
with 5-year limited warranty
Integrated gel coat striping
M.O.D.S.—MasterCraft Oscillation
Dampening System
Magnesium bronze rudder
with 1-1/8" stainless steel shaft
Magnesium bronze rudder box with o-rings
and grease fittings
Magnesium bronze strut with 8-bolt
mounting and dual bearings
MasterCraft electro-mechanical
custom gauges
MasterCraft custom steering connection
with grease fittings
Monocoque integrated stringer system
Neopyentyl glycol/isophthalic gel coat
No-spill gas fill
On-water quality assurance testing
of every boat
Insulated and vented motor box/engine
compartment
Precision Touch II rack and pinion system
Rigid PVC rubrail with vinyl insert
Stainless steel interior handrails
Stainless steel upholstery staples
Stern eyes
Tapered prop shaft coupler with locknut
Transferable hull and structural
components limited lifetime warranty
Wiring harness with color-coded and
labeled wires
Automatic/manual bilge pump system
Bilge blower
Engine warning light
Fire extinguisher
Flotation meeting USCG requirements
Horn
Inland lighting
NMMA-certified for safety
Safety engine stop switch
AWSA Approved
Adjustable oversized windshield mounted
convex mirror w/bracket, removable
Anodized aluminum ski pylon
Center ski storage locker and cooler
Side panel ski storage
Tournament speedometers (two)
Three tracking fins
Wear-Guard ski pylon, patented

PROSTAR 209 OPTIONAL EQUIPMENT

- MasterCraft Power Vortec MX LT-R 5.7L multi-port EFI 350 cubic inch GM V-8 engine—330 hp
- 1.5:1 gear ratio patented PowerSlot package (includes 4-blade 14x18 prop)
- Closed cooling system (not available with shower)
- European-certified package
- Bimini top (dealer installed)
- Boat cover
- Bow tonneau cover (dealer installed)
- Cockpit mooring cover (dealer installed)
- Sun top (dealer installed)
- Drop-in carpeted floormat (dealer installed)
- Boat house cradle—galvanized
- Fiberglass swim platform—removable, ivory or white
- Depth finder
- Heater
- Clarion AM/FM CD stereo system with 4 marine speakers, stereo remote control
- Clarion AM/FM CD stereo system with subwoofer and high power amp
- Wireless headphone system
- Six-disc CD changer
- Perfect Pass Pro Series
- Perfect Pass cruise control
- Perfect Pass Wakeboard
- Pressurized hot/cold shower (not available with closed cooling system)
- Extended warranty
- Tournament KPH speedometers (two—no charge option)
- Removable center seat for walk-thru
- ZeroFlex Flyer
- ZeroFlex Flyer boat cover
- Tower lights
- Tower speakers
- Two board racks (holds four boards)
- Transom saver
- Metal flake gel coat
- Reverse gel coat
- Rearrangement of gel coat colors
- Rearrangement of upholstery colors
- Back Stope Rope Deflector
- Water temperature gauge
- Bow filler cushion
- Bow pull-up cleats
- Stern pull-up cleats
- Smart drain plug with alarm
- High-volume air pump
- Binding Blaster Soap Pump
- Small stripe
- Single axle trailer with disc brakes
- Tandem axle trailer with disc brakes
- Galvanized single axle trailer with disc brakes
- Galvanized tandem axle trailer with disc brakes
- Pivot tongue on trailer, standard
- Spare trailer tire—aluminum or galvanized
- Canadian trailer specifications

See page 60 for important information about the controls and indicators.

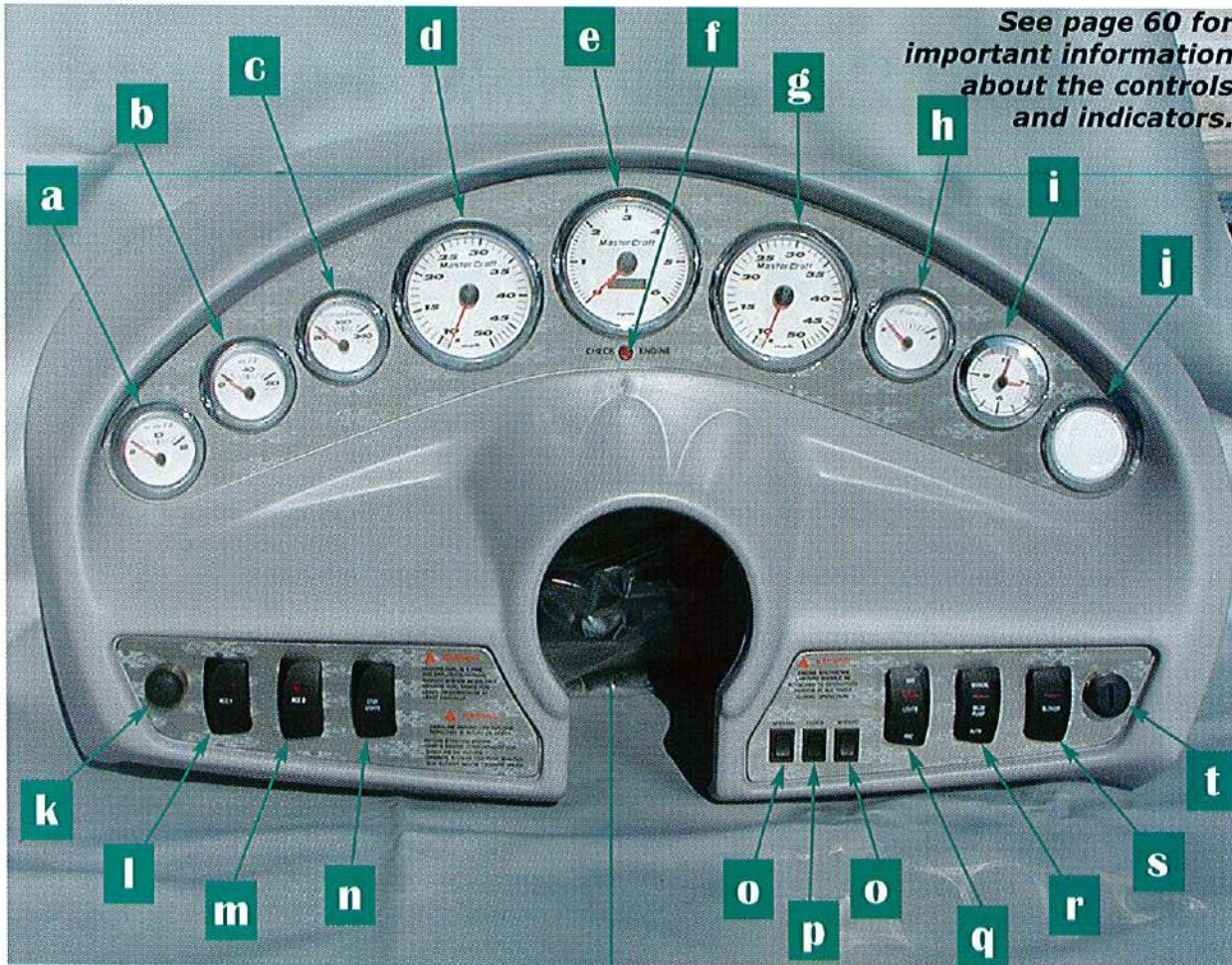

Length of Boat: 20'7"
Width Amidship: 90"
Overall Length w/Trailer: 22'8"
Overall Width w/Trailer: 8'
Boat Weight: 3,050 lbs.
Single Axle Trailer Weight: 860 lbs.
Tandem Axle Trailer Weight: 1,040 lbs.
Fuel Capacity: 29 gallons
Depth at Transom: 23 1/2"
Depth Amidship: 25 1"
Draft: 22"
Tow Bar Height to Waterline: 29"
Capacity: 12 persons or 1,720 lbs.

- a — voltmeter
- b — oil pressure gauge
- c — engine temperature gauge
- d — speedometer
- e — tachometer
- f — check engine light
- g — speedometer
- h — fuel gauge
- i — clock
- j — available slot
- k — horn
- l — accessory 1
- m — accessory 2
- n — courtesy lights switch
- o — speedo adjustment switches
- p — clock adjustment switch
- q — navigational and anchor lights switch
- r — bilge pump switch
- s — blower
- t — ignition key slot

X-5 LAYOUT

- a — stern light receptacle
- b — blower exhaust
- c — swim platform
- d — fuel tank filler
- e — storage under sun pad
- f — engine compartment
- g — throttle/shift control
- h — instrument panel
- i — bow light
- j — glove box
- k — battery (under seat)
- l — fire extinguisher (behind seat)
- m — drain plug (in bilge)

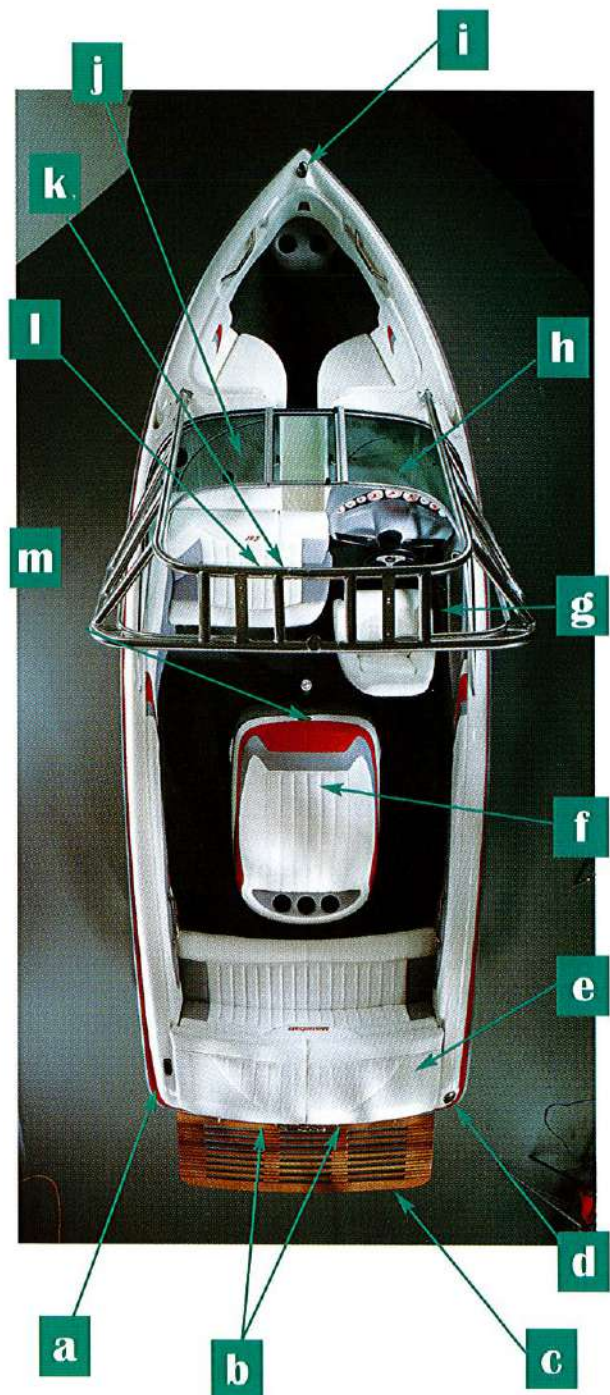

X-5 STANDARD EQUIPMENT

X-5 Package: tower, stereo w/remote, ballast system, monograms, decal kit, raised platform, transom saver
5.7L TBI EFI 350 cubic inch GM V-8 engine—310 hp
1.5:1 gear ratio transmission
4-blade 14-inch propeller
3-year limited engine warranty
Competition throttle control
Dual exhaust system
Dual fuel filtration system
EZ Change oil kit
Fuel gauge
High-pressure in-tank fuel pump
Oil pressure gauge
SilentMaster muffler/exhaust system
Tachometer with hourmeter
Temperature gauge
Venturi air induction system
Two 12-volt DC power outlets
Chronograph clock
Companionway walk-thru wind enclosure, canvas
Custom steering wheel, ergonomically designed
Nine drink holders
Bolster driver's seat with rotocast frame, adjustable fore and aft
Lockable glove box
Observer's seat, aft-facing
Rear storage trunk under sun pad—lighted
Storage under bow seating
3-piece sun pad
Teak swim platform, removable
Tilt steering wheel
Transom drain plug
Transom handrail with integral tow loop
Water-resistant glovebox with space for stereo and integral shelf, lockable
All hand-laid fiberglass construction
All stainless steel and non-corrosive hardware
AnchorLok reinforcing plates
Bow eye
CelMaster foam seat construction
Circuit breakers
Aluminum floorboards
Cross-linked polyethylene fuel cell
Curved tempered safety glass windshield
Gel coat tolerances to +/- .005"
Heavy-duty marine carpet

with 5-year limited warranty
Integrated gel coat striping
M.O.D.S.—MasterCraft Oscillation Dampening System
Magnesium bronze rudder with 1-1/8" stainless steel shaft
Magnesium bronze rudder box with o-rings and grease fittings
Magnesium bronze strut with 8-bolt mounting and dual bearings
MasterCraft electro-mechanical custom gauges
MasterCraft custom steering connection with grease fittings
Monocoque integrated stringer system
Neopyentyl glycol/isophthalic gel coat
No-spill gas fill
On-water quality assurance testing of every boat
Insulated and vented engine compartment
Precision Touch II rack and pinion system
Rigid PVC rubrail with vinyl insert
Stainless steel interior handrails
Stainless steel upholstery staples
Steel-reinforced molds
Stern eyes
Tapered prop shaft coupler with locknut
Transferable hull and structural components limited lifetime warranty
Wiring harness with color-coded and labeled wires
Automatic/manual bilge pump system
Bilge blower
Engine warning light
Fire extinguisher
Flotation meeting USCG requirements
Horn
Inland lighting
NMMA-certified for safety
Safety engine stop switch
Adjustable oversized windshield mounted convex mirror w/bracket, removable
Anodized aluminum ski pylon
Center ski storage locker
Tournament speedometers (two)
Three tracking fins
Wear-Guard ski pylon, patented

X-5 OPTIONAL EQUIPMENT

MasterCraft Power Vortec MX LT-R 5.7L multi-port EFI 350 cubic inch GM V-8 engine—330 hp
Closed cooling system (not available with shower)
European-certified package
Bimini top (dealer installed)
Boat cover
Bow tonneau cover (dealer installed)
Cockpit mooring cover (dealer installed)
Sun top (dealer installed)
Drop-in carpeted floormat (dealer installed)
Boat house cradle—galvanized
Fiberglass swim platform—removable, ivory or white
Raised platform
Depth finder
Heater
Clarion AM/FM CD stereo system with 4 marine speakers, removable faceplate
Clarion AM/FM CD stereo system with subwoofer and high power amp
Clarion stereo remote control on instrument panel, included with Clarion AM/FM CD stereo option
Wireless headphone system
Six-disc CD changer
Perfect Pass Pro Series
Perfect Pass cruise control
Perfect Pass Wakeboard
Pressurized hot/cold shower (not available with closed cooling system)

Extended warranty
Tournament KPH speedometers (two—no charge option)
Removable center seat for walk-thru
Cockpit table
ZeroFlex Flyer
ZeroFlex Flyer and boat cover
Tower lights
Tower speakers
Two board racks (holds four boards)
Metal flake gel coat
Reverse gel coat
Rearrangement of gel coat colors
Rearrangement of upholstery colors
Water temperature gauge
Walk-thru seat (ivory or white)
Bow filler cushion
Bow pull-up cleats
Stern pull-up cleats
Smart plug with alarm
High-volume air pump
Binding Blaster Soap Pump
Single axle trailer with disc brakes
Tandem axle trailer with disc brakes
Galvanized single axle trailer with disc brakes
Galvanized tandem axle trailer with disc brakes
Pivot tongue on trailer, standard
Spare trailer tire—aluminum or galvanized
Canadian trailer specifications

See page 60 for important information about the controls and indicators.

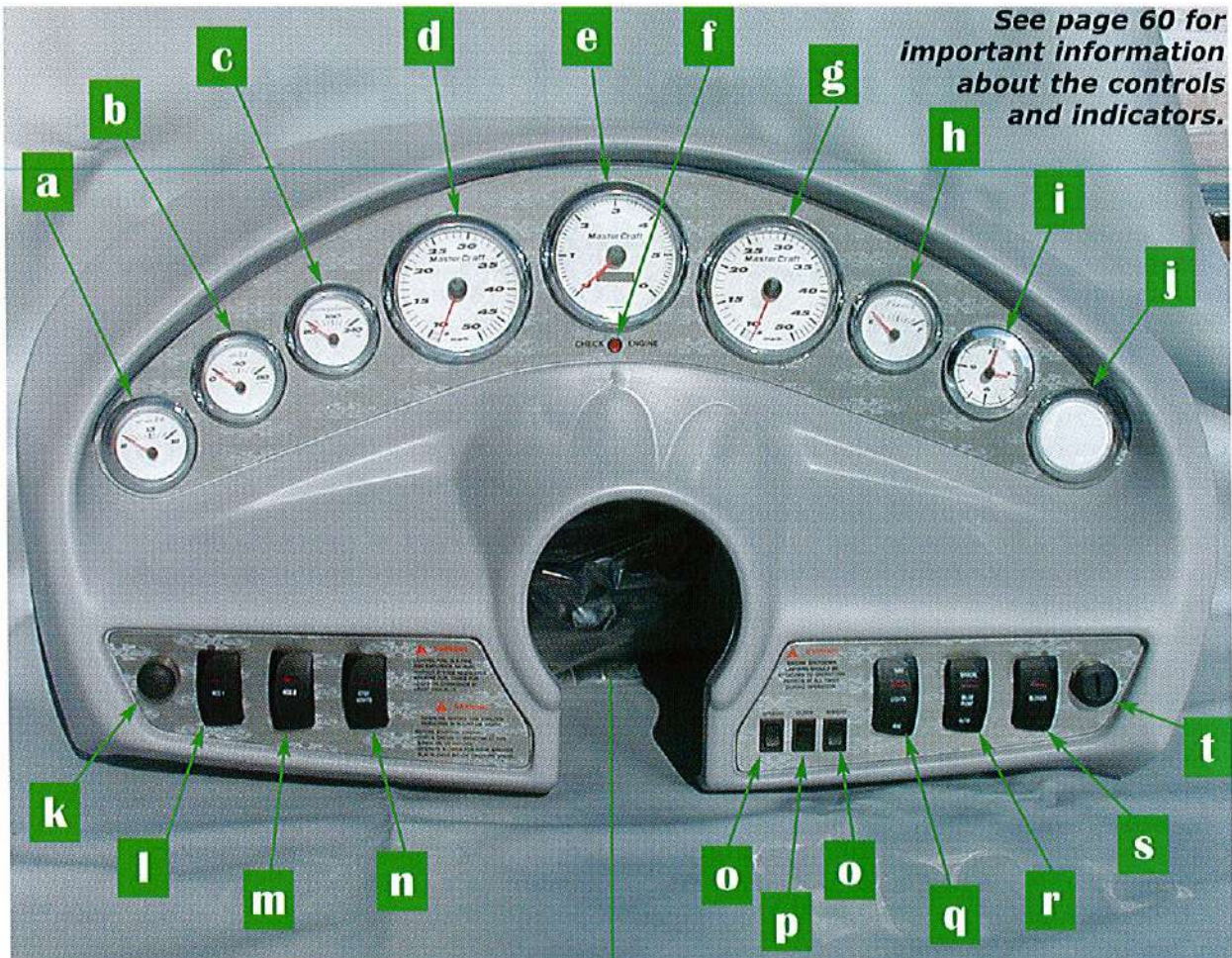

Length of Boat: 20"11 1/2"
Width Amidship: 96"
Overall Length w/Trailer: 23'
w/pivot tongue folded: 21'4"
Overall Width w/Trailer: 96"
Boat Weight: 2,850 lbs.
Single Axle Trailer Weight: 860 lbs.
Tandem Axle Trailer Weight: 1,040 lbs.
Fuel Capacity: 35 gallons
Depth at Transom: 23"
Depth Amidship: 25 1/2"
Draft: 22"
Tow Bar Height to Waterline: 29"
Capacity: 12 persons or 1,705 lbs.

- a — voltmeter
- b — oil pressure gauge
- c — engine temperature gauge
- d — speedometer
- e — tachometer
- f — check engine light
- g — speedometer
- h — fuel gauge
- i — clock
- j — available slot
- k — horn
- l — accessory 1
- m — accessory 2
- n — courtesy lights switch
- o — speedo adjustment switches
- p — clock adjustment switch
- q — navigational and anchor lights switch
- r — bilge pump switch
- s — blower
- t — ignition key slot

X-9 LAYOUT

- a — fuel tank filler
- b — blower exhaust
- c — swim platform
- d — stern light receptacle
- e — storage under sun pad
- f — engine compartment
- g — throttle/shift control
- h — instrument panel
- i — bow light
- j — glove box
- k — battery (under seat)
- l — fire extinguisher (behind seat)
- m — drain plug (in bilge)

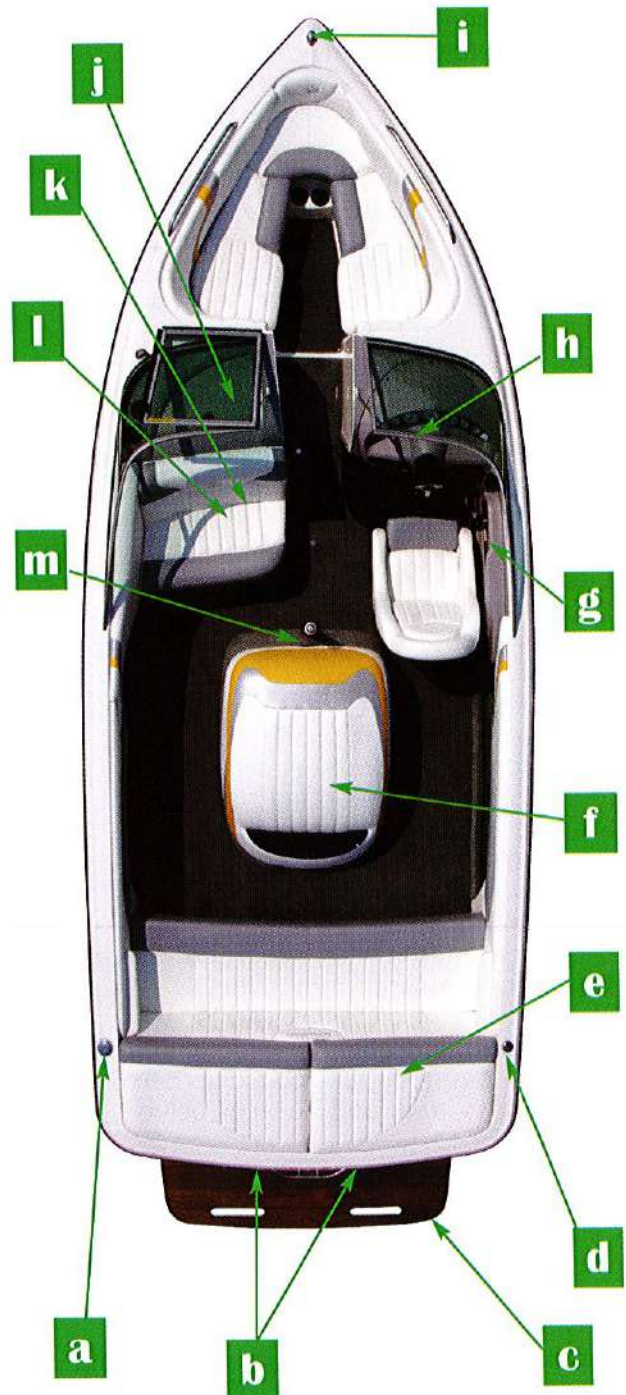

Due to the unavailability of an overhead picture of the X-9 at press time, a ProStar 209 was used due to the similarity in placement of components.

X-9 STANDARD EQUIPMENT

MasterCraft Power Vortec MX Predator
5.7L TBI EFI 350 cubic inch
GM V-8 engine—310 hp
1:1 gear ratio transmission
4-blade 13-inch propeller
3-year limited engine warranty
Competition throttle control
Dual exhaust system
Dual fuel filtration system
EZ Change oil kit
Fuel gauge
High-pressure in-tank fuel pump
Oil pressure gauge
SilentMaster muffler/exhaust system
Tachometer with hourmeter
Engine temperature gauge
Voltmeter
Two 12-volt DC power outlets
Center drain with threaded drain plug
Chronograph clock
Companionway walk-thru wind enclosure,
canvas
Custom steering wheel,
ergonomically designed
Eight drink holders
Bolster driver's seat with rotocast frame,
adjustable fore and aft
Gas-filled motor box lifts
Lockable glove box
Observer's seat, aft-facing
Rear storage trunk under sunpad
Removable lower rear seat cushion
Storage under bow seating
Sun pad, hinged full access
Teak swim platform, removable
Tilt steering wheel
Transom handrail with integral tow loop
Two-piece insulated motor box
Water-resistant glovebox with space
for stereo, lockable
All hand-laid fiberglass construction
All stainless steel and non-corrosive
hardware
AnchorLok reinforcing plates
Bow eye
CelMaster foam seat construction
Circuit breakers
Aluminum floorboards
Cross-linked polyethylene fuel cell
Curved tempered safety glass windshield
Gel coat tolerances to +/- .005"

Heavy-duty marine carpet
with 5-year limited warranty
Integrated gel coat striping
M.O.D.S.—MasterCraft Oscillation
Dampening System
Magnesium bronze rudder
with 1-1/8" stainless steel shaft
Magnesium bronze rudder box with o-rings
and grease fittings
Magnesium bronze strut with 8-bolt
mounting and dual bearings
MasterCraft electro-mechanical
custom gauges
MasterCraft custom steering connection
with grease fittings
Monocoque integrated stringer system
Neopyentyl glycol/isophthalic gel coat
No-spill gas fill
On-water quality assurance testing
of every boat
Insulated and vented motor box/engine
compartment
Precision Touch II rack and pinion system
Rigid PVC rubrail with vinyl insert
Stainless steel interior handrails
Stainless steel upholstery staples
Stern eyes
Tapered prop shaft coupler with locknut
Transferable hull and structural
components limited lifetime warranty
Wiring harness with color-coded and
labeled wires
Automatic/manual bilge pump system
Bilge blower
Engine warning light
Fire extinguisher
Flotation meeting USCG requirements
Horn
Inland lighting
NMMA-certified for safety
Safety engine stop switch
AWSA Approved
Adjustable oversized windshield mounted
convex mirror w/bracket, removable
Anodized aluminum ski pylon
Center ski storage locker and cooler
Side panel ski storage
Tournament speedometers (two)
Three tracking fins
Wear-Guard ski pylon, patented

X-9 OPTIONAL EQUIPMENT

MasterCraft Power Vortec MX LT-R 5.7L multi-port EFI 350 cubic inch GM V-8 engine—330 hp
1.5:1 gear ratio patented PowerSlot package (includes 4-blade 14x18 prop)
Closed cooling system (not available with shower)
European-certified package
Bimini top (dealer installed)
Boat cover
Bow tonneau cover (dealer installed)
Cockpit mooring cover (dealer installed)
Sun top (dealer installed)
Drop-in carpeted floormat (dealer installed)
Boat house cradle—galvanized
Fiberglass swim platform—removable, ivory or white
Depth finder
Heater
Clarion AM/FM CD stereo system with 4 marine speakers, stereo remote control
Clarion AM/FM CD stereo system with subwoofer and high power amp
Wireless headphone system
Six-disc CD changer
Perfect Pass Pro Series
Perfect Pass cruise control
Perfect Pass Wakeboard
Pressurized hot/cold shower (not available with closed cooling system)
Extended warranty

Tournament KPH speedometers (two—no charge option)
Removable center seat for walk-thru
ZeroFlex Flyer
ZeroFlex Flyer boat cover
Tower lights
Tower speakers
Two board racks (holds four boards)
Transom saver
Metal flake gel coat
Reverse gel coat
Rearrangement of gel coat colors
Rearrangement of upholstery colors
Back Stope Rope Deflector
Water temperature gauge
Bow filler cushion
Bow pull-up cleats
Stern pull-up cleats
Smart drain plug with alarm
High-volume air pump
Binding Blaster Soap Pump
Small stripe
Single axle trailer with disc brakes
Tandem axle trailer with disc brakes
Galvanized single axle trailer with disc brakes
Galvanized tandem axle trailer with disc brakes
Pivot tongue on trailer, standard
Spare trailer tire—aluminum or galvanized
Canadian trailer specifications

See page 60 for important information about the controls and indicators.

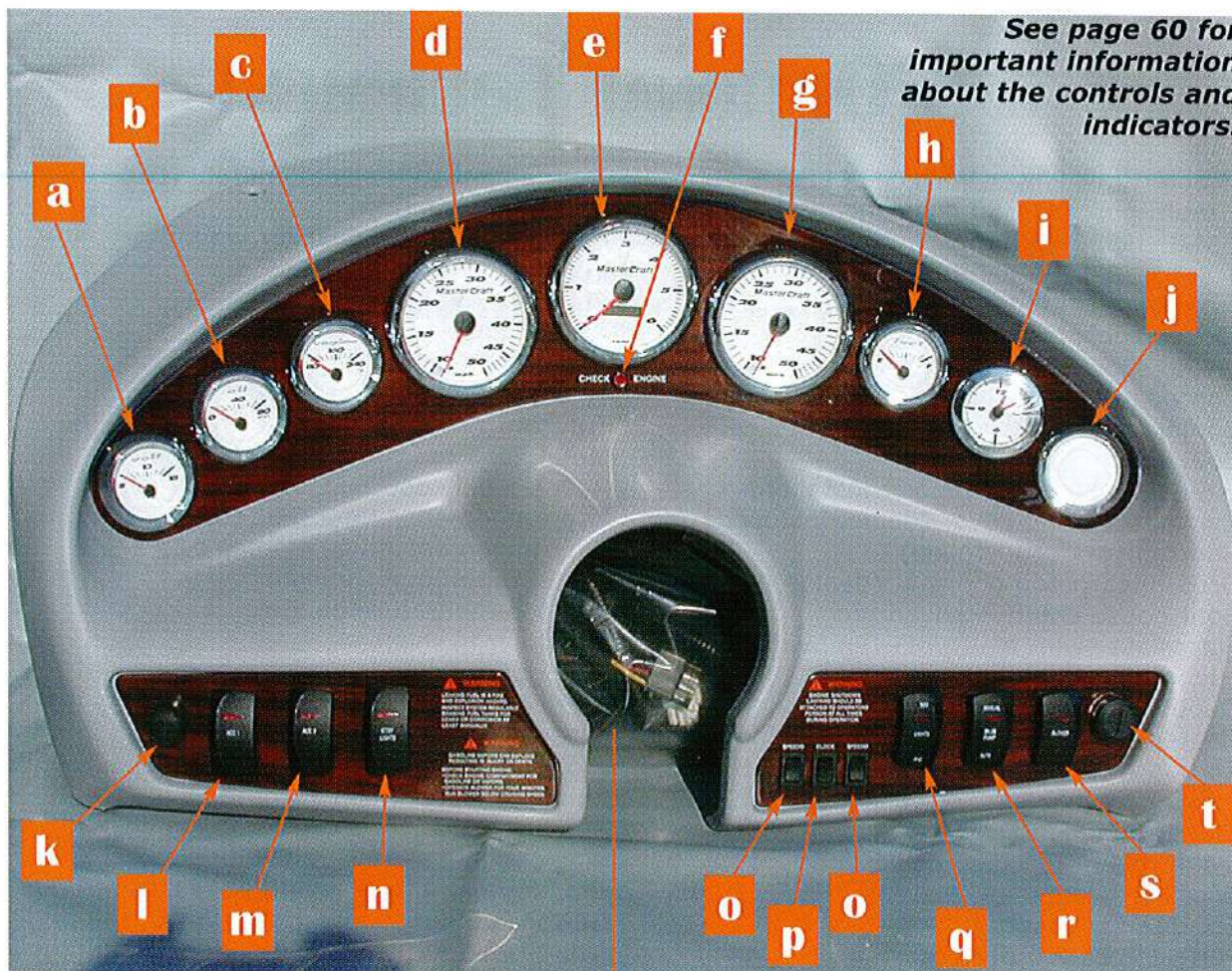

Length of Boat: 20'7"
Width Amidship: 90"
Overall Length w/Trailer: 22'8"
Overall Width w/Trailer: 8'
Boat Weight: 3,050 lbs.
Single Axle Trailer Weight: 860 lbs.
Tandem Axle Trailer Weight: 1,040 lbs.
Fuel Capacity: 29 gallons
Depth at Transom: 23 1/2"
Depth Amidship: 25 1"
Draft: 22"
Tow Bar Height to Waterline: 29"
Capacity: 12 persons or 1,720 lbs.

- a — voltmeter
- b — oil pressure gauge
- c — engine temperature gauge
- d — speedometer
- e — tachometer
- f — check engine light
- g — speedometer
- h — fuel gauge
- i — clock
- j — available slot
- k — horn
- l — accessory 1
- m — accessory 2
- n — courtesy lights switch
- o — speedo adjustment switches
- p — clock adjustment switch
- q — navigational and anchor lights switch
- r — bilge pump switch
- s — blower
- t — ignition key slot

PROSTAR 205 VRS LAYOUT

- a — stern light receptacle
- b — blower exhaust
- c — swim platform
- d — storage under sun pad
- e — fuel tank filler
- f — engine compartment
- g — throttle/shift control
- h — instrument panel
- i — bow light
- j — glove box
- k — battery (under seat)
- l — fire extinguisher (behind seat)
- m — ski locker

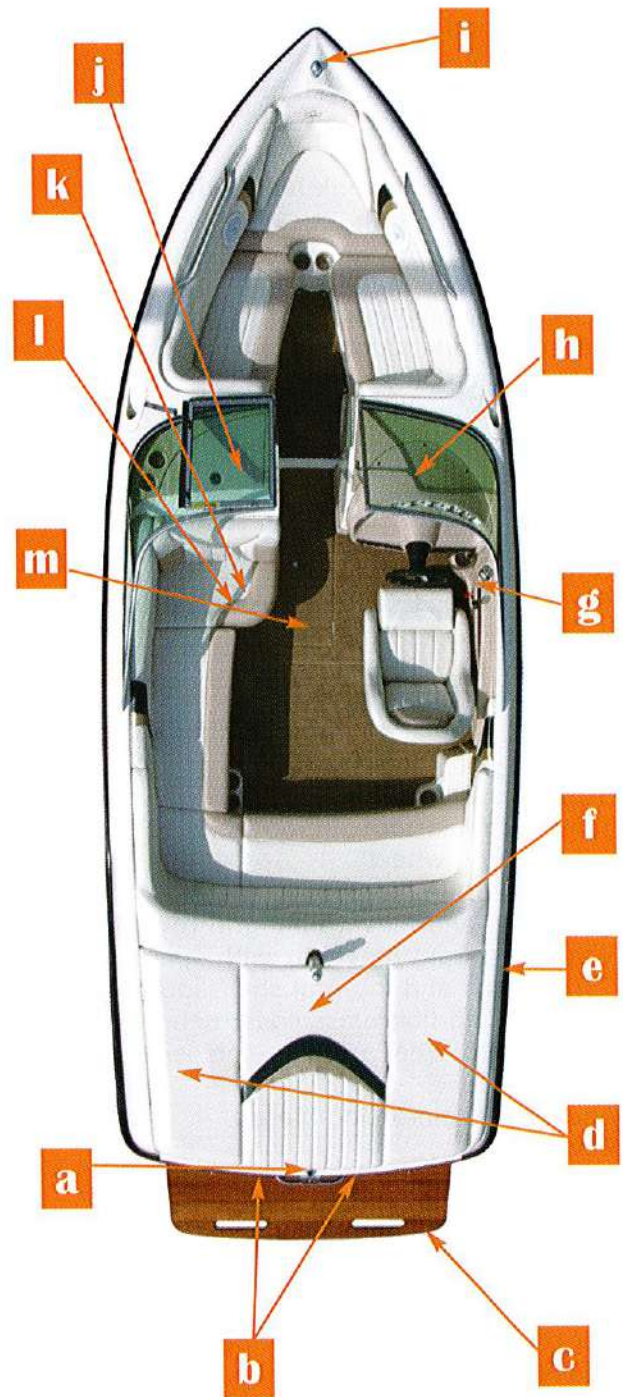

PROSTAR 205VRS STANDARD EQUIPMENT

MasterCraft Power Vortec MX Predator
5.7L TBI EFI 350 cubic inch
GM V-8 engine—310 hp
1.5:1 gear ratio transmission
4-blade 14-inch propeller
3-year limited engine warranty
Competition throttle control
Dual exhaust system
Dual fuel filtration system
EZ Change oil kit
Fuel gauge
High-pressure in-tank fuel pump
Oil pressure gauge
SilentMaster muffler/exhaust system
Tachometer with hourmeter
Temperature gauge
Venturi air induction system
Two 12-volt DC power outlets
Chronograph clock
Companionway walk-thru wind enclosure,
canvas
Custom steering wheel,
ergonomically designed
Nine drink holders
Bolster driver's seat with rotocast frame,
adjustable fore and aft
Lockable glove box
Observer's seat, aft-facing
Rear storage trunk under sunpad—lighted
Storage under bow seating
3-piece sun pad
Teak swim platform, removable
Tilt steering wheel
Transom drain plug
Transom handrail with integral tow loop
Water-resistant glovebox with space
for stereo and integral shelf, lockable
All hand-laid fiberglass construction
All stainless steel and non-corrosive
hardware
AnchorLok reinforcing plates
Bow eye
CelMaster foam seat construction
Circuit breakers
Aluminum floorboards
Cross-linked polyethylene fuel cell
Curved tempered safety glass windshield
Gel coat tolerances to +/- .005"
Heavy-duty marine carpet
with 5-year limited warranty

Integrated gel coat striping
Low-profile polyester resin
M.O.D.S.—MasterCraft Oscillation
Dampening System
Magnesium bronze rudder
with 1-1/8" stainless steel shaft
Magnesium bronze rudder box with o-rings
and grease fittings
Magnesium bronze strut with 8-bolt
mounting and dual bearings
MasterCraft electro-mechanical
custom gauges
MasterCraft custom steering connection
with grease fittings
Monocoque integrated stringer system
Neopyentyl glycol/isophthalic gel coat
No-spill gas fill
On-water quality assurance testing
of every boat
Insulated and vented engine
compartment
Precision Touch II rack and pinion system
Rigid PVC rubrail with vinyl insert
Stainless steel interior handrails
Stainless steel upholstery staples
Steel-reinforced molds
Stern eyes
Tapered prop shaft coupler with locknut
Transferable hull and structural
components limited lifetime warranty
Wiring harness with color-coded and
labeled wires
Automatic/manual bilge pump system
Bilge blower
Engine warning light
Fire extinguisher
Flotation meeting USCG requirements
Horn
Inland lighting
NMMA-certified for safety
Safety engine stop switch
Adjustable oversized windshield mounted
convex mirror w/bracket, removable
Anodized aluminum ski pylon
Center ski storage locker
Tournament speedometers (two)
Three tracking fins
Wear-Guard ski pylon, patented

PROSTAR 205VRS OPTIONAL EQUIPMENT

MasterCraft Power Vortec MX LT-R 5.7L multi-port EFI 350 cubic inch GM V-8 engine—330 hp	Tournament KPH speedometers (two—no charge option)
Closed cooling system (not available with shower)	Removable center seat for walk-thru ZeroFlex Flyer
European-certified package	ZeroFlex Flyer boat cover
Bimini top (dealer installed)	Tower lights
Boat cover	Tower speakers
Bow tonneau cover (dealer installed)	Two board racks (holds four boards)
Cockpit mooring cover (dealer installed)	Transom saver
Sun top (dealer installed)	Custom upholstery
Drop-in carpeted floormat (dealer installed)	Metal flake gel coat
Boat house cradle—galvanized	Reverse gel coat
Fiberglass swim platform—removable, ivory or white	Rearrangement of gel coat colors
Raised platform	Rearrangement of upholstery colors
Depth finder	Water temperature gauge
Heater	Walk-thru seat (ivory or white)
Clarion AM/FM CD stereo system with 4 marine speakers, removable faceplate	Bow filler cushion
Clarion AM/FM CD stereo system with subwoofer and high power amp	KGB Ballast System
Clarion stereo remote control on instrument panel, included with Clarion AM/FM CD stereo option	Double ballast system
Wireless headphone system	Bow pull-up cleats
Six-disc CD changer	Stern pull-up cleats
Perfect Pass Pro Series	Smart plug with alarm
Perfect Pass cruise control	High-volume air pump
Perfect Pass Wakeboard	Binding Blaster Soap Pump
Pressurized hot/cold shower (not available with closed cooling system)	Single axle trailer with disc brakes
Extended warranty	Tandem axle trailer with disc brakes
	Galvanized single axle trailer with disc brakes
	Galvanized tandem axle trailer with disc brakes
	Pivot tongue on trailer, standard
	Spare trailer tire—aluminum or galvanized
	Canadian trailer specifications

See page 60 for important information about the controls and indicators.

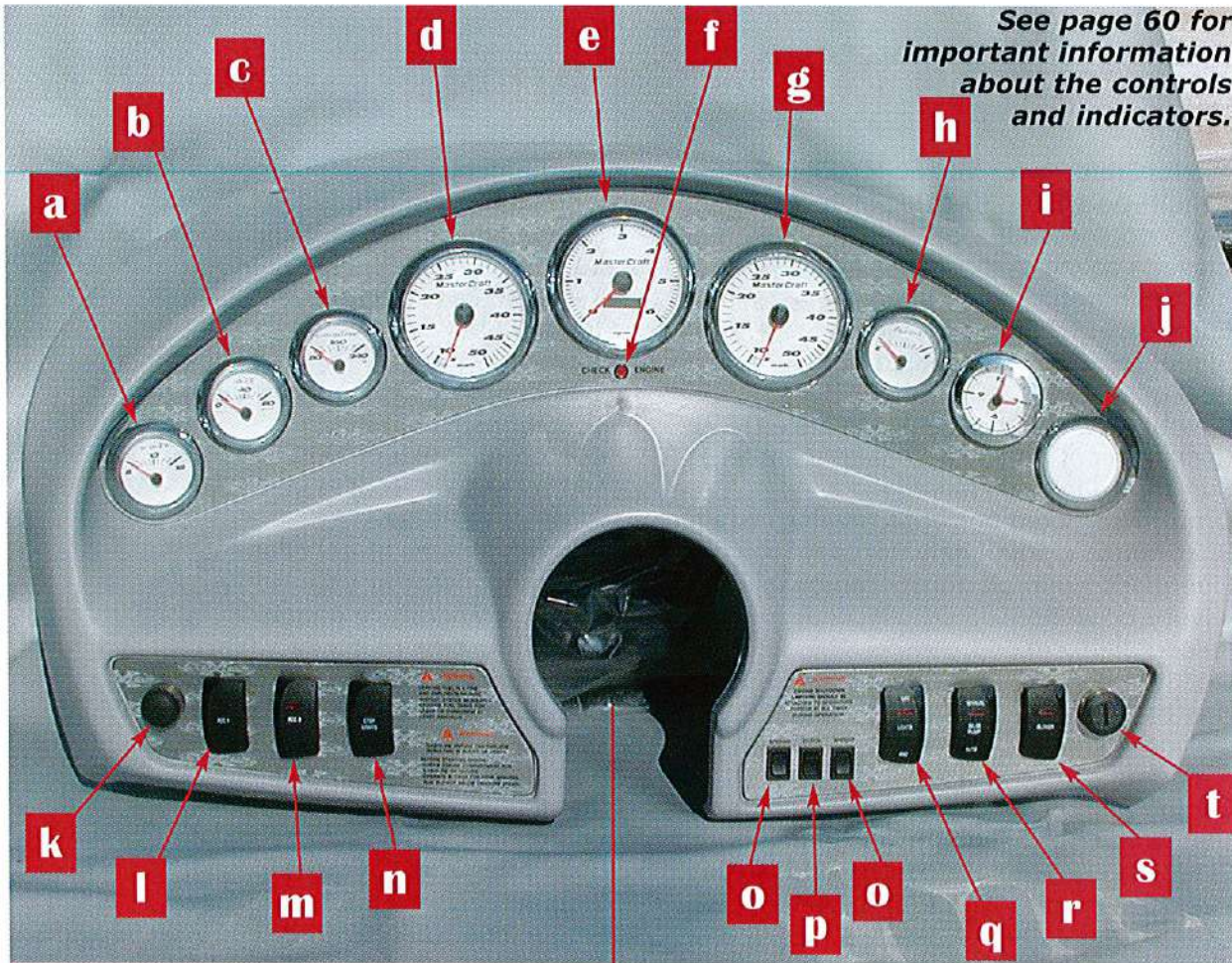

Length of Boat: 20'7"
Width Amidship: 90"
Overall Length w/Trailer: 22'8"
Overall Width w/Trailer: 8'
Boat Weight: 3,050 lbs.
Single Axle Trailer Weight: 860 lbs.
Tandem Axle Trailer Weight: 1,040 lbs.
Fuel Capacity: 29 gallons
Depth at Transom: 23 1/2"
Depth Amidship: 25 1"
Draft: 22"
Tow Bar Height to Waterline: 29"
Capacity: 12 persons or 1,720 lbs.

- a — voltmeter
- b — oil pressure gauge
- c — engine temperature gauge
- d — speedometer
- e — tachometer
- f — check engine light
- g — speedometer
- h — fuel gauge
- i — clock
- j — available slot
- k — horn
- l — accessory 1
- m — accessory 2
- n — courtesy lights switch
- o — speedo adjustment switches
- p — clock adjustment switch
- q — navigational and anchor lights switch
- r — bilge pump switch
- s — blower
- t — ignition key slot

X-STAR LAYOUT

- a — stern light receptacle
- b — blower exhaust
- c — swim platform
- d — storage under sun pad
- e — fuel tank filler
- f — engine compartment
- g — throttle/shift control
- h — instrument panel
- i — bow light
- j — glove box
- k — battery (under seat)
- l — fire extinguisher (behind seat)
- m — ski locker

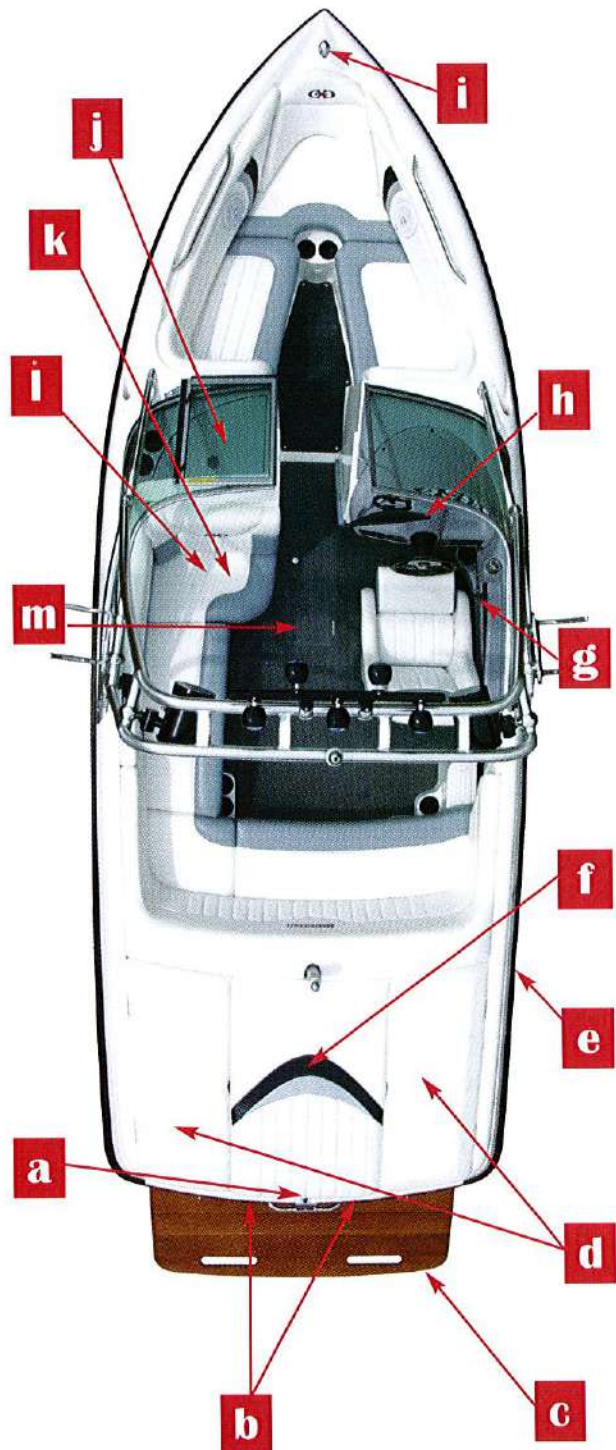

X-STAR STANDARD EQUIPMENT

X-Star Package: tower, stereo with remote, subwoofer and amp, ballast system with saddle tank ballast, transom saver, monograms, decal kit, raised platform
MasterCraft Power Vortec MX Predator
5.7L TBI EFI 350 cubic inch
GM V-8 engine—310 hp
1.5:1 gear ratio transmission
4-blade 14-inch propeller
3-year limited engine warranty
Competition throttle control
Dual exhaust system
Dual fuel filtration system
EZ Change oil kit
Fuel gauge
High-pressure in-tank fuel pump
Oil pressure gauge
SilentMaster muffler/exhaust system
Tachometer with hourmeter
Temperature gauge
Venturi air induction system
Two 12-volt DC power outlets
Chronograph clock
Companionway walk-thru wind enclosure, canvas
Custom steering wheel, ergonomically designed
Nine drink holders
Bolster driver's seat with rotocast frame, adjustable fore and aft
Lockable glove box
Observer's seat, aft-facing
Rear storage trunk under sun pad—lighted
Storage under bow seating
3-piece sun pad
Teak swim platform, removable
Tilt steering wheel
Transom drain plug
Transom handrail with integral tow loop
Water-resistant glovebox with space for stereo and integral shelf, lockable
All hand-laid fiberglass construction
All stainless steel and non-corrosive hardware
AnchorLok reinforcing plates
Bow eye
CelMaster foam seat construction
Circuit breakers
Aluminum floorboards
Cross-linked polyethylene fuel cell
Curved tempered safety glass windshield

Gel coat tolerances to +/- .005"
Heavy-duty marine carpet with 5-year limited warranty
Integrated gel coat striping
M.O.D.S.—MasterCraft Oscillation Dampening System
Magnesium bronze rudder with 1-1/8" stainless steel shaft
Magnesium bronze rudder box with o-rings and grease fittings
Magnesium bronze strut with 8-bolt mounting and dual bearings
MasterCraft electro-mechanical custom gauges
MasterCraft custom steering connection with grease fittings
Monocoque integrated stringer system
Neopyentyl glycol/isophthalic gel coat
No-spill gas fill
On-water quality assurance testing of every boat
Insulated and vented engine compartment
Precision Touch II rack and pinion system
Rigid PVC rubrail with vinyl insert
Stainless steel interior handrails
Stainless steel upholstery staples
Steel-reinforced molds
Stern eyes
Tapered prop shaft coupler with locknut
Transferable hull and structural components limited lifetime warranty
Wiring harness with color-coded and labeled wires
Automatic/manual bilge pump system
Bilge blower
Engine warning light
Fire extinguisher
Flotation meeting USCG requirements
Horn
Inland lighting
NMMA-certified for safety
Safety engine stop switch
Adjustable oversized windshield mounted convex mirror w/bracket, removable
Anodized aluminum ski pylon
Center ski storage locker
Tournament speedometers (two)
Three tracking fins
Wear-Guard ski pylon, patented

X-STAR OPTIONAL EQUIPMENT

- MasterCraft Power Vortec MX LT-R 5.7L multi-port EFI 350 cubic inch GM V-8 engine—330 hp
- Closed cooling system (not available with shower)
- European-certified package
- Bimini top (dealer installed)
- Boat cover
- Bow tonneau cover (dealer installed)
- Cockpit mooring cover (dealer installed)
- Sun top (dealer installed)
- Drop-in carpeted floor mat (dealer installed)
- Boat house cradle—galvanized
- Fiberglass swim platform—removable, ivory or white
- Raised platform
- Depth finder
- Heater
- Clarion AM/FM CD stereo system with 4 marine speakers, removable faceplate
- Clarion AM/FM CD stereo system with subwoofer and high power amp
- Clarion stereo remote control on instrument panel, included with Clarion AM/FM CD stereo option
- Wireless headphone system
- Six-disc CD changer
- Perfect Pass Pro Series
- Perfect Pass cruise control
- Perfect Pass Wakeboard
- Pressurized hot/cold shower (not available with closed cooling system)
- Extended warranty
- Tournament KPH speedometers (two—no charge option)
- Removable center seat for walk-thru
- Cockpit table
- ZeroFlex Flyer
- ZeroFlex Flyer and boat cover
- Tower lights
- Tower speakers
- Two board racks (holds four boards)
- Metal flake gel coat
- Reverse gel coat
- Rearrangement of gel coat colors
- Rearrangement of upholstery colors
- Water temperature gauge
- Walk-thru seat (ivory or white)
- Bow filler cushion
- Bow pull-up cleats
- Stern pull-up cleats
- Smart plug with alarm
- High-volume air pump
- Binding Blaster Soap Pump
- Single axle trailer with disc brakes
- Tandem axle trailer with disc brakes
- Galvanized single axle trailer with disc brakes
- Galvanized tandem axle trailer with disc brakes
- Pivot tongue on trailer, standard
- Spare trailer tire—aluminum or galvanized
- Canadian trailer specifications

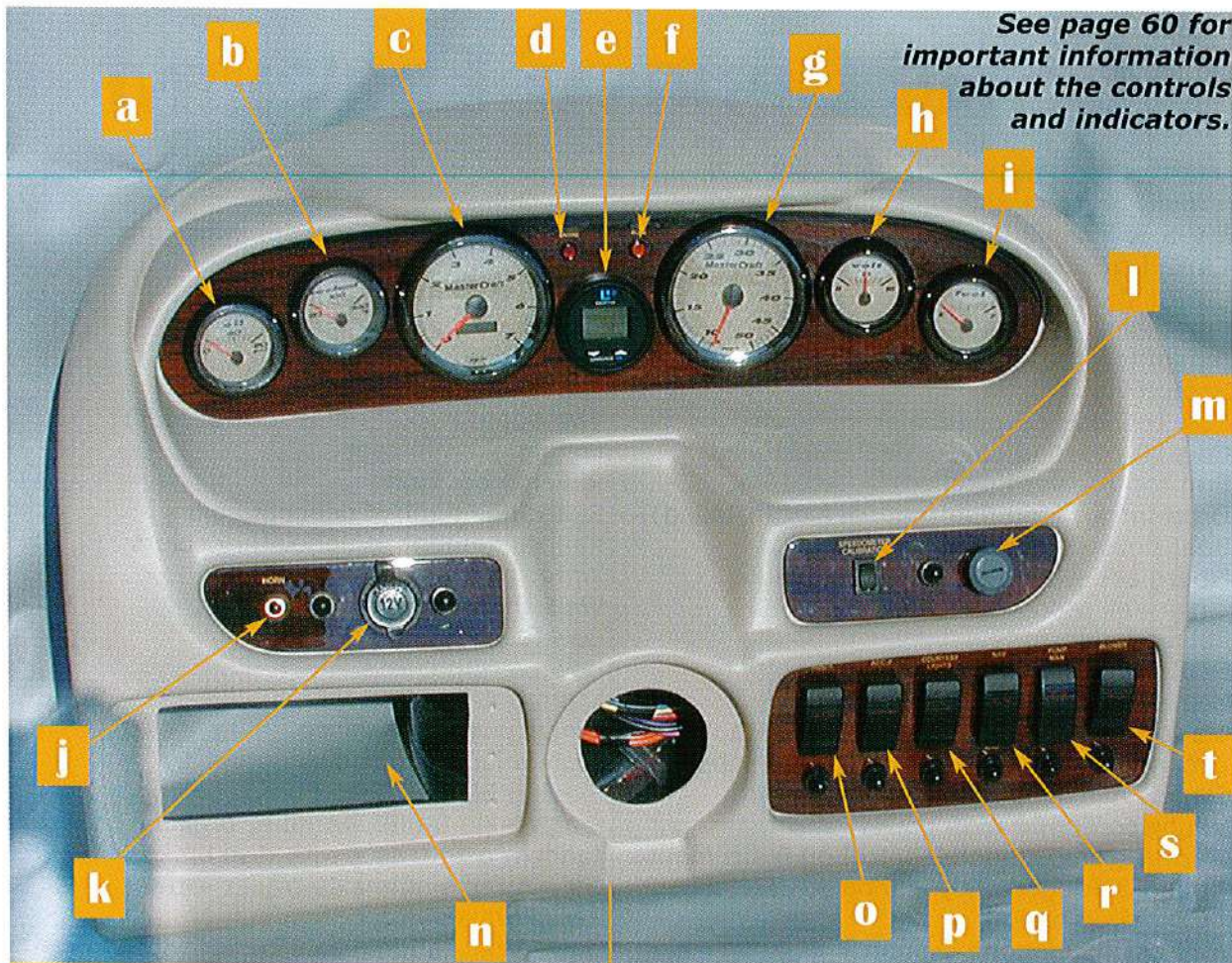

See page 60 for important information about the controls and indicators.

Length of Boat: 20'9"

Width Amidship: 95"

Overall Length w/Trailer: 22'6"

Overall Width w/Trailer: 8'2"

Boat Weight: 3,075 lbs.

Single Axle Trailer Weight: 900 lbs.

Tandem Axle Trailer Weight: 1,050 lbs.

Fuel Capacity: 45 gallons

Depth at Transom: 27 1/2"

Depth Amidship: 26 1/2"

Draft: 22 1/2"

Capacity: 11 persons or 1,620 lbs.

- a — oil pressure gauge
- b — engine temperature gauge
- c — tachometer
- d — check engine light
- e — depth finder
- f — drain plug light
- g — speedometer
- h — voltmeter
- i — fuel gauge
- j — horn
- k — 12-volt accessory
- l — speedometer calibration
- m — ignition key slot
- n — stereo insert
- o — accessory 1
- p — accessory 2
- q — courtesy lights
- r — navigational lights
- s — bilge pump switch
- t — blower

MARISTAR 210 VRS LAYOUT

- a — stern light receptacle
- b — blower exhaust
- c — storage under sun pad
- d — fuel tank filler
- e — engine compartment
- f — battery (under seat)
- g — throttle/shift control
- h — instrument panel
- i — bow light
- j — glove box
- k — fire extinguisher (behind seat)
- l — ski locker

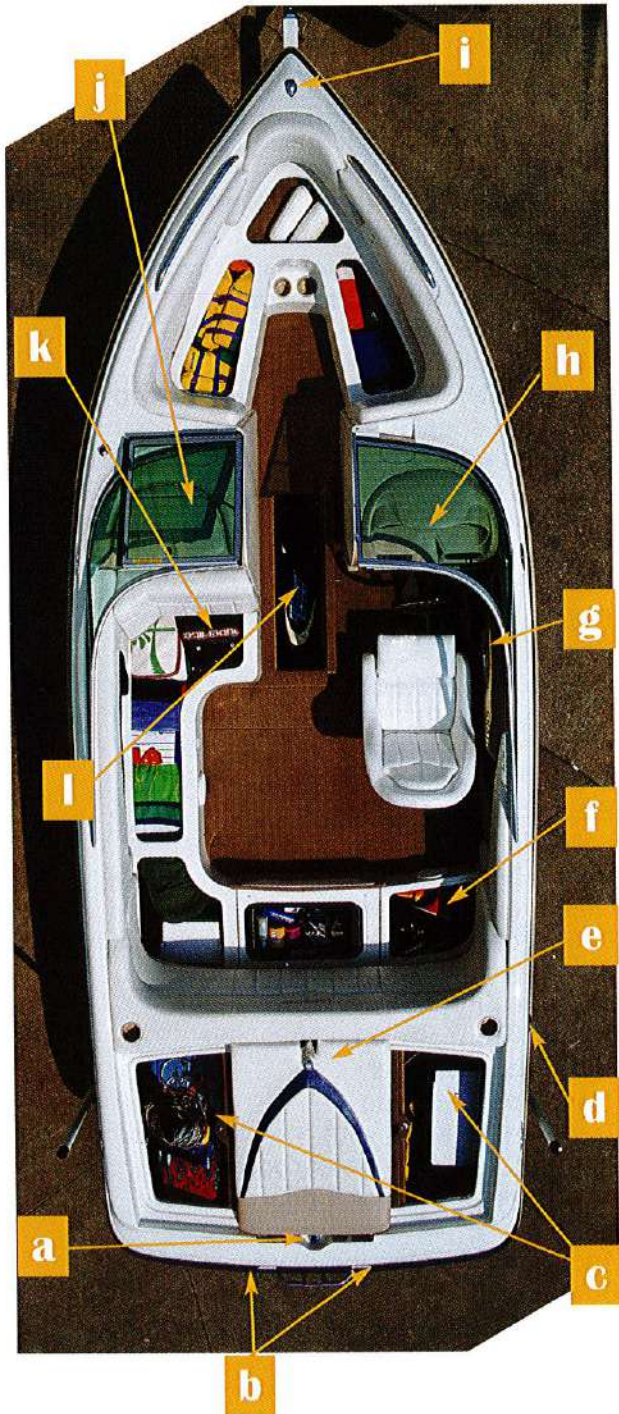

MARISTAR 210 STANDARD EQUIPMENT

MasterCraft Power Vortec MX Predator
5.7L TBI EFI 350 cubic inch
GM V-8 engine—310 hp
1.5:1 gear ratio transmission
4-blade 14-inch propeller
3-year limited engine warranty
Competition throttle control
Dual exhaust system
Fuel filtration system
EZ Change oil kit
Fuel gauge
High-pressure in-tank fuel pump
Oil pressure gauge
SilentMaster muffler/exhaust system
Tachometer with hourmeter
Temperature gauge
Two 12-volt DC power outlets
Clarion AM/FM CD stereo system with 4
marine speakers
Companionway walk-thru wind enclosure,
canvas
Custom steering wheel,
ergonomically designed
Custom wood grain dash
Depth finder
Drink holders
Bolster driver's seat with rotocast frame,
adjustable fore and aft
Driver's side armrest
Driver's side storage tray
Electrically controlled engine
hatch lifts
Lockable glove box
Observer's seat, aft-facing
Rear storage trunk under sun pad—lighted
Storage under bow seating
3-piece sun pad
Teak swim platform, removable
Tilt steering wheel
Transom drain plug
Transom handrail with integral tow loop
All hand-laid fiberglass construction
All stainless steel and non-corrosive
hardware
AnchorLok reinforcing plates
Bow eye
CelMaster foam seat construction
Circuit breakers
Aluminum floorboards
Cross-linked polyethylene fuel cell

Curved tempered safety glass windshield
Gel coat tolerances to +/- .005"
Heavy-duty 40 oz. marine carpet
with 5-year limited warranty
Integrated gel coat striping
M.O.D.S.—MasterCraft Oscillation
Dampening System
Magnesium bronze rudder
with 1-1/8" stainless steel shaft
Magnesium bronze rudder box with o-rings
and grease fittings
Magnesium bronze strut with 8-bolt
mounting and dual bearings
MasterCraft electro-mechanical
custom gauges
MasterCraft custom steering connection
with grease fittings
Monocoque integrated stringer system
Neopyentyl glycol/isophthalic gel coat
No-spill gas fill
On-water quality assurance testing
of every boat
Insulated and vented engine
compartment
Precision Touch II rack and pinion system
Pull up cleats
Rigid PVC rubrail with vinyl insert
Stainless steel upholstery staples
Steel-reinforced molds
Stern eyes
Tapered prop shaft coupler with locknut
Transferable hull and structural
components limited lifetime warranty
Wiring harness with color-coded and
labeled wires
Automatic/manual bilge pump system
Bilge blower
Engine warning light
Fire extinguisher
Flotation meeting USCG requirements
Horn
Inland lighting
NMMA-certified for safety
Safety engine stop switch
AWSA Endorsed
Adjustable oversized windshield mounted
convex mirror w/bracket, removable
Anodized aluminum ski pylon
Speedometer
Wear-Guard ski pylon, patented

MARISTAR 210 OPTIONAL EQUIPMENT

MasterCraft Power Cadillac Northstar phased port EFI, 32-valve, 4.6 liter V-8 engine—320 hp, includes closed cooling system) *Limited Availability*
MasterCraft Power Vortec MX LT-R 5.7L multi-port EFI 350 cubic inch GM V-8 engine—330 hp
Closed cooling system (not available with shower. Standard on Cadillac Northstar engine)
European-certified package
Bimini top (dealer installed)
Boat cover
Bow tonneau cover (dealer installed)
Cockpit mooring cover (dealer installed)
Sun top (dealer installed)
Boat house cradle—galvanized
Fiberglass swim platform—removable, ivory
Heater
Six-disc CD changer
Perfect Pass cruise control
Perfect Pass Wakeboard
Pressurized hot/cold shower (not available with closed cooling system or Northstar engine)
Extended warranty

Cockpit table, stowable with drink holders
ZeroFlex Flyer
ZeroFlex Flyer boat cover
Tower lights
Tower speakers
Two board racks (holds four boards)
Transom saver
Metal flake gel coat
Rearrangement of upholstery colors
Wireless headphone system
Raised platform
Bow filler cushion
Message center
KGB Ballast system
Double ballast system
High-volume air pump
Binding Blaster Soap Pump
Single axle trailer with disc brakes
Tandem axle trailer with disc brakes
Galvanized single axle trailer with disc brakes
Galvanized tandem axle trailer with disc brakes
Pivot tongue on trailer, standard
Spare trailer tire—aluminum or galvanized
Canadian trailer specifications

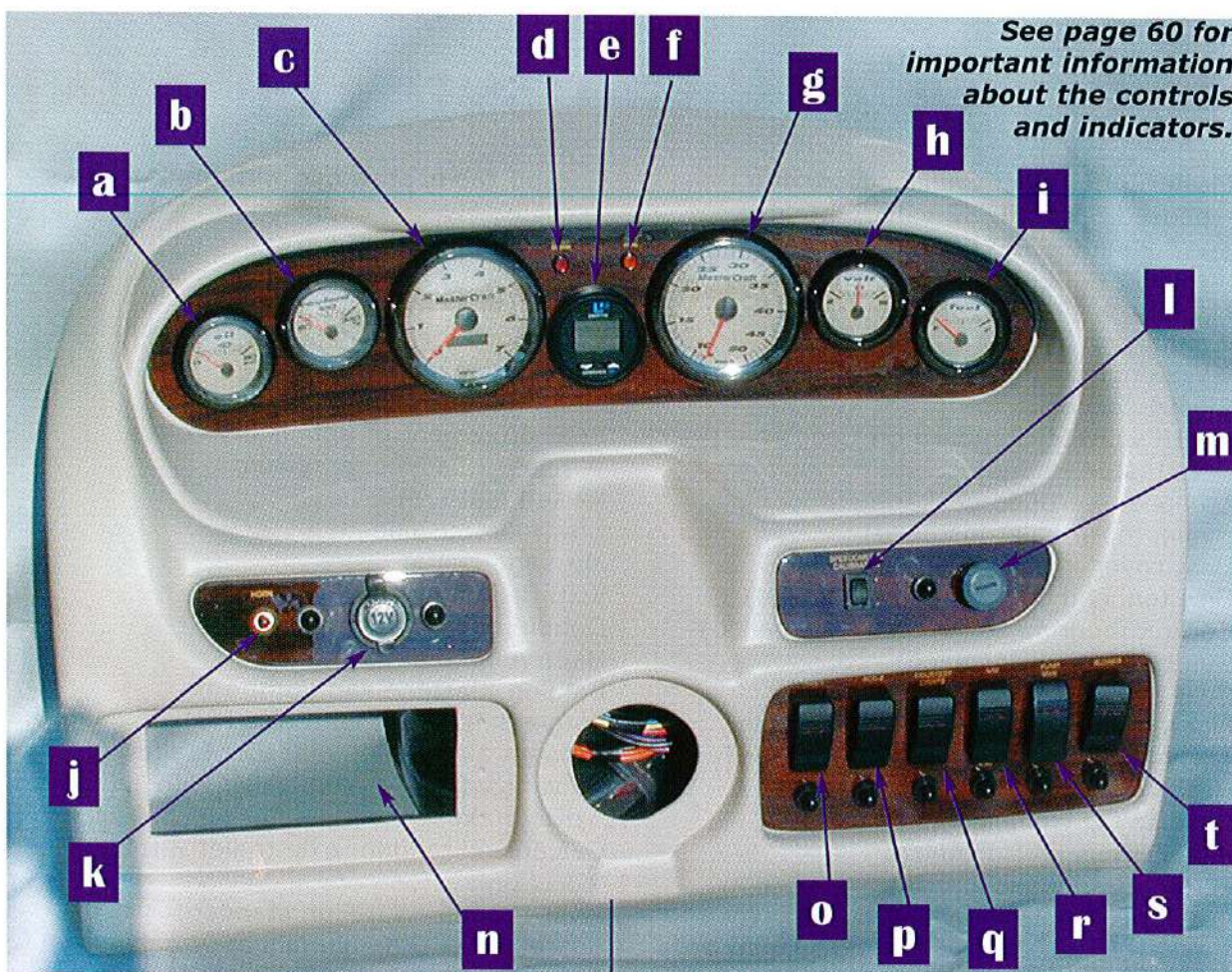

See page 60 for important information about the controls and indicators.

Length of Boat: 22'8"

Width Amidship: 98"

Overall Length w/Trailer: 24'1"

Overall Width w/Trailer: 8'3"

Boat Weight: 3,300 lbs.

Tandem Axle Trailer Weight: 1,180 lbs.

Fuel Capacity: 61 gallons

Depth at Transom: 27 1/2"

Depth Amidship: 26 1/2"

Draft: 22 1/2"

Capacity: 12 persons or 1,660 lbs.

- a — oil pressure gauge
- b — engine temperature gauge
- c — tachometer
- d — check engine light
- e — depth finder
- f — drain plug light
- g — speedometer
- h — voltmeter
- i — fuel gauge
- j — horn
- k — 12-volt accessory
- l — speedometer calibration
- m — ignition key slot
- n — stereo insert
- o — accessory 1
- p — accessory 2
- q — courtesy lights
- r — navigational lights
- s — bilge pump switch
- t — blower

MARISTAR 230 VRS LAYOUT

- a — stern light receptacle
- b — blower exhaust
- c — storage under sun pad
- d — fuel tank filler
- e — engine compartment
- f — battery (under seat)
- g — throttle/shift control
- h — instrument panel
- i — bow light
- j — glove box
- k — fire extinguisher (behind seat)
- l — ski locker

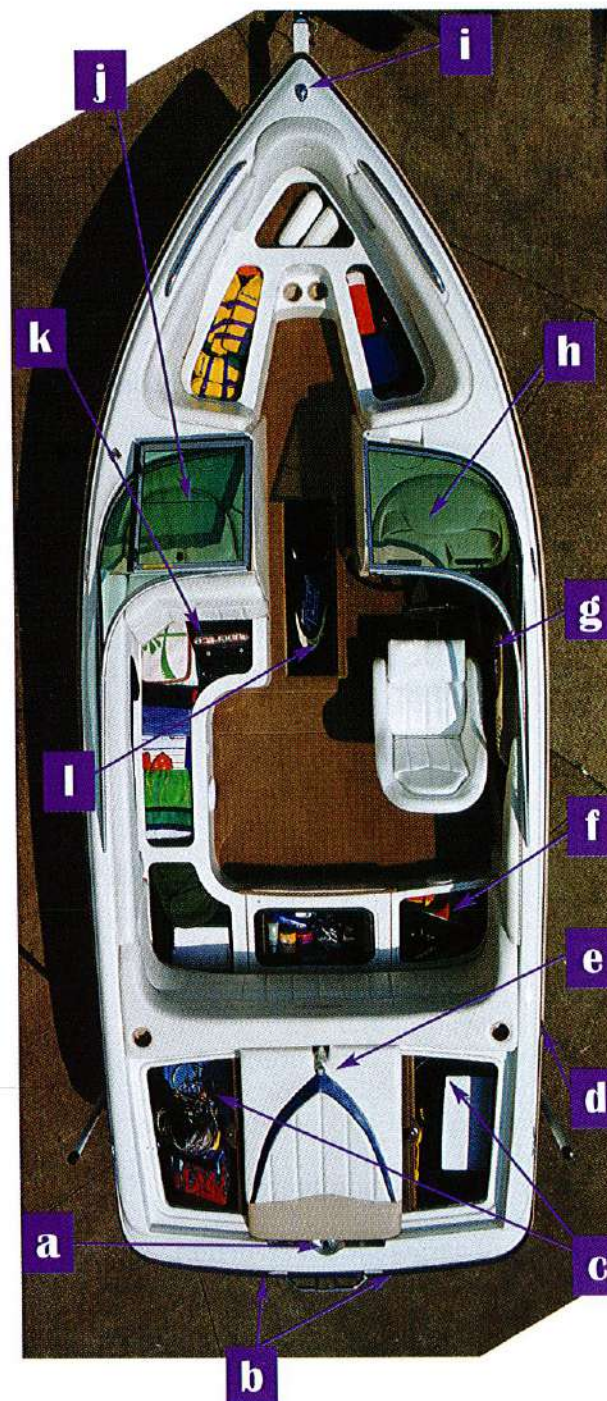

Due to the unavailability of an overhead picture of the 230 at press time, a MariStar 210 was used due to the similarity in placement of components.

MARISTAR 230 STANDARD EQUIPMENT

MasterCraft Power Vortec MX Predator
5.7L TBI EFI 350 cubic inch
GM V-8 engine—310 hp
1.5:1 gear ratio transmission
4-blade 14-inch propeller
3-year limited engine warranty
Competition throttle control
Dual exhaust system
Fuel filtration system
EZ Change oil kit
Fuel gauge
High-pressure in-tank fuel pump
Oil pressure gauge
SilentMaster muffler/exhaust system
Tachometer with hourmeter
Temperature gauge
Two 12-volt DC power outlets
Clarion AM/FM CD stereo system with 4 marine speakers
Companionway walk-thru wind enclosure, canvas
Custom steering wheel, ergonomically designed
Custom wood grain dash
Depth finder
Drink holders
Bolster driver's seat with rotocast frame, adjustable fore and aft
Driver's side armrest
Driver's side storage tray
Lockable glove box
Observer's seat, aft-facing
Rear storage trunk under sun pad—lighted
Storage under bow seating
3-piece sun pad
Teak swim platform, removable
Tilt steering wheel
Transom drain plug
Transom handrail with integral tow loop
All hand-laid fiberglass construction
All stainless steel and non-corrosive hardware
AnchorLok reinforcing plates
Bow eye
CelMaster foam seat construction
Circuit breakers
Aluminum floorboards
Cross-linked polyethylene fuel cell
Curved tempered safety glass windshield
Gel coat tolerances to +/- .005"

Heavy-duty 40 oz. marine carpet with 5-year limited warranty
Integrated gel coat striping
M.O.D.S.—MasterCraft Oscillation Dampening System
Magnesium bronze rudder with 1-1/8" stainless steel shaft
Magnesium bronze rudder box with o-rings and grease fittings
Magnesium bronze strut with 8-bolt mounting and dual bearings
MasterCraft electro-mechanical custom gauges
MasterCraft custom steering connection with grease fittings
Monocoque integrated stringer system
Neopyentyl glycol/isophthalic gel coat
No-spill gas fill
On-water quality assurance testing of every boat
Insulated and vented engine compartment
Precision Touch II rack and pinion system
Rigid PVC rubrail with vinyl insert
Stainless steel upholstery staples
Steel-reinforced molds
Stern eyes
Tapered prop shaft coupler with locknut
Transferable hull and structural components limited lifetime warranty
Wiring harness with color-coded and labeled wires
Automatic/manual bilge pump system
Bilge blower
Engine warning light
Fire extinguisher
Flotation meeting USCG requirements
Horn
Inland lighting
NMMA-certified for safety
Safety engine stop switch
AWSA Endorsed
Adjustable oversized windshield mounted convex mirror w/bracket, removable
Anodized aluminum ski pylon
Stainless steel pop-up and pull-up cleats
Speedometer
Wear-Guard ski pylon, patented

MARISTAR 230 OPTIONAL EQUIPMENT

MasterCraft Power Cadillac Northstar phased port EFI, 32-valve, 4.6 liter V-8 engine—320 hp, includes closed cooling system) *Limited Availability*
MasterCraft Power Vortec MX LT-R 5.7L multi-port EFI 350 cubic inch GM V-8 engine—330 hp
Closed cooling system (not available with shower. Standard on Cadillac Northstar engine)
European-certified package
Bimini top (dealer installed)
Boat cover
Bow tonneau cover (dealer installed)
Cockpit mooring cover (dealer installed)
Sun top (dealer installed)
Boat house cradle—galvanized
Fiberglass swim platform—removable, ivory
Heater
Six-disc CD changer
Perfect Pass cruise control
Perfect Pass Wakeboard
Pressurized hot/cold shower (not available with closed cooling system or Northstar engine)
Extended warranty

Cockpit table, stowable with drink holders
ZeroFlex Flyer
ZeroFlex Flyer boat cover
Tower lights
Tower speakers
Two board racks (holds four boards)
Transom saver
Metal flake gel coat
Rearrangement of upholstery colors
Wireless headphone system
Raised platform
Bow filler cushion
Message center
High-volume air pump
Binding Blaster Soap Pump
KGB Ballast System
Double ballast system
Tandem axle trailer with disc brakes
Galvanized tandem axle trailer with disc brakes
Pivot tongue on trailer, standard
Spare trailer tire—aluminum or galvanized
Canadian trailer specifications

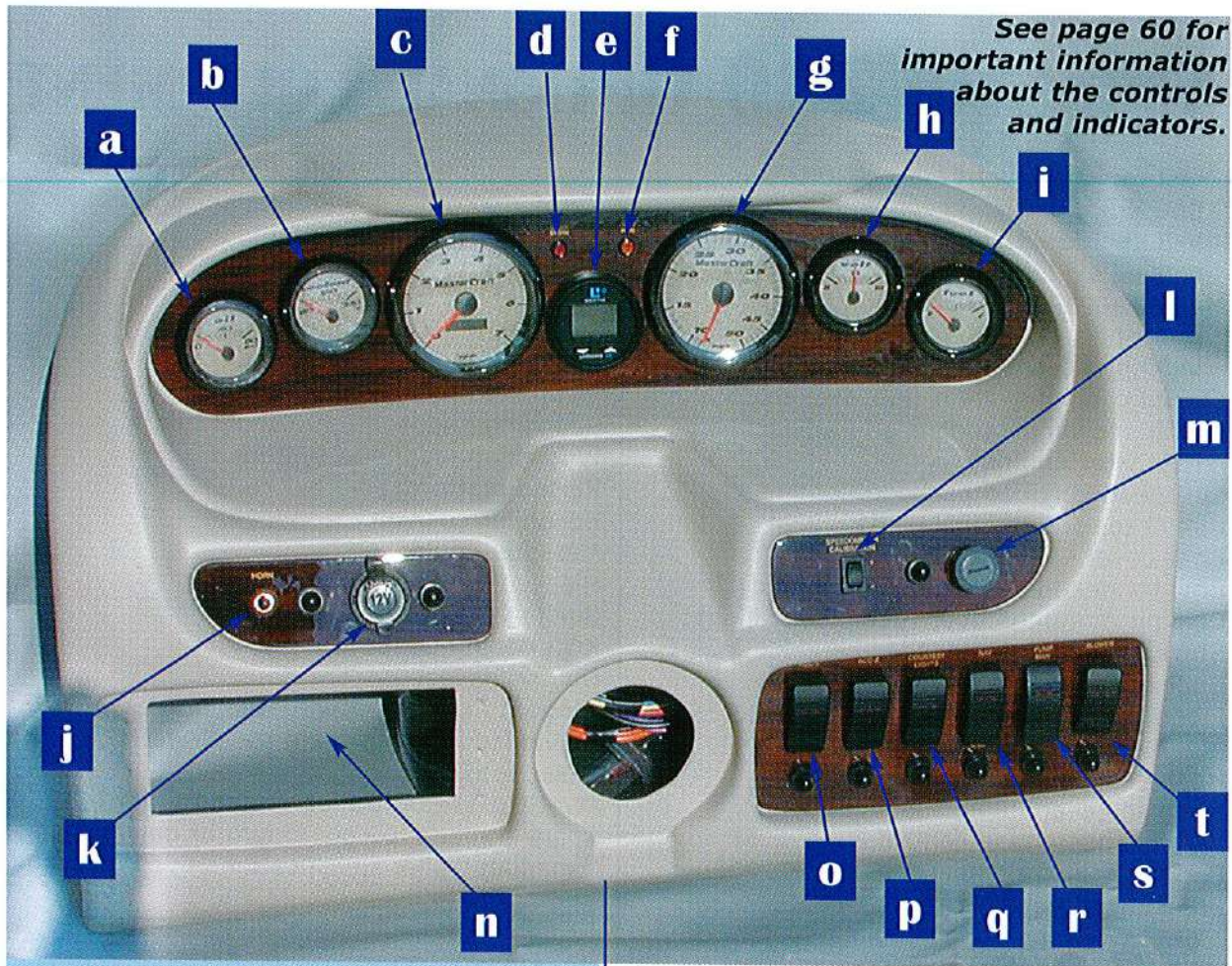

See page 60 for important information about the controls and indicators.

Length of Boat: 22'8"
Width Amidship: 98"
Overall Length w/Trailer: 24'1"
Overall Width w/Trailer: 8'3"
Boat Weight: 3,300 lbs.
Tandem Axle Trailer Weight: 1,180 lbs.
Fuel Capacity: 61 gallons
Depth at Transom: 27 1/2"
Depth Amidship: 26 1/2"
Draft: 22 1/2"
Capacity: 12 persons or 1,660 lbs.

- a — oil pressure gauge
- b — engine temperature gauge
- c — tachometer
- d — check engine light
- e — depth finder
- f — drain plug light
- g — speedometer
- h — voltmeter
- i — fuel gauge
- j — horn
- k — 12-volt accessory
- l — speedometer calibration
- m — ignition key slot
- n — stereo insert
- o — accessory 1
- p — accessory 2
- q — courtesy lights
- r — navigational lights
- s — bilge pump switch
- t — blower

MARISTAR 230 SV LAYOUT

- a — stern light receptacle
- b — blower exhaust
- c — storage under sun pad
- d — fuel tank filler
- e — engine compartment
- f — battery (under seat)
- g — throttle/shift control
- h — instrument panel
- i — bow light
- j — glove box
- k — fire extinguisher (behind seat)
- l — ski locker

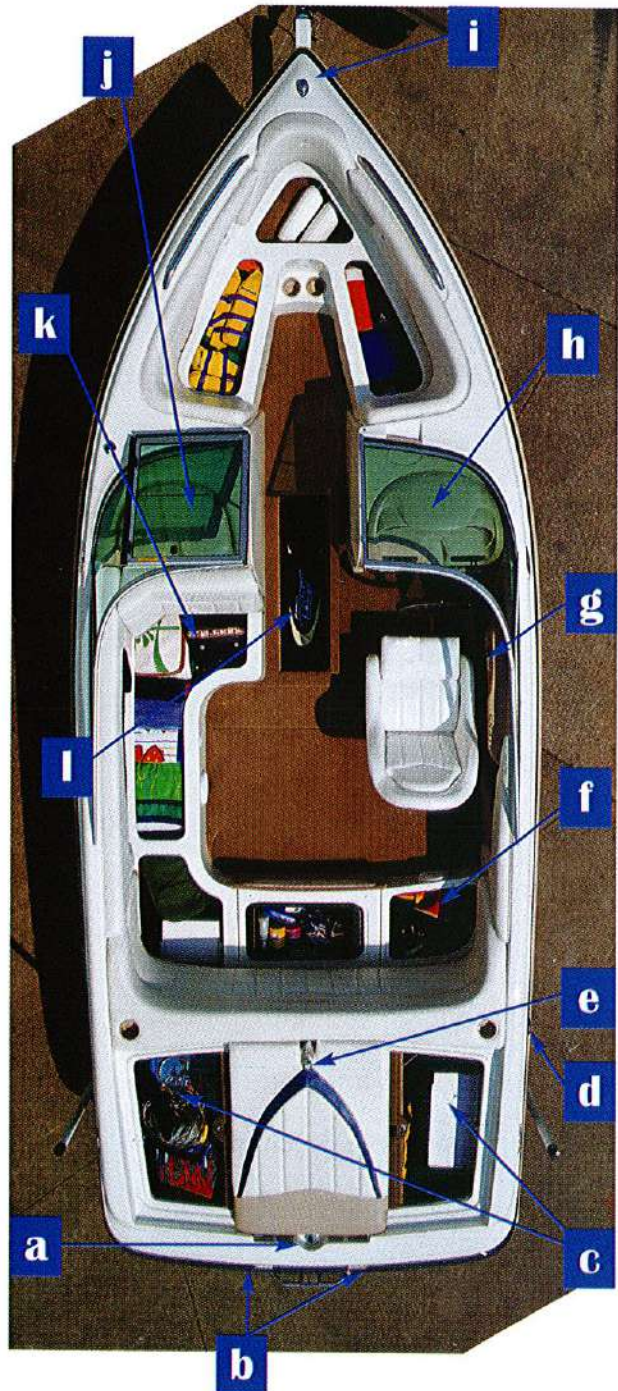

Due to the unavailability of an overhead picture of the 230SV at press time, a MariStar 210 was used due to the similarity in placement of components.

MARISTAR 230 SV STANDARD EQUIPMENT

MasterCraft Power Vortec MX Predator
5.7L TBI EFI 350 cubic inch
GM V-8 engine—310 hp
1.5:1 gear ratio transmission
4-blade 14-inch propeller
3-year limited engine warranty
Competition throttle control
Dual exhaust system
Fuel filtration system
EZ Change oil kit
Fuel gauge
High-pressure in-tank fuel pump
Oil pressure gauge
SilentMaster muffler/exhaust system
Tachometer with hourmeter
Temperature gauge
Two 12-volt DC power outlets
Clarion AM/FM CD stereo system with 4
marine speakers
Companionway walk-thru wind enclosure,
canvas
Custom steering wheel,
ergonomically designed
Depth finder
Drink holders
Bolster driver's seat with rotocast frame,
adjustable fore and aft
Driver's side armrest
Driver's side storage tray
Lockable glove box
Observer's seat, swivel
Rear storage trunk under sun pad—lighted
Storage under bow seating
3-piece sun pad
Teak swim platform, removable
Tilt steering wheel
Transom drain plug
Transom handrail with integral tow loop
All hand-laid fiberglass construction
All stainless steel and non-corrosive
hardware
AnchorLok reinforcing plates
Bow eye
CelMaster foam seat construction
Circuit breakers
Aluminum floorboards
Cross-linked polyethylene fuel cell
Curved tempered safety glass windshield
Gel coat tolerances to +/- .005"
Heavy-duty 40 oz. marine carpet

with 5-year limited warranty
Integrated gel coat striping
Low-profile polyester resin
M.O.D.S.—MasterCraft Oscillation
Dampening System
Magnesium bronze rudder
with 1-1/8" stainless steel shaft
Magnesium bronze rudder box with o-rings
and grease fittings
Magnesium bronze strut with 8-bolt
mounting and dual bearings
MasterCraft electro-mechanical
custom gauges
MasterCraft custom steering connection
with grease fittings
Monocoque integrated stringer system
Neopyentyl glycol/isophthalic gel coat
No-spill gas fill
On-water quality assurance testing
of every boat
Insulated and vented engine
compartment
Precision Touch II rack and pinion system
Rigid PVC rubrail with vinyl insert
Stainless steel upholstery staples
Steel-reinforced molds
Stern eyes
Tapered prop shaft coupler with locknut
Transferable hull and structural
components limited lifetime warranty
Wiring harness with color-coded and
labeled wires
Automatic/manual bilge pump system
Bilge blower
Engine warning light
Fire extinguisher
Flotation meeting USCG requirements
Horn
Inland lighting
NMMA-certified for safety
Safety engine stop switch
AWSA Endorsed
Adjustable oversized windshield mounted
convex mirror w/bracket, removable
Anodized aluminum ski pylon
Stainless steel pop-up and pull-up cleats
Speedometer
Wear-Guard ski pylon, patented

MARISTAR 230 SV OPTIONAL EQUIPMENT

MasterCraft Power Cadillac Northstar phased port EFI, 32-valve, 4.6 liter V-8 engine—320 hp, includes closed cooling system) *Limited Availability*
MasterCraft Power Vortec MX LT-R 5.7L multi-port EFI 350 cubic inch GM V-8 engine—330 hp
Closed cooling system (not available with shower. Standard on Cadillac Northstar engine)
European-certified package
Bimini top (dealer installed)
Boat cover
Bow tonneau cover (dealer installed)
Cockpit mooring cover (dealer installed)
Sun top (dealer installed)
Boat house cradle—galvanized
Fiberglass swim platform—removable, ivory
Heater
Six-disc CD changer
Perfect Pass cruise control
Perfect Pass Wakeboard
Pressurized hot/cold shower (not available with closed cooling system or Northstar engine)
Extended warranty

Cockpit table, stowable with drink holders
ZeroFlex Flyer
ZeroFlex Flyer boat cover
Tower lights
Tower speakers
Two board racks (holds four boards)
Transom saver
Metal flake gel coat
Rearrangement of upholstery colors
Wireless headphone system
Raised platform
Bow filler cushion
Message center
KGB Ballast System
Double ballast system
High-volume air pump
Binding Blaster Soap Pump
Tandem axle trailer with disc brakes
Galvanized tandem axle trailer with disc brakes
Pivot tongue on trailer, standard
Spare trailer tire—aluminum or galvanized
Canadian trailer specifications

See page 60 for important information about the controls and indicators.

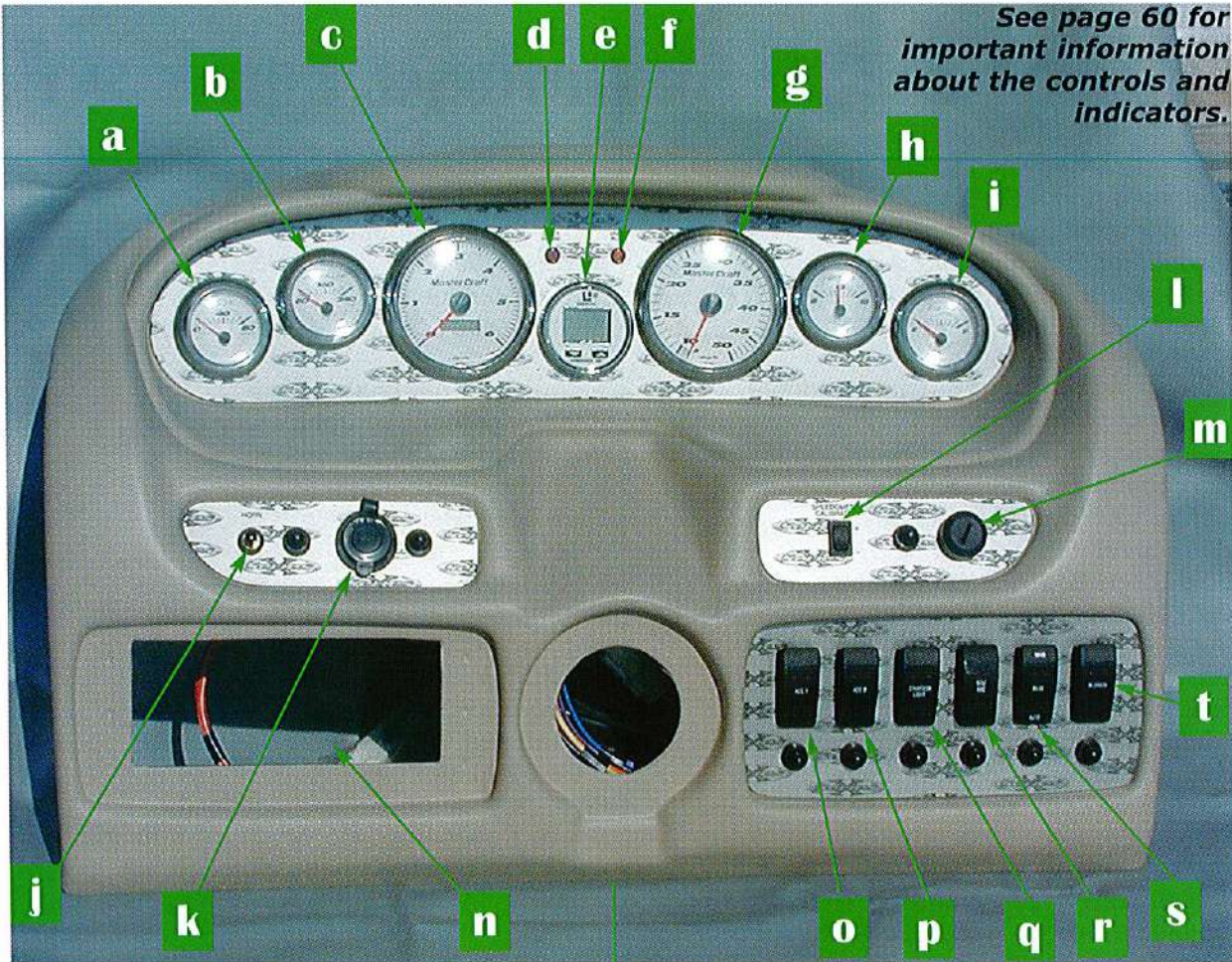

Length of Boat: 20'9"
Width Amidship: 95"
Overall Length w/Trailer: 22'6"
Overall Width w/Trailer: 8'2"
Boat Weight: 3,075 lbs.
Single Axle Trailer Weight: 900 lbs.
Tandem Axle Trailer Weight: 1,050 lbs.
Fuel Capacity: 45 gallons
Depth at Transom: 27 1/2"
Depth Amidship: 26 1/2"
Draft: 22 1/2"
Capacity: 11 persons or 1,620 lbs.

- a — oil pressure gauge
- b — engine temperature gauge
- c — tachometer
- d — check engine light
- e — depth finder
- f — drain plug light
- g — speedometer
- h — voltmeter
- i — fuel gauge
- j — horn
- k — 12-volt accessory
- l — speedometer calibration
- m — ignition key slot
- n — stereo insert
- o — accessory 1
- p — accessory 2
- q — courtesy lights
- r — navigational lights
- s — bilge pump switch
- t — blower

X-10 LAYOUT

- a — stern light receptacle
- b — blower exhaust
- c — storage under sun pad
- d — fuel tank filler
- e — engine compartment
- f — battery (under seat)
- g — throttle/shift control
- h — instrument panel
- i — bow light
- j — glove box
- k — fire extinguisher (behind seat)
- l — ski locker

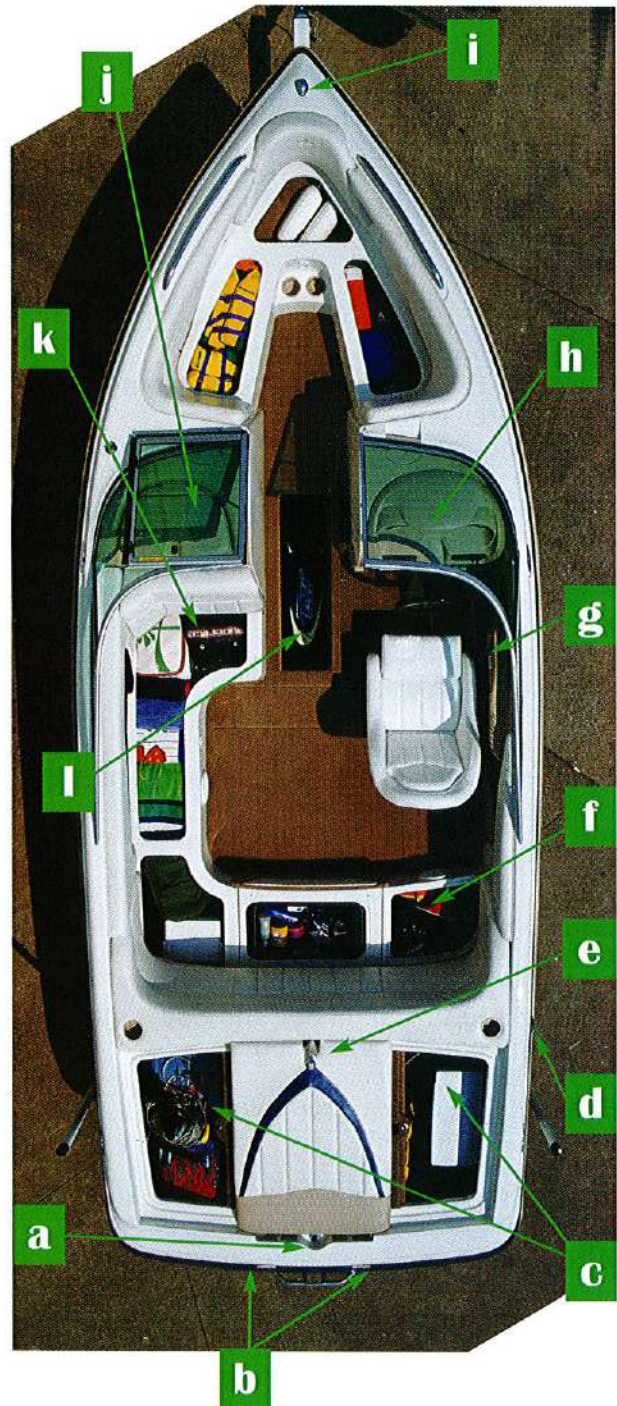

Due to the unavailability of an overhead picture of the X-10 at press time, a MariStar 210 was used due to the similarity in placement of components.

X-10 STANDARD EQUIPMENT

Stereo amp/subwoofer, tower, monograms, instrumentation and applique (color of dash panel), graphics, KGB ballast system with saddle tanks, black gunnel trim, transom saver

MasterCraft Power Vortec MX Predator

5.7L TBI EFI 350 cubic inch

GM V-8 engine—310 hp

1.5:1 gear ratio transmission

4-blade 14-inch propeller

3-year limited engine warranty

Competition throttle control

Dual exhaust system

Fuel filtration system

EZ Change oil kit

Fuel gauge

High-pressure in-tank fuel pump

Oil pressure gauge

SilentMaster muffler/exhaust system

Tachometer with hourmeter

Temperature gauge

Two 12-volt DC power outlets

Clarion AM/FM CD stereo system with 4 marine speakers

Companionway walk-thru wind enclosure, canvas

Custom steering wheel, ergonomically designed

Custom wood grain dash

Depth finder

Drink holders

Bolster driver's seat with rotocast frame, adjustable fore and aft

Driver's side armrest

Driver's side storage tray

Electrically controlled engine hatch lifts

Lockable glove box

Observer's seat, aft-facing

Rear storage trunk under sun pad—lighted

Storage under bow seating

3-piece sun pad

Teak swim platform, removable

Tilt steering wheel

Transom drain plug

Transom handrail with integral tow loop

All hand-laid fiberglass construction

All stainless steel and non-corrosive hardware

AnchorLok reinforcing plates

Bow eye

CelMaster foam seat construction

Circuit breakers

Aluminum floorboards

Cross-linked polyethylene fuel cell

Curved tempered safety glass windshield

Gel coat tolerances to +/- .005"

Heavy-duty 40 oz. marine carpet with 5-year limited warranty

Integrated gel coat striping

M.O.D.S.—MasterCraft Oscillation Dampening System

Magnesium bronze rudder

with 1-1/8" stainless steel shaft

Magnesium bronze rudder box with o-rings and grease fittings

Magnesium bronze strut with 8-bolt mounting and dual bearings

MasterCraft electro-mechanical custom gauges

MasterCraft custom steering connection with grease fittings

Monocoque integrated stringer system

Neopyentyl glycol/isophthalic gel coat

No-spill gas fill

On-water quality assurance testing of every boat

Insulated and vented engine compartment

Precision Touch II rack and pinion system

Pull up cleats

Rigid PVC rubrail with vinyl insert

Stainless steel upholstery staples

Steel-reinforced molds

Stern eyes

Tapered prop shaft coupler with locknut

Transferable hull and structural components limited lifetime warranty

Wiring harness with color-coded and labeled wires

Automatic/manual bilge pump system

Bilge blower

Engine warning light

Fire extinguisher

Flotation meeting USCG requirements

Horn

Inland lighting

NMMA-certified for safety

Safety engine stop switch

AWSA Endorsed

Adjustable oversized windshield mounted convex mirror w/bracket, removable

Anodized aluminum ski pylon

Speedometer

Wear-Guard ski pylon, patented

X-10 OPTIONAL EQUIPMENT

MasterCraft Power Cadillac Northstar phased port EFI, 32-valve, 4.6 liter V-8 engine—320 hp, includes closed cooling system) *Limited Availability*
MasterCraft Power Vortec MX LT-R 5.7L multi-port EFI 350 cubic inch GM V-8 engine—330 hp
Closed cooling system (not available with shower. Standard on Cadillac Northstar engine)
European-certified package
Bimini top (dealer installed)
Boat cover
Bow tonneau cover (dealer installed)
Cockpit mooring cover (dealer installed)
Sun top (dealer installed)
Boat house cradle—galvanized
Fiberglass swim platform—removable, ivory
Heater
Six-disc CD changer
Perfect Pass cruise control
Perfect Pass Wakeboard
Pressurized hot/cold shower (not available with closed cooling system or Northstar engine)
Extended warranty
Cockpit table, stowable with drink holders
ZeroFlex Flyer

ZeroFlex Flyer boat cover
Tower lights
Tower speakers
Two board racks (holds four boards)
Metal flake gel coat
Rearrangement of upholstery colors
Wireless headphone system
Raised platform
Bow filler cushion
Message center
High-volume air pump
Binding Blaster Soap Pump
Single axle trailer with disc brakes
Tandem axle trailer with disc brakes
Galvanized single axle trailer with disc brakes
Galvanized tandem axle trailer with disc brakes
Pivot tongue on trailer, standard
Spare trailer tire—aluminum or galvanized
Canadian trailer specifications

See page 60 for important information about the controls and indicators.

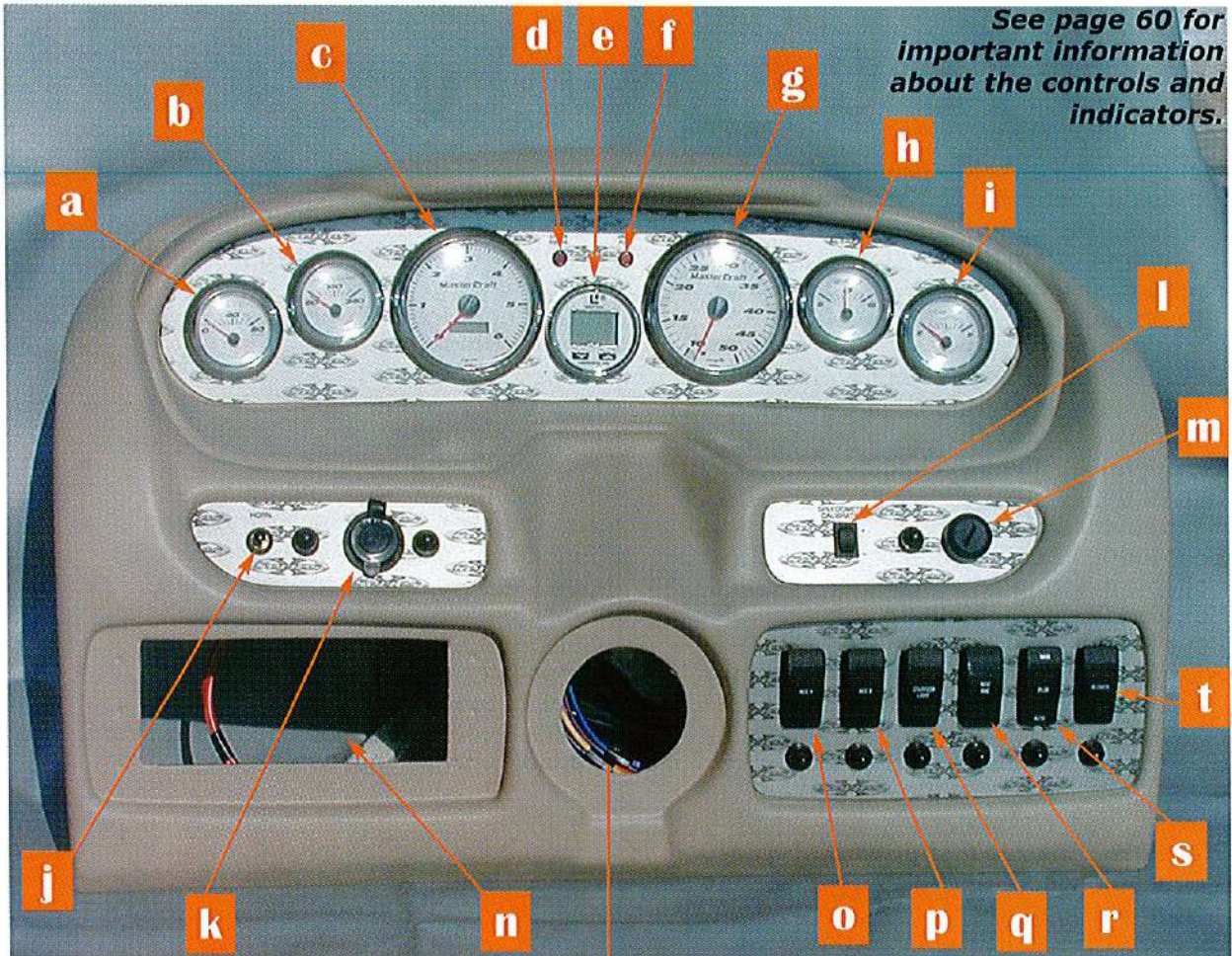

Length of Boat: 22'8"
Width Amidship: 98"
Overall Length w/Trailer: 24'1"
Overall Width w/Trailer: 8'3"
Boat Weight: 3,300 lbs.
Tandem Axle Trailer Weight: 1,180 lbs.
Fuel Capacity: 61 gallons
Depth at Transom: 27 1/2"
Depth Amidship: 26 1/2"
Draft: 22 1/2"
Capacity: 12 persons or 1,660 lbs.

- a — oil pressure gauge
- b — engine temperature gauge
- c — tachometer
- d — check engine light
- e — depth finder
- f — drain plug light
- g — speedometer
- h — voltmeter
- i — fuel gauge
- j — horn
- k — 12-volt accessory
- l — speedometer calibration
- m — ignition key slot
- n — stereo insert
- o — accessory 1
- p — accessory 2
- q — courtesy lights
- r — navigational lights
- s — bilge pump switch
- t — blower

X-30 LAYOUT

- a — stern light receptacle
- b — blower exhaust
- c — storage under sun pad
- d — fuel tank filler
- e — engine compartment
- f — battery (under seat)
- g — throttle/shift control
- h — instrument panel
- i — bow light
- j — glove box
- k — fire extinguisher (behind seat)
- l — ski locker

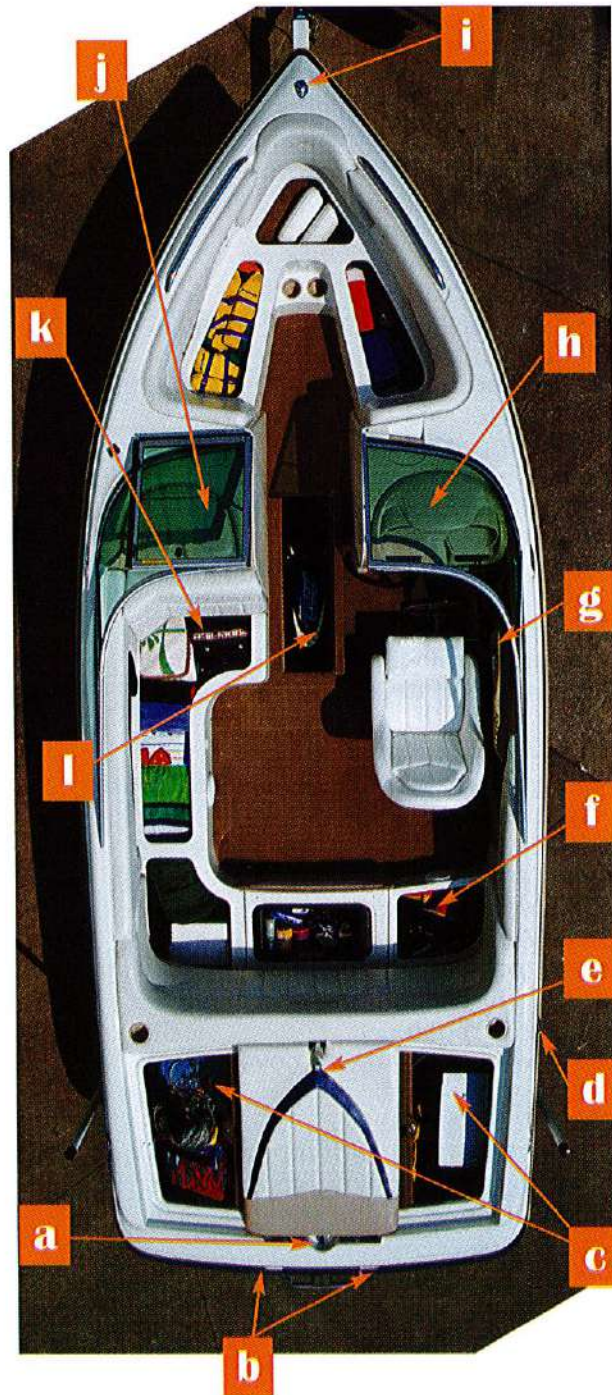

Due to the unavailability of an overhead picture of the X-30 at press time, a MariStar 210 was used due to the similarity in placement of components.

X-30 STANDARD EQUIPMENT

Stereo amp/subwoofer, tower, monograms, instrumentation and applique (color of dash panel), graphics, KGB ballast system with saddle tanks, black gunnel trim, transom saver

MasterCraft Power Vortec MX Predator

5.7L TBI EFI 350 cubic inch

GM V-8 engine—310 hp

1.5:1 gear ratio transmission

4-blade 14-inch propeller

3-year limited engine warranty

Competition throttle control

Dual exhaust system

Fuel filtration system

EZ Change oil kit

Fuel gauge

High-pressure in-tank fuel pump

Oil pressure gauge

SilentMaster muffler/exhaust system

Tachometer with hourmeter

Temperature gauge

Two 12-volt DC power outlets

Clarion AM/FM CD stereo system with 4 marine speakers

Companionway walk-thru wind enclosure, canvas

Custom steering wheel, ergonomically designed

Custom wood grain dash

Depth finder

Drink holders

Bolster driver's seat with rotocast frame, adjustable fore and aft

Driver's side armrest

Driver's side storage tray

Lockable glove box

Observer's seat, aft-facing

Rear storage trunk under sun pad—lighted

Storage under bow seating

3-piece sun pad

Teak swim platform, removable

Tilt steering wheel

Transom drain plug

Transom handrail with integral tow loop

All hand-laid fiberglass construction

All stainless steel and non-corrosive hardware

AnchorLok reinforcing plates

Bow eye

CelMaster foam seat construction

Circuit breakers

Aluminum floorboards

Cross-linked polyethylene fuel cell

Curved tempered safety glass windshield

Gel coat tolerances to +/- .005"

Heavy-duty 40 oz. marine carpet with 5-year limited warranty

Integrated gel coat striping

M.O.D.S.—MasterCraft Oscillation Dampening System

Magnesium bronze rudder

with 1-1/8" stainless steel shaft

Magnesium bronze rudder box with o-rings and grease fittings

Magnesium bronze strut with 8-bolt mounting and dual bearings

MasterCraft electro-mechanical custom gauges

MasterCraft custom steering connection with grease fittings

Monocoque integrated stringer system

Neopyentyl glycol/isophthalic gel coat

No-spill gas fill

On-water quality assurance testing of every boat

Insulated and vented engine compartment

Precision Touch II rack and pinion system

Rigid PVC rubrail with vinyl insert

Stainless steel upholstery staples

Steel-reinforced molds

Stern eyes

Tapered prop shaft coupler with locknut

Transferable hull and structural components limited lifetime warranty

Wiring harness with color-coded and labeled wires

Automatic/manual bilge pump system

Bilge blower

Engine warning light

Fire extinguisher

Flotation meeting USCG requirements

Horn

Inland lighting

NMMA-certified for safety

Safety engine stop switch

AWSA Endorsed

Adjustable oversized windshield mounted convex mirror w/bracket, removable

Anodized aluminum ski pylon

Stainless steel pop-up and pull-up cleats

Speedometer

Wear-Guard ski pylon, patented

X-30 OPTIONAL EQUIPMENT

MasterCraft Power Cadillac Northstar
phased port EFI, 32-valve, 4.6 liter
V-8 engine—320 hp, includes closed
cooling system) *Limited Availability*
MasterCraft Power Vortec MX LT-R 5.7L
multi-port EFI 350 cubic inch GM
V-8 engine—330 hp
Closed cooling system (not available
with shower. Standard on Cadillac
Northstar engine)
European-certified package
Bimini top (dealer installed)
Boat cover
Bow tonneau cover (dealer installed)
Cockpit mooring cover (dealer installed)
Sun top (dealer installed)
Boat house cradle—galvanized
Fiberglass swim platform—removable,
ivory
Heater
Six-disc CD changer
Perfect Pass cruise control
Perfect Pass Wakeboard
Pressurized hot/cold shower (not
available with closed cooling system or
Northstar engine)
Extended warranty
Cockpit table, stowable with drink holders

ZeroFlex Flyer
ZeroFlex Flyer boat cover
Tower lights
Tower speakers
Two board racks (holds four boards)
Metal flake gel coat
Rearrangement of upholstery colors
Wireless headphone system
Raised platform
Bow filler cushion
Message center
High-volume air pump
Binding Blaster Soap Pump
Tandem axle trailer with disc brakes
Galvanized tandem axle trailer with
disc brakes
Pivot tongue on trailer, standard
Spare trailer tire—aluminum or galvanized
Canadian trailer specifications

Speedometer . . . The speedometer indicates the forward speed of the boat in miles per hour (unless your boat is equipped with the kilometers per hour available in the European Package). Tournament boats feature dual speedometers, which are required for some tournaments in case of a failure during a run. The speedometer calibration switches are located on the lower starboard panel on these boats.

Because the MariStar line also serves as pleasure boats, they are equipped with a single speedometer, and the calibration switch is located on the middle starboard panel.

For tournament use and practice, accurate speedometer readings are a must. Even if you are not involved in pulling tournament skiers, you may be concerned about having accurate readings.

To calibrate the speedometer you need an accurately measured course of 850 feet and a certified stopwatch accurate to within one-thousandth of a second. To calibrate to AWSA official-tournament rules:

- Approach the course at an indicated 36 miles per hour (MPH). Hold the speed steady and have an observer check the course time with a stop watch.
- If the course time is between 15.88 and 16.28 seconds, no adjustments are necessary.
- If the course time is not within tolerance, press up or down on the calibration rocker switch to adjust the calibration.

Tachometer/Engine Hourmeter . . . The tachometer indicates the engine speed in crankshaft revolutions per minute (RPM). Propeller shaft RPM is the same as the engine except for boats equipped with the Power



Slot™ 1.5-to-1 ratio package, in which case propeller shaft RPM is less than that of the engine RPM. The engine hourmeter registers accumulated engine operating time. Use the hourmeter to keep accurate logs for scheduled maintenance.

Fuel Gauge . . . The readers are only approximate and should be compared to the hours of operation multiplied by the known fuel consumption (gallons-per-hour or GPH). The gauge is activated with the ignition switch. Rocking motion of the boat during normal operation will cause fluctuation of the fuel gauge. For a more accurate reading, make sure that the boat is level and at rest.

Although it may be possible to see fuel in the bottom of the fuel tank, you may not be able to operate the boat. The fuel pickup system was designed to avoid introducing the water and debris that inevitably accumulate in the bottom of the tank. Rather than relying on visual inspection, you should pay attention to the fuel gauge and your GPH.

Temperature Gauge . . . The engine temperature gauge indicates the cooling water temperature inside the engine as measured in

Controls and Indicators

degrees Fahrenheit.

The normal operating temperature will range from 140^o to 190^o. Engines with electronic fuel injection also have a control circuit inside the engine control module that will cause the engine to run at reduced speeds if the module senses that the engine is running too hot. If you notice that your speed has reduced during normal operation without reducing the throttle, monitor your temperature gauge. If the gauge indicates excessive temperatures during operation, slow down immediately and turn off the ignition.

Caution: Continuing to operate the boat while the temperature is above normal operating parameters may cause serious damage to your engine.

NOTE: Damage to your engine from neglected action while running too hot can be costly. It is not covered by your warranty!



Engine Oil Pressure Gauge . . . The engine oil pressure gauge indicates the pressure of the lubricating oil inside the engine. The average pressure ranges are between 6 pounds-per-square-inch (PSI) at 1000 RPM to 40 PSI at cruise range speeds. A reading of pressures below 5 PSI at 1000 RPM may be caused by a low oil level or other potentially serious problems that result in low oil pres-

sure. If you experience low oil pressure, stop your engine immediately and check your oil level before operating again.

Caution: Do not continue to run the engine if the oil pressure is low. If you do, the engine can become so hot that it—or surrounding components—could catch fire. You or others could be burned and the boat seriously damaged. Check your oil level before operating again or have your boat serviced by your local MasterCraft dealer.

NOTE: Damage to your engine from neglected oil problems can be costly. Such damage is not covered by your warranty!

Check Engine Light . . . The red malfunction indicator Check Engine light operates from an on-board computer that monitors the operation of your fuel, ignition and engine control systems.

On some models, the Check Engine light should come on when the key is in the ON position and the engine is not running. This is a check to show you that it is working. If it does not come on at all, have it repaired by your MasterCraft dealer right away.

If it stays on—or comes on while you are operating your boat—the computer is indicating that you have a problem. You should take your boat to your MasterCraft dealer for immedi-

ate service.

The Check Engine light is supplemented with a warning buzzer that sounds when the key is in the ON position and the engine is not running, or when one of a number of issues arises with the engine that may require mechanical service.

NOTICE: If you continue to operate your boat with this light on, you could

adversely affect the emission control systems on the engine. You could also experience poor fuel economy, and your engine may not run as smoothly. This could lead to costly repairs not covered by your warranty.

Ignition Switch . . . Never leave the ignition switch in the RUN position without the engine running; this will prevent the natural discharge of the battery.

Safety Switch . . . The emergency engine safety switch, called the lanyard, is an ignition cut-off switch designed to stop the engine in the event of an operator being thrown from position or moving too far from the helm.

The lanyard is equipped with a hook on one end for attachment to your clothing, and the opposite end has a slide that fits over the switch. Be sure that the slide is firmly attached to the switch before starting. The switch is located on the throttle control box. *If the slide is left off or loose, the engine will crank but will not start.*

Warning: The safety switch lanyard must be attached to the operator whenever the engine is started. Failure to do so may cause serious injury or death.

Blower Switch . . . A two-position rocker switch activates the engine box ventilation blower. Push the top half of the switch to turn the blower ON.

NOTE: The blower must be operated for a minimum of four (4) minutes before starting the engine at any time. The blower must also be operated during idle and slow-speed running, but is not necessary at cruising speed.

Warning: Failure to operate the blower as instructed could cause improper ventilation of the boat engine and bilge areas. Fuel vapors can accumulate in this area and cause a fire or explosion!

Manual & Automatic Bilge Pump Switch . . . A three-position rocker switch activates the bilge pump. Push the top half of the switch to turn the bilge pump to the manual ON position. Press the switch down to activate the bilge pump for automatic mode while the boat is underway. When the switch is centered, the bilge pump is OFF.

Circuit Breakers . . . All major boat circuits are protected from shorting and overload by re-settable circuit breakers. If a problem develops with one of the following circuits, switch OFF the circuit and wait about one minute. Then push the appropriate breaker button fully and switch ON the circuit. If the circuit continues to trip, there is a problem somewhere that must be attended to immediately. *See your MasterCraft dealer.*

The location of breakers varies by model. In later model boats, a breaker panel is located under the dashboard and breakers are re-set by pushing the appropriately marked button. In earlier models, the breakers may be under the dash, on the engine or elsewhere in the boat.

In some later models there is an additional



breaker panel to assist with the accessory load. If the boat's accessories are not functional, also check and re-set this breaker.

Shift/Throttle Control . . . A one-hand, single-lever control operates as both a gear shifter and a throttle. The lever automatically locks in the neutral position (straight up and down) for safety. The lever can only be moved from neutral by raising the lifter under the ball knob. Shifting is accomplished by moving the lever into the first 45 degrees of travel.

Push the lever forward and pull it back for reverse. By advancing the lever beyond 45 degrees you move from the shifting range to the throttle range.

Never attempt to shift without the engine running.

The shift mechanism of this control can be temporarily disengaged by pushing the silver knob in the side of the throttle handle. This allows the engine to increase RPMs in neutral during warm-up.

Important: Drivers should frequently review the gauges anytime the engine is turned on. Information provided by the gauges may be an early warning of potential problems. Some serious drivetrain problems can be avoided by monitoring the gauges.

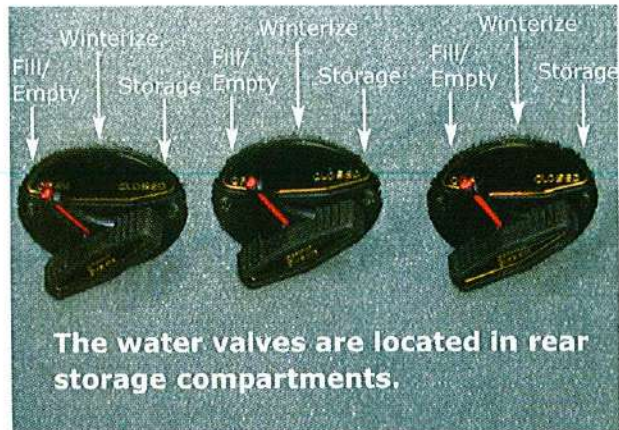

Ballast Systems . . . Ballast systems are comprised of a tank, fill pump, empty pump, valve and a three-position switch. Standard on all X-Series boats and available as options on other models are one of three ballast systems.

The MTS Ballast System was developed for the ProStar 190 EVO and the 19 Skier. It features a tank under the observer seat, which allows for improved balance and better weight distribution. On these models, only the fore switch is active, and there is only one valve in the storage compartment.

The Rear Ballast System is featured on the X-5 and ProStar 195. Only one switch and valve are active in these models, as well as the ProStar 209 and the X-9.

The KGB System with double saddle tanks is standard on the X-Star, X-10 and X-30 models, and available as an option on the ProStar 205 VRS, the MariStar 210 and the MariStar 230. All three switches and all three valves are active in this system.

Operations of Ballast Systems . . .

1) Turn the rear valve(s) as far counterclockwise (left) as possible. This will open the valves to allow water to enter the tanks and bags and not drain out. **It is important to turn them all the way as it activates the check valve!**

2) Using the three-position rocker switches beside the driver, push the top of the switch to operate the pump. Filling of the tanks will



required about 8-10 minutes. Water will come out the vent fittings when the tanks are full.

3) Return side switches to the neutral or middle position.

4) **Check that all bags and tanks have been filled before operating. Failure to do so may result in difficulty controlling the boat while in operation or pitching the boat to a degree that allows excess water into the the boat and thereby creating a situation that could result in sinking of the boat. These situations are considered operator error and may void your warranty.**

5) Before docking and loading your boat, empty the tanks and bags by pressing on the bottom of the three-way switch. This activates the pumps to empty the bags. **It is important that you do this as leaving water in the bags will exceed the weight limits of your trailer. It could also cause an erroneous weight distribution that takes too much weight off the tongue of the trailer and places at the rear. This may result in an ill-handling trailer with potentially danger consequences. Always release all water from the tanks and bags before loading your boat.** Close the valves.

6) If you leave your boat docked in the water, you should also empty the tanks and bags, and close the valves. You do not want to leave the pumps running much longer than

necessary as it places unnecessary wear on the pumps to continue running after the tanks are empty.

Winterizing Ballast Systems . . . You must make sure that **all** water is out of the system. In addition to the steps listed previously, elevate the bow of the boat slightly. (This can be done while the boat is on the trailer by cranking up the flip-up jack on the front of the trailer. It is not necessary to elevate a great deal, but you will need to have about a 5-to-10-degree plane from bow to stern.

Then turn the valves in the storage compartment to 12-o'clock. However, at 12 o'clock, the check valve is not in operation. With the boat's bow slightly elevated any water not pumped out of the ballast system can be gravity-pulled out through the valves. When the valves are turned all the way counterclockwise (approximately 10-o'clock), the check valve operates to keep excess water out of the system and holds water in the tanks and bags.

It is extremely important that you close the valves after this operation and that you never leave the valves at the 12 o'clock position when the boat is in operation!

Even after this, a small amount of water could be left in the system. Disconnect all of the quick-connect systems at the all of the pumps. This is a function best performed by your MasterCraft dealer, in part because when they are re-connected the rings must be secured to avoid leakage.



On reconnection, the prongs will have to be squeezed to slide back on and the red ring must go over the raised ring.



**MasterCraft Power Vortec
MX Predator 5.7L TBI EFI
GM V-8 Engine**

Displacement**350 C.I.D. (5.7 Litres)—**
**310 horsepower**
 Bore**4.00"**
 Stroke**3.48"**
 Compression Ratio**9.4:1**
 Compression Pressure**180-200 psi**
 Maximum Allowable Compression Variation
**Highest to lowest within 75%**
 Maximum Allowable RPM at WOT
**4200-5000 RPM**
 Oil Pressure (Hot)**40 PSI at 2000 RPM**
 Propshaft Rotation**LH**
 Fuel Requirement**89 Octane**
 Fuel Pressure: Operating Pressure**20-30 PSI**
 Fuel Pump Volume**1 pint in 20 seconds**
 Type of Fuel Induction
**Marine Electronic Fuel Injection**
**Throttle Body Type**
 Electrical System**12 Volt**
 Ignition Type**Distributor HEI**
 Electronic Control Module
**Delco Electronics Waterproof**
Marine Controller (MEFI 3/CEFI 3)
 Alternator Output Rating
**51 amps at 2200 RPM**

Thermostat**160 degrees**
 Spark Plug Type**AC MR43LTS**
 Recommended Plug Gap**0.045"**
 Firing Order**1-8-4-3-6-5-7-2**
 Recommended Battery Rating
525 cold cranking amps for 30 sec
at 0 degrees Fahrenheit
 Oil Capacity**4-5 quarts with filter change—**
**verify with dipstick**
 Oil Type**SAE 15W-40, CG-4SJ**
 Oil Filter Type**PF25 or PZ3**
 Transmission Fluid Capacity
**1-1/2 to 2 qts with 1:1 transmission**
2-1/2 to 3 qts with 1.5:1 transmission
 Initial Timing
**10 degrees BTDC at 1000 fixed RPM**
 Total Ignition Advance
**Varies as a function of input information**
 Cylinder Numbering Front to Rear
**Left bank 1-3-5-7**
Right bank 2-4-6-8



**MasterCraft Power Vortec
MX LTR 5.7L Multi-port EFI
GM V-8 Engine**

Displacement**350 C.I.D. (5.7 Litres)—**
**330 horsepower**
 Bore**4.00"**

Specifications

Stroke **3.48"**
 Compression Ratio **9.4:1**
 Compression Pressure **180-220 psi**
 Maximum Allowable Compression Variation
 **Highest to lowest within 75%**
 Maximum Allowable RPM at WOT
 **4800-5200 RPM**
 Oil Pressure (Hot) **40 PSI at 2000 RPM**
 Propshaft Rotation **LH**
 Fuel Requirement **89 Octane minimum**
 Fuel Pressure: Operating Pressure . . . **35-45 PSI**
 Fuel Pump Volume **1 pint in 20 seconds**
 Type of Fuel Induction
 **Marine Electronic Fuel Injection**
 Direct Port Type
 Electrical System **12 Volt**
 Ignition Type **Northstar LSI multi-coil**
 Electronic Control Module
 **Delco Electronics Waterproof**
 Marine Controller (MEFI 3/CEFI 3)
 Alternator Output Rating **51 amps at 2200 RPM**
 Thermostat **160 degrees**
 Spark Plug Type **AC MR43LTST**
 Recommended Plug Gap **0.045"**
 Firing Order **1-8-4-3-6-5-7-2**
 Recommended Battery Rating
 **525 cold cranking amps for 30 sec**
 at 0 degrees Fahrenheit
 Oil Capacity . . . **4-5 quarts with filter change—**
 verify with dipstick
 Oil Type **SAE 15W-40, CG-4SJ**
 Oil Filter Type **PF25 or PZ3**
 Transmission Fluid Capacity
 **1-1/2 to 2 qts with 1:1 transmission**
 2-1/2 to 3 qts with 1.5:1 transmission
 Initial Timing
 **10 degrees BTDC at 1000 RPM fixed**
 Factory set—Not field adjustable
 Total Ignition Advance
 . . . **Varies as a function of input information**
 Cylinder Numbering Front to Rear
 Left bank 1-3-5-7
 Right bank 2-4-6-8

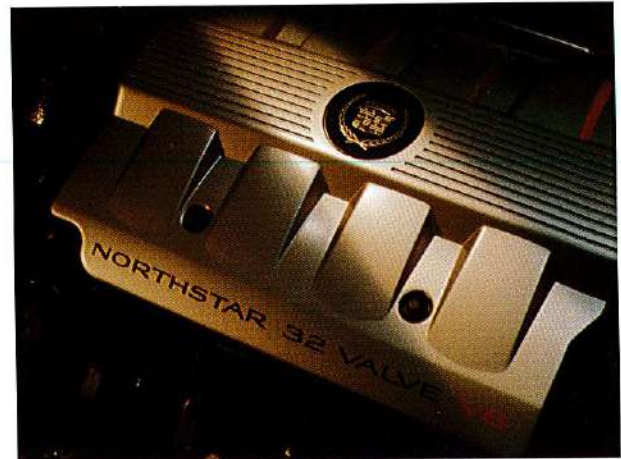

**MasterCraft Power/
 Cadillac Northstar
 Phased-port EFI, 32-valve
 V-8 Engine**
 Displacement **279 C.I.D. (4.6 Litres)—**
 320 horsepower at 6000 RPM
 Torque **318 lb-ft @ 4500 RPM**
 Bore **3.66"/93 mm**
 Stroke **3.31"/84 mm**
 Camshafts **DOHC (4 valves/cyl)**
 Intake Valves **16 (1.30"/33 mm)**
 Exhaust Valves **16 (1.14"/29 mm)**
 Valve Lifters **Direct Acting Hydraulic**
 Cylinder Head Material . . . **Aluminum (Die Cast)**
 Block Material
 . . . **Aluminum (Die Cast) w/cast iron liners**
 Combustion Chamber Volume **51.8 cc**
 Compression Ratio **10.3:1**
 Compression Pressure **140-170 psi**
 Maximum Allowable Compression Variation
 **Highest to lowest within 75%**
 Maximum Allowable RPM at WOT
 **5800-6200 RPM**
 Oil Pressure (Hot) **35 PSI at 2000 RPM**
 Fuel Requirement
 **92 Octane (R+M)/2 (RFG acceptable)**
 Fuel Pressure: Operating Pressure . . . **43-53 PSI**
 Fuel Pump Volume **1 pint in 20 seconds**
 Type of Fuel Induction
 **Marine Electronic Fuel Injection**
 Phased Port Type
 Electronic Control Module
 **Delco Electronics Waterproof**
 Marine Controller (MEFI 3/CEFI 3)
 Ignition System **Northstar Multi-Coil LSI**

Alternator Output Rating
**.51 amps at 2200 RPM**
 Thermostat**.160 degrees**
 Spark Plug Type**AC 41-950**
 Recommended Plug Gap**0.050"**
 Firing Order**1-2-7-3-4-5-6-8**
 Recommended Battery Rating
**.525 cold cranking amps for 30 sec**
**at 0 degrees Fahrenheit**
 Oil Capacity**7.5 quarts with filter change**
**(8.5 w/cooler)—verify with dipstick**
 Oil Type**SAE 15W-40, CG-4SJ**
 Oil Filter Type**PF 58**
 Transmission Fluid Capacity
**2-1/2 to 3 qts with 1.5:1 transmission**
**or V-drive transmission**
 Initial Timing
**Factory-set and computer-controlled—**
**Not field adjustable**
 Total Ignition Advance
**Varies as a function of input information**
 Cooling System—Engine/Fresh Water (closed)
**12 qt. 50/50 Propylene Glycol & Water**
 Cooling System—Engine Oil/Transmission
**Raw Water—Full Flow Tandem**
 Pump Capacity—Raw**25 GPM**
 Pump Capacity—Circulating**104 GPM**
 Propshaft Rotation**LH**
 Cylinder Numbering Front to Rear
**Left bank 2-4-6-8**
**Right bank 1-3-5-7**

Propellers

19 Skier

MX Predator w/Hurth 1:14-blade 13"x14"

ProStar 195 and X-5 Wakeboard

MX Predator w/Hurth 1:14-blade 13"x14"

MX Predator w/Hurth 1.5:14-blade 14"x20"HC

MX LTR w/Hurth 1:14-blade 13"x13" LC

MX LTR w/Hurth 1.5:14/-blade 14"x18" LC

ProStar 190 EVO

MX Predator w/Hurth 1:14-blade 13"x14"

MX Predator w/Hurth 1.5:14-blade 14"x20"HC

MX LTR w/Hurth 1:14-blade 13"x13" LC

MX LTR w/Hurth 1.5:14/-blade 14"x18" LC

ProStar 209 and X-9 Wakeboard

MX Predator w/Hurth 1:14-blade 13"x14"

MX Predator w/Hurth 1.5:14-blade 14"x16"

MX LTR w/Hurth 1:14-blade 13"x13" LC

MX LTR w/Hurth 1.5:14-blade 14"x20" LC

ProStar 205VRS & X-Star

MX Predator w/Hurth 1.5:14-blade 14"x20" HC

MX LTR w/Hurth 1.5:14-blade 14"x18"

MariStar 210, 230, 230SV, X-10 and X-30

MX Predator w/Hurth 1.5:14-blade 14"x20" HC

MX LTR w/Hurth 1.5:14-blade 14"x18"

MasterCraft Limited Warranty Statement

1. Limited Warranty and Term.

MasterCraft warrants to the original retail purchaser that the following components of each new boat shall be free from material defects in materials and workmanship to the extent set forth below, under normal use and when operated and maintained in accordance with MasterCraft's instructions, for the period indicated:

- (a) **Deck, Hull, Liner and Stringers** — From the date of the original retail purchase, the deck, hull, liner and stringer system (collectively, "Structural Components") is warranted for as long as the original purchaser owns the boat.
- (b) **Gel Coat** — The gel coat is warranted to be free from blisters, fading, cracking and bubbling, as defined by the gel coat manufacturer, for a period of two (2) years from the date of the original retail purchase of the boat.
- (c) **Engine/Transmission** — Three (3) years from the date of the original retail purchase of the boat. The engines used in MasterCraft boats are supplied by Indmar Products Company, Inc., in Millington, Tennessee ("Indmar"). Indmar's three-year warranty on the engine and transmission is administered by MasterCraft and is subject to the terms and conditions set forth below under "Power Train Warranty."
- (d) **Other Component Parts** — One (1) year from the date of the original retail purchase of the boat.
- (e) **Trailer and Trailer Component Parts** — One (1) year from the date of the original retail purchase of the boat.

2. Warranty Conditions, Limitations and Exclusions. MasterCraft boats are manufactured by trained craftsmen from high-quality materials and components. However, conditions outside of MasterCraft's control require specific limitations on, and exclusions from, coverage under this warranty. The Limited Warranty on the Structural

Components set forth in Section 1(a) above does not cover or include the gel coat, including any discoloration, blisters, bubbles or cracks of the gel coat, or any other components fastened or applied to the hull or deck. Furthermore, the Limited Warranty set forth in Section 1 (including all subsections) above does not cover the following:

- (a) damage caused by misuse, negligence, accident, collision or impact with any object;
- (b) damage caused by any improper alteration or modification to the boat or any of its component parts or accessories, including damage resulting from alteration, modification, repair or replacement in such a way as to increase the cubic-inch capacity or horsepower output of the engine and boat as originally manufactured;
- (c) damage caused by the use of improper or contaminated fuel or fluids;
- (d) damage caused by the use of customer-applied chemicals or accidental spills;
- (e) damage caused by failure to maintain the boat in accordance with the maintenance provisions in the Operations and Maintenance Manual or improper maintenance of the boat;
- (f) damage resulting from use of the boat for any racing, speed, commercial competition or performance demonstration;
- (g) damage resulting from use of the boat for rental or other commercial or industrial purposes;
- (h) damage to hardware and other components fastened or adhered to the hull, deck or liner;
- (i) damage caused by fire, theft, freezing, vandalism, explosion, lightning, hail storms, flooding, or other natural disaster;
- (j) damage to any component parts and accessories not manufactured by MasterCraft, including but not limited to the engine, drivetrain, transmission, propeller, shift and throttle control levers and cables, pumps, blowers, windshields, canvas, upholstery, instrumentation and steering systems; however, such items

Warranties

may be warranted by the individual manufacturer, and if possible, MasterCraft will provide the owner with a copy of the manufacturer's warranty;

- (k) damage to the gel coat due to the owner's failure to reasonably maintain the gel coat finish, including, without limitation, discoloration of the gel coat, as this condition is caused by improper care and maintenance; however, fading and chalking of the gel coat above the water line will be covered, provided the gel coat has been appropriately maintained; and/or
- (l) damage to the trailer and its parts or components due to abrasions, rock chips, rust, improper care or maintenance, or use in salt or brackish water; however, the finishes of galvanized trailers, which are designed for use in salt or brackish water, are warranted to be free from damage resulting from use in salt or brackish water for one (1) year.

3. Disclaimer of Implied Warranties.

THE EXPRESS LIMITED WARRANTY SET FORTH HEREIN IS IN LIEU OF ALL OTHER WARRANTIES AND REPRESENTATIONS, EXPRESS OR IMPLIED, AND TO THE MAXIMUM EXTENT PERMITTED BY APPLICABLE LAW, MASTERCRAFT DISCLAIMS, AND THE OWNER HEREBY EXPRESSLY WAIVES, ANY AND ALL OTHER WARRANTIES OR REPRESENTATIONS OF ANY KIND OR NATURE, INCLUDING, BUT NOT LIMITED TO, IMPLIED WARRANTIES OF MERCHANTABILITY AND FITNESS FOR A PARTICULAR PURPOSE. THIS LIMITED WARRANTY GIVES YOU SPECIFIC LEGAL RIGHTS. YOU MAY HAVE OTHERS, WHICH VARY FROM JURISDICTION TO JURISDICTION.

4. Limitation of Liability.

- (a) **Consequential Damages.** This warranty is for the benefit of the owner and MasterCraft, and shall not create or evidence any right in any third party. To the maximum extent permitted by applicable law, in no event shall MasterCraft be liable for any special, incidental, indirect, or consequential damages whatsoever arising out of the use or inability to use the boat or any component part thereof, even if MasterCraft has been advised of

the possibility of such damages or such damages could reasonably have been foreseen by MasterCraft.

- (b) **Purchase Price Limitation.** In any event, MasterCraft's entire liability under any provision of this Limited Warranty shall be limited to the repair or replacement of the boat or component part or the refund of the purchase price paid by the customer for the boat or component part found to be defective within the applicable warranty period. This shall constitute MasterCraft's sole liability and obligation in the event of any claim arising out of its performance or non-performance of any provision of this Limited Warranty. Because some states and jurisdictions do not allow the exclusion or limitation of liability, the above limitations may not apply to you.

5. Transfer of Limited Warranty. Upon any sale, conveyance or other transfer of the boat or trailer by the original retail purchaser, any remaining unexpired Limited Warranty coverage shall be transferred to the second owner and shall remain in effect for the remainder of the applicable warranty period(s) set forth in Sections 1(b), (c), (d) and (e) above (which warranty periods begin to run from the date of the original retail purchase of the boat or trailer, as applicable, by the original retail purchaser), upon delivery of the warranty transfer card and payment of the applicable warranty transfer fee to MasterCraft. With respect to the lifetime Limited Warranty (granted to the original retail purchaser) on the Structural Components set forth in Section 1(a) above, if the sale, conveyance or other transfer of the boat by the original retail purchaser of the boat by the original retail purchaser, then the warranty on the Structural Components shall be transferred to the second owner and shall continue in effect for a period of ten (10) years from the date of the original retail purchase of the boat by the original retail purchaser. If the sale, transfer or conveyance of the boat by the original retail purchaser occurs more than three (3) years after the date of the original retail purchase of the boat, then the Limited Warranty on Structural Components (as well as all other

warranties) shall be void and shall not be transferable to the second owner.

Only one (1) transfer under the provisions of this Section 5 (from the original retail purchaser to the second owner), within the applicable time period, may be made. In the event of a sale or transfer of the boat or trailer by the second owner to a subsequent purchaser, all coverage under this Limited Warranty shall immediately be terminated and the Limited Warranty shall become null and void. No transfer of this Limited Warranty will operate to extend the warranty periods set forth in Section 2 above. In order to effectuate the transfer of the Limited Warranty, the original retail purchaser and the new owner must properly fill out the warranty transfer card found in the back of the Owner's Manual and deliver the completed card, together with a check made payable to "MasterCraft Boat Company, Inc." in the amount of the warranty transfer fee, via US mail, postage prepaid, to MasterCraft at the address shown on the warranty transfer card. The card and check for the warranty transfer fee must be post-marked within the time period specified above in this Section 5 in order for the warranty transfer from the original retail purchaser to the second owner to be effective.

6. Warranty Claims. Subject to the terms of this Limited Warranty, any covered boat or component part with a material defect in materials or workmanship which is returned to an authorized MasterCraft repair facility or MasterCraft's factory during the appropriate warranty period will be repaired or replaced, at MasterCraft's sole option, without charge to the owner. This provision is subject to the following terms and conditions:

- (a) MasterCraft shall only be obligated to repair or replace those items which prove defective, in MasterCraft's sole discretion, upon examination by MasterCraft's authorized personnel.
- (b) MasterCraft warrants its repairs or replacements only for the remainder of the applicable warranty period.
- (c) MasterCraft shall, in its sole discretion, fulfill its obligation to repair or replace any defective item at its factory or autho-

rized repair facility.

- (d) The owner shall be responsible for all costs associated with the transportation of the boat, trailer or part(s) to the authorized MasterCraft facility and for any return transportation.

7. No Modification of Warranty. No oral or written information, advice or communication of any nature by or from MasterCraft or its representatives, employees, dealers, agents, distributors or suppliers shall create a warranty or in any manner increase or modify the scope of this Limited Warranty.

Power Train Warranty

The following information reflects certain conditions established by the engine manufacturer, which are provided as a guideline for dealers to review. Be advised that the MasterCraft Limited Warranty takes precedence.

MasterCraft Boat Company (Indmar Products Company, Inc.), 100 Cherokee Cove Drive, Vonore TN 37885, administers the Indmar engine warranty on marine propulsion engines sold by it (the "product"):

A. For a period of thirty-six (36) months commencing from the date of purchase or the date of commencement of the product use, whichever occurs sooner, in the case of non-commercial use.

B. For a period of three (3) months commencing from the date of purchase or the date of commencement of the product use, whichever occurs sooner, in the case of commercial use.

These are warranted only in the United States—excluding its territories.

This warranty is granted solely upon the following terms:

A. Persons Applicable

This warranty is extended only to the original retail purchaser, except in instances of a transfer to the second owner only for a fee. Warranties of any nature to any other person are hereby specifically excluded.

B. Implied Warranties

All implied warranties of merchantability and fitness for the particular purpose are

specifically limited in duration to the foregoing periods of this limited warranty. Some states do not allow limitations on how long an implied warranty lasts, so the above limitation may not apply to you.

C. Coverage

The product is warranted to be free from defects in material and workmanship under normal use and service during the period of this Limited Warranty. If the product or defective part thereof is, upon examination, determined to be thus defective, MasterCraft (Indmar) shall repair or, at its option, provide a replacement of equivalent quality (new or rebuilt, at its option).

D. Procedure

For warranty claims to be asserted hereunder, the product or defective part thereof, together with a written notice of itemized defects must be returned to the retailer from whom the product was purchased or to any other convenient Indmar dealer.

To obtain the location of an authorized dealer or service center in your area, write to Indmar requesting such information.

In the event that the local Indmar dealer is unable to remedy a warranty defect in the product, the product or defective part thereof, together with a written notice of itemized defects, must be returned to Indmar at the above address with freight and insurance charges pre-paid.

All insurance and freight charges for return by Indmar of the product (or its substitute) to the original retail purchaser shall be paid by the original retail purchaser.

Expenses for labor incurred by Indmar in the repair of any warranted products shall be paid by the original retail purchaser to the extent that such expenses for labor exceed the specified service rates of Indmar in effect at the date of receipt of the product by Indmar. A schedule of service rates of Indmar may be obtained from any authorized Indmar dealer.

E. Consequential Damages

This warranty shall not extend to consequential or incidental damages or costs incurred by the original retail purchaser. Some states do not allow the exclusion or limitation of incidental or consequential damages, so the above limitation or exclusion may not apply to you.

F. Trade Accessories

No warranty of any character is made with respect to trade accessories not manufactured by Indmar.

G. Voiding Warranty

This warranty is specifically voided and shall *NOT* apply under the following conditions:

- I. When the product or any part thereof is subjected to accident, alteration, abuse, misuse, neglect or improper maintenance.
- II. When the product is serviced by unauthorized persons.
- III. When damage to the product results from causes not arising out of defects in material or workmanship.

Indmar does not authorize any person, firm or corporation to alter this Limited Warranty or create any other obligation relating to the product. This warranty gives you specific legal rights, and you may also have other rights which vary from state to state.

Indmar Products Co., Inc.
5400 Old Millington Road
Millington TN 38053

Warranty Registration

For first purchase of a specific MasterCraft boat, the original owner will receive a warranty registration card to complete and turn in. You should be aware that under federal law, completion of the warranty card is a requirement and should be completed as follows:

1. Dealer must complete the three-part warranty at date of sale, completing the checklist and verifying issues with the customer.
2. Dealer must secure buyer's signature!
3. Dealer provides one copy to the new owner, retains one for the dealership files, and forwards the remaining copy to MasterCraft.
4. Card must be mailed to the manufacturer within three days of the sale.

If the MasterCraft boat is sold, MasterCraft offers a transferrable warranty to the second owner. In accordance with the MasterCraft Limited Warranty, the remaining warranty against structural defect in the hull and deck will be transferred to the new owner when the following has been accomplished and verified:

- Receipt of the completed form below
- Payment of \$450 within fourteen (14) days of the sale date.
- copy of the sales invoice

Upon verification, the remaining warranty will transfer, retroactive to the sale date.

WARRANTY REGISTRATION TRANSFER (forward this copy to MasterCraft)

Boat Serial Number _____ Model Year _____

Engine Make _____ Serial No. _____ Trans Type _____ Serial No. _____

PLEASE PRINT

Previous Owner

Owner's Name

Street Address

City State Zip

Home Phone -- Work Phone --

Date of Purchase Owner Signature _____

(must be signed)

Be sure to enclose payment and a copy of the purchase receipt within 14 days of the sale date.

Warranty Registration & Transfer



19 Skier

ProStar 195

ProStar 190 EVO

ProStar 209

X-5 Wakeboard

X-9 Wakeboard

ProStar 205 VRS

X-Star Wakeboard



MariStar 210

MariStar 230

MariStar 230SV

X-10 Wakeboard

X-30 Wakeboard